



CREATOR

10232



EXPERT



1



2

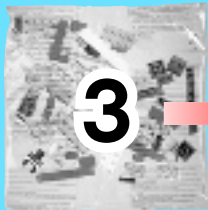

3



LEGO.com/brickseparator



+

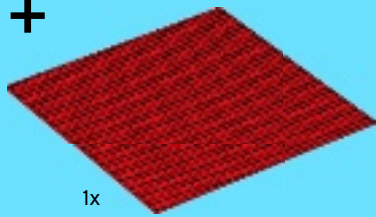

1x

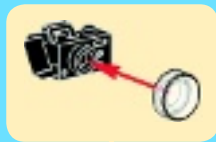
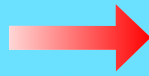

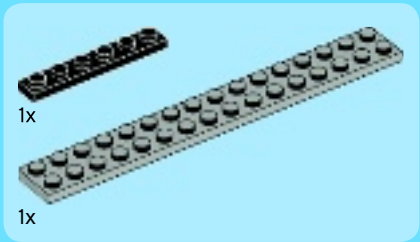

1

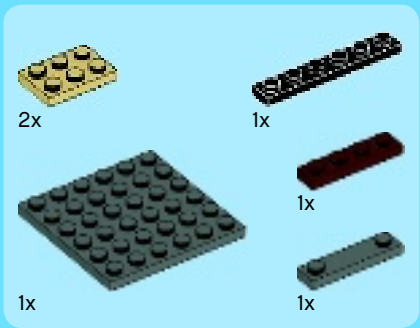
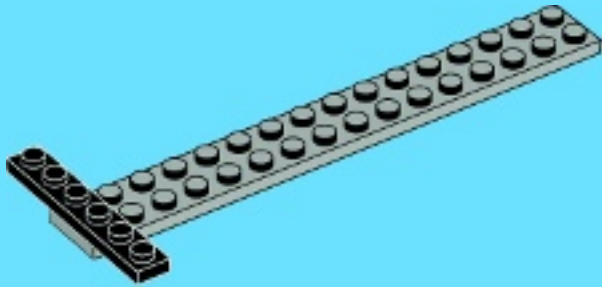

2



4x

2x

3

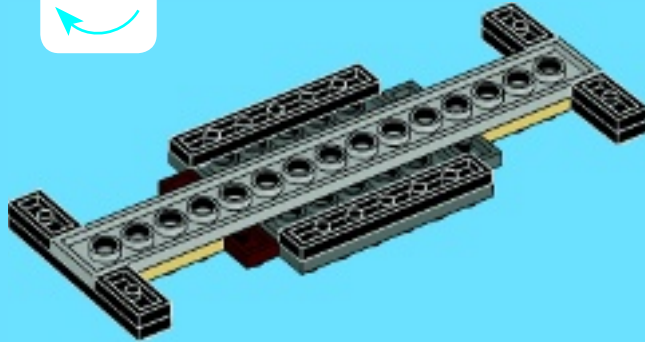

1x



1x



1x



2x

4

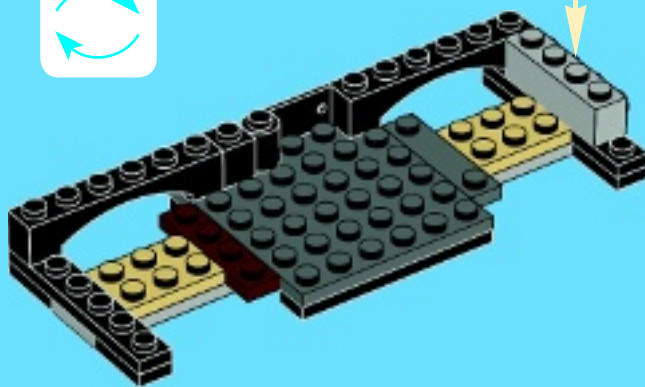
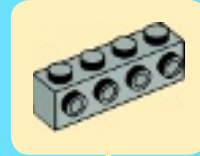



2x



2x



1x



2x



2x

5

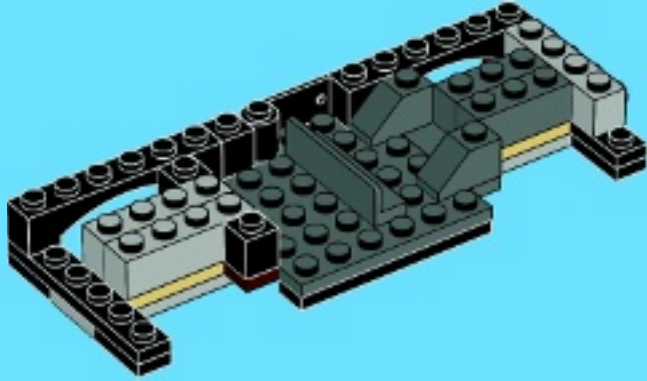

1x



1x



1x



1x



2x



1x



1x

6

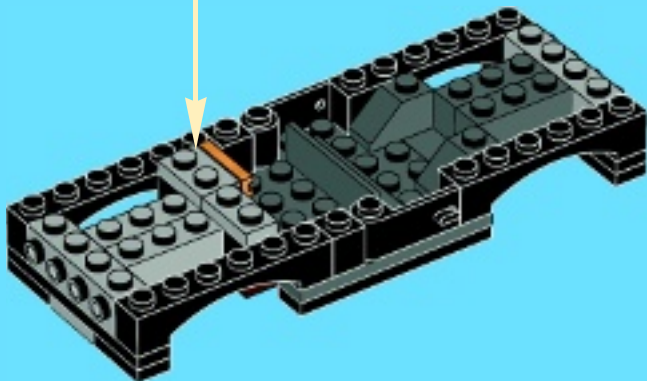
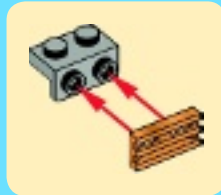

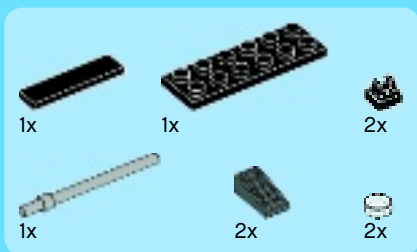

7

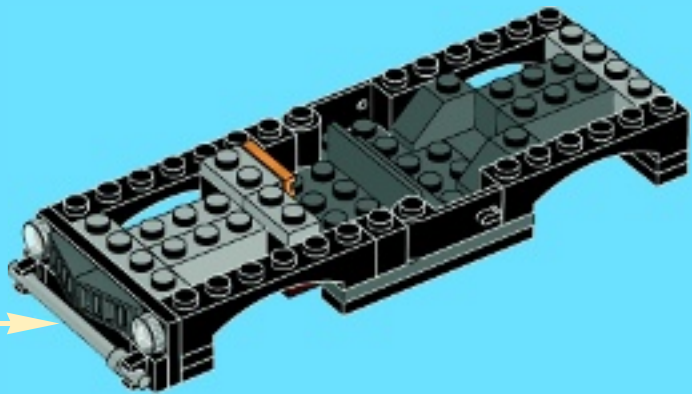
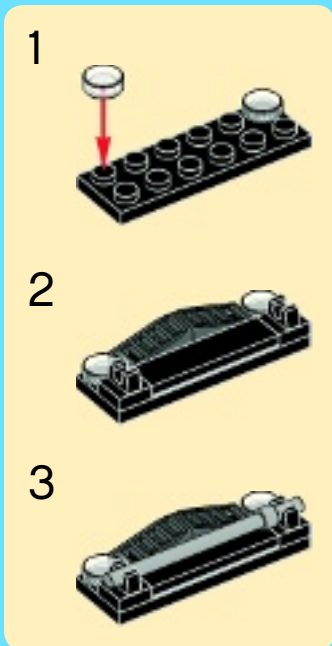

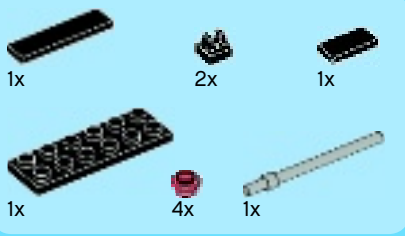

8

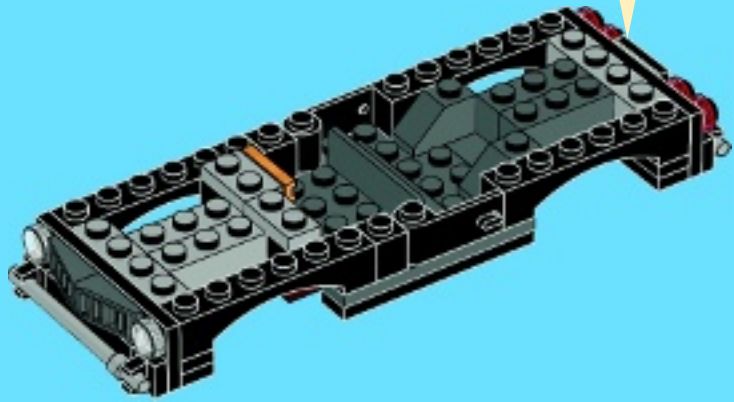
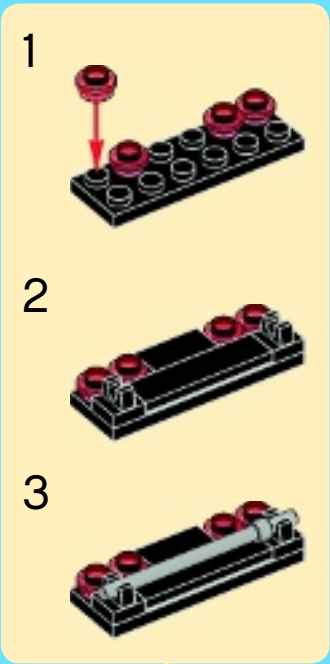



9

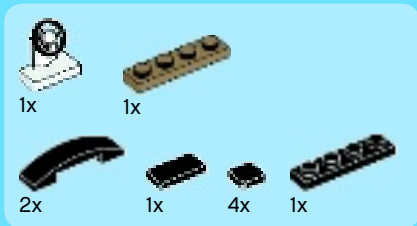
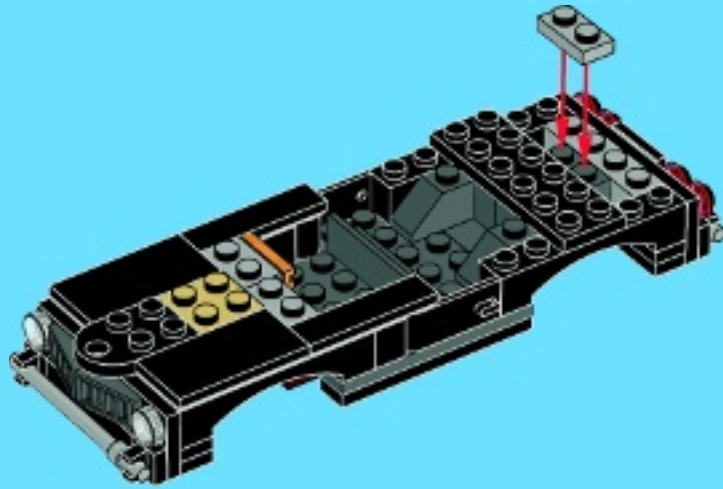

10

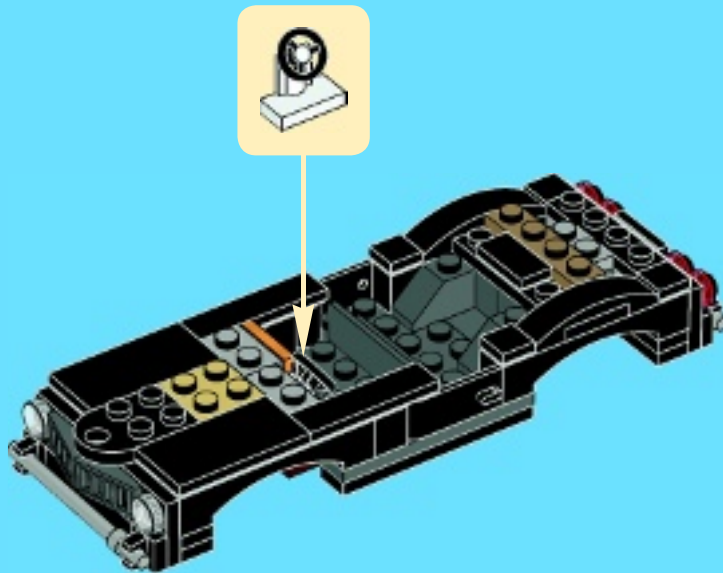

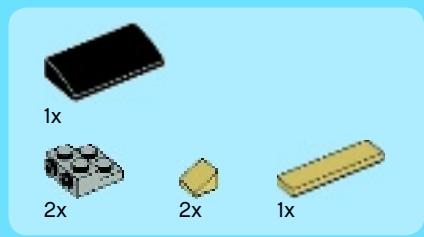

11

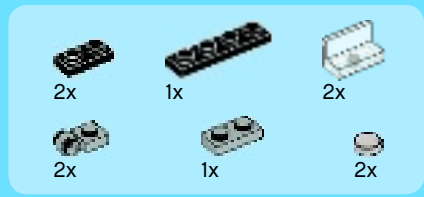
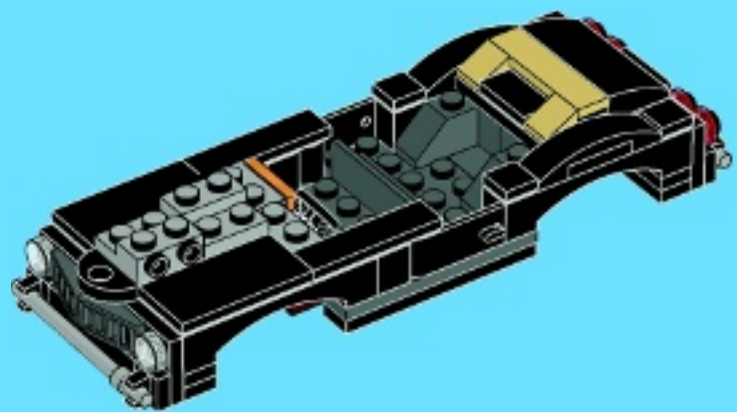

12

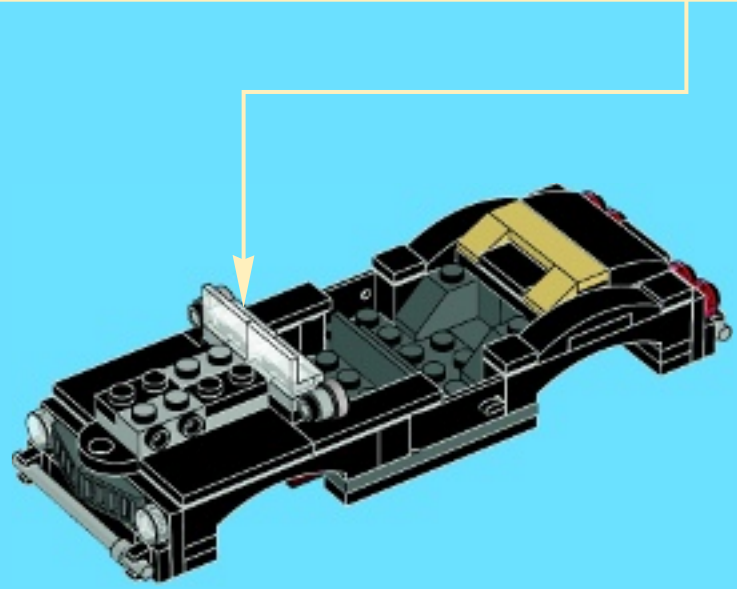

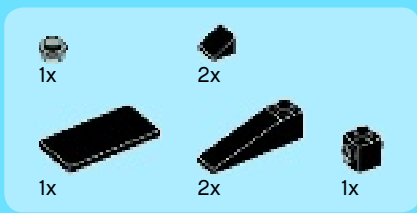

13

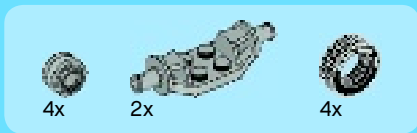
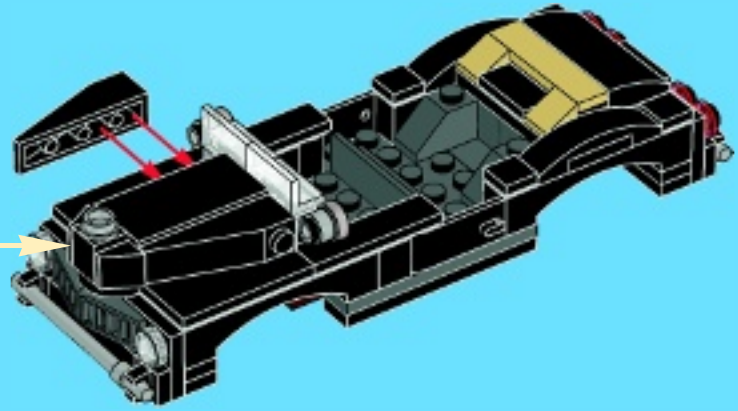
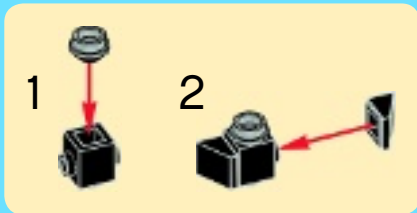

14

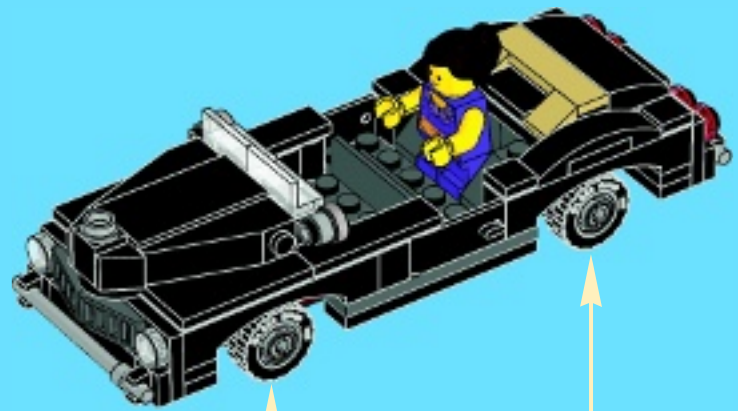
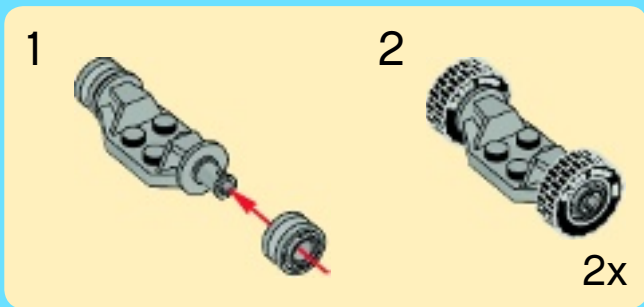



3x



10x

1

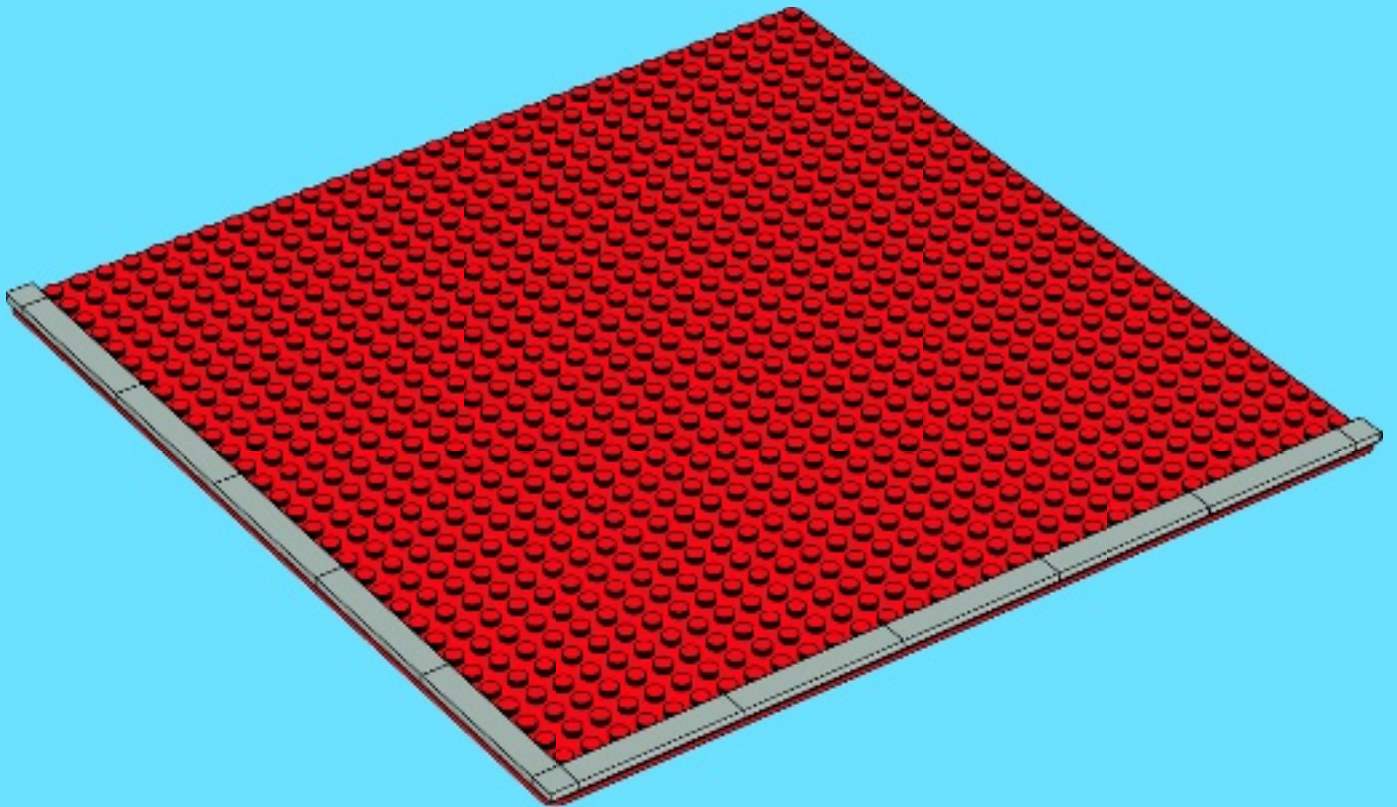

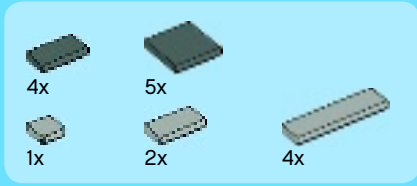

2

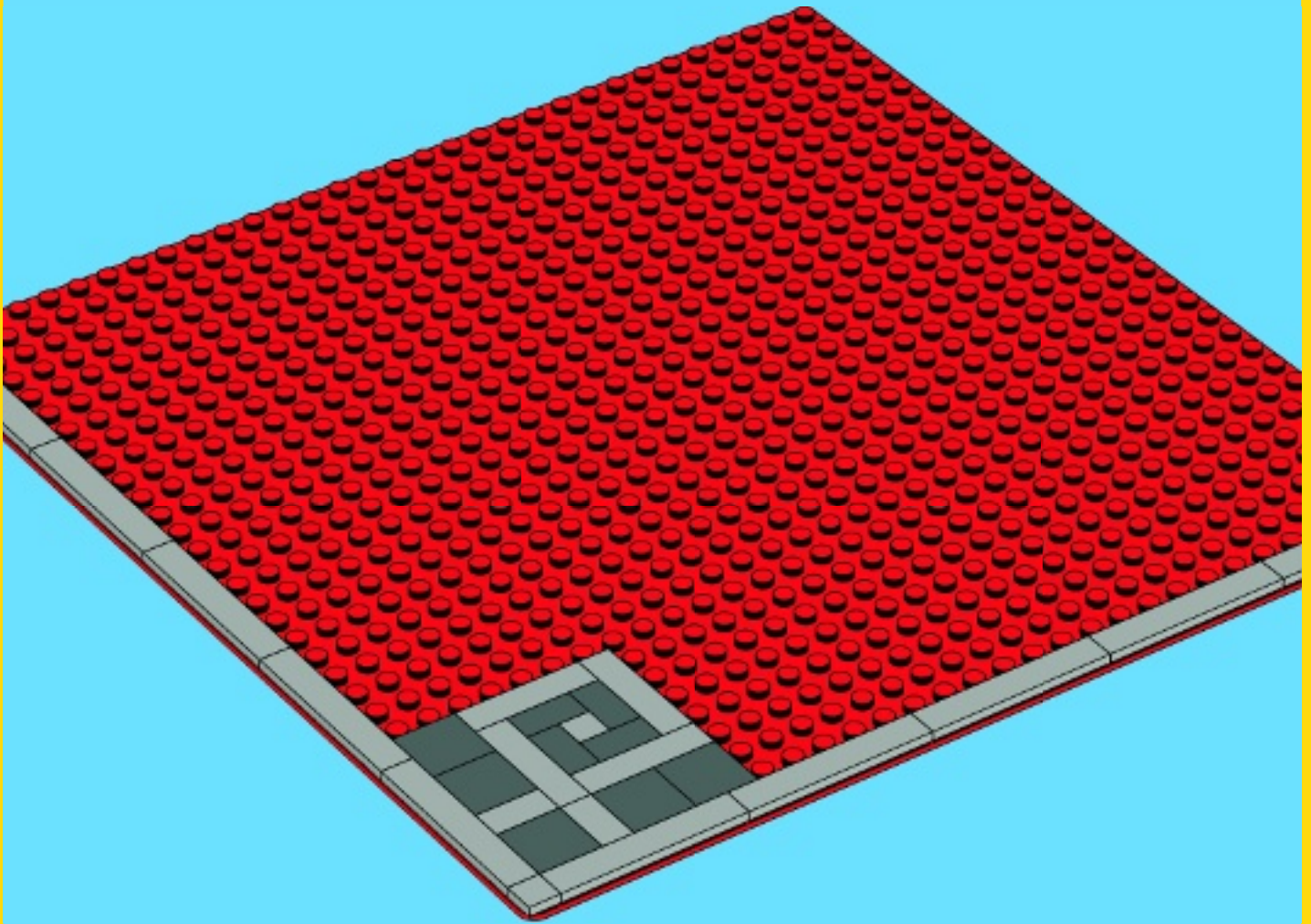

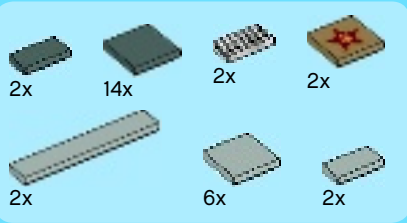

3

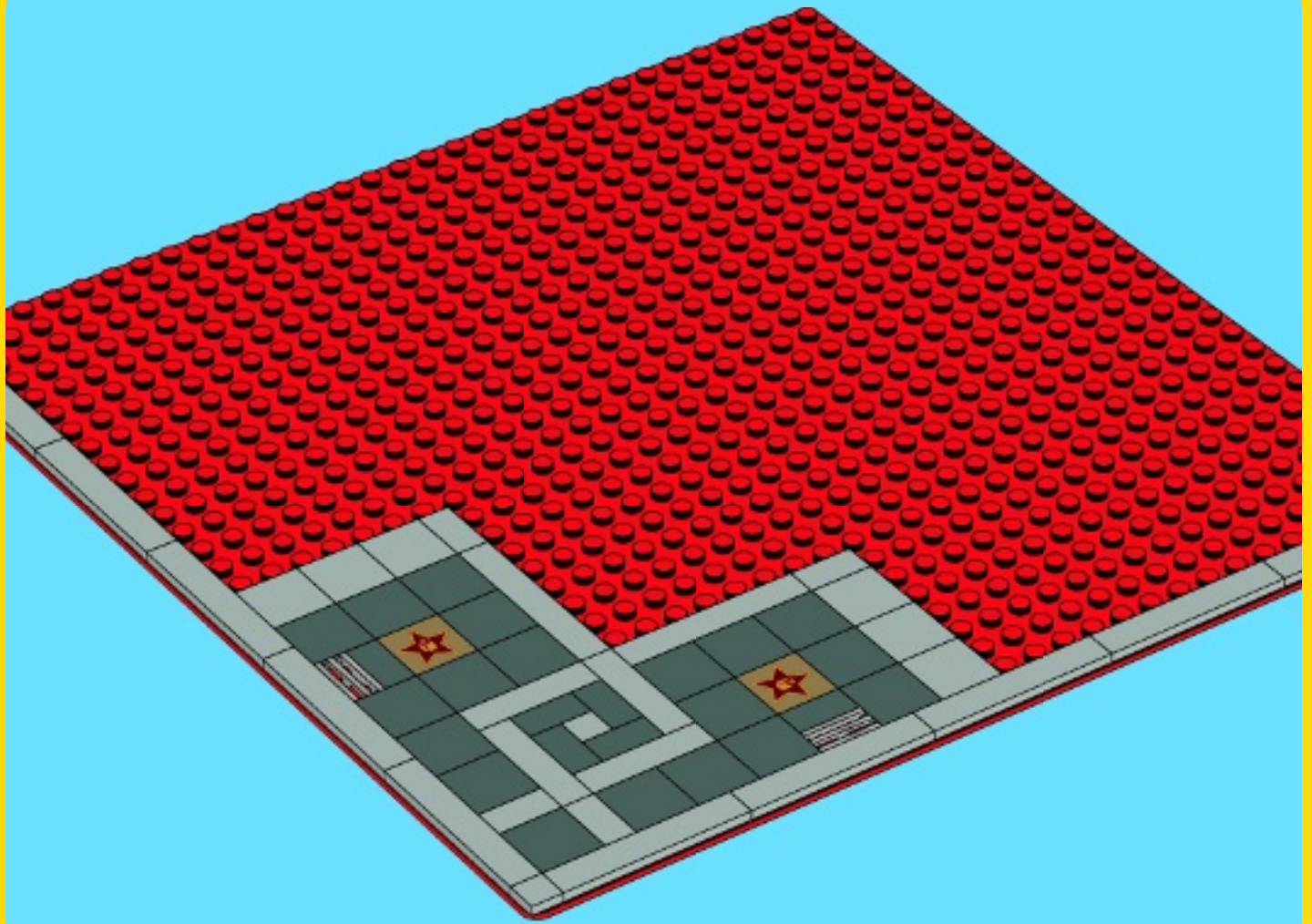

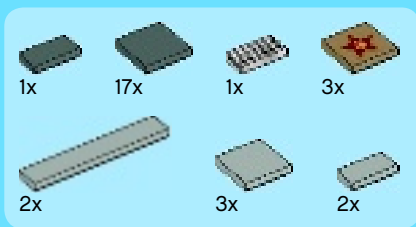

4

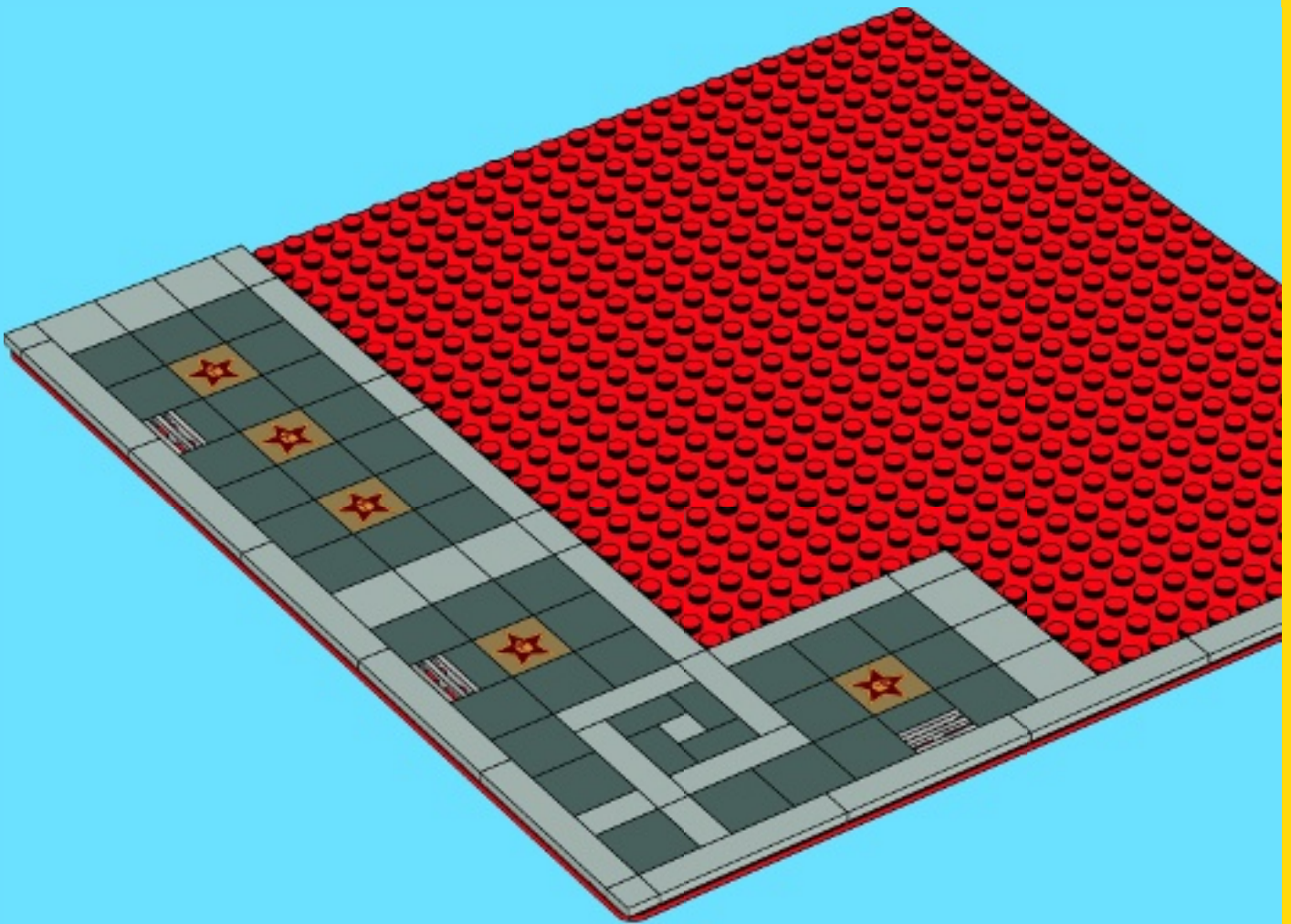

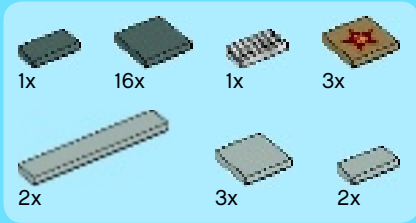

5

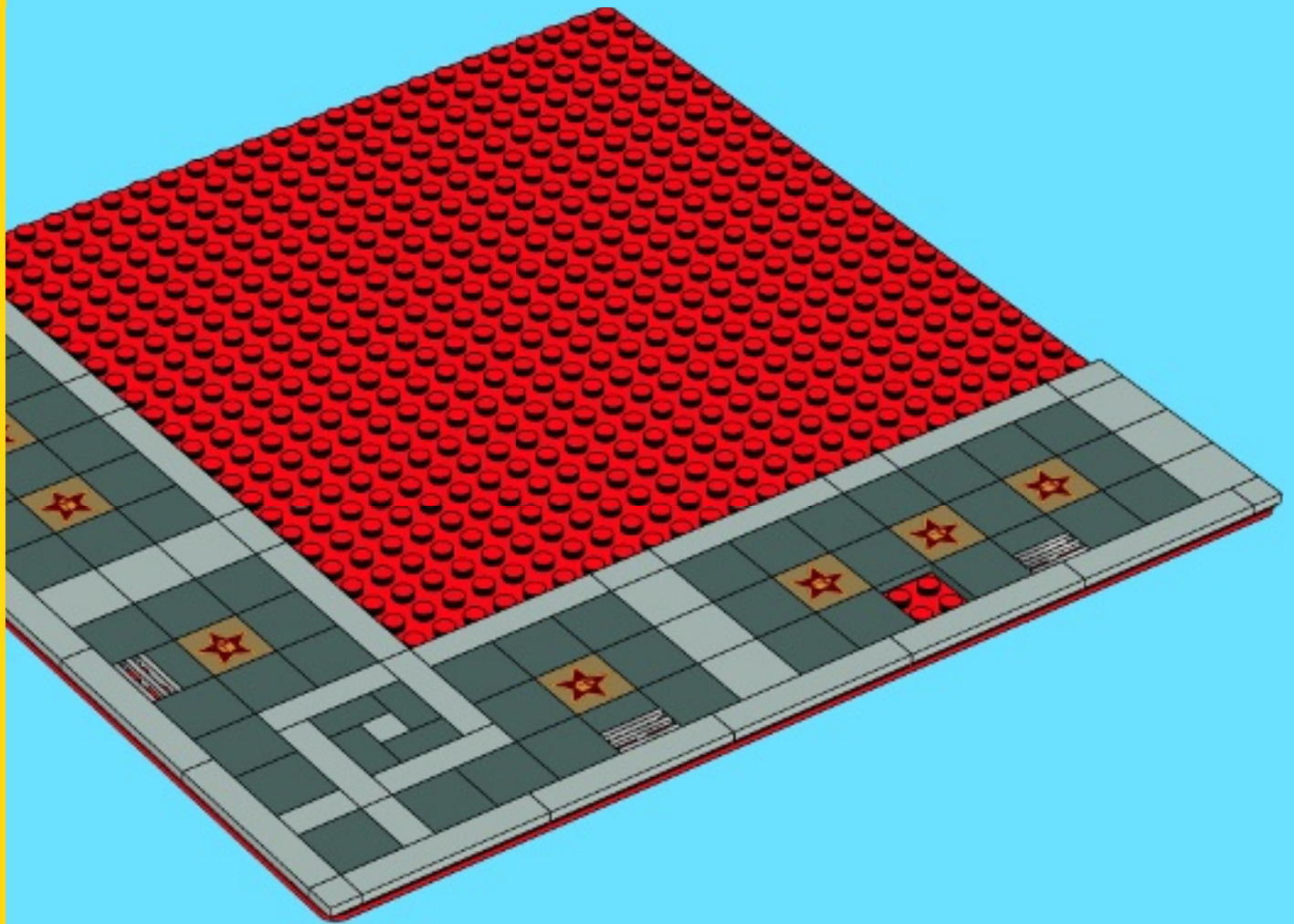

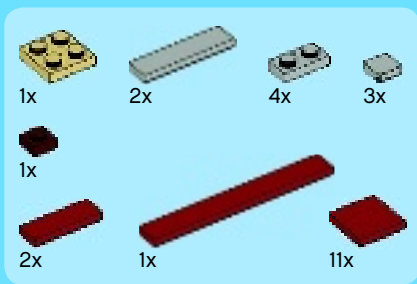

6

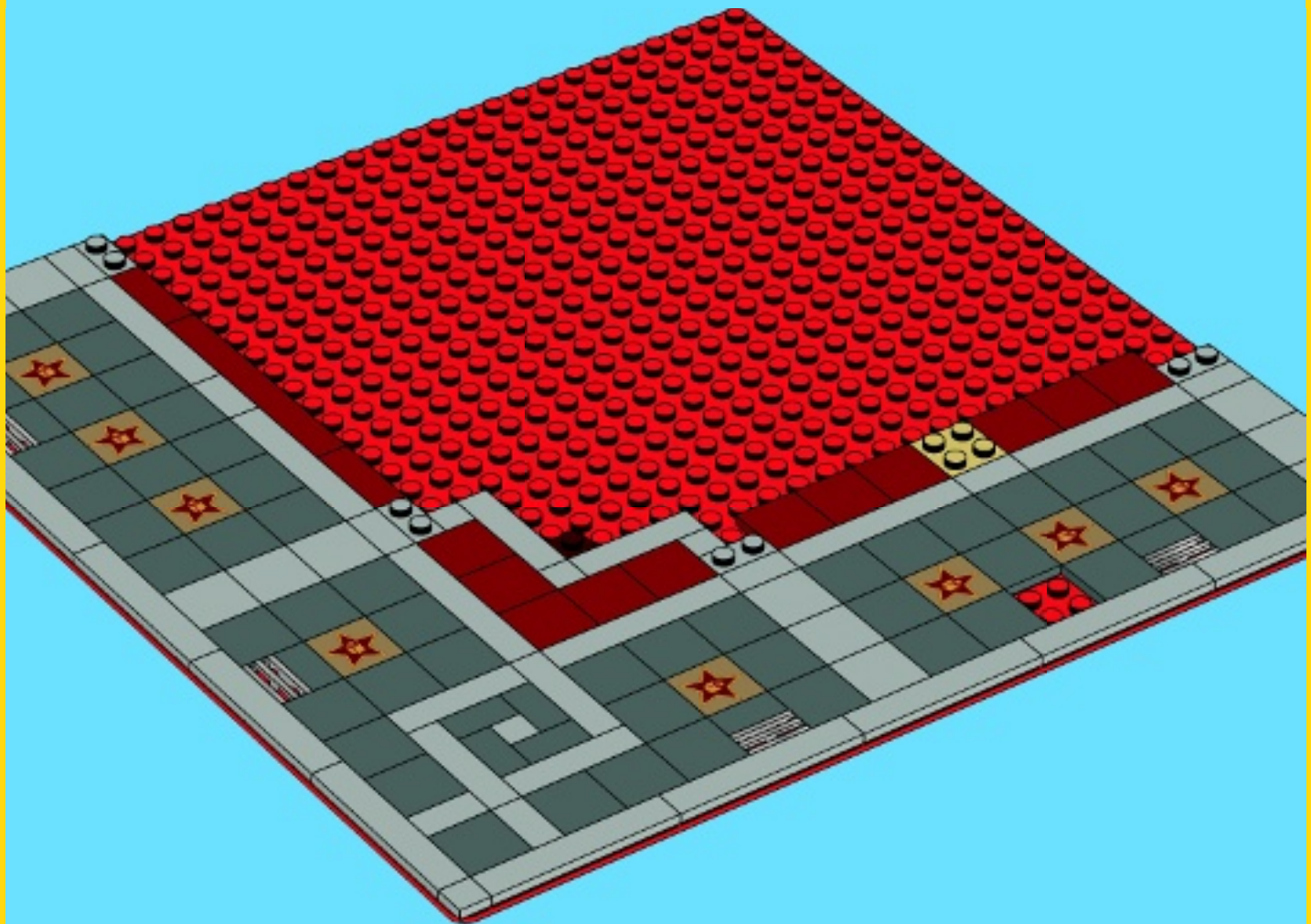

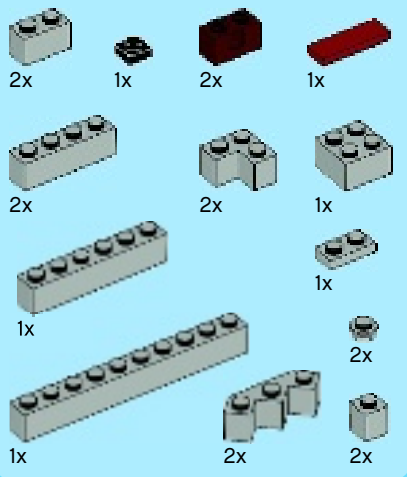

7

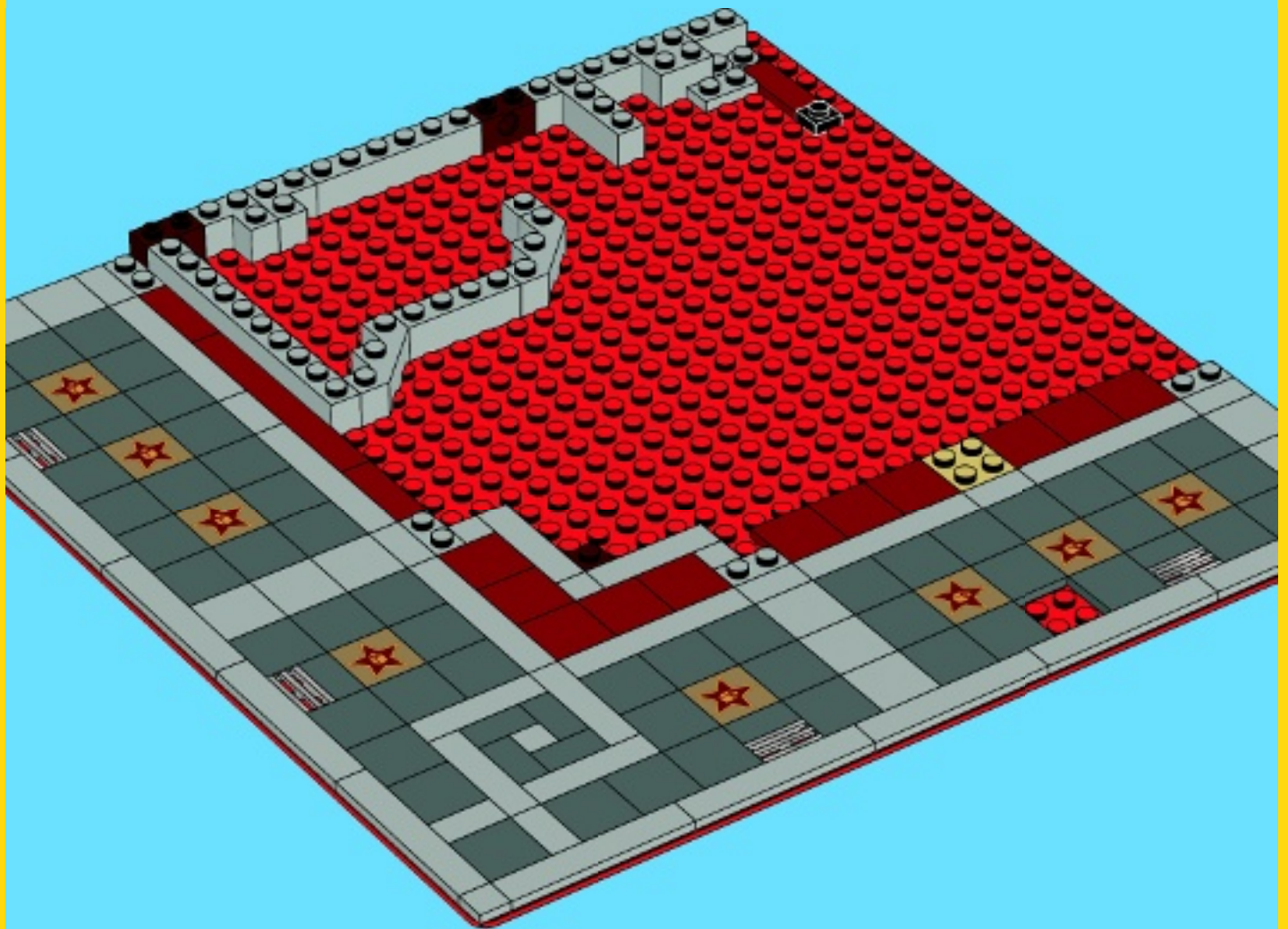

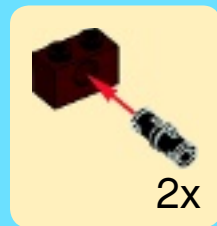
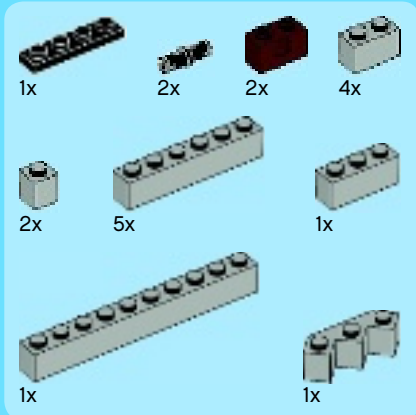

8

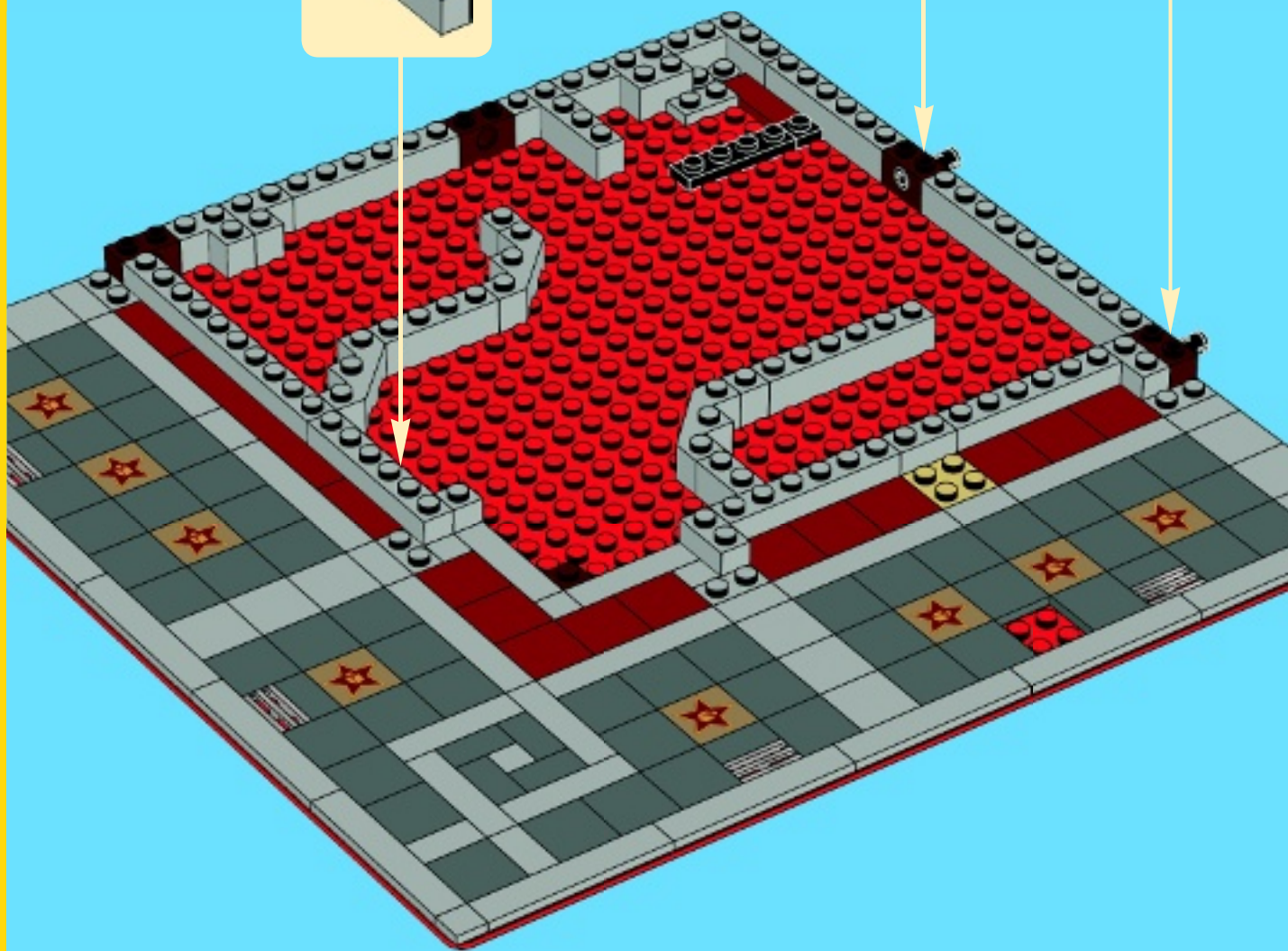
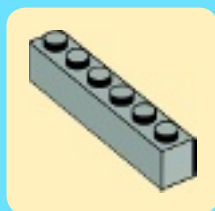



6x



2x



4x



2x



4x



4x

1

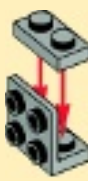

2

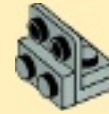

3

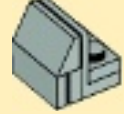

2x

9

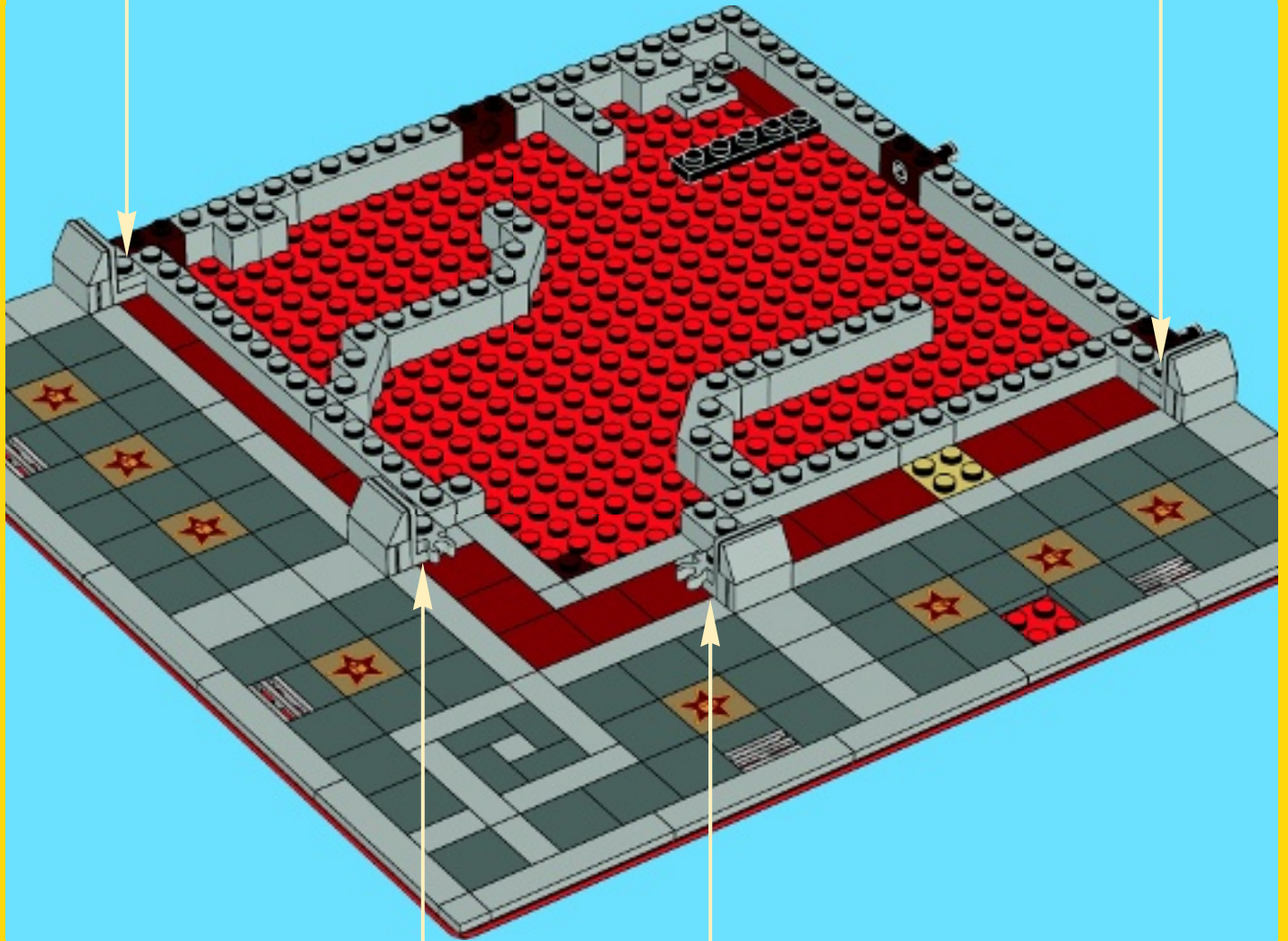

1

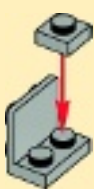

2

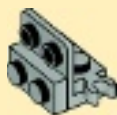

3



1

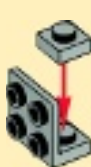

2

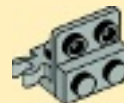

3

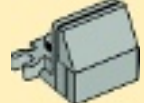

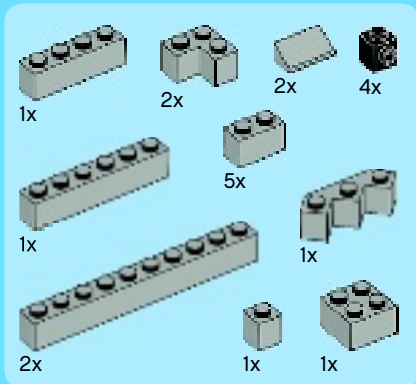

10

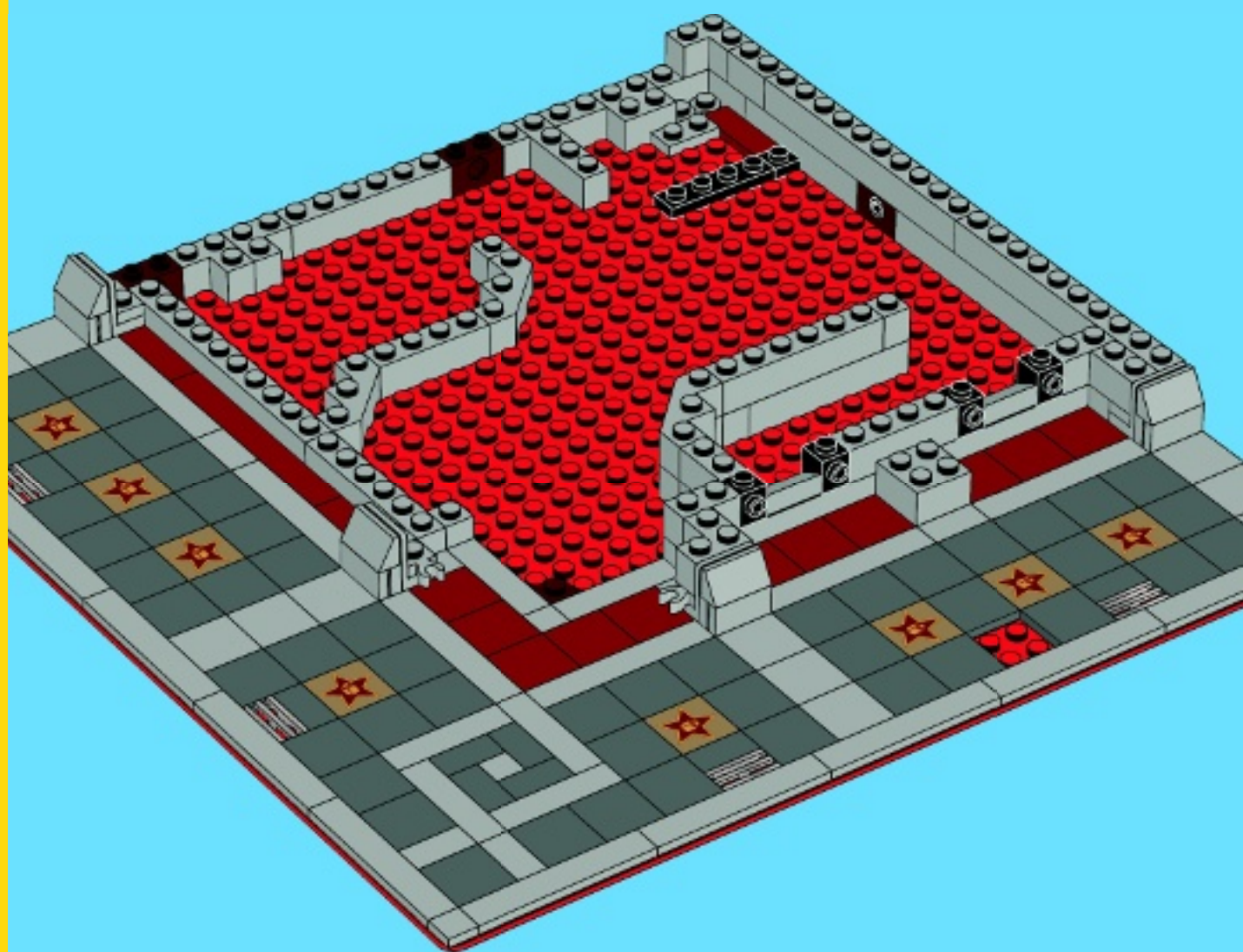

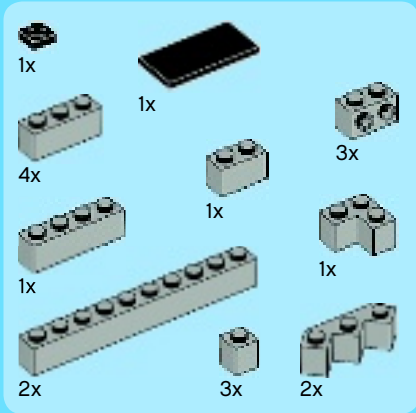

11

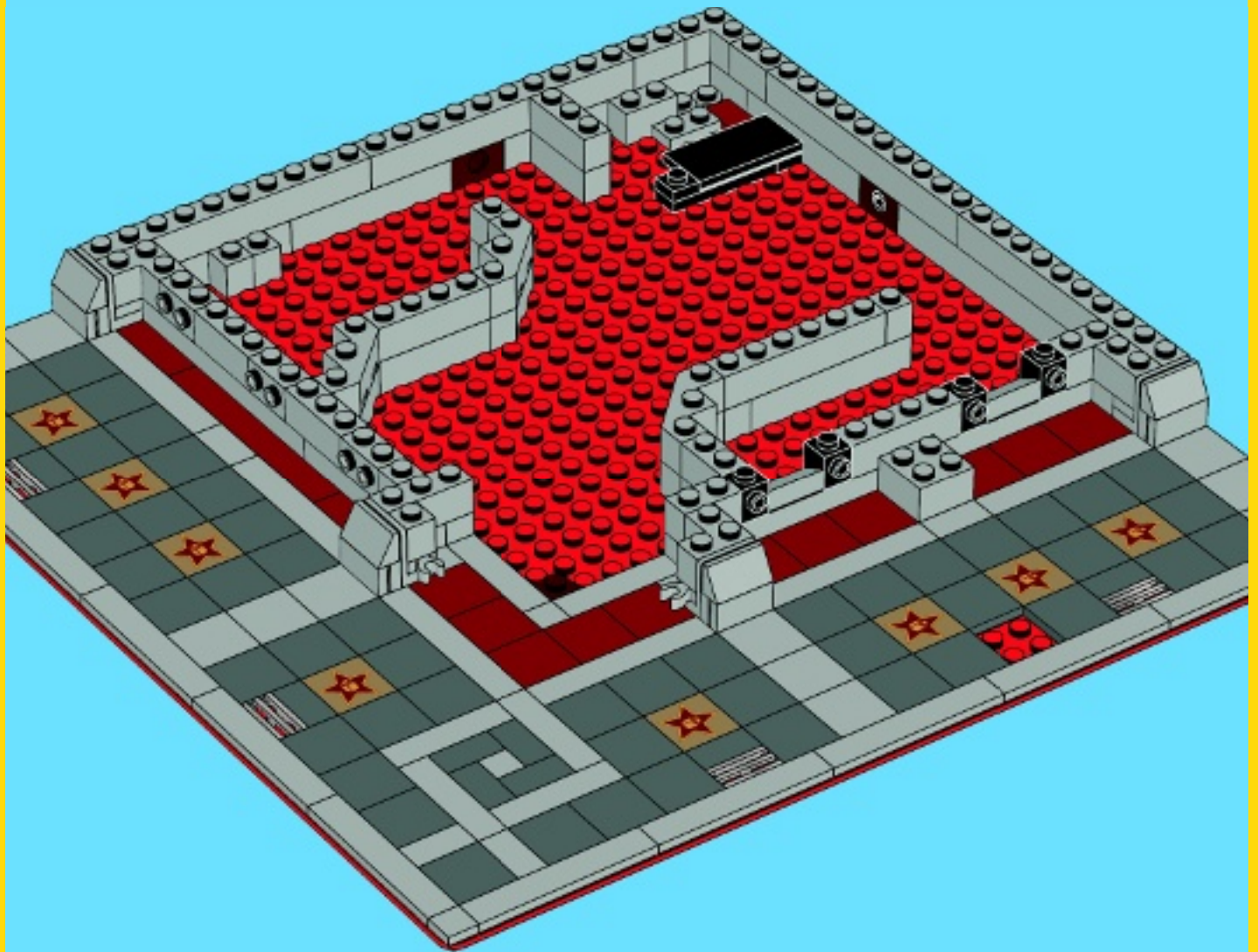

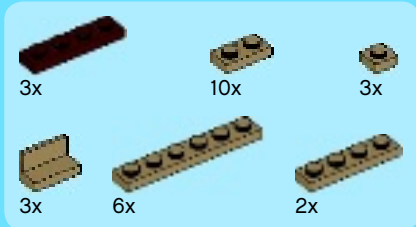

12

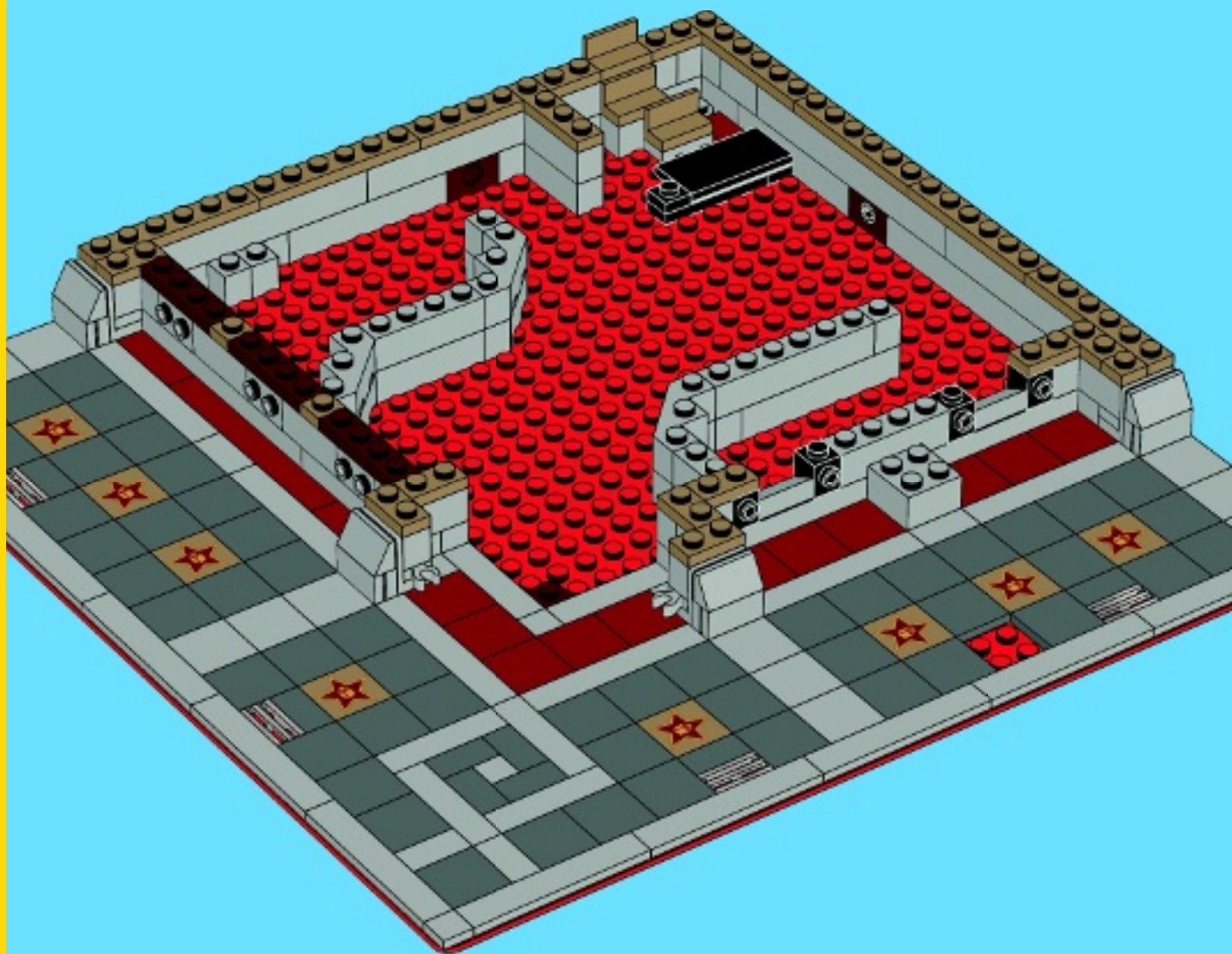

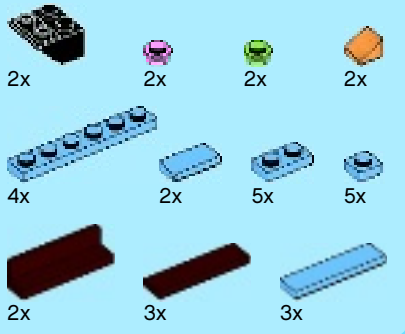

13

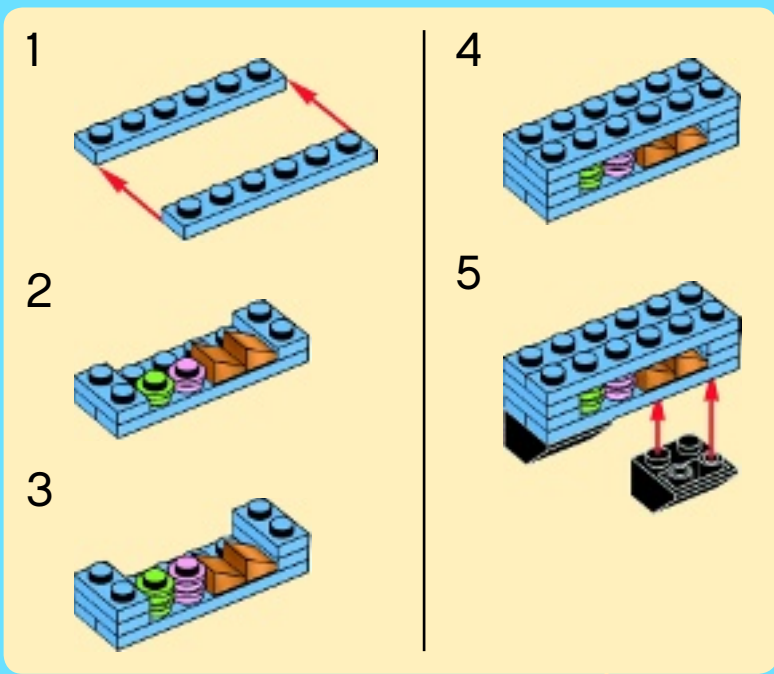

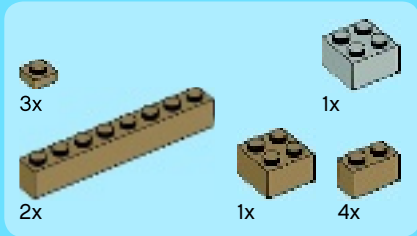

14

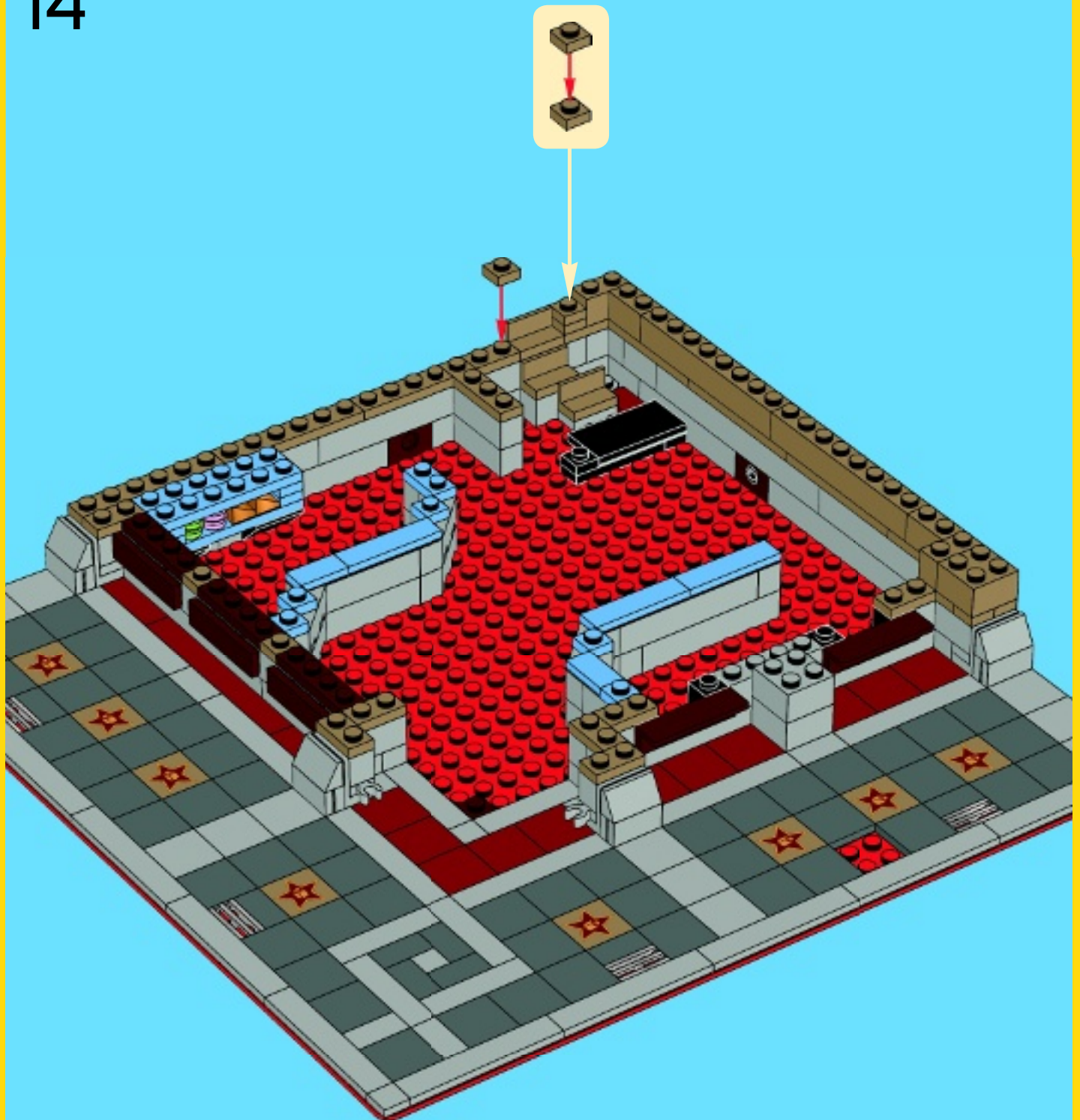

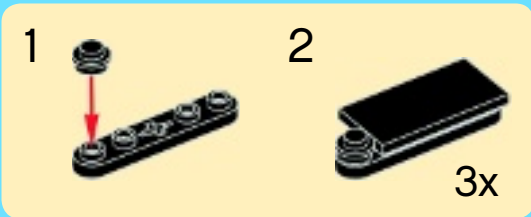
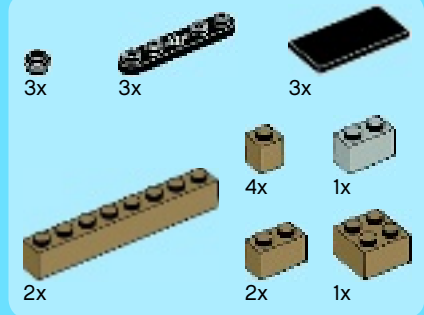

15

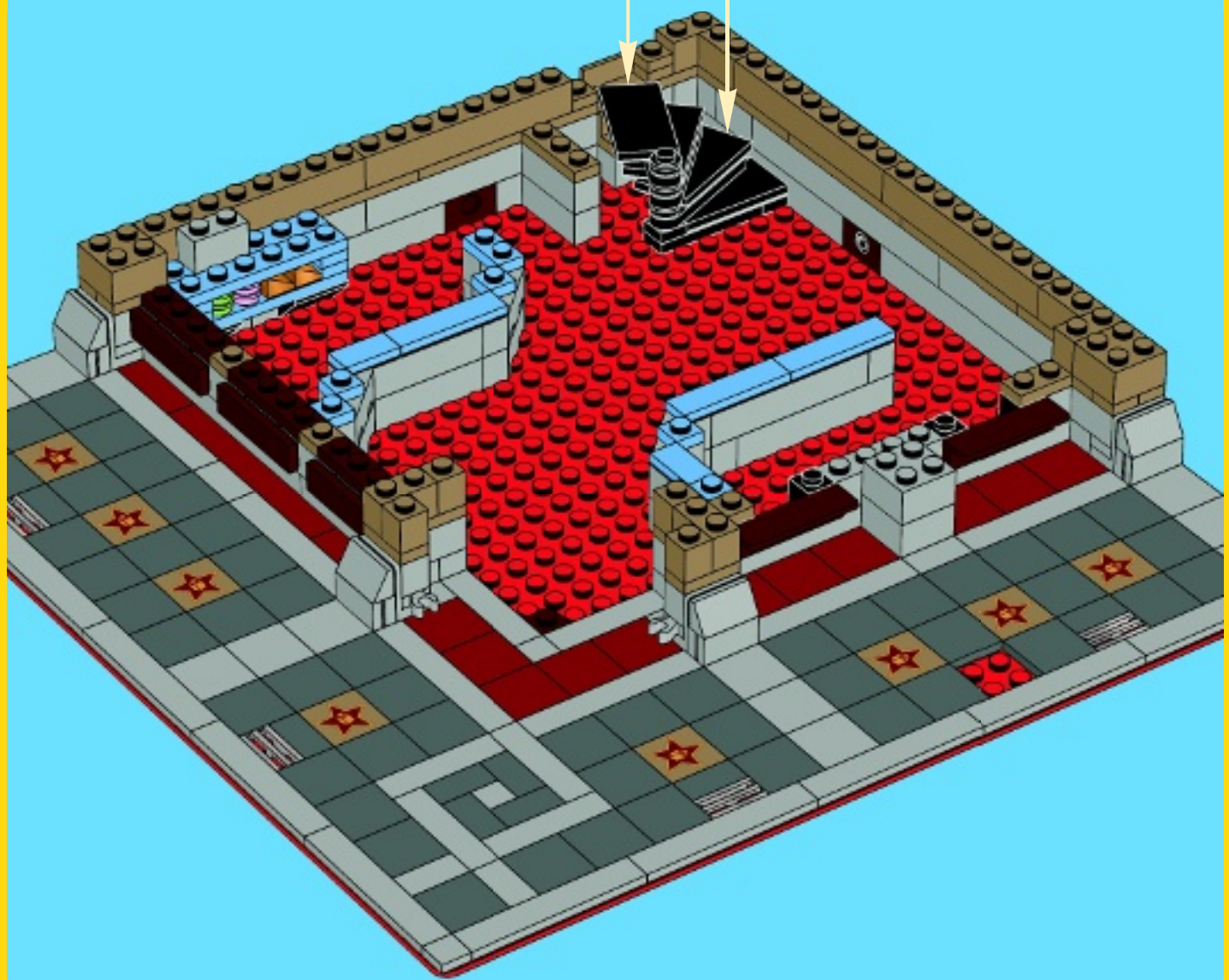



16

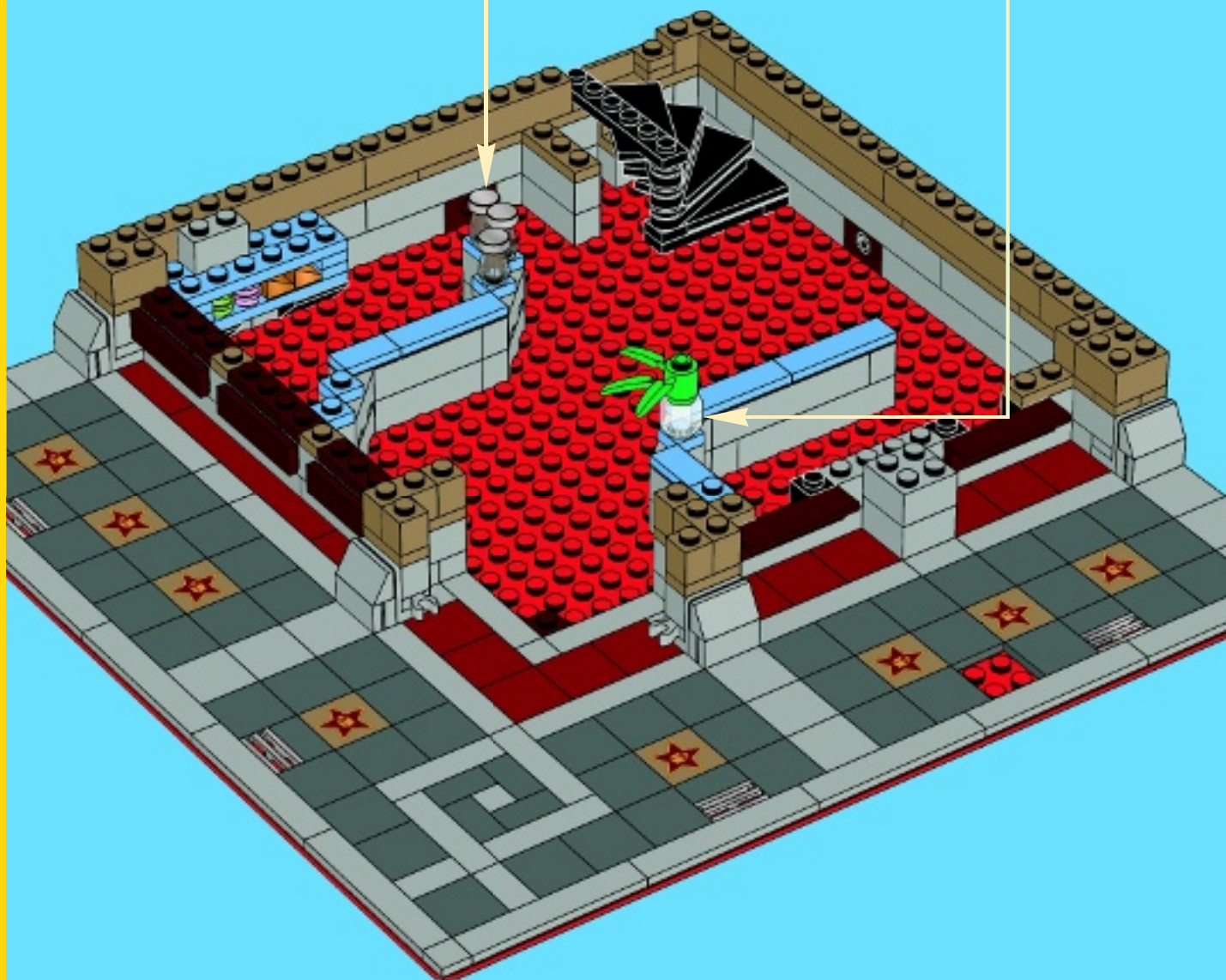



17

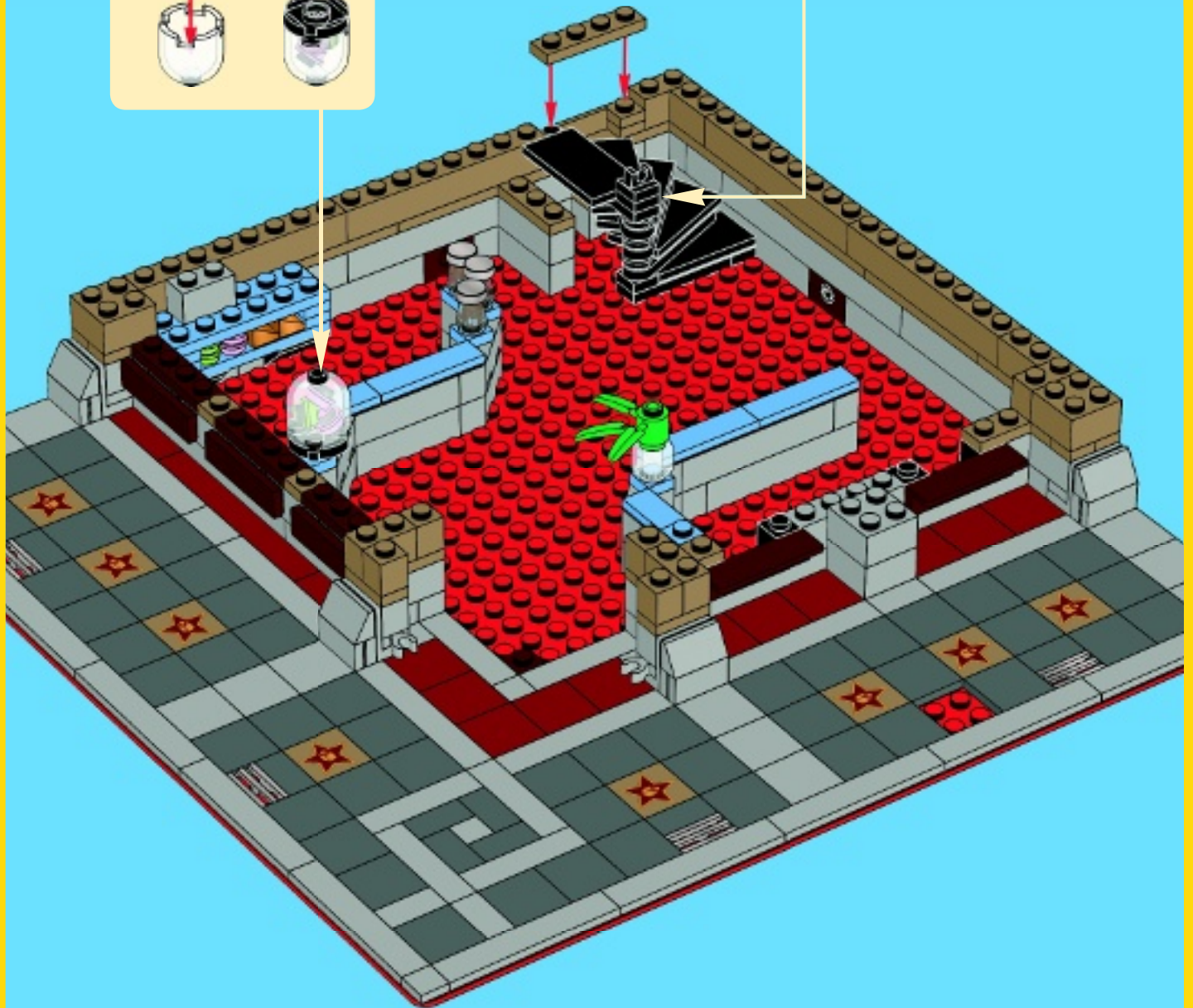

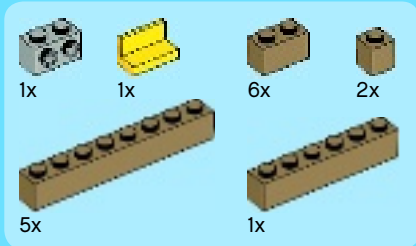

18

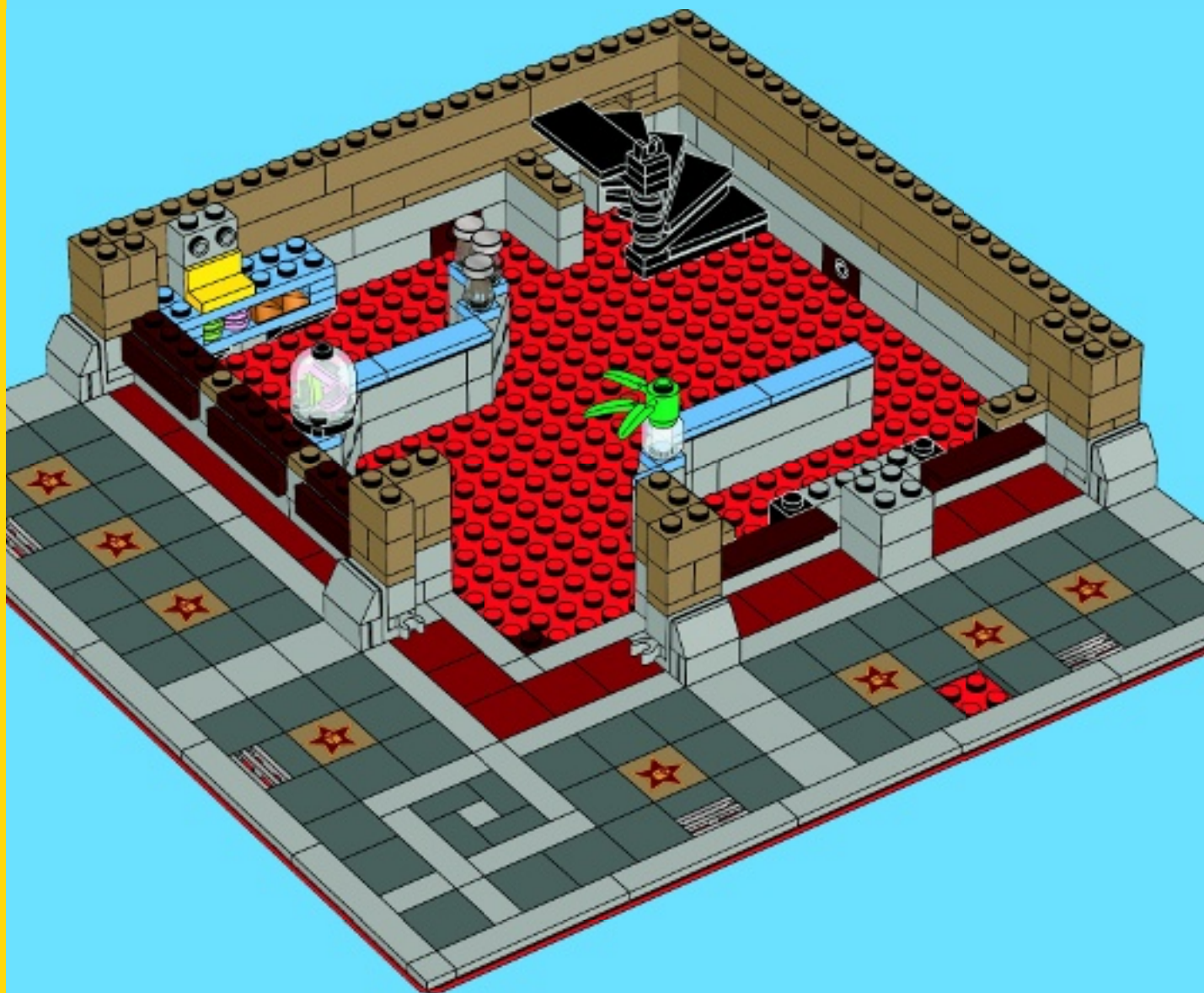

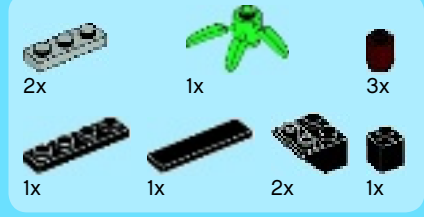

19

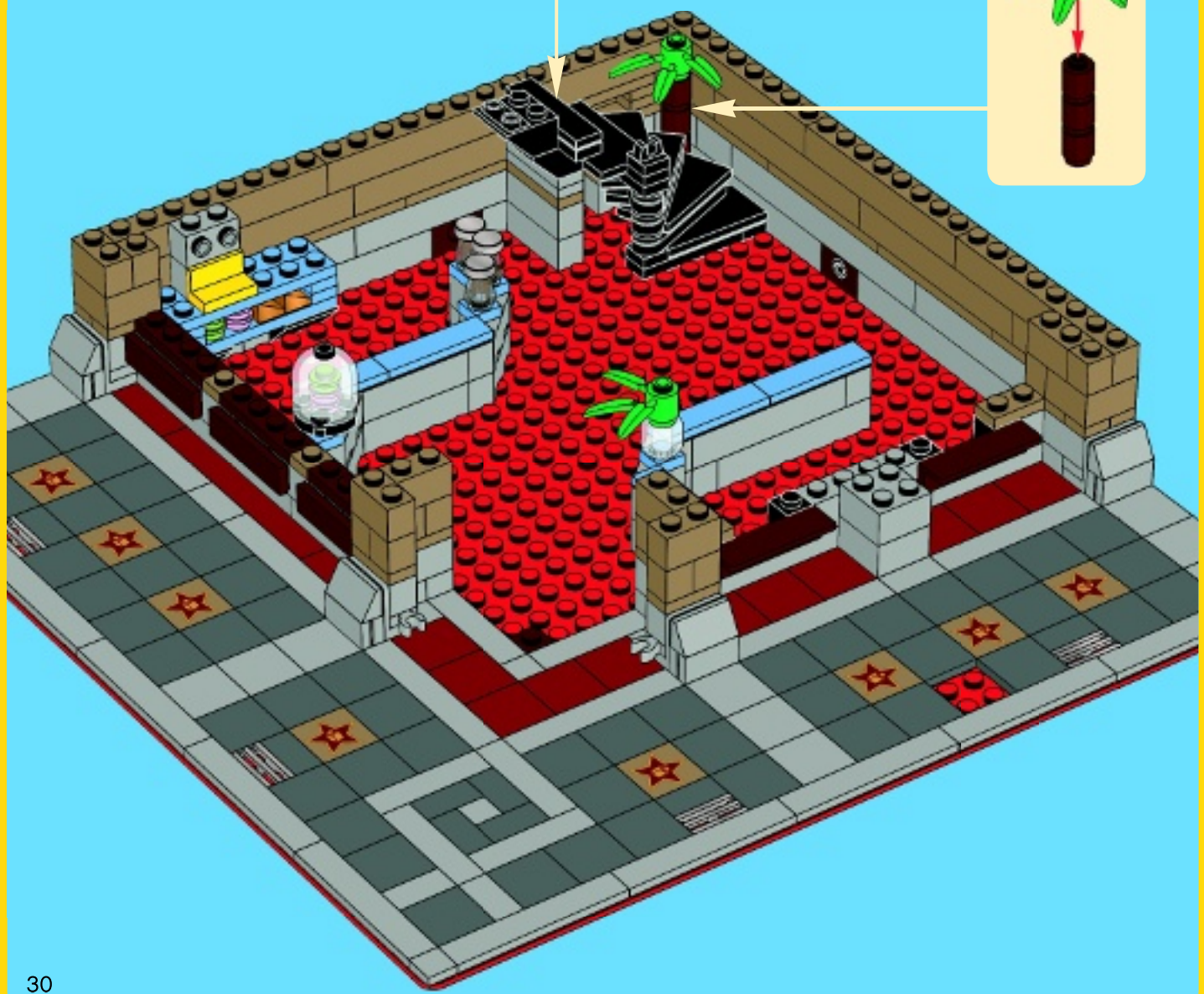
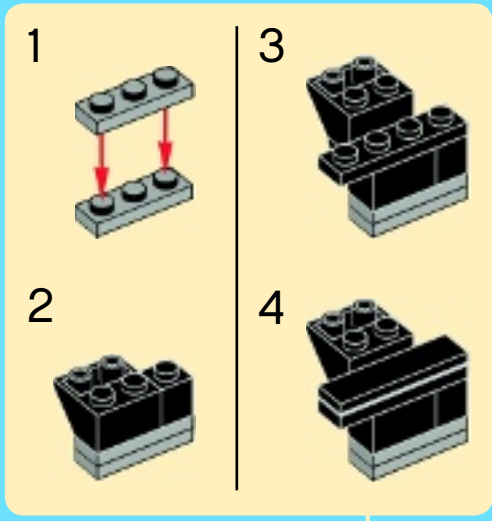

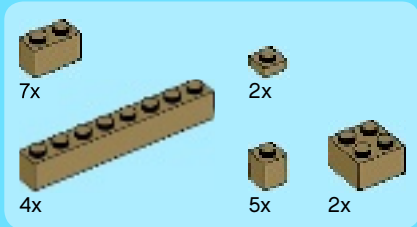

20

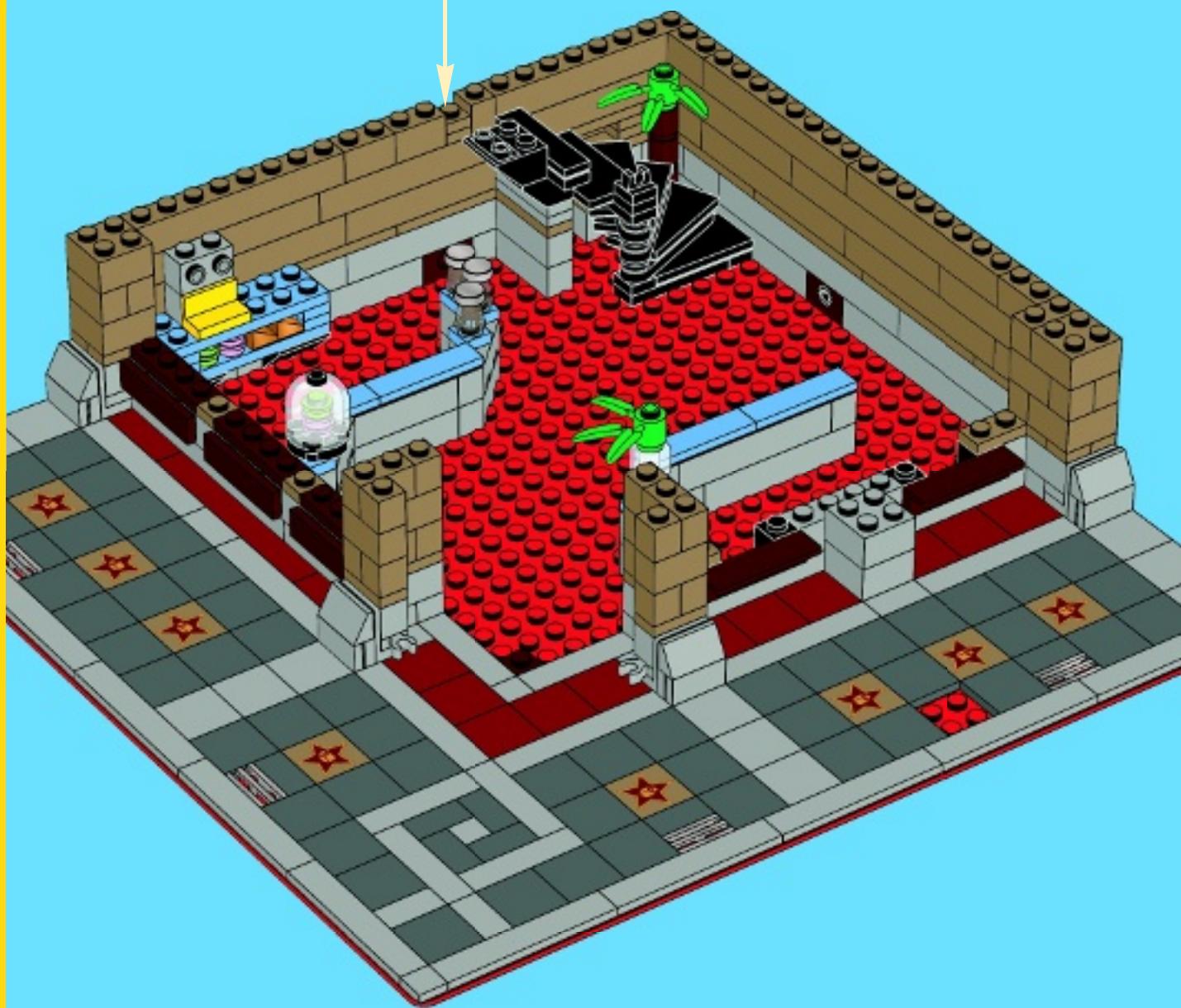

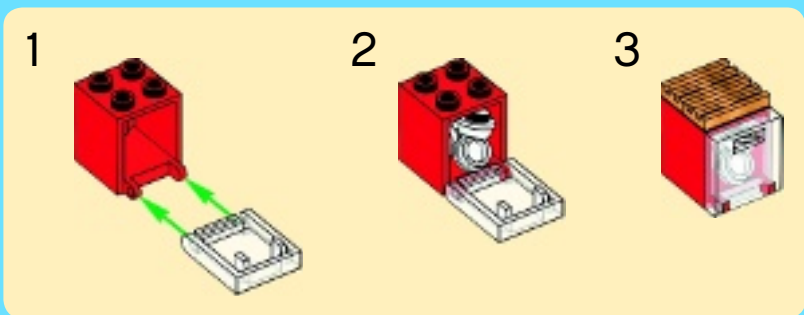
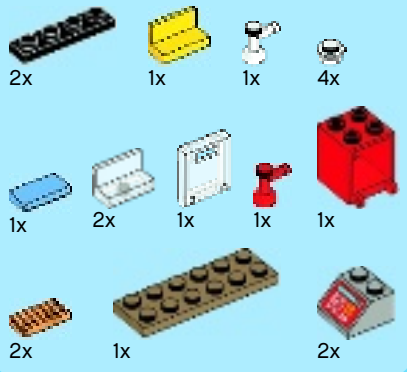

21

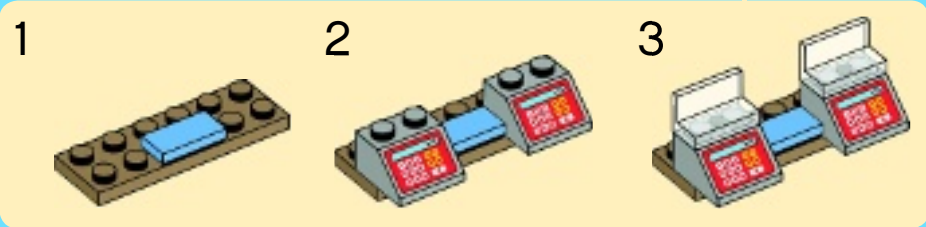
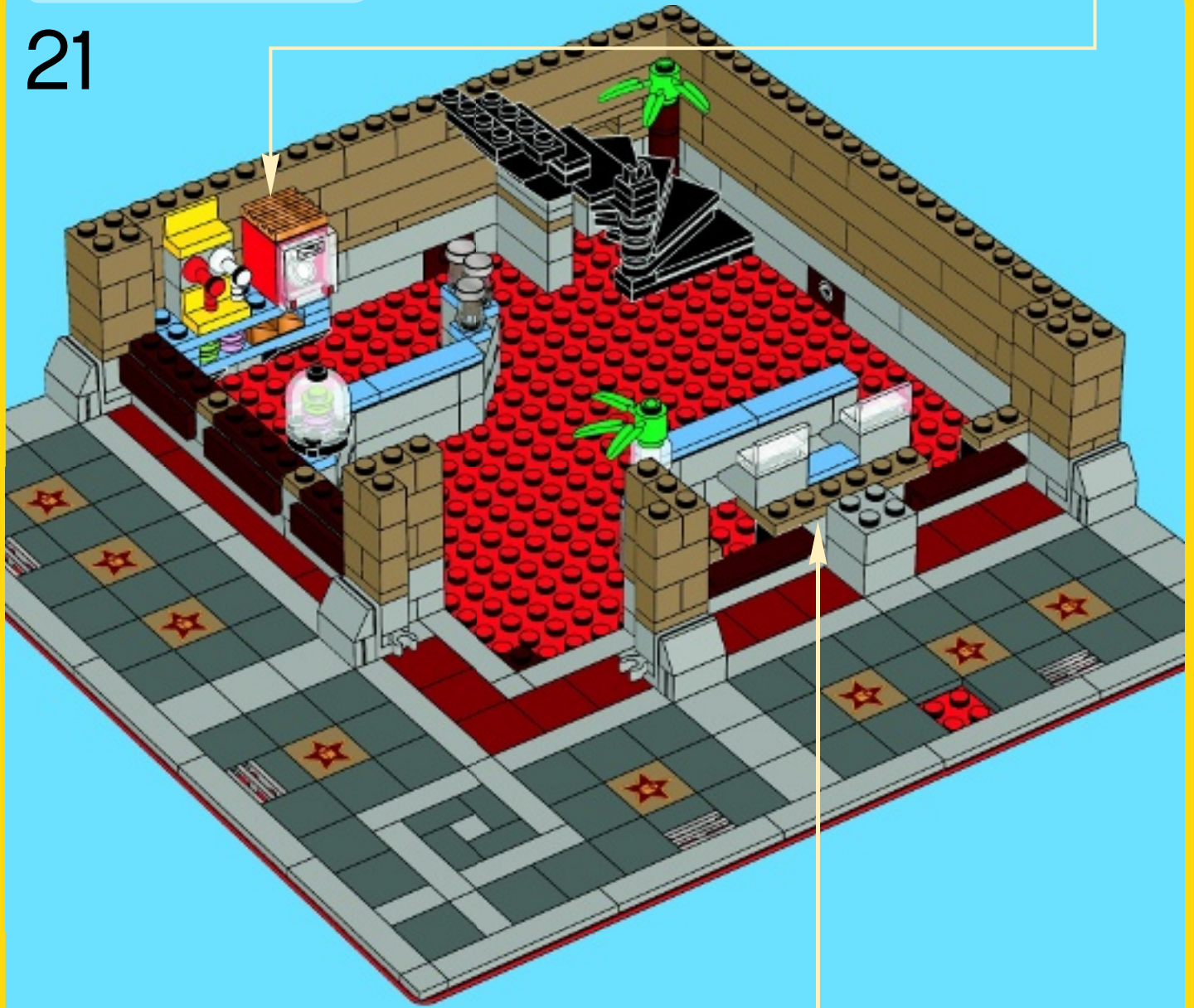

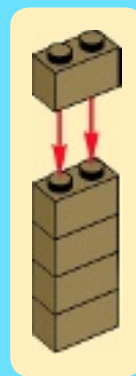
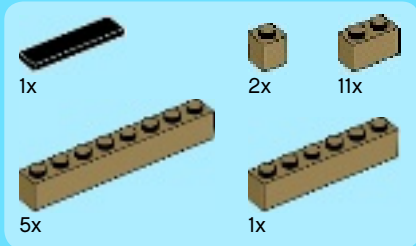

22

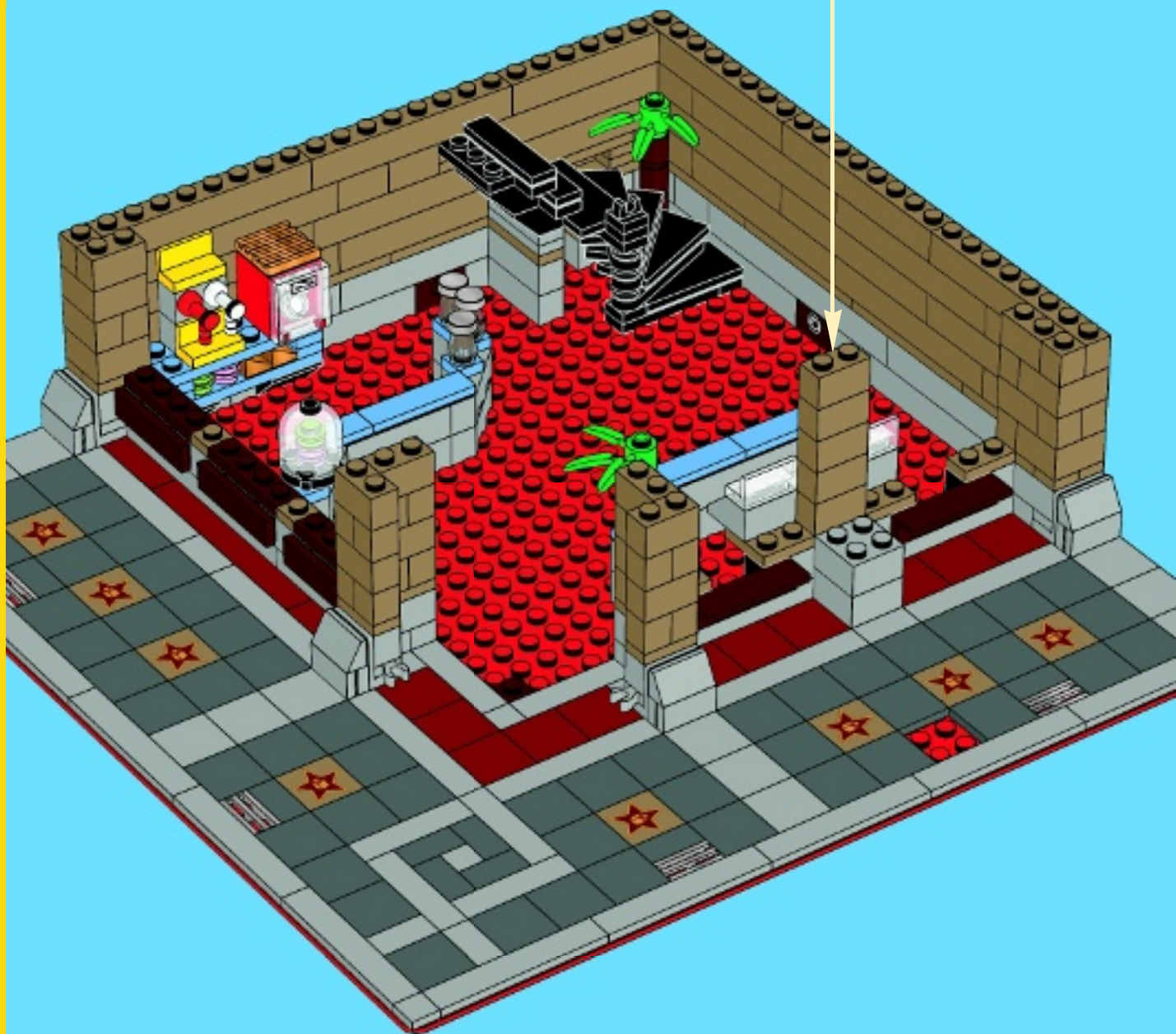

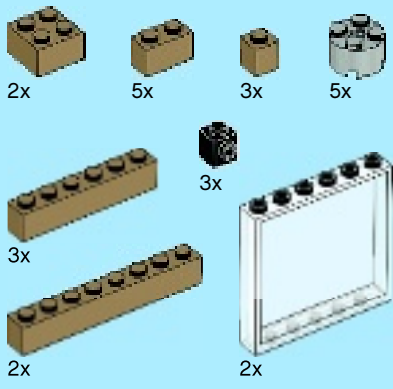

23

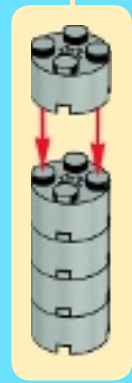

- 2x
- 2x
- 2x
- 2x
- 10x

24

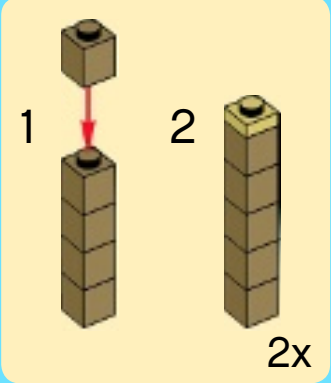

- 3x
- 2x
- 2x
- 1x
- 2x

25

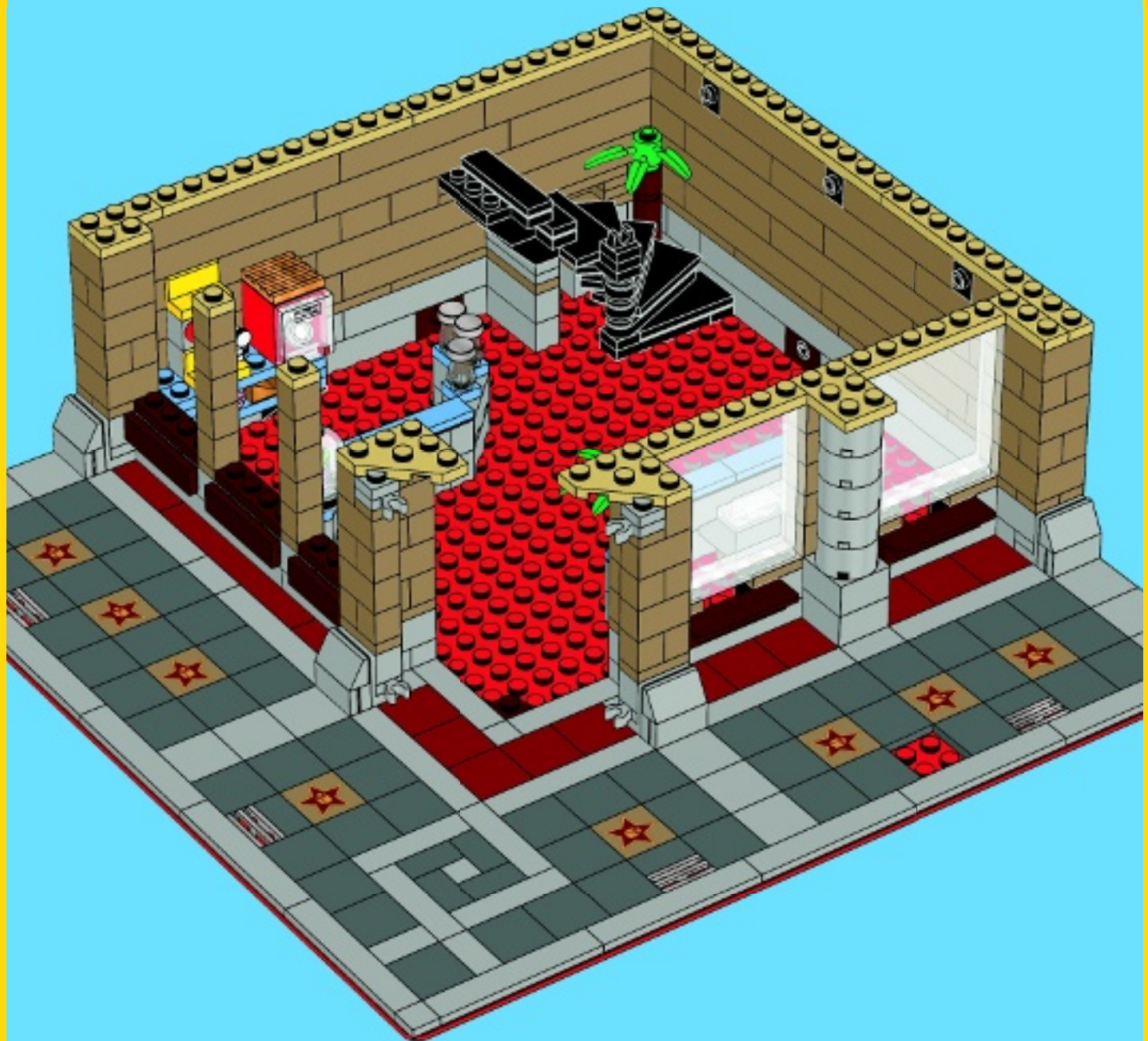

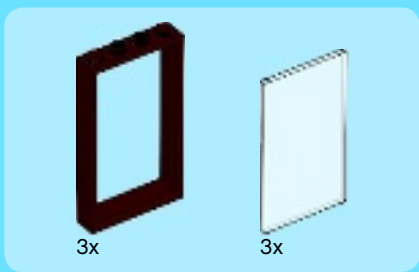

26

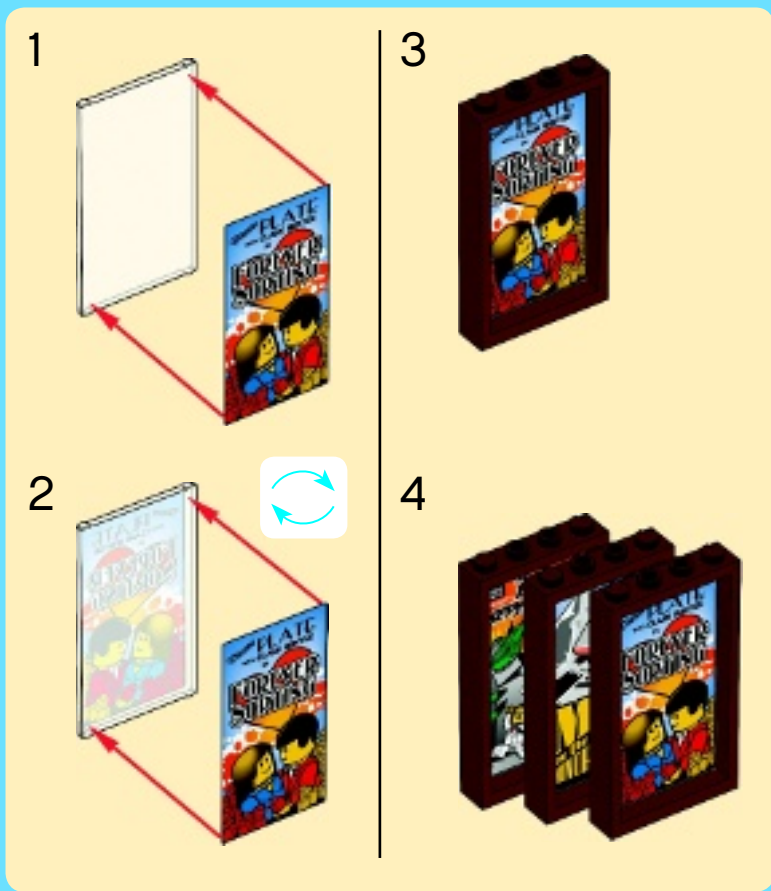

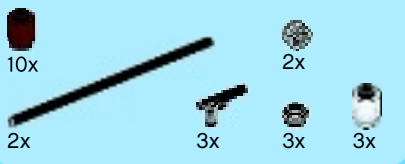

27

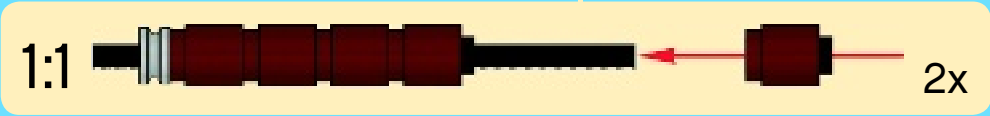
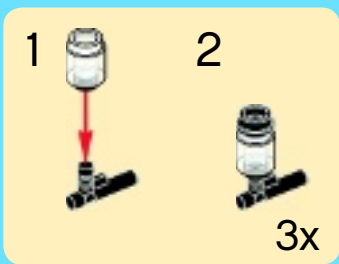

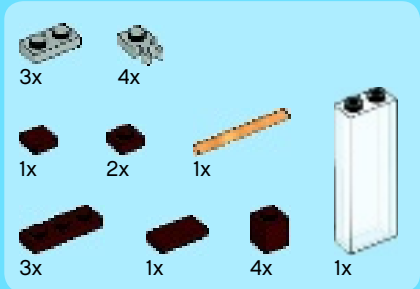

28

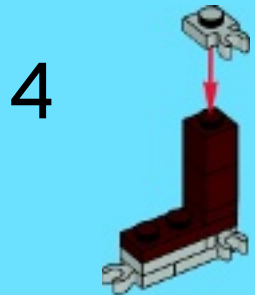
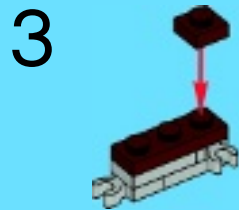
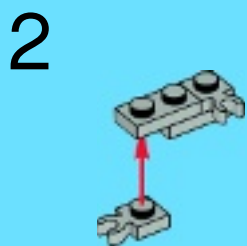
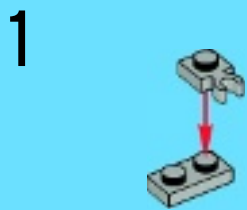

5



7



6

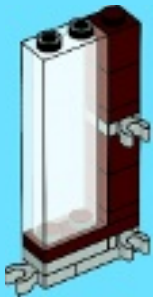

8

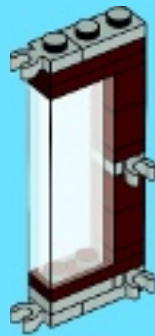

9



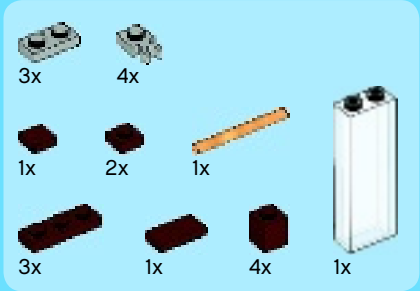

29

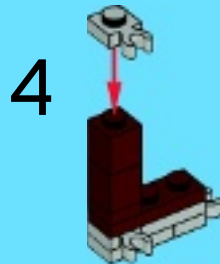
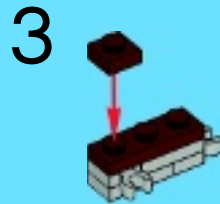
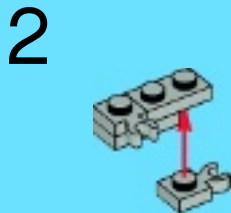
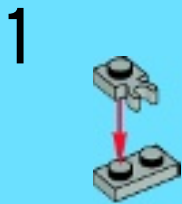

5



7



6



8

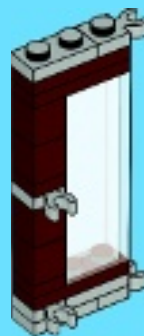

9



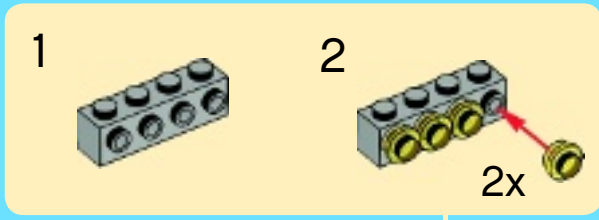
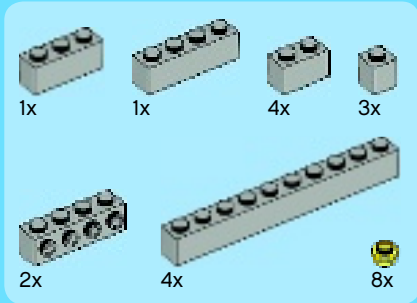

30



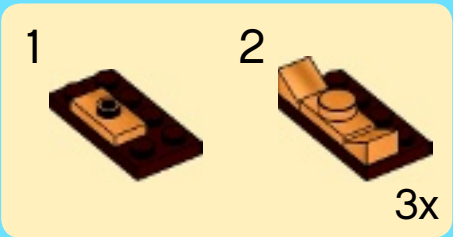
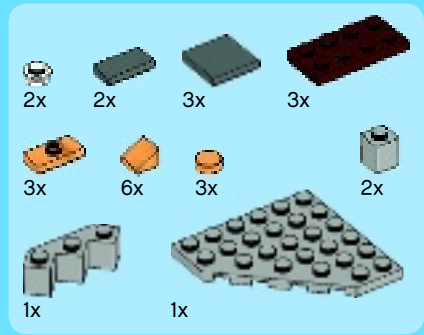

31

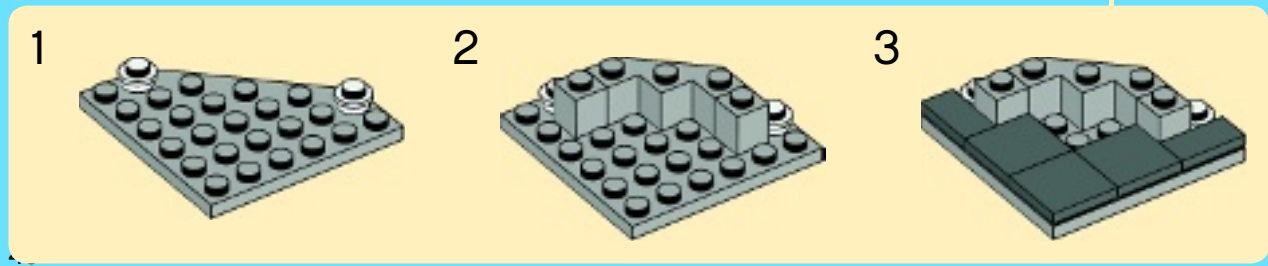

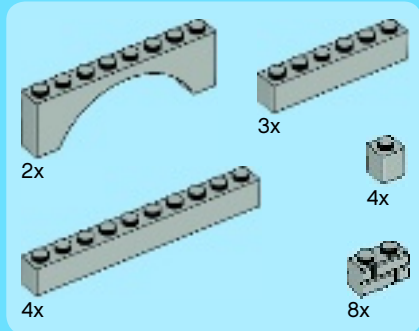

32





4x



10x

33

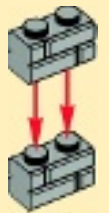

5x

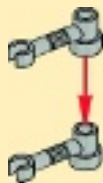
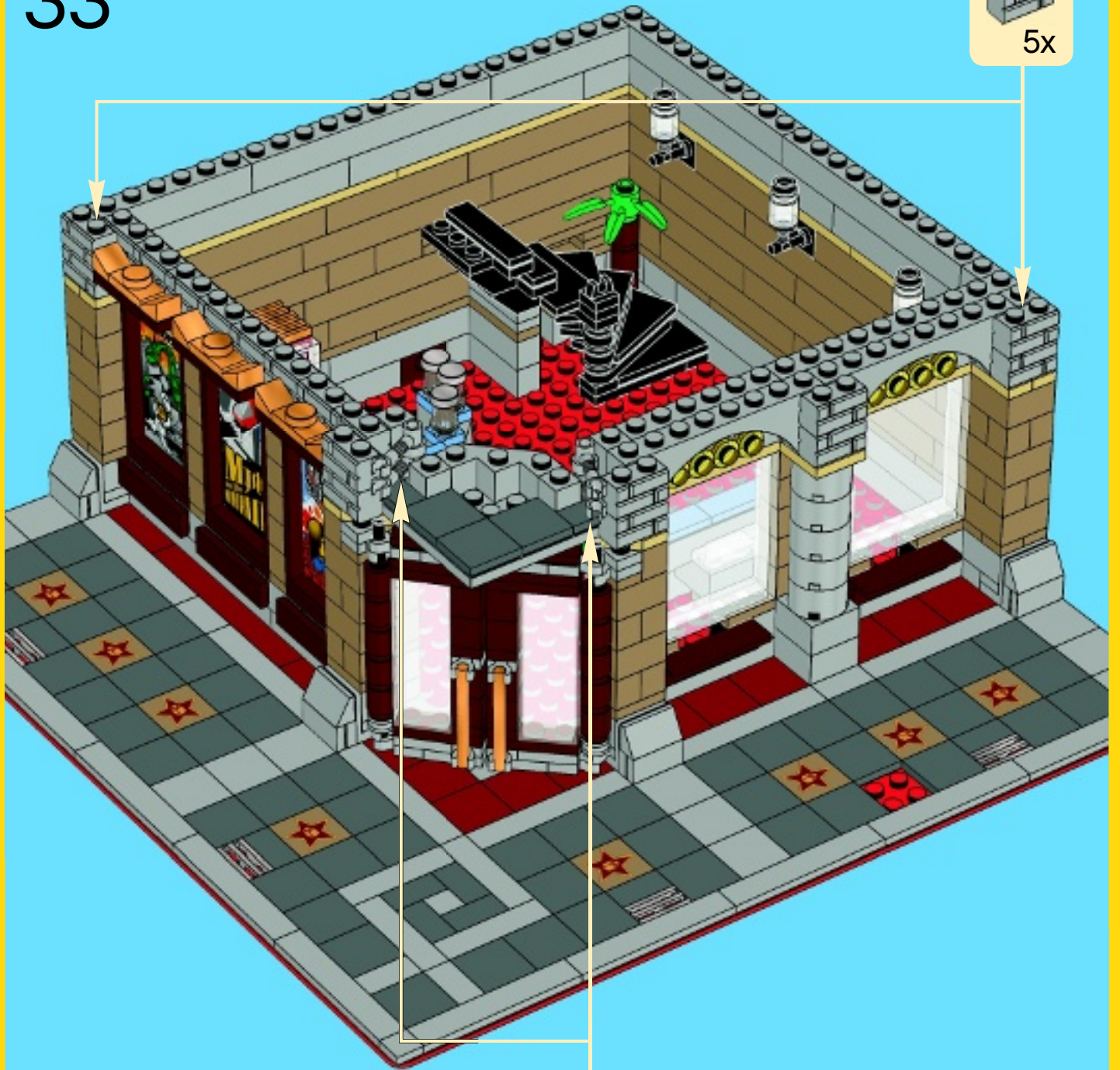

2x

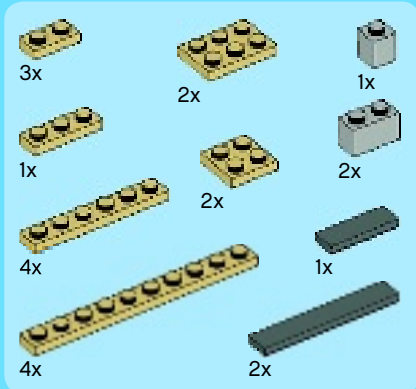

34



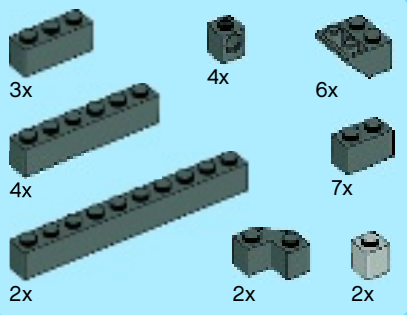

35

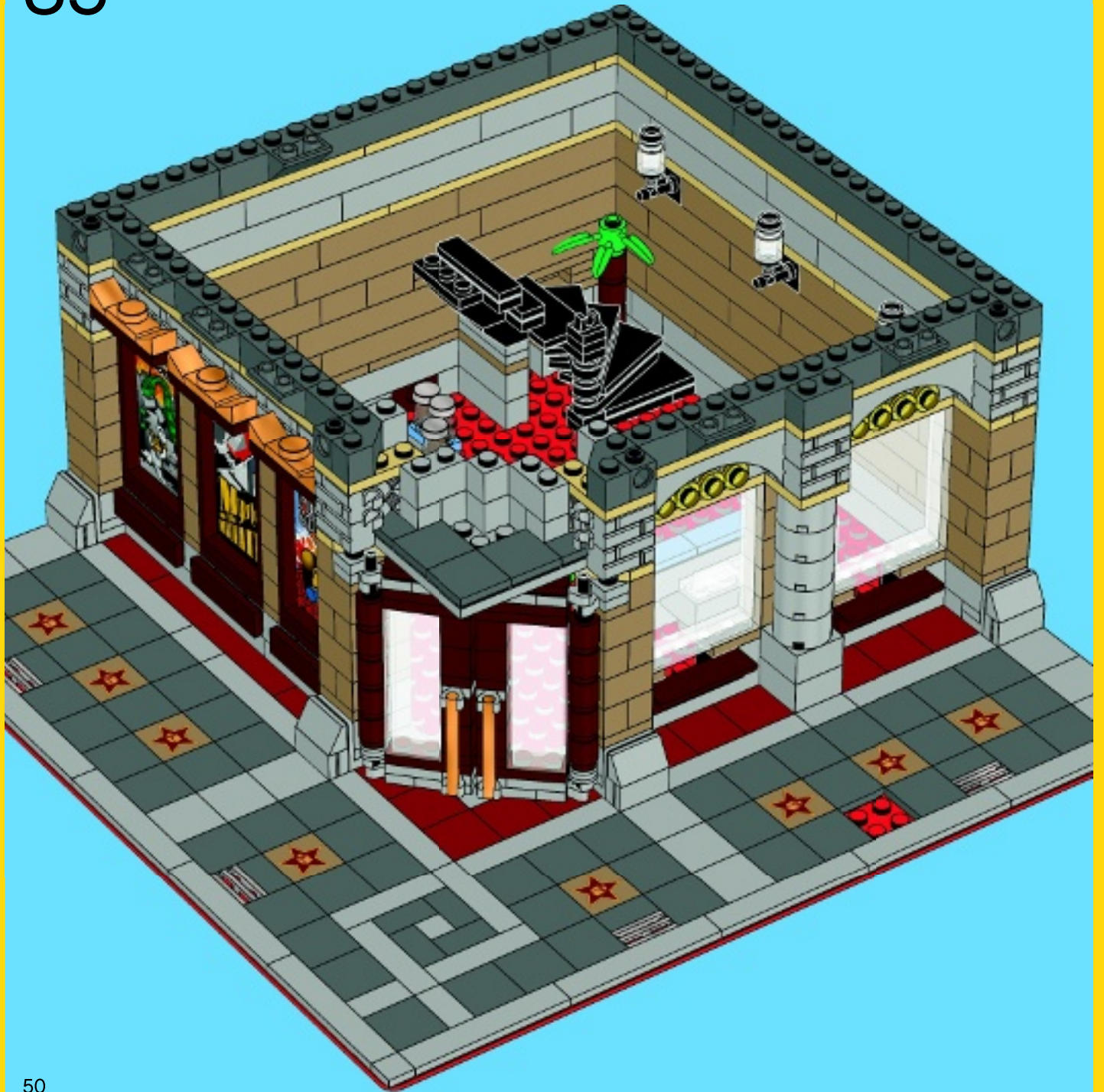

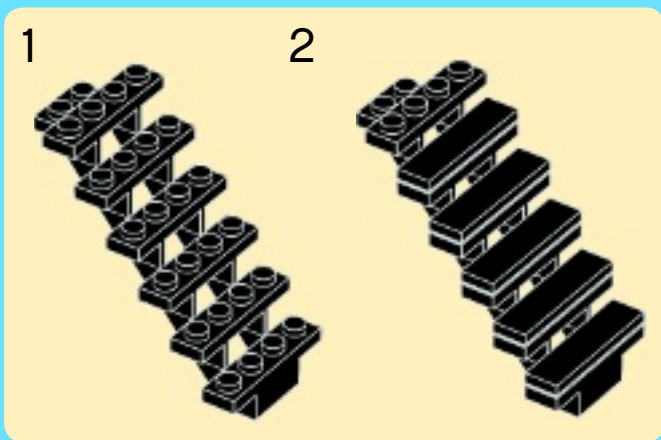
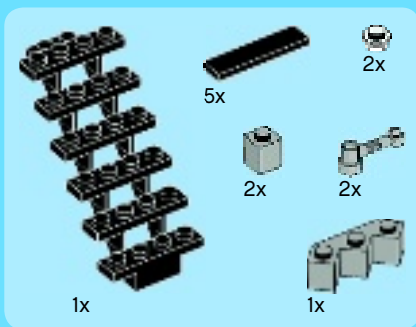

36

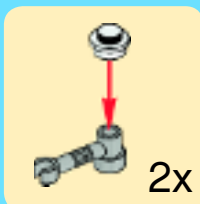

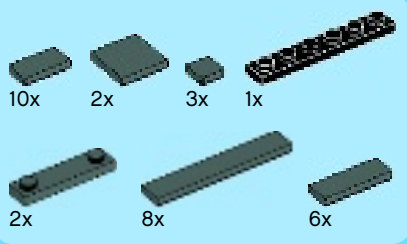

37



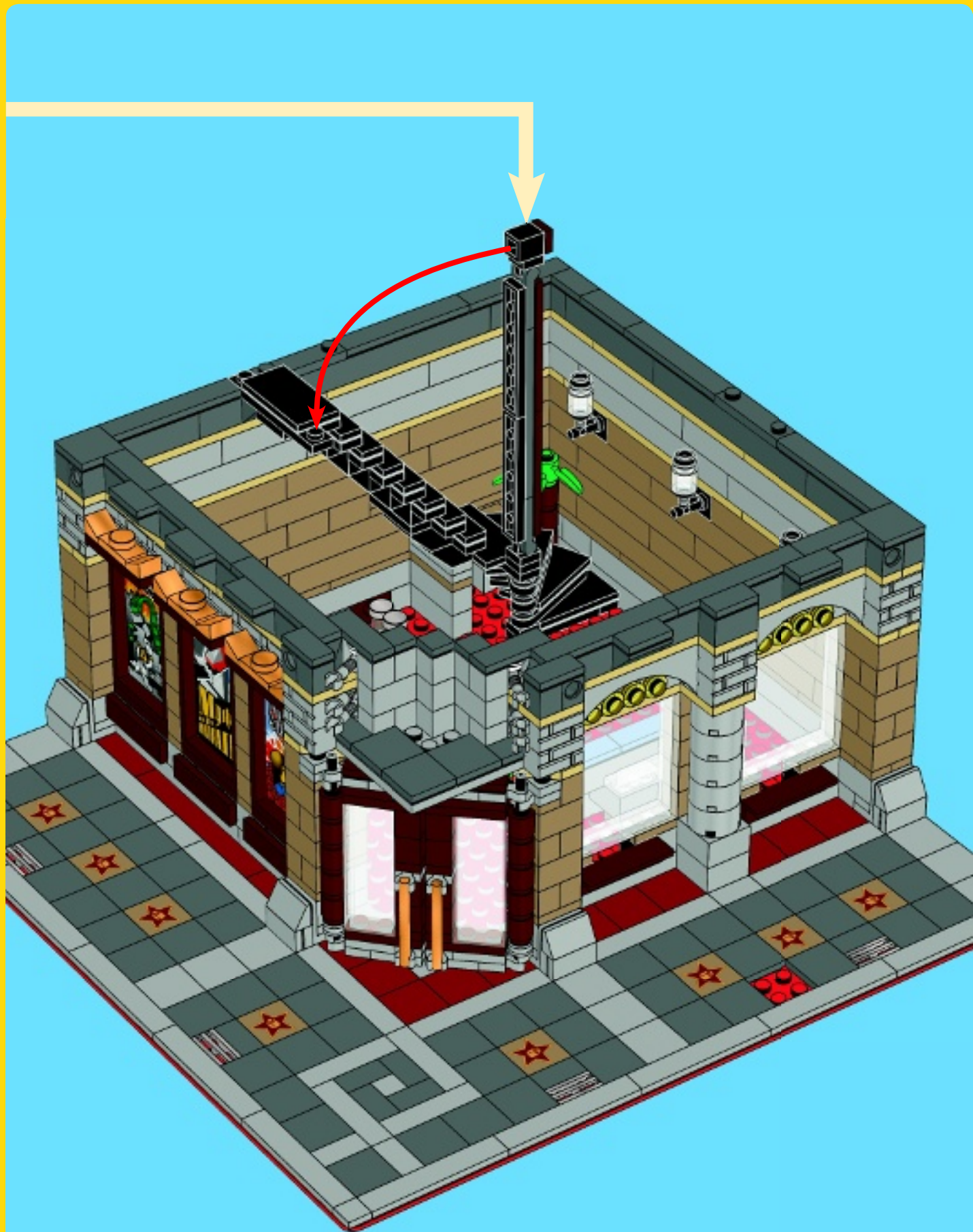

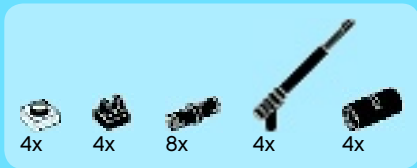

39

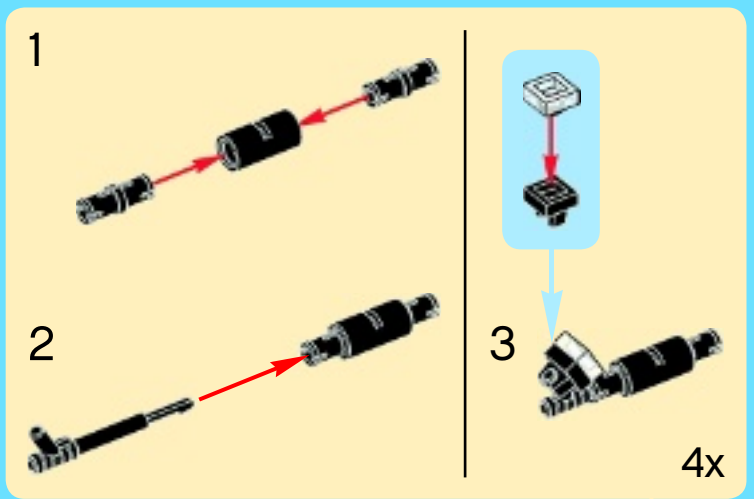

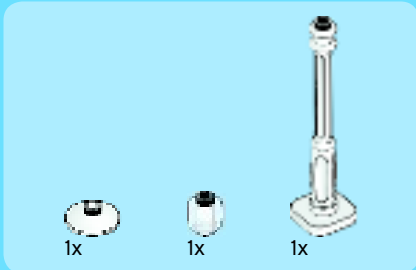

40

