

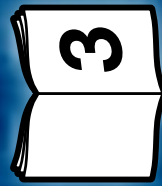

# CREATOR

10232



EXPERT





3



+

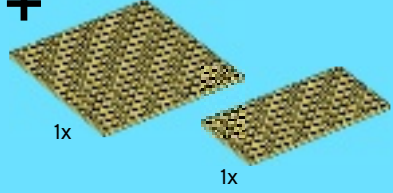

1x

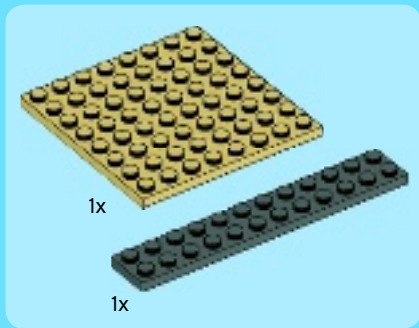
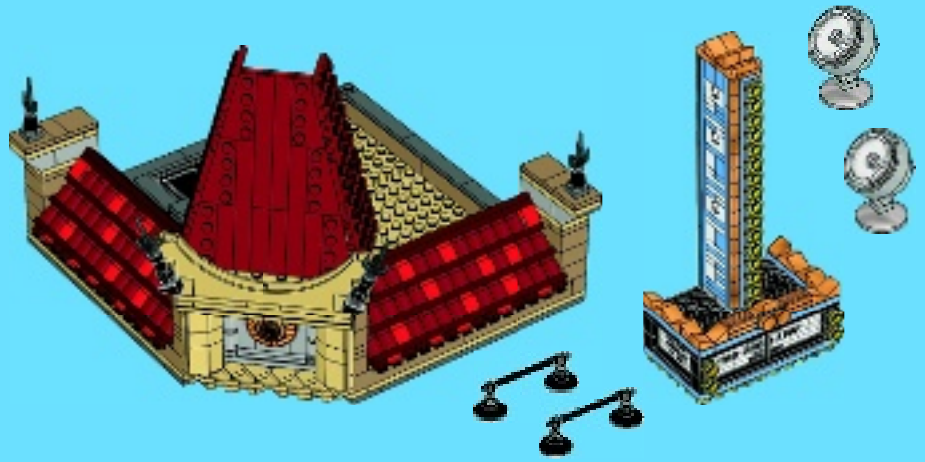

1x

1x

1

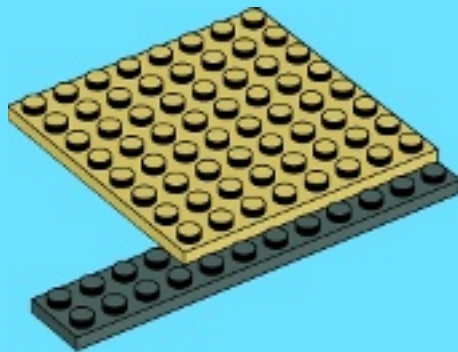

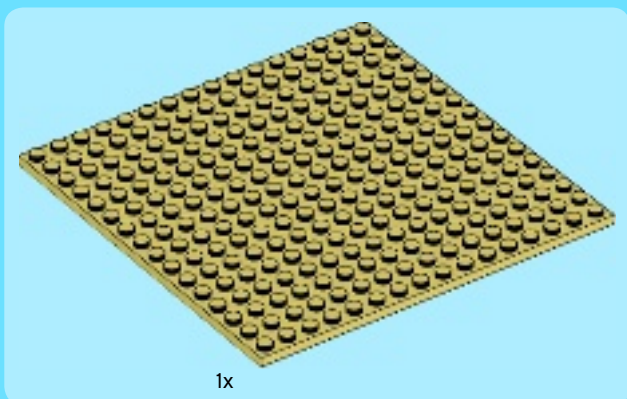

2

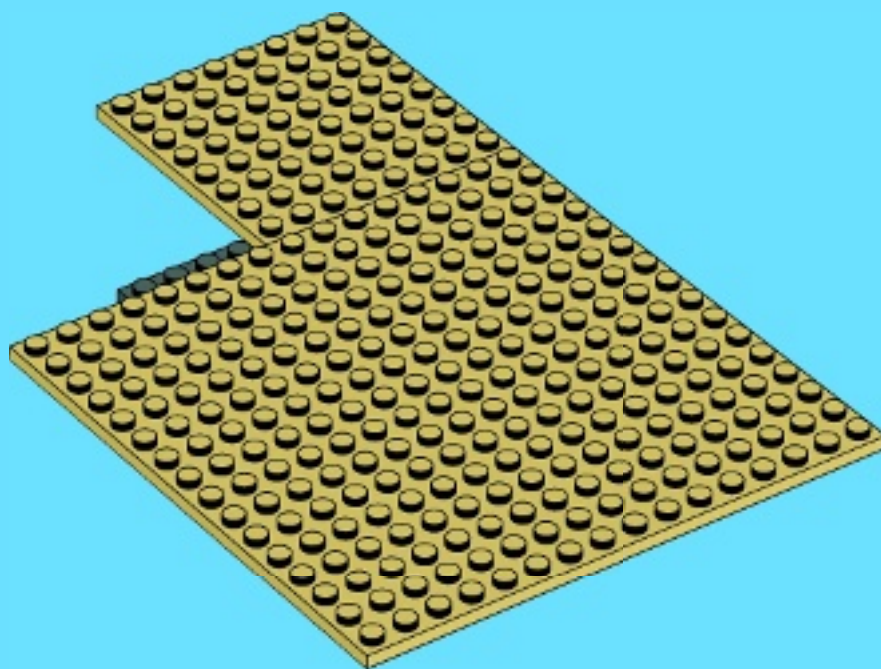

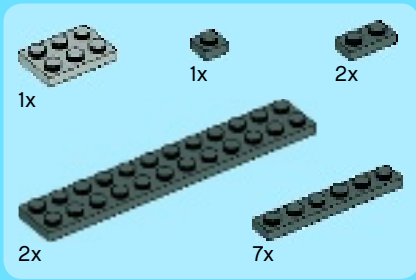

3

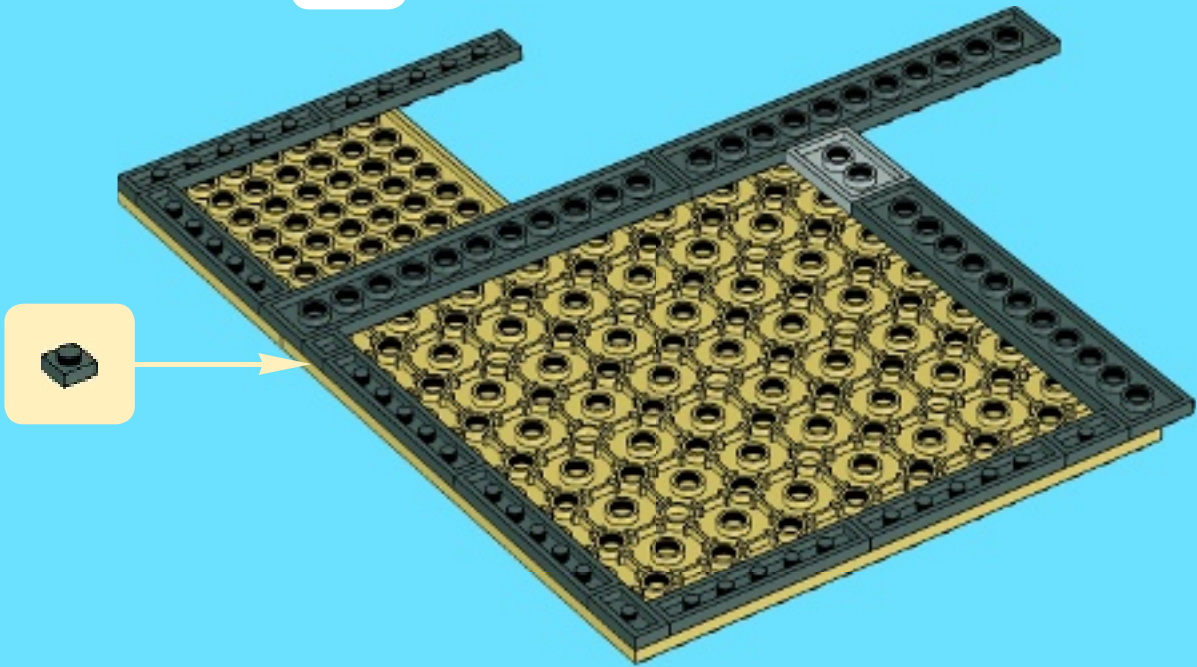

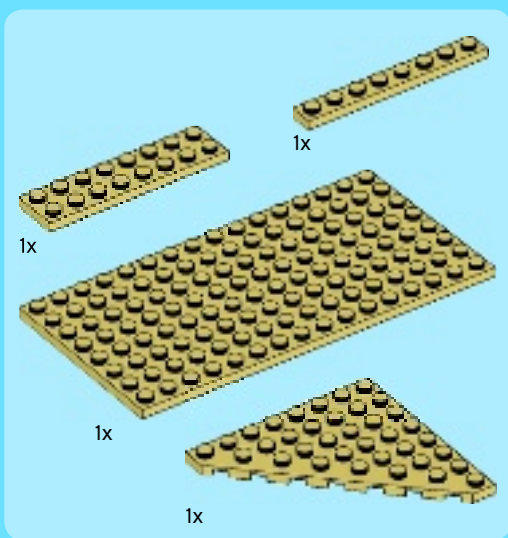

4

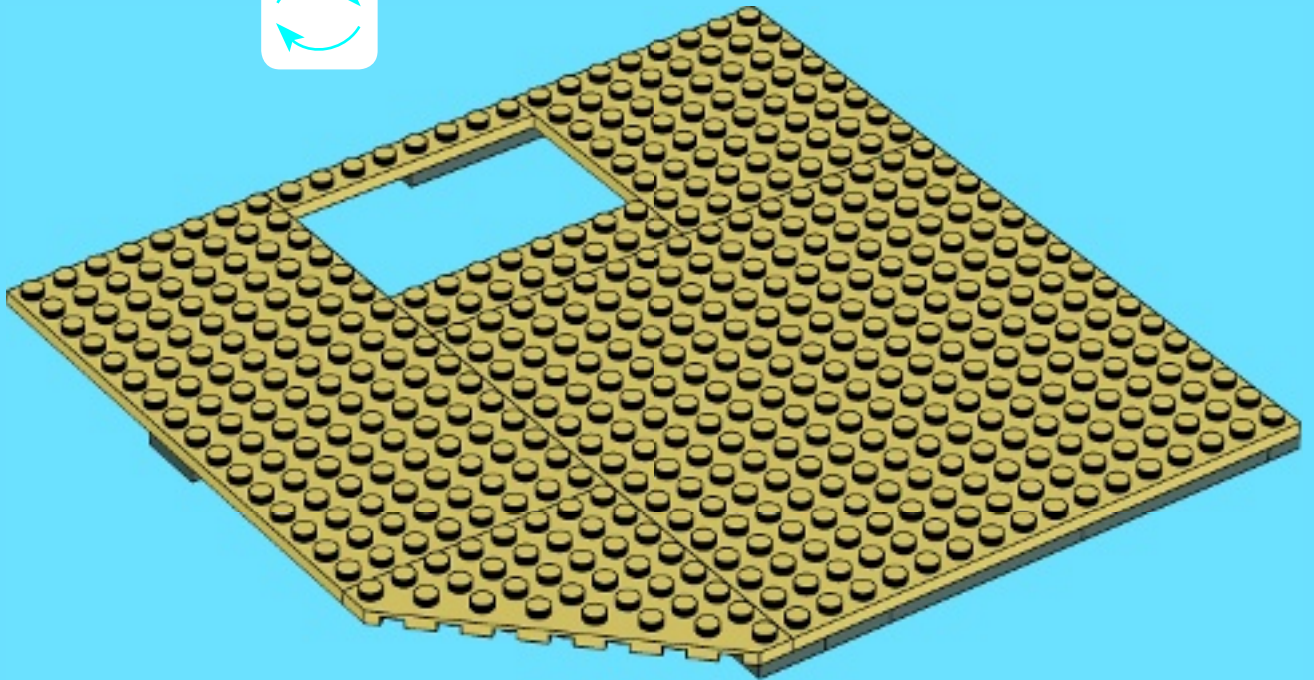



2x



1x



4x



1x

# 5

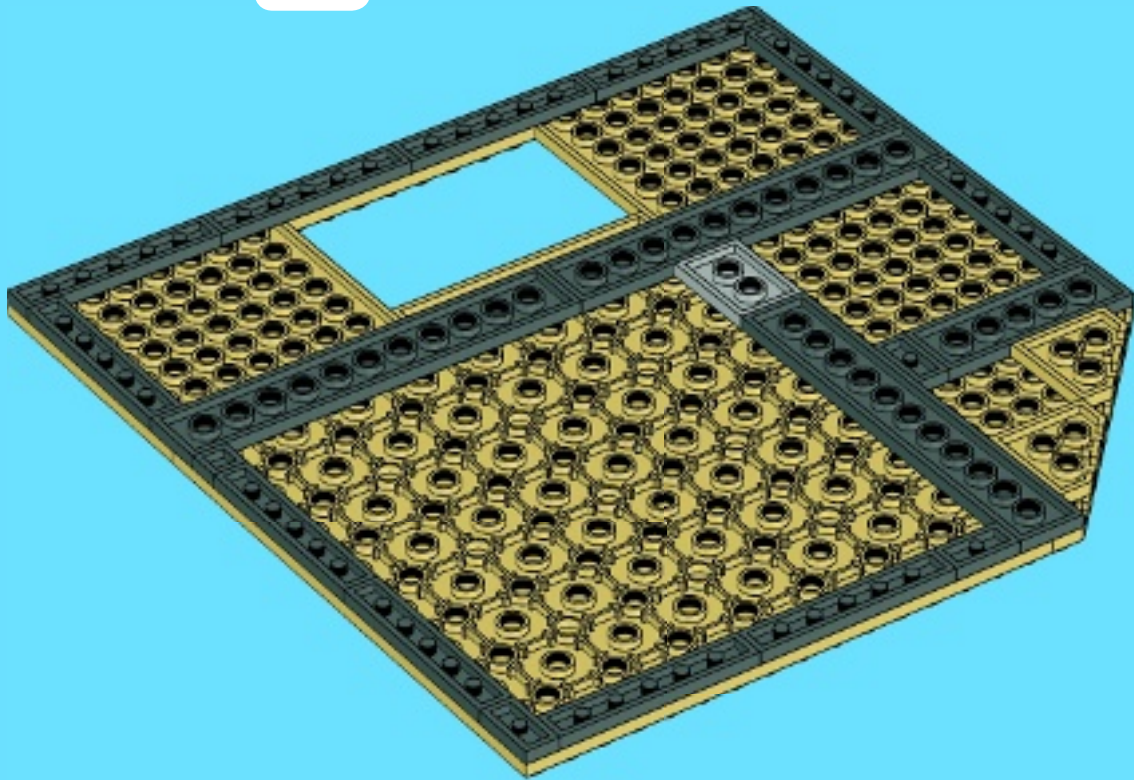

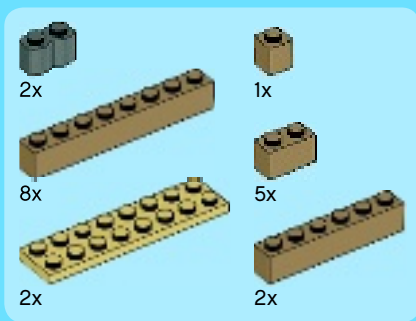

6

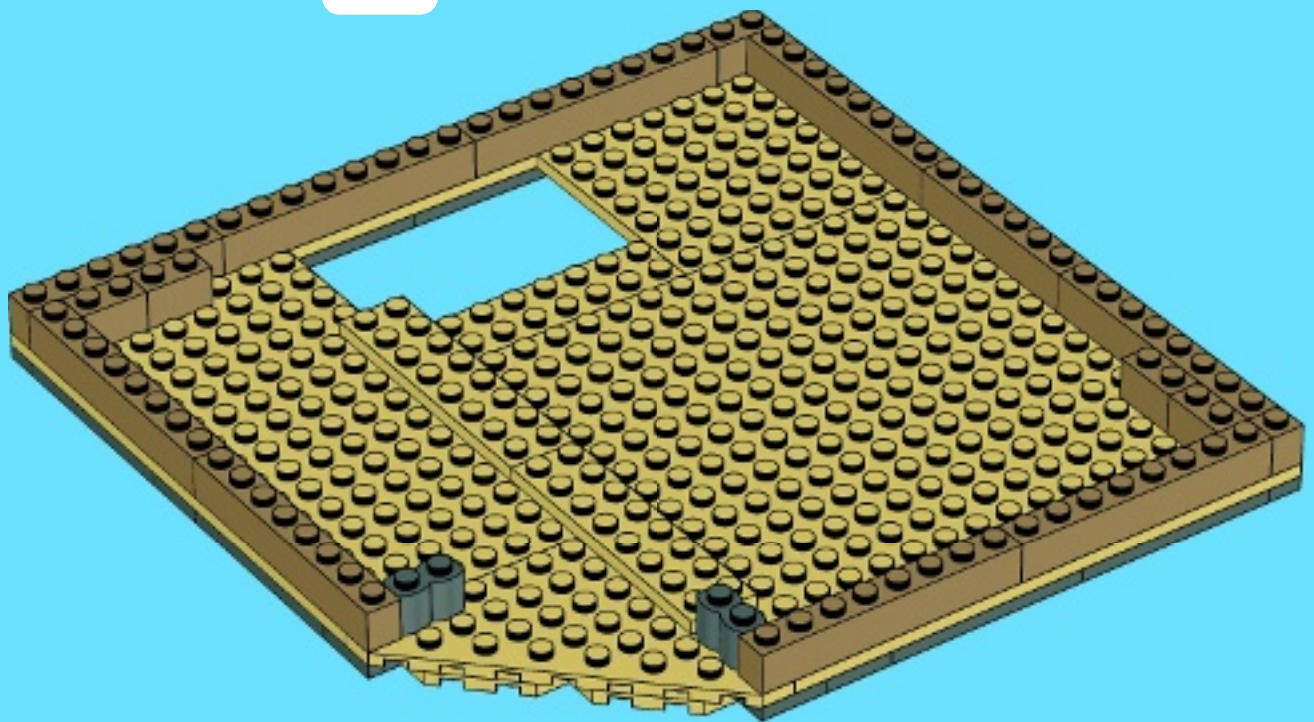

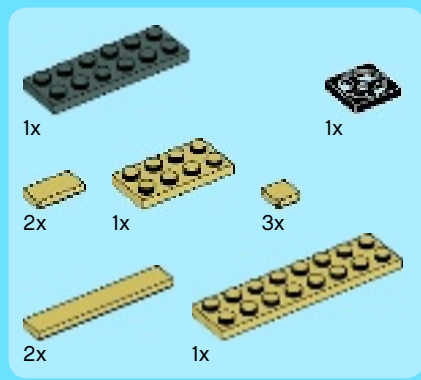

7

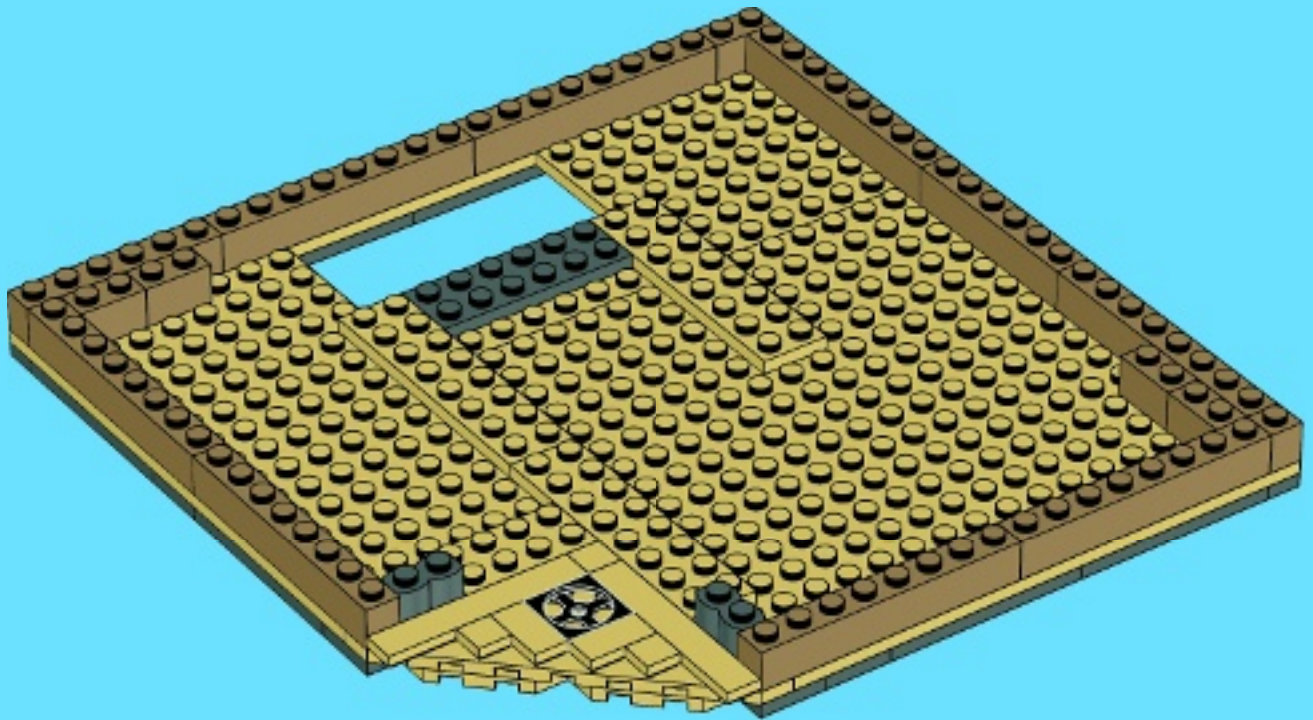



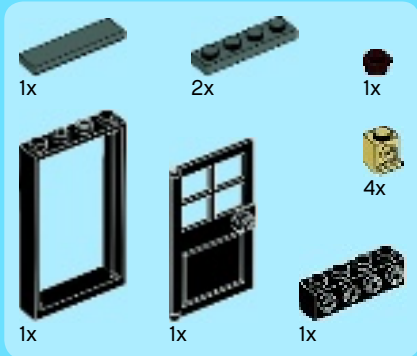

8

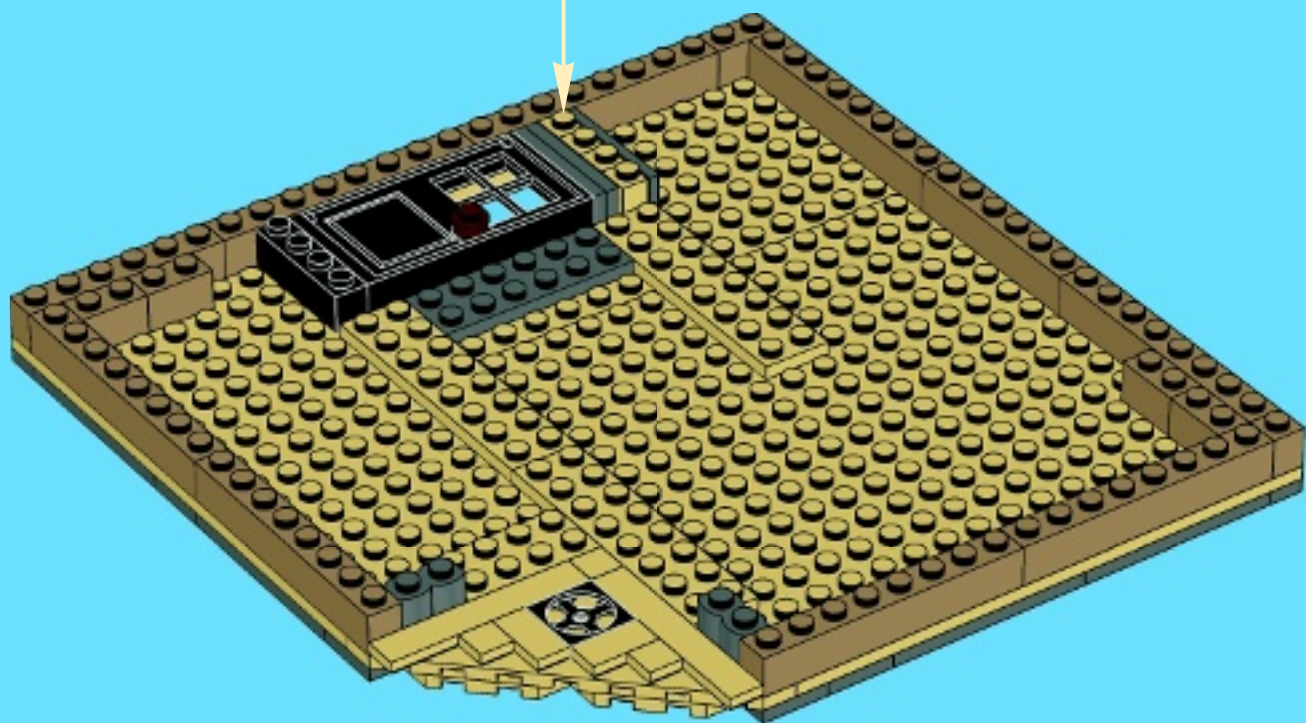
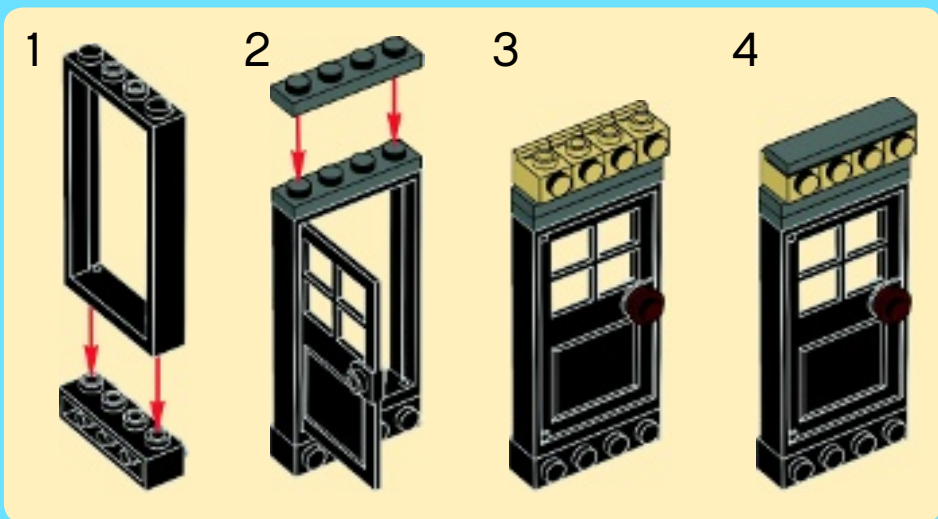

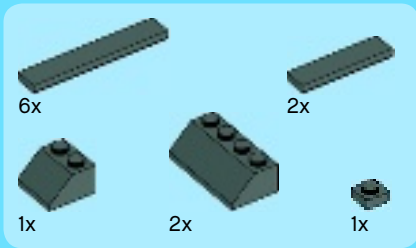

9

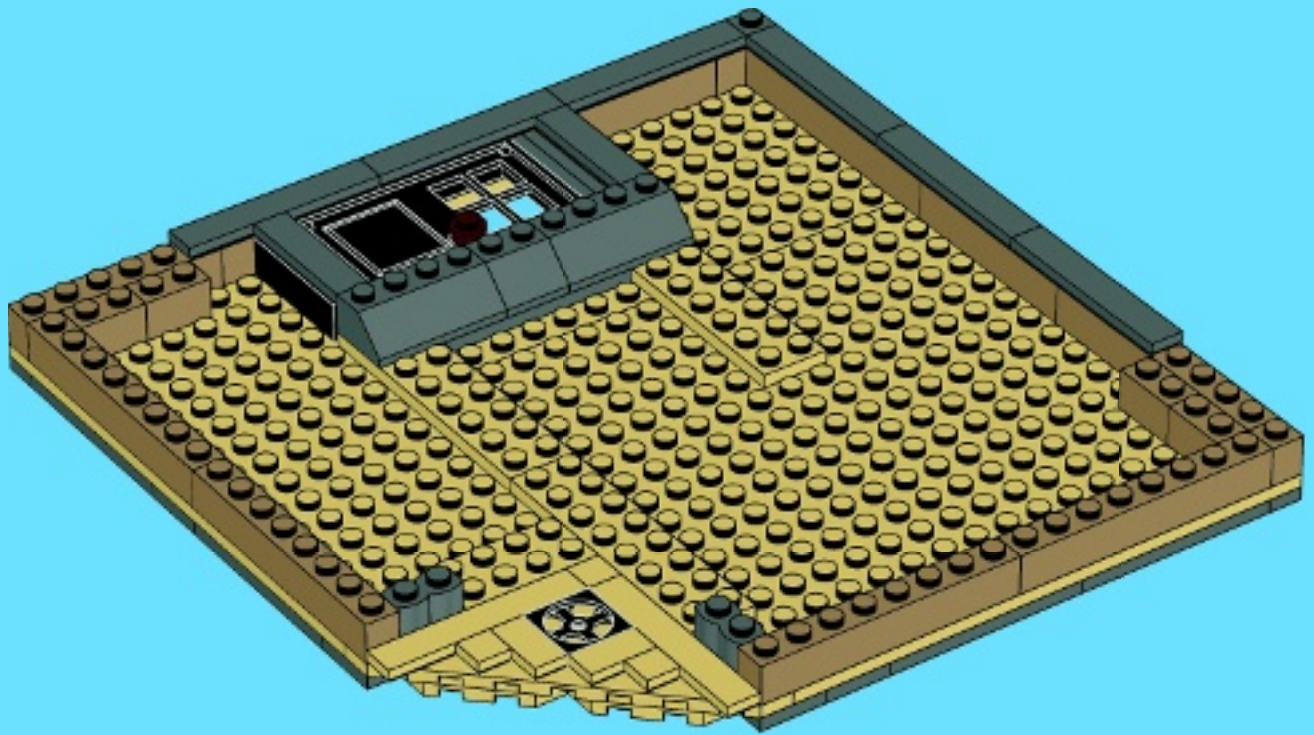





2x



1x



1x



2x

# 11

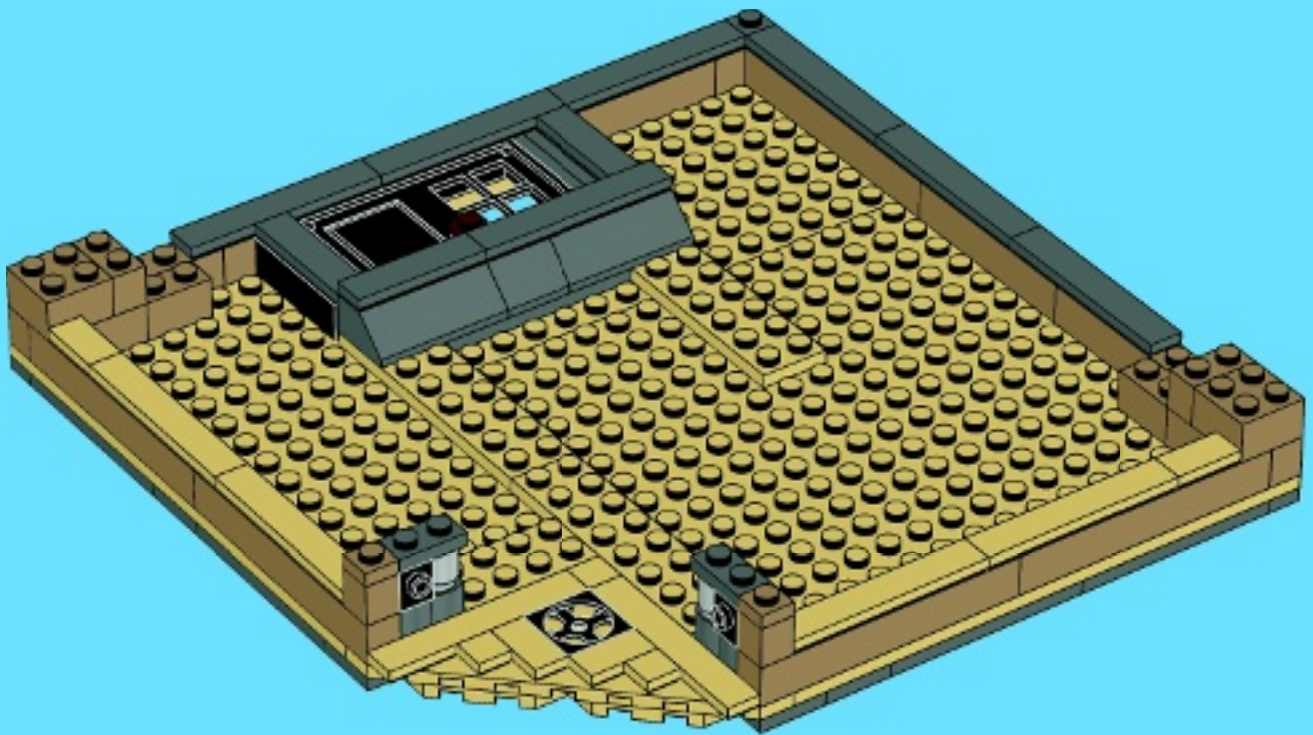



2x



2x



2x



2x

# 12

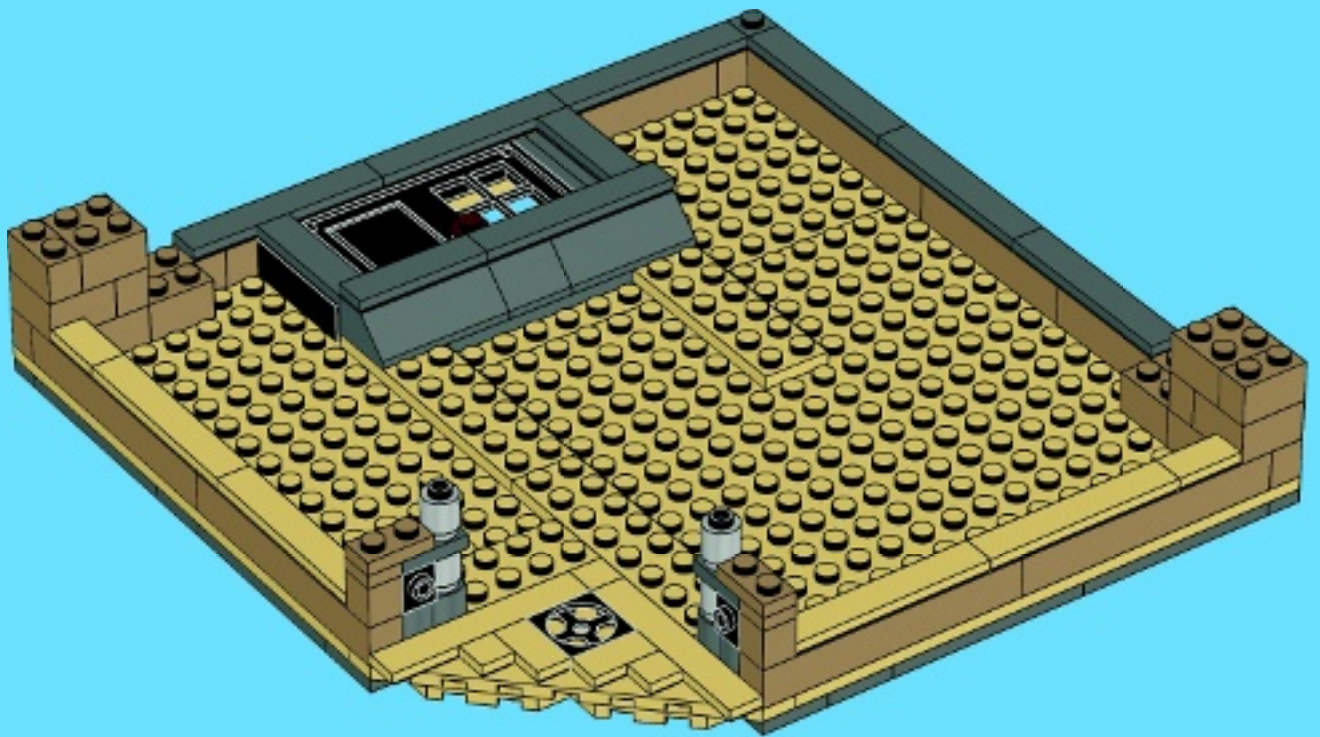

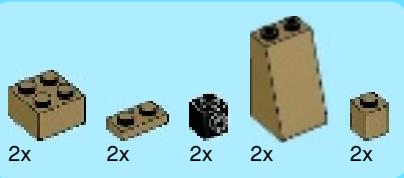

13

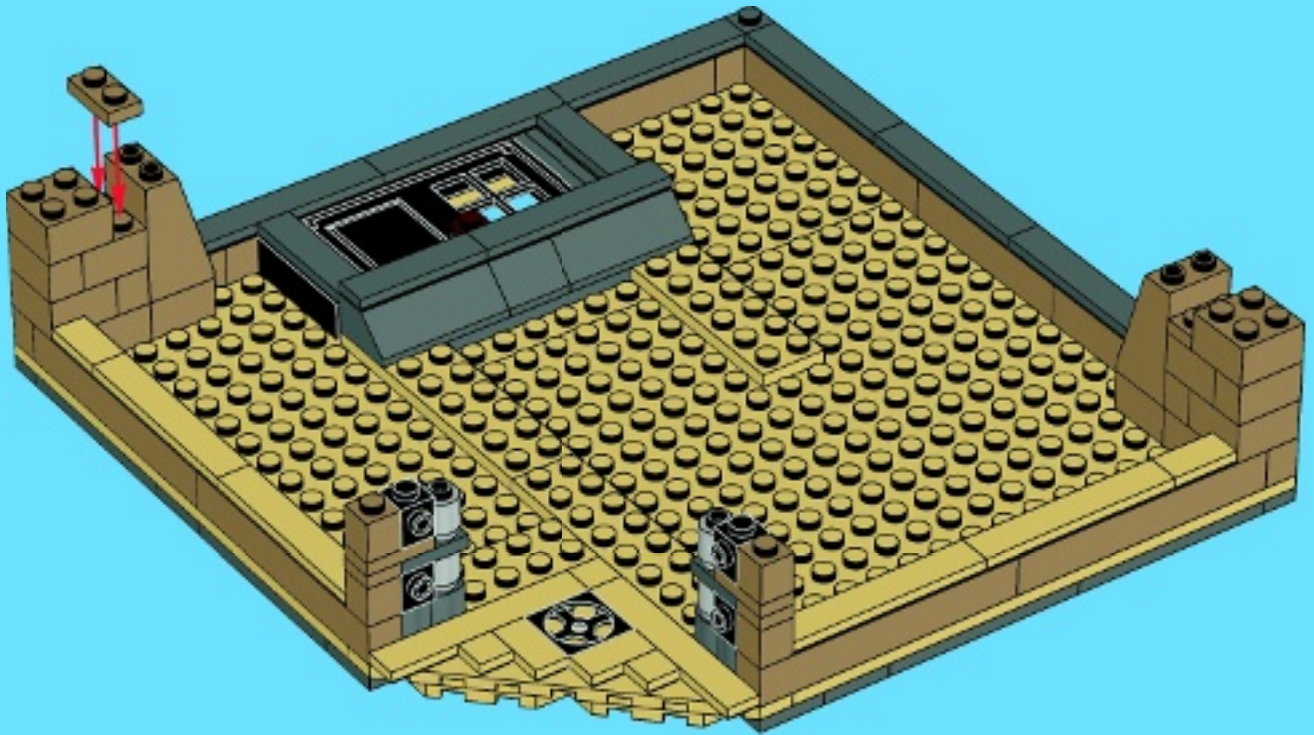



2x



6x



2x

# 14

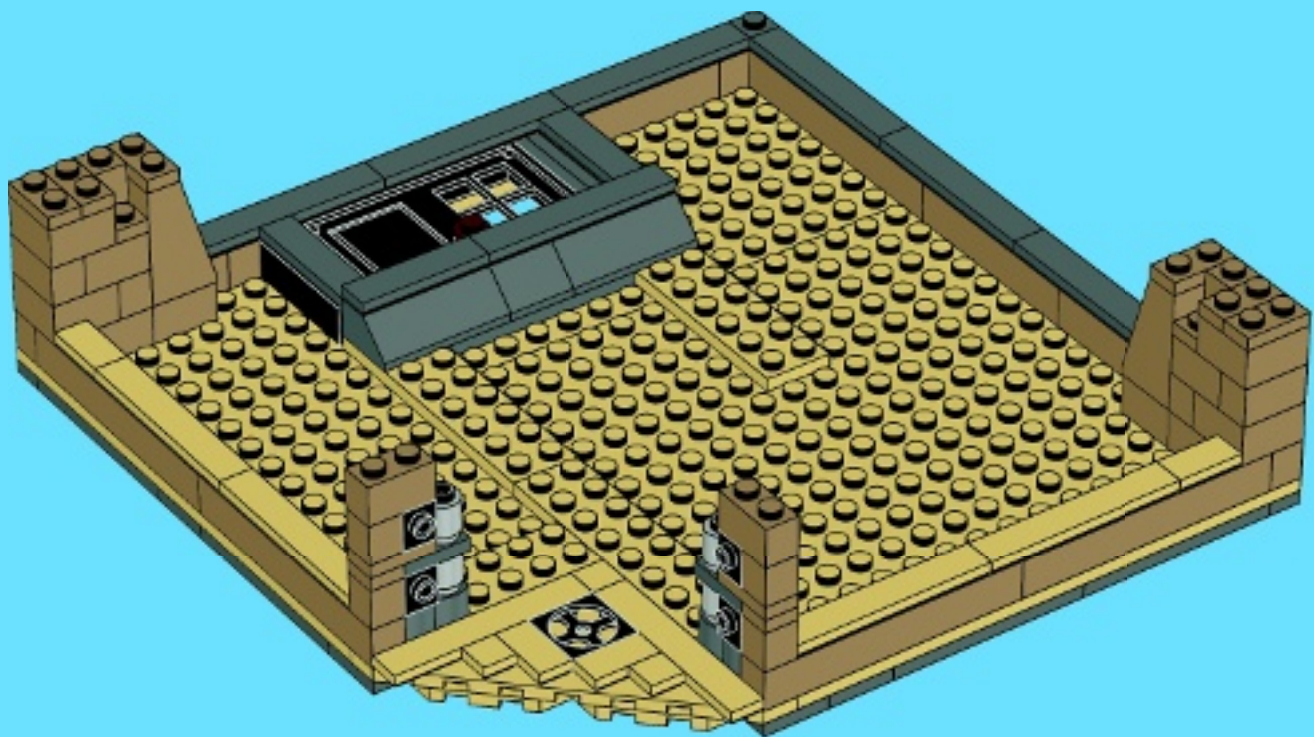

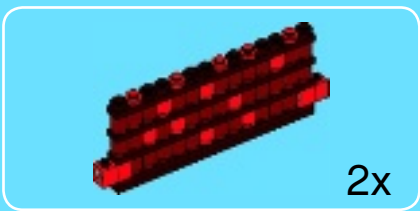

2x

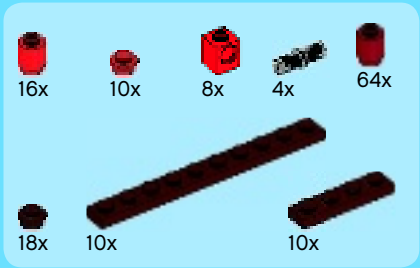

15

1

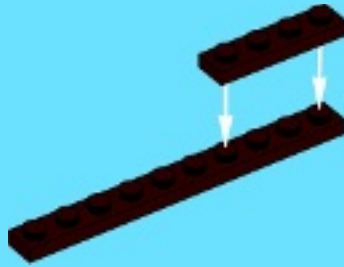

2

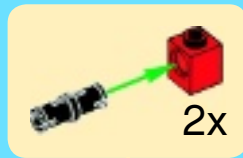
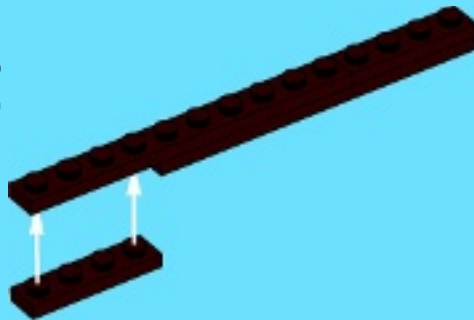

2x

3

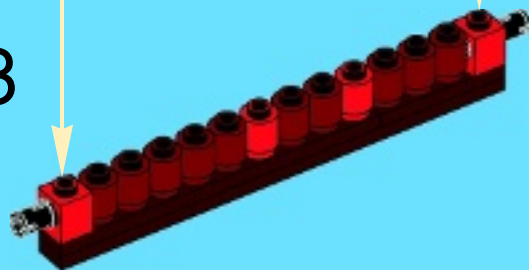



4

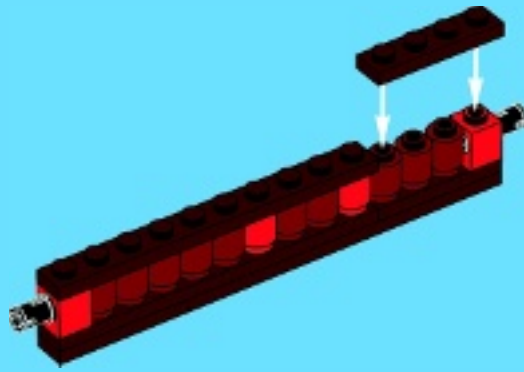

5

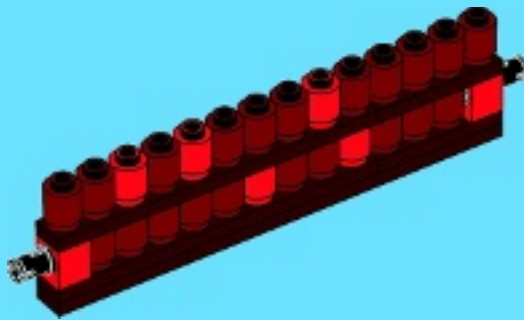

6

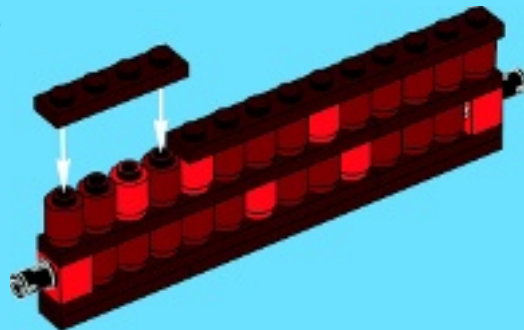

7

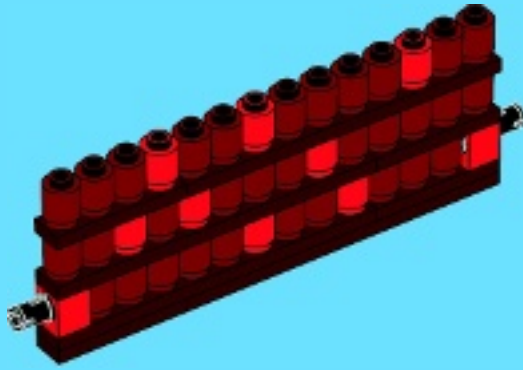

8

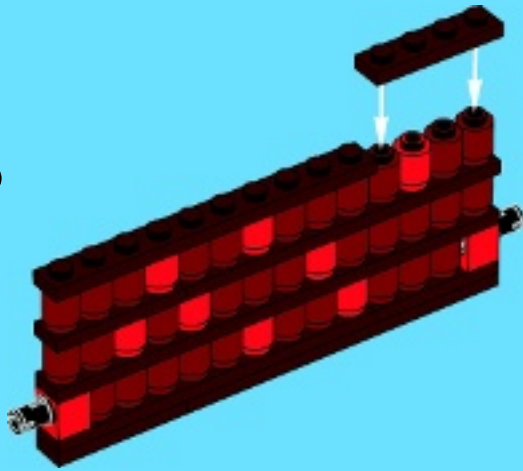

9

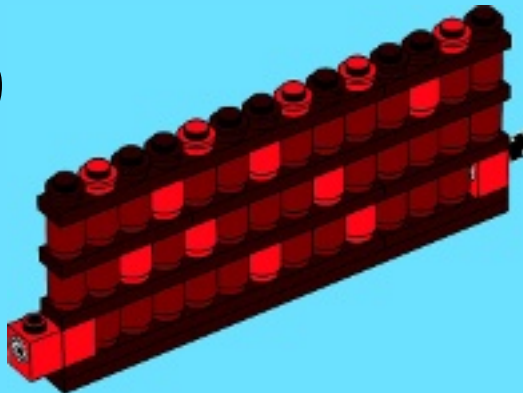

2x

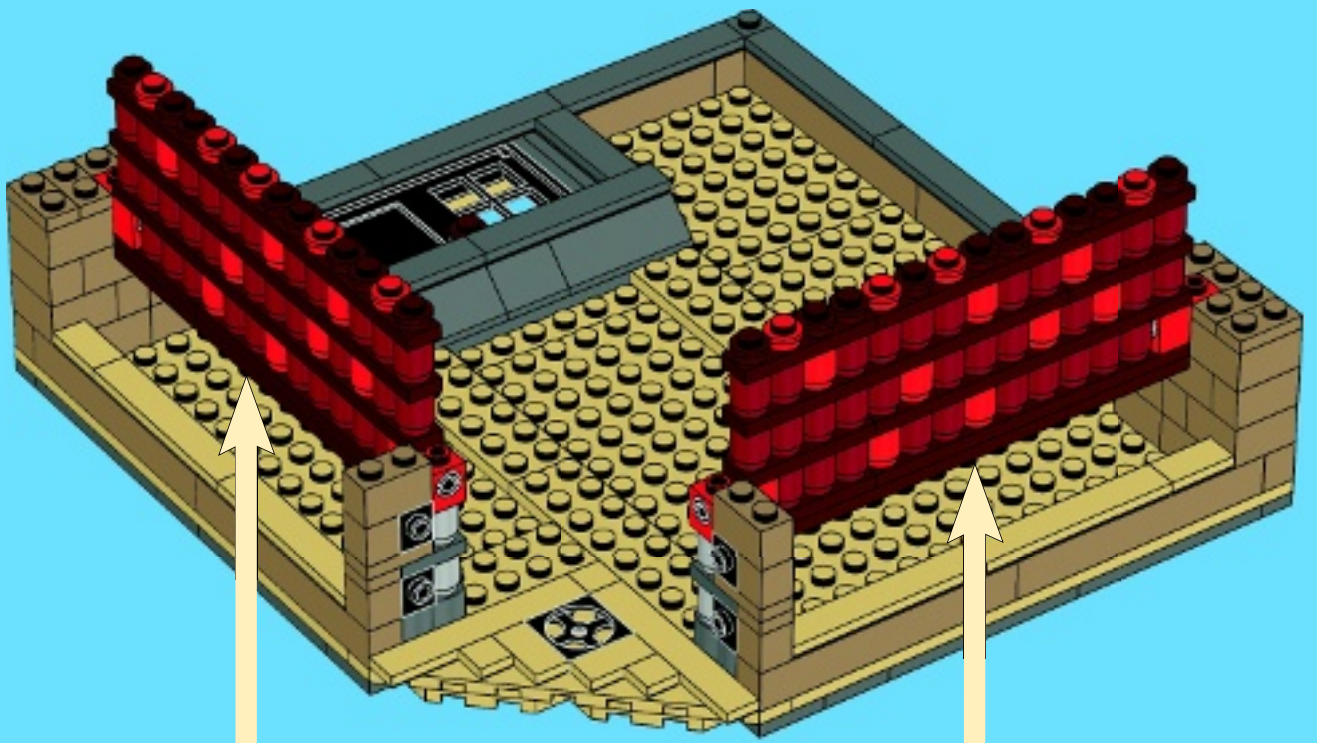

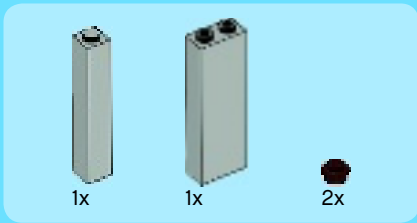

# 16

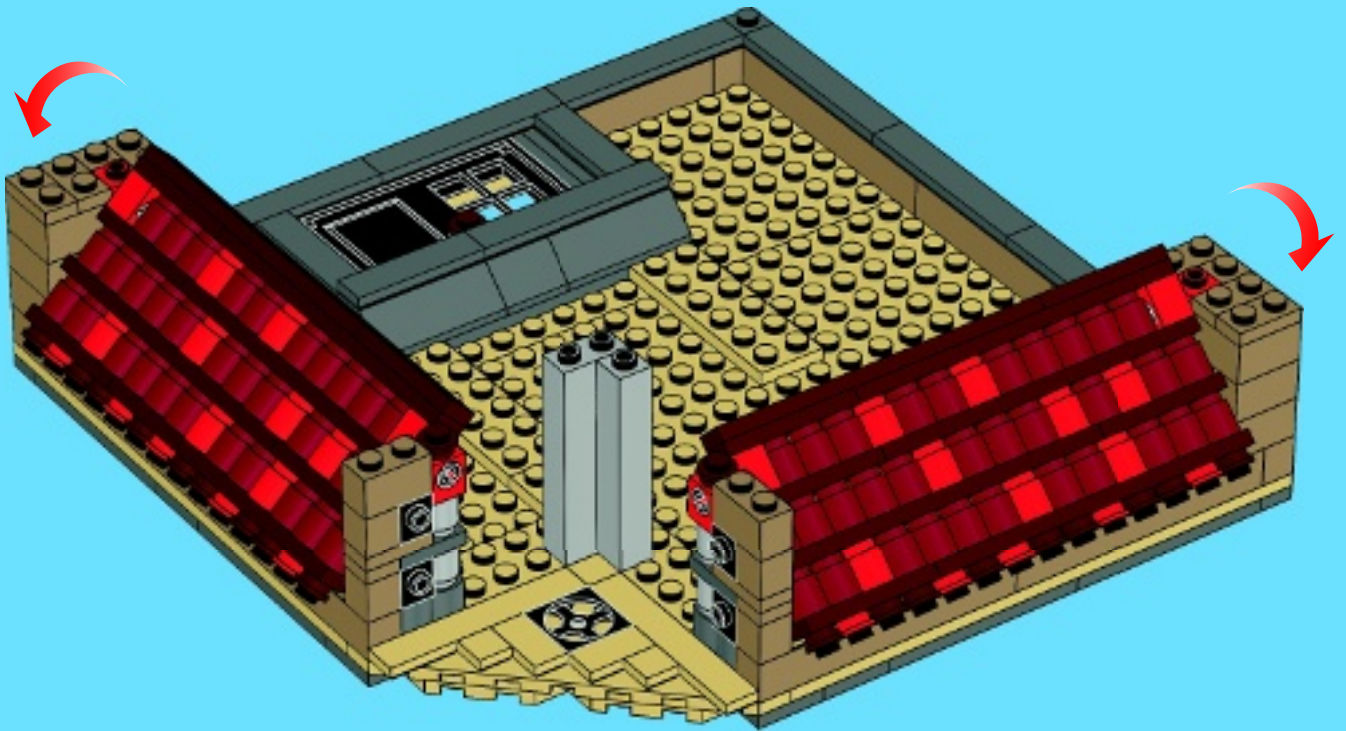

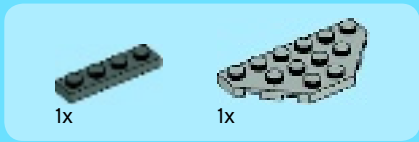

1

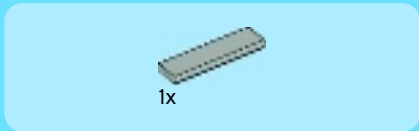
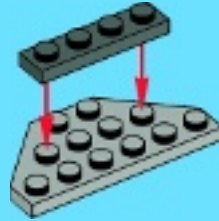

2

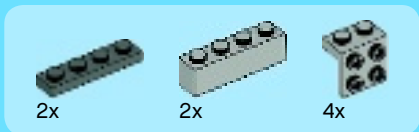
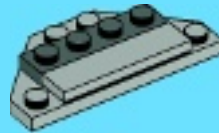

3

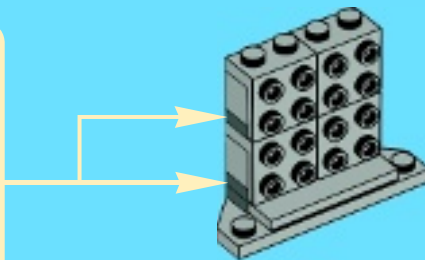
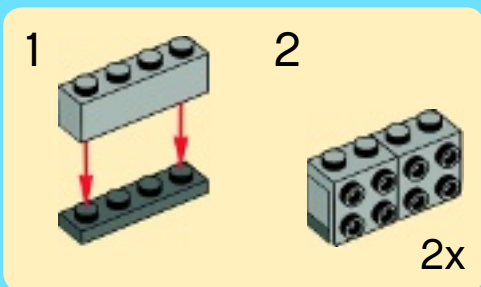



2x



1x



2x

# 4

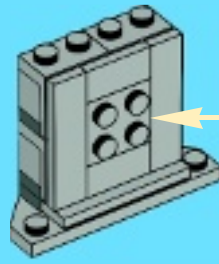

6x



4x

# 5

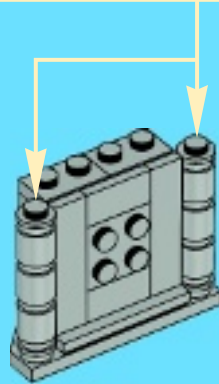
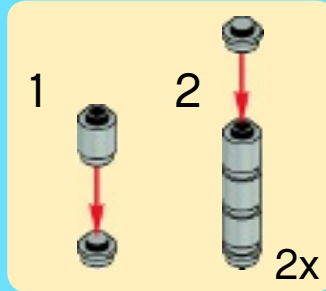

2x



1x



1x

# 6

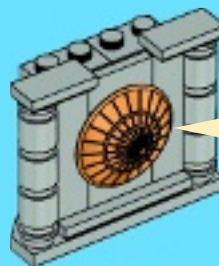

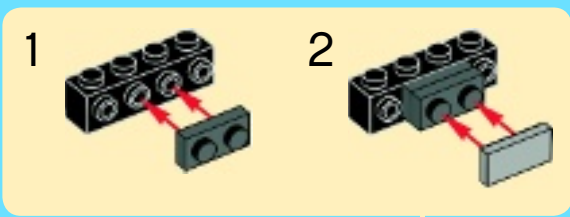
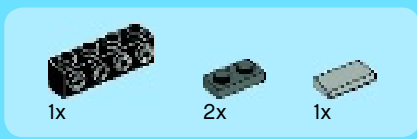

7

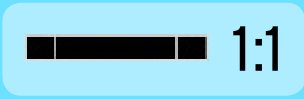
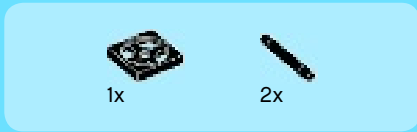
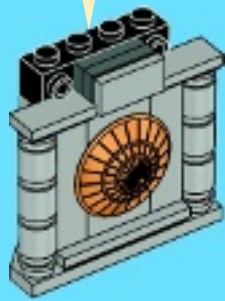

8

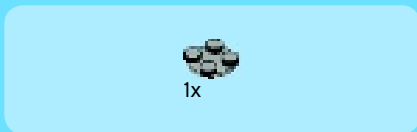
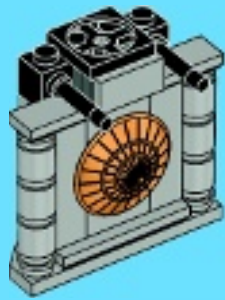

9





10

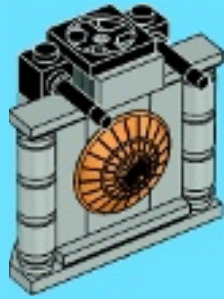

17

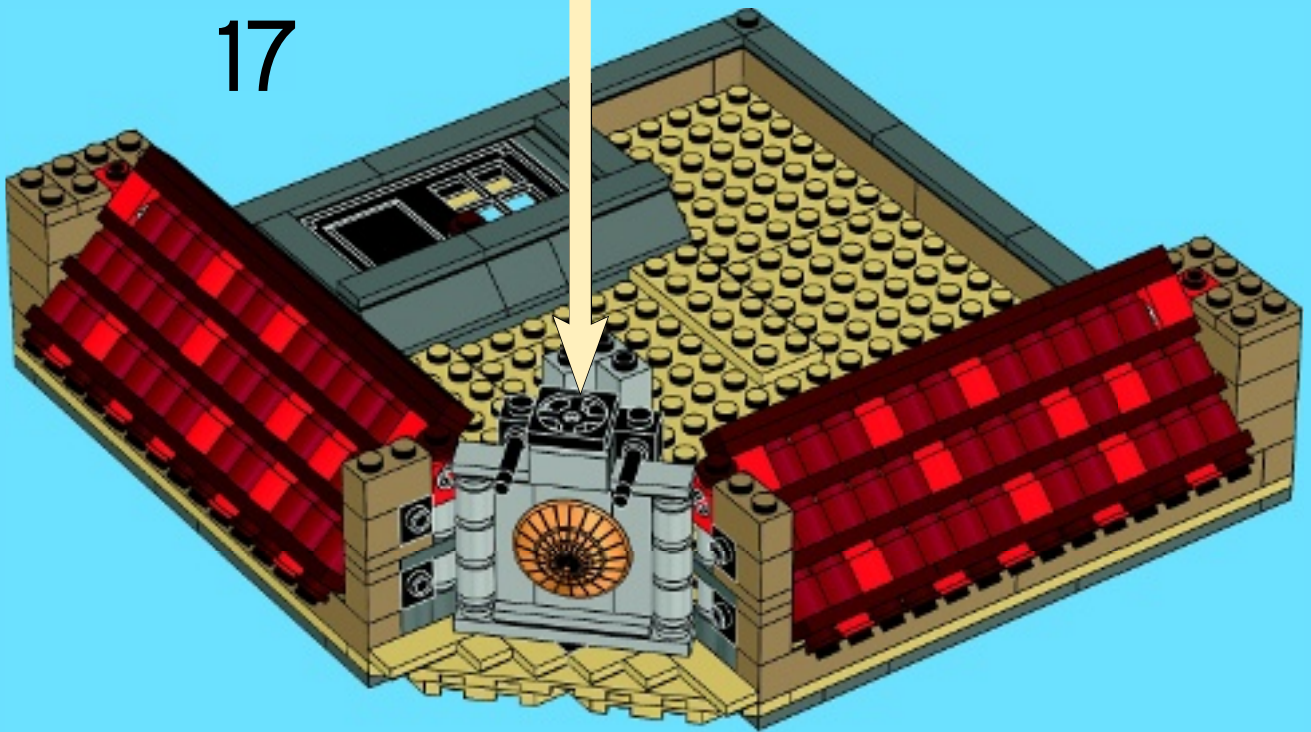





2x



4x

# 18

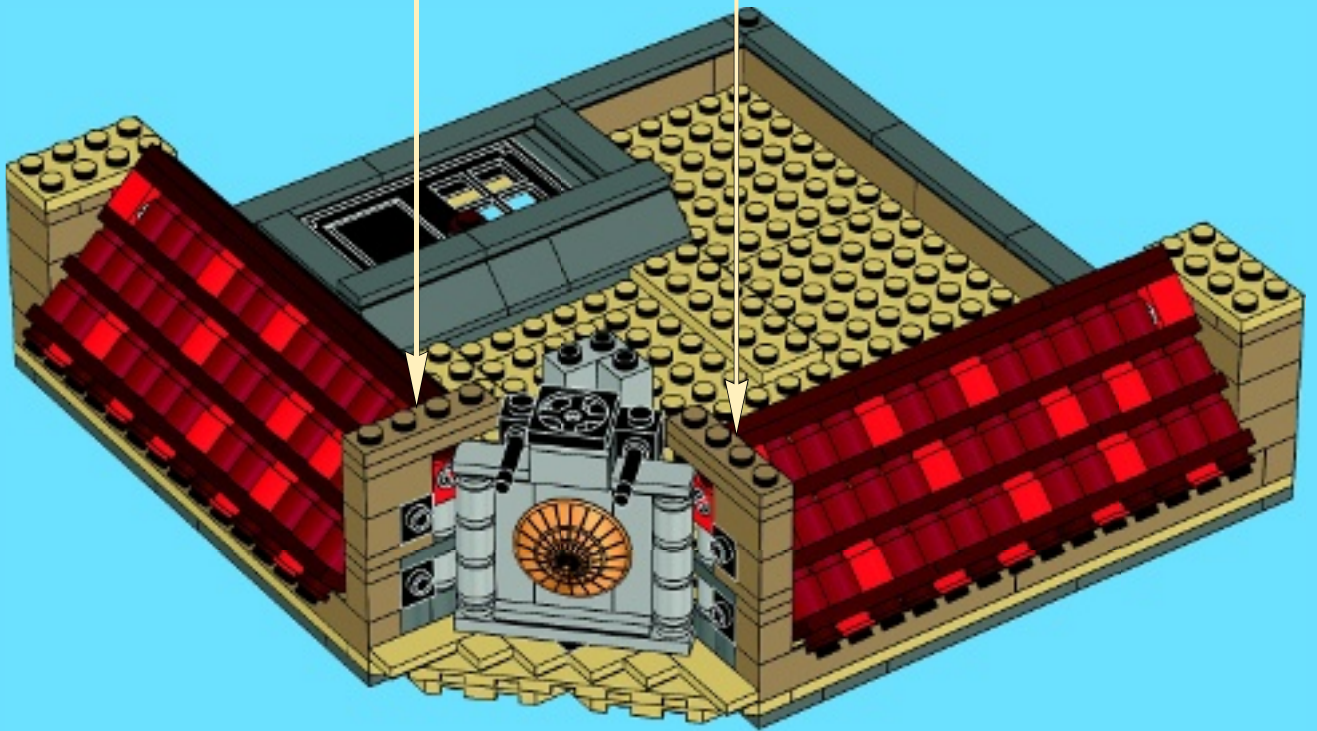
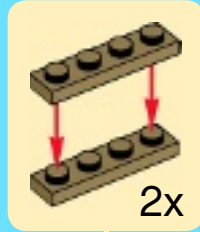

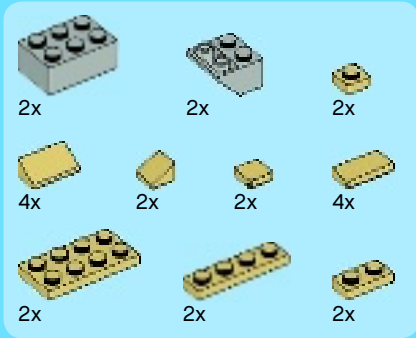

# 19

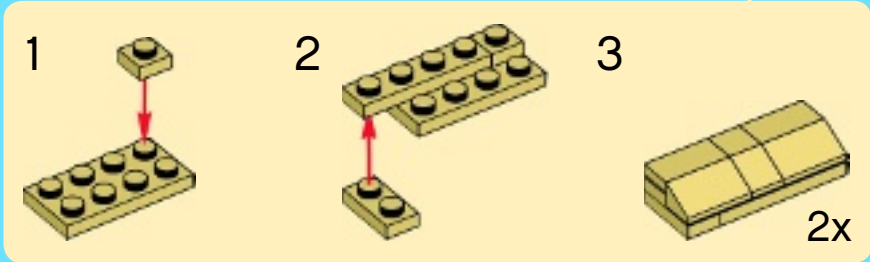
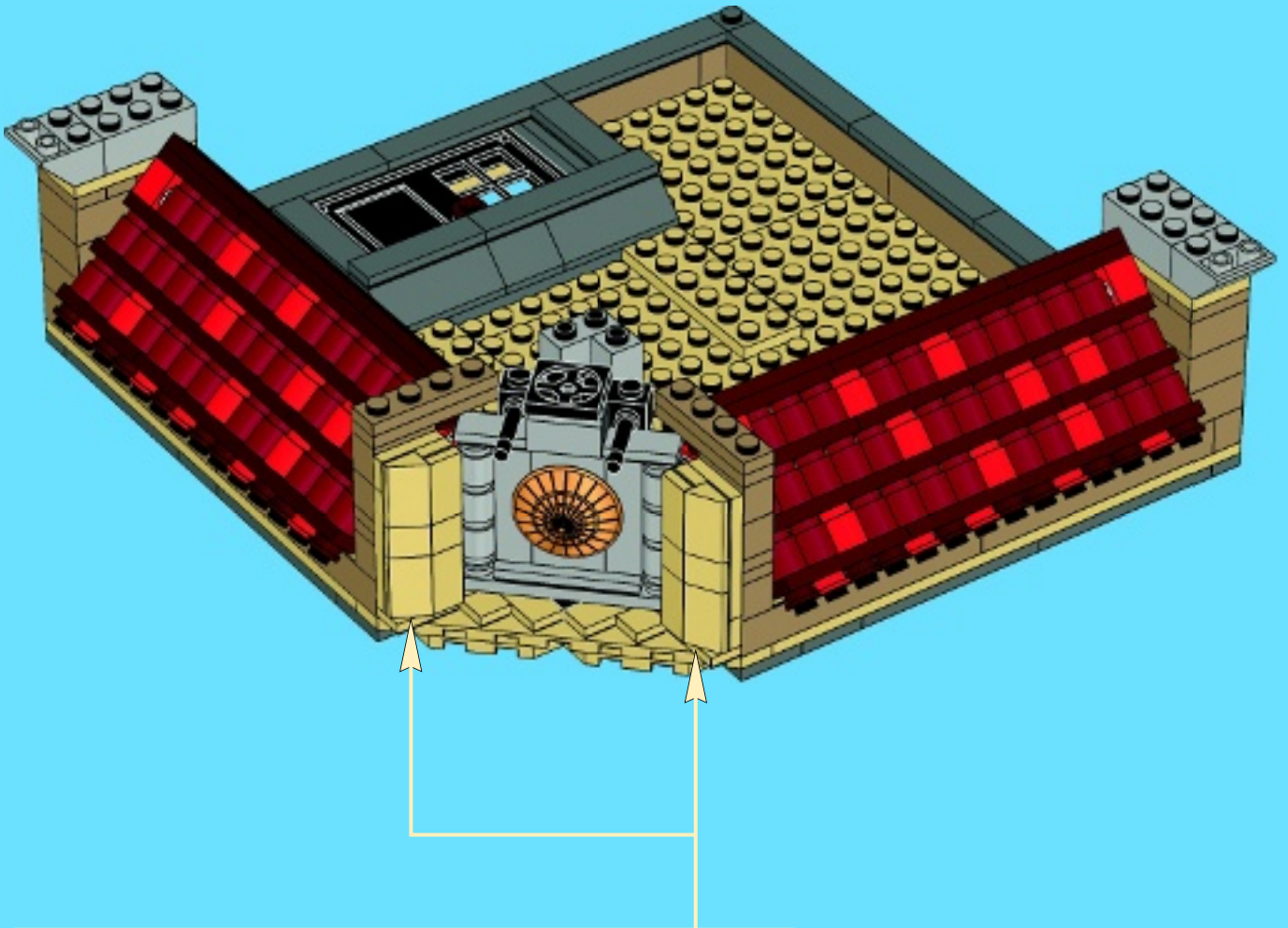

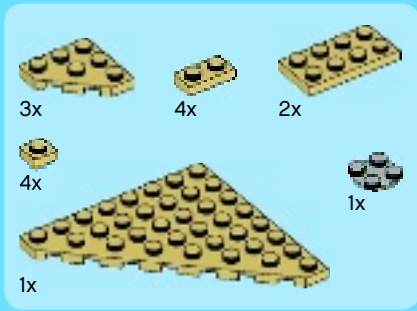

20

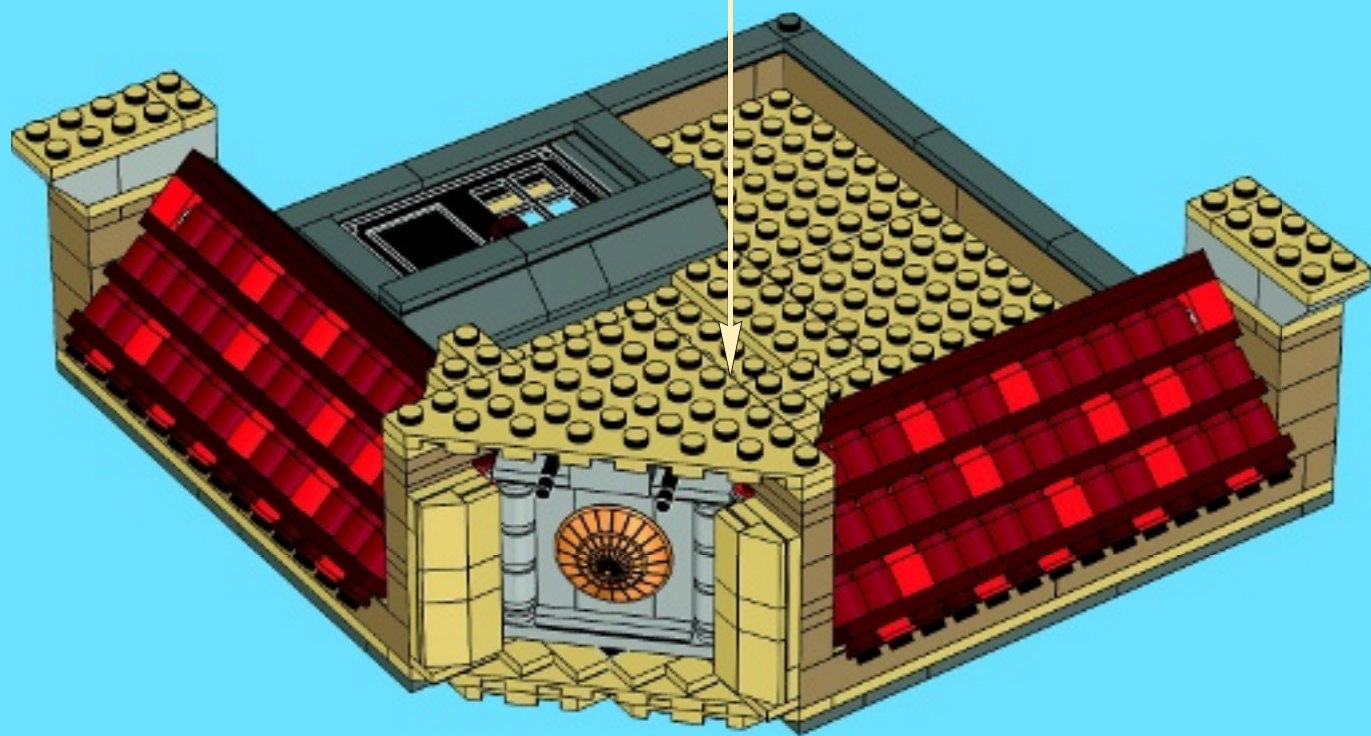
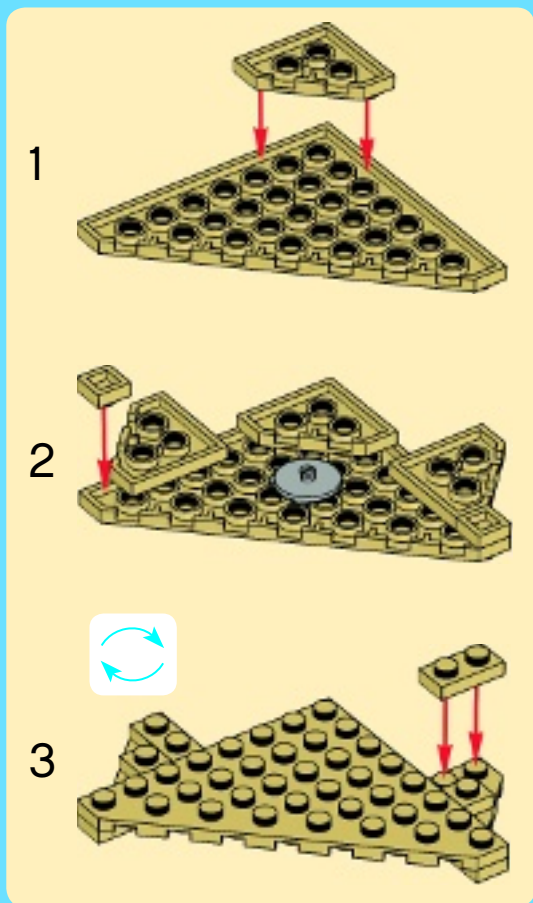

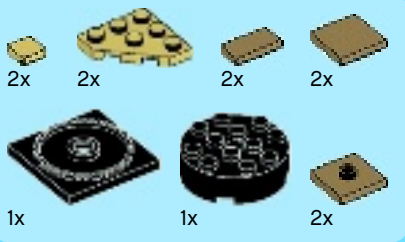

21

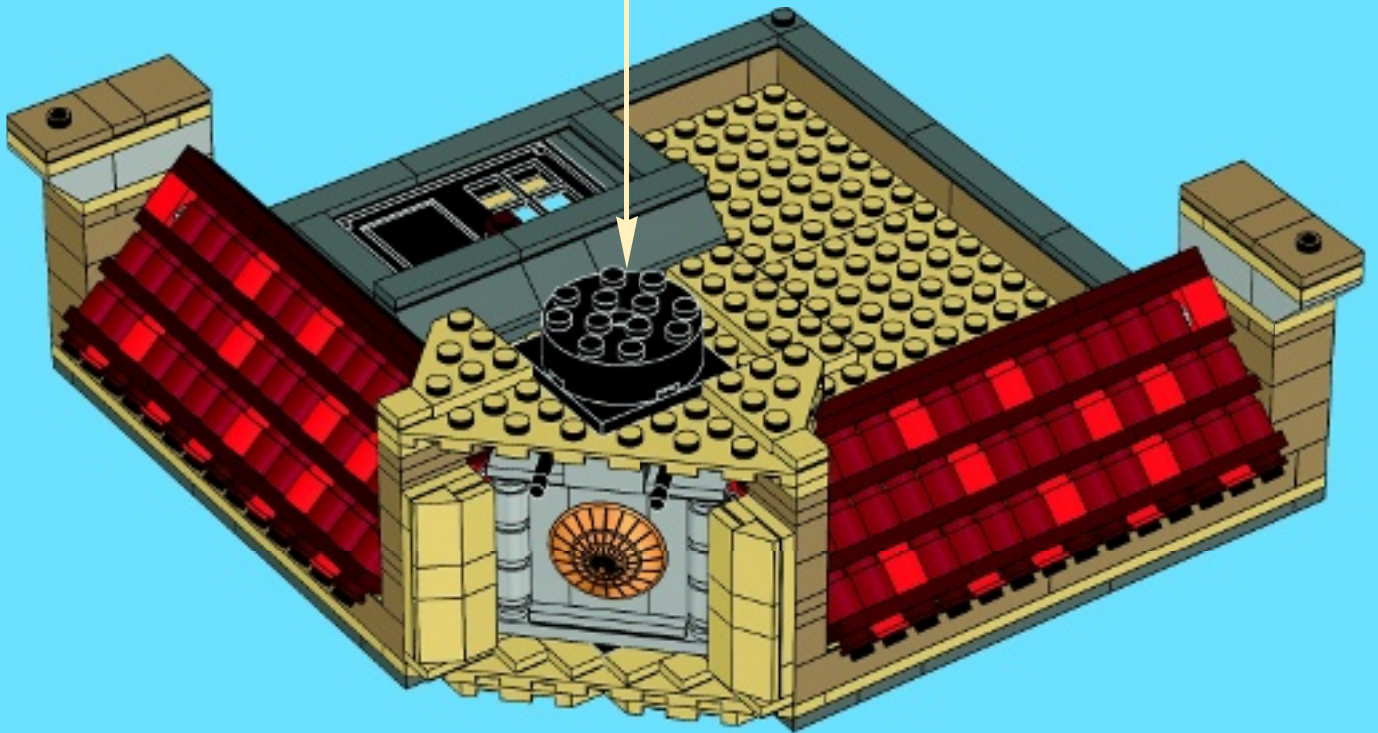
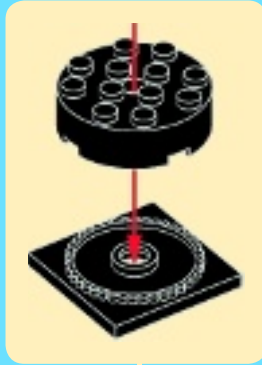

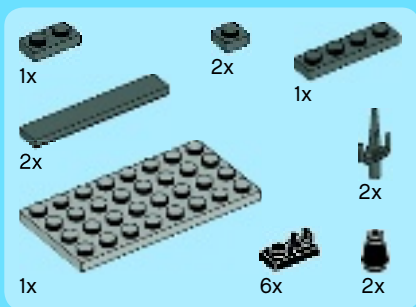

22

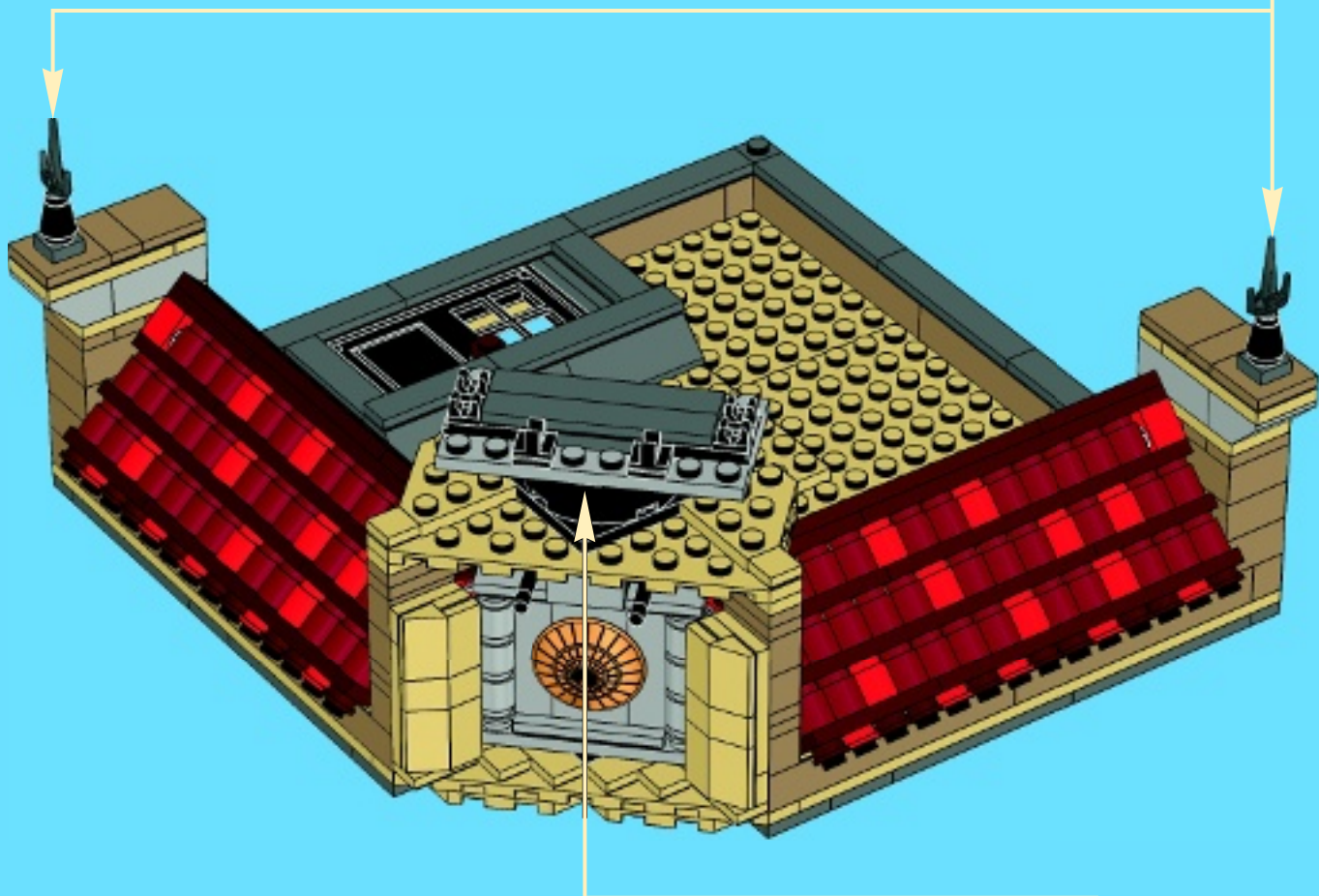
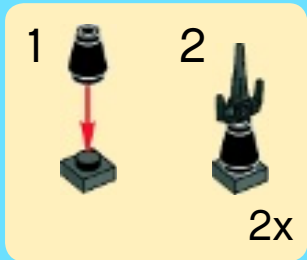

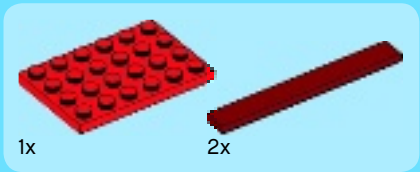
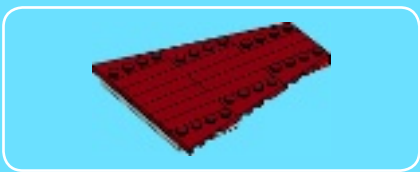

1x

2x

1

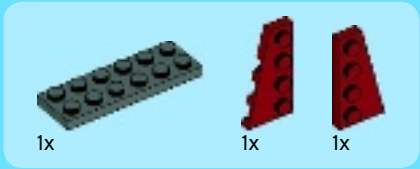
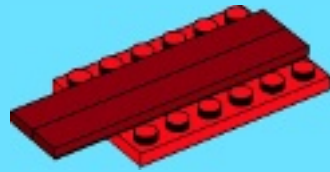

1x

1x

1x

2

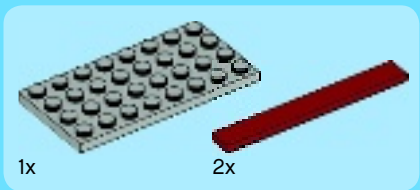
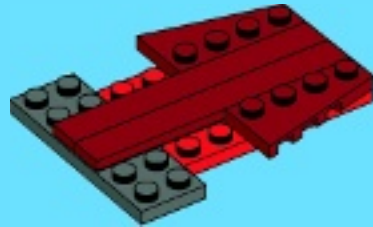

1x

2x

3

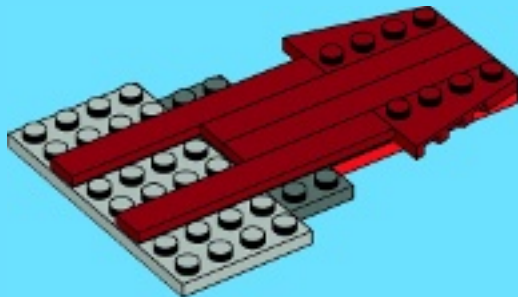

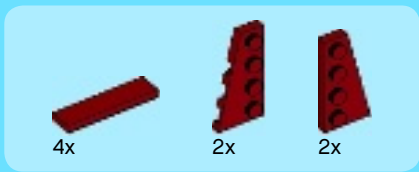

4

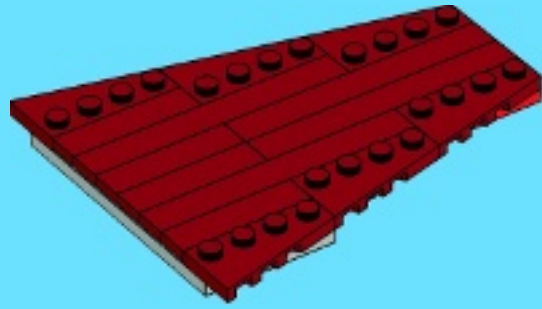

5

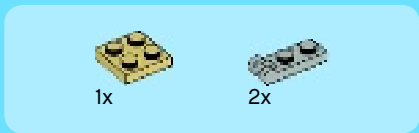
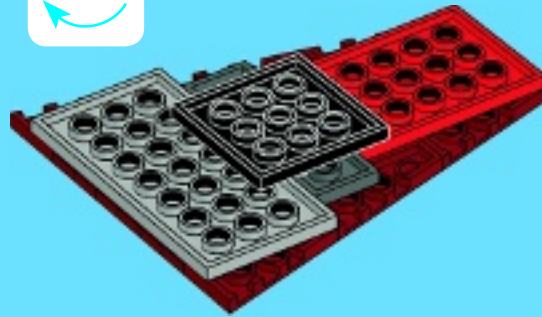

6

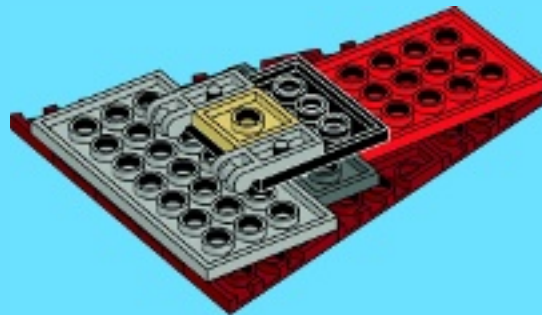



2x

7

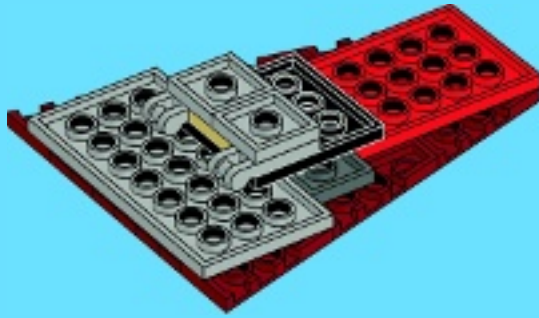

23

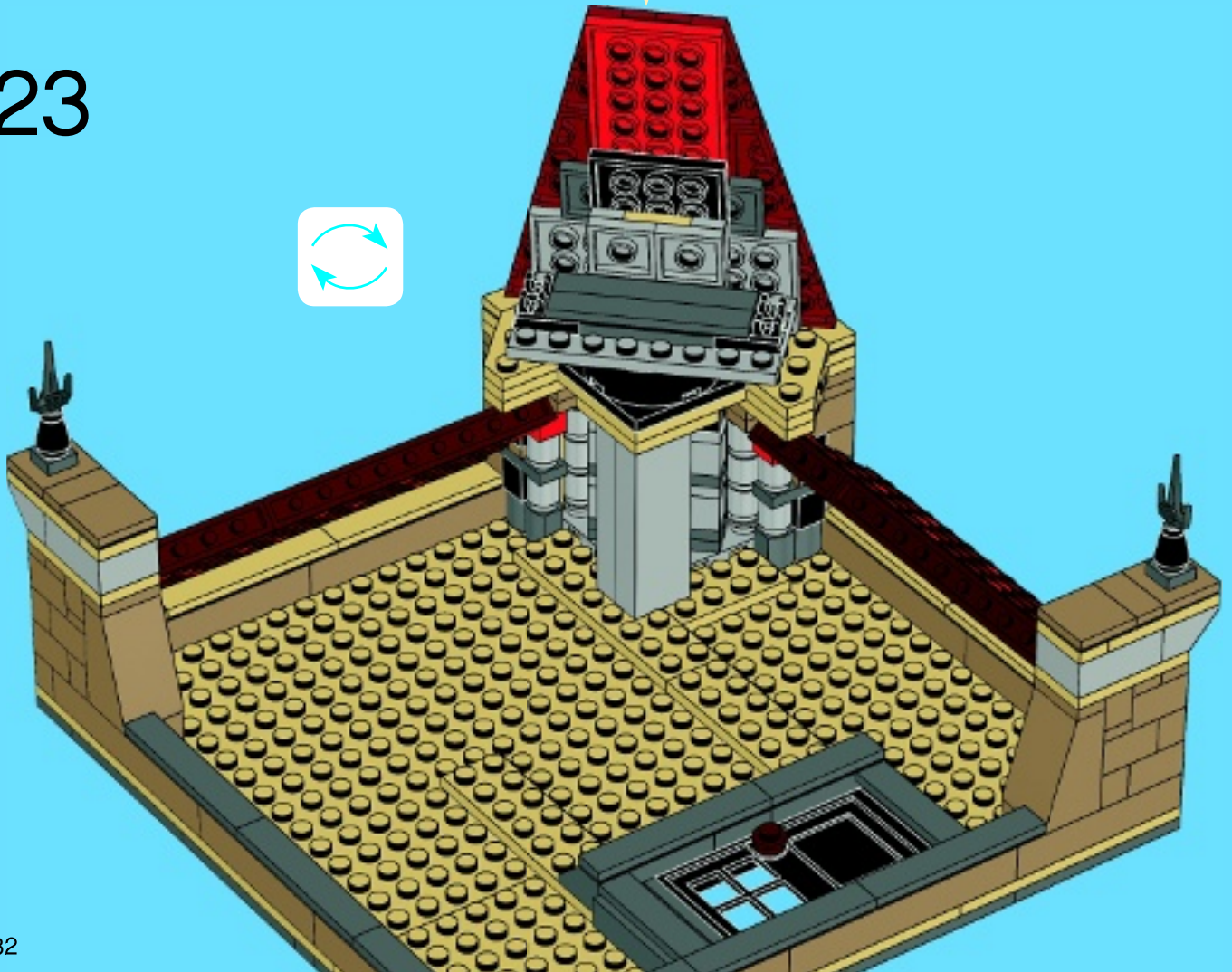



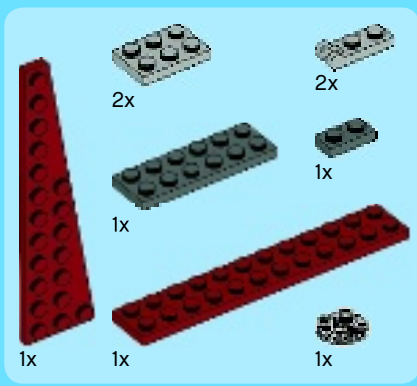

24

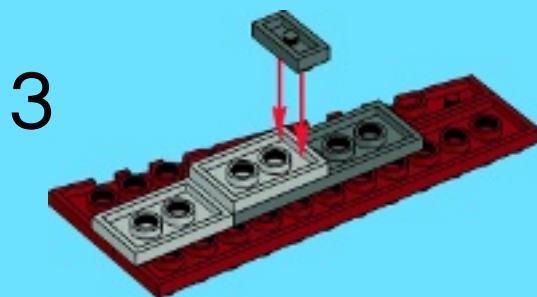
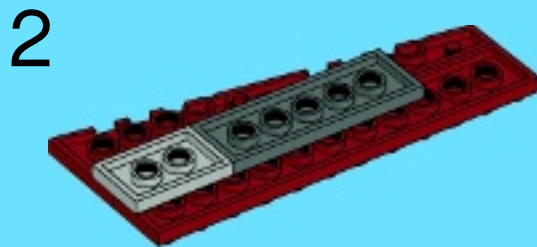
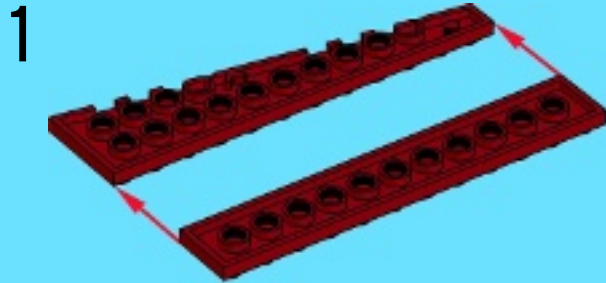

4

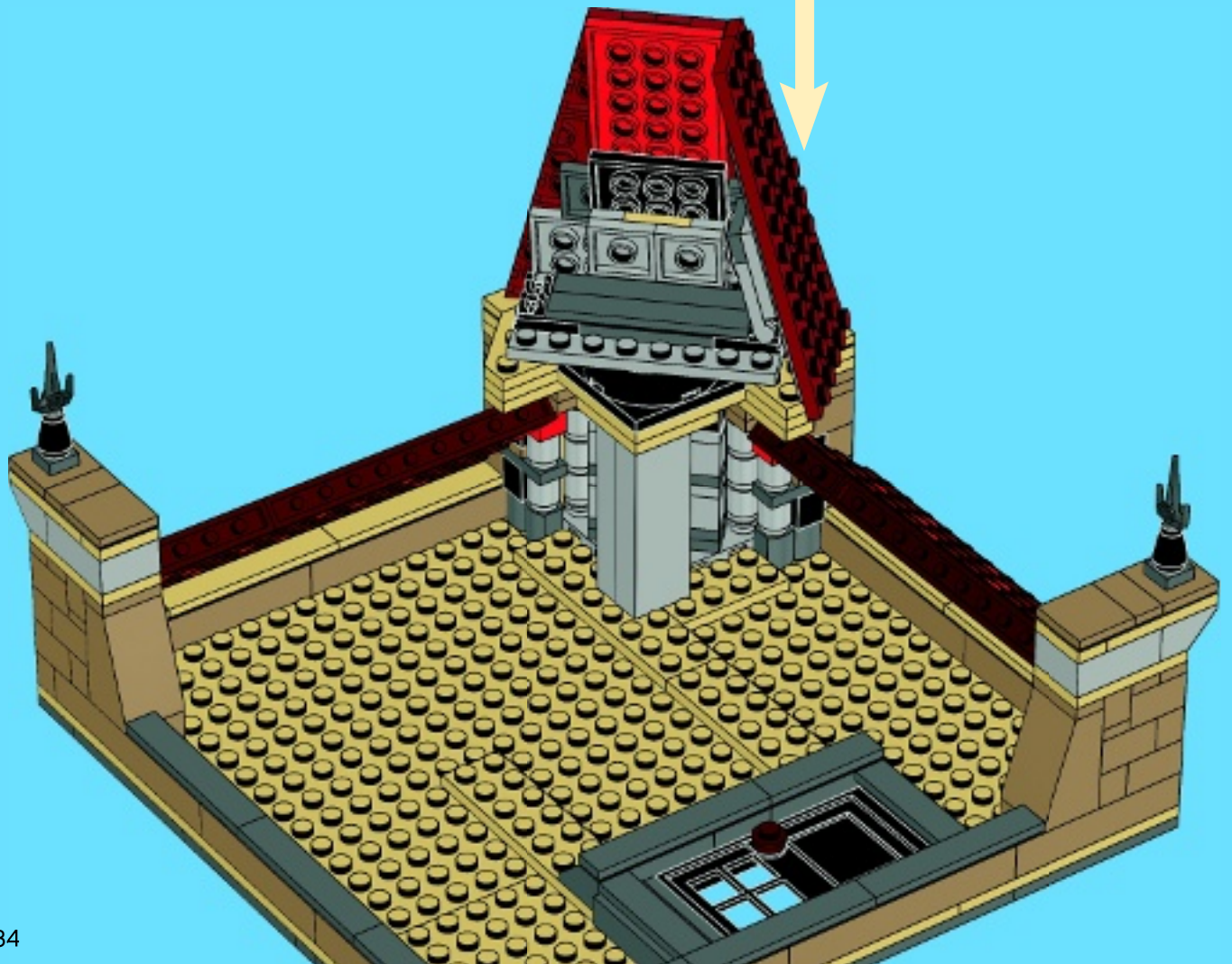
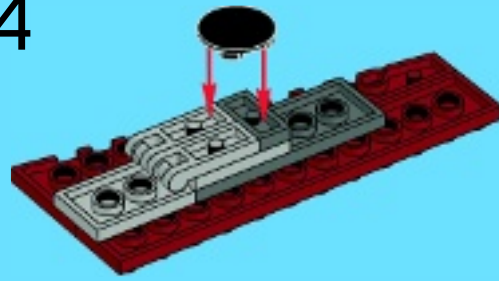

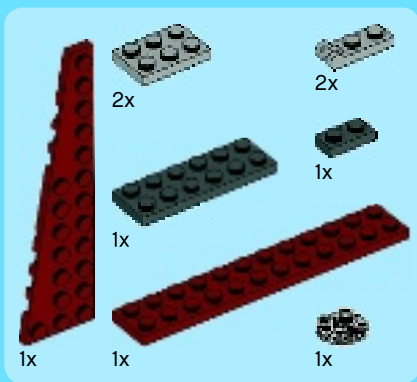

25

1

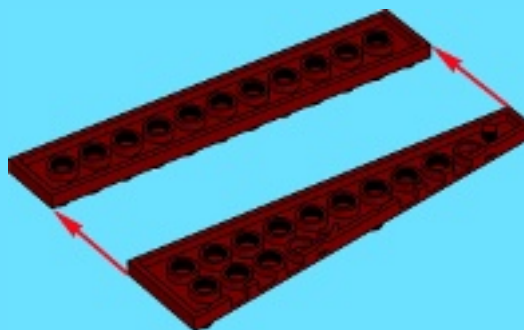

2



3

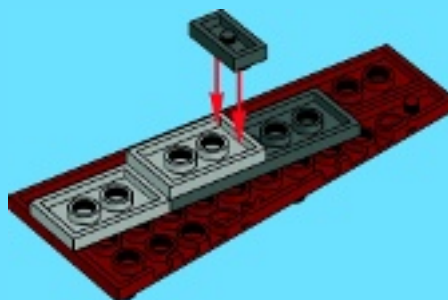

4

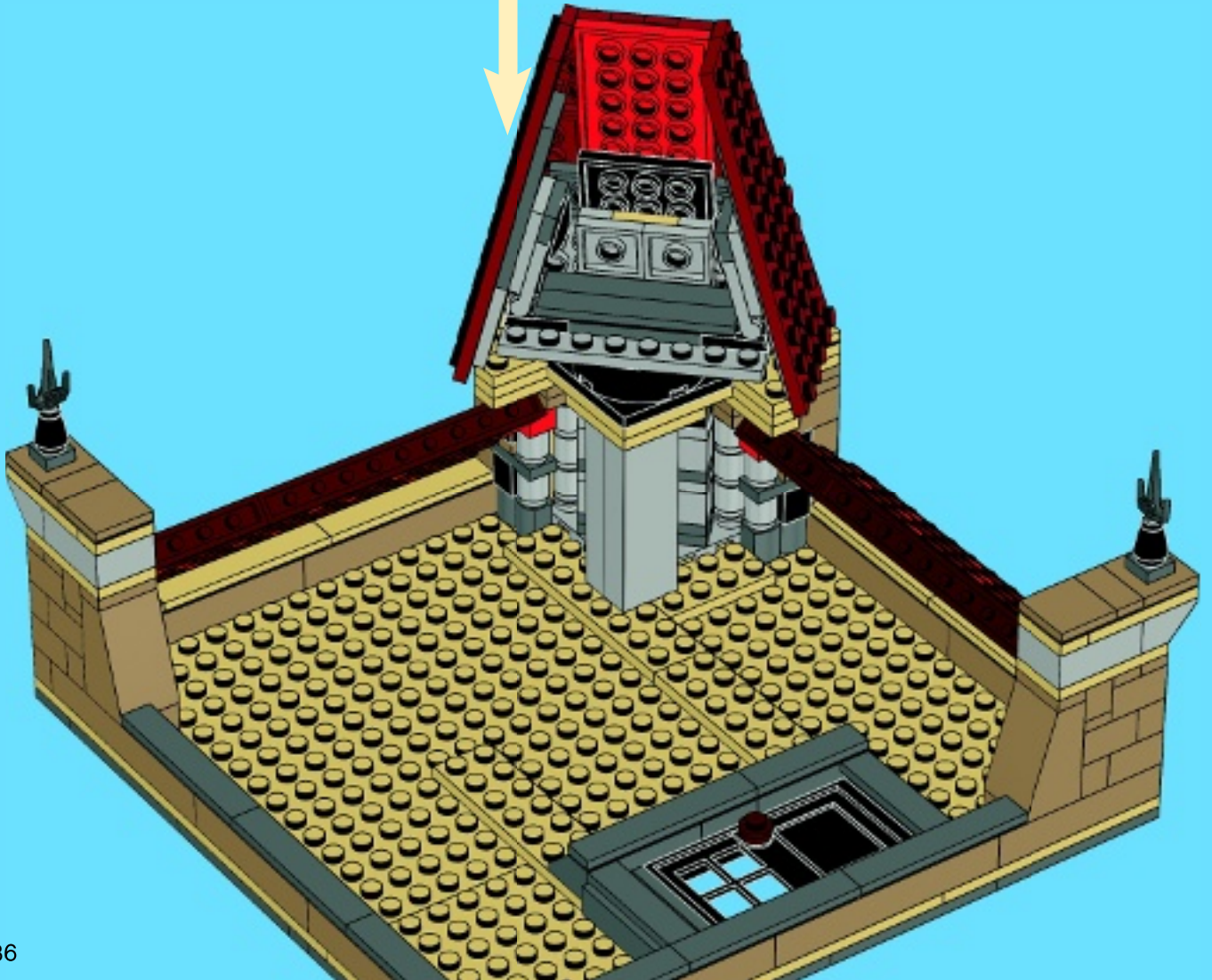
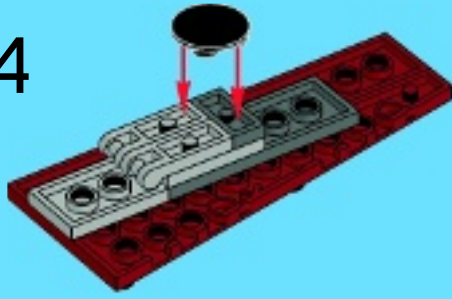

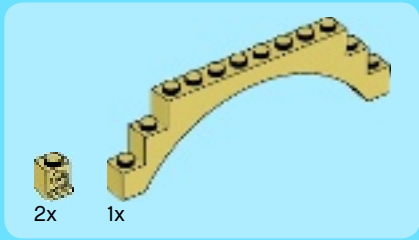
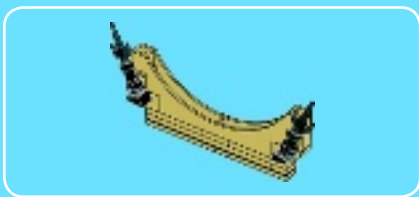

1

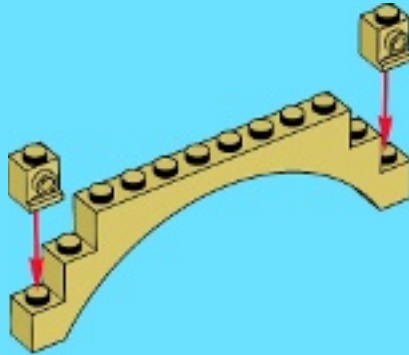

2

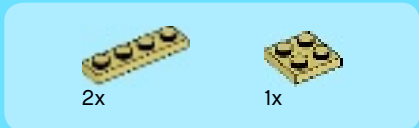
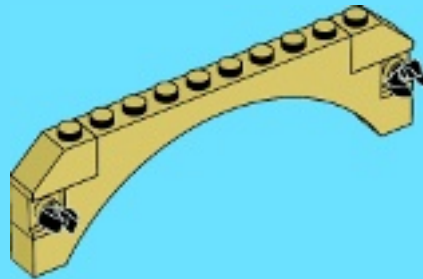

3

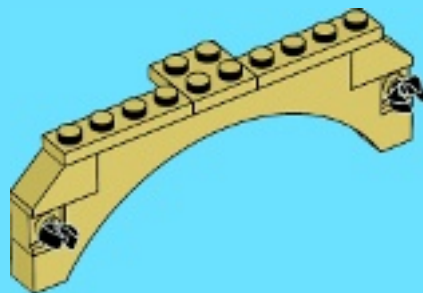

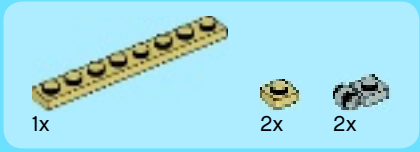

4

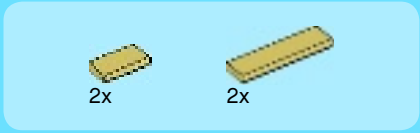
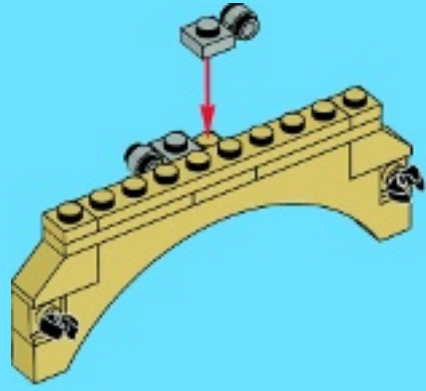

5

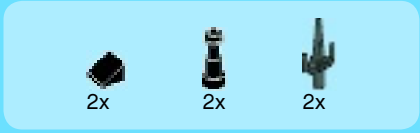
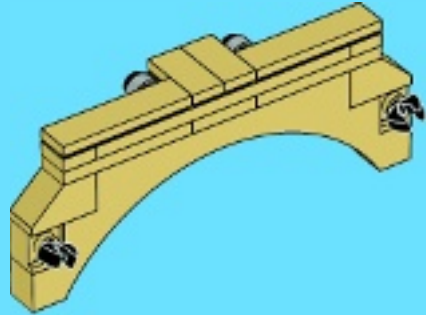

6

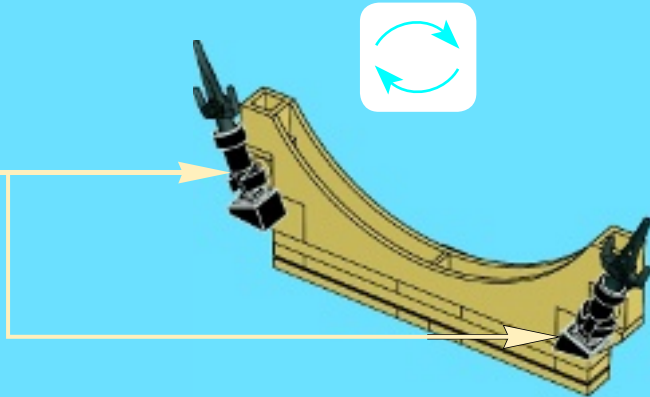



26

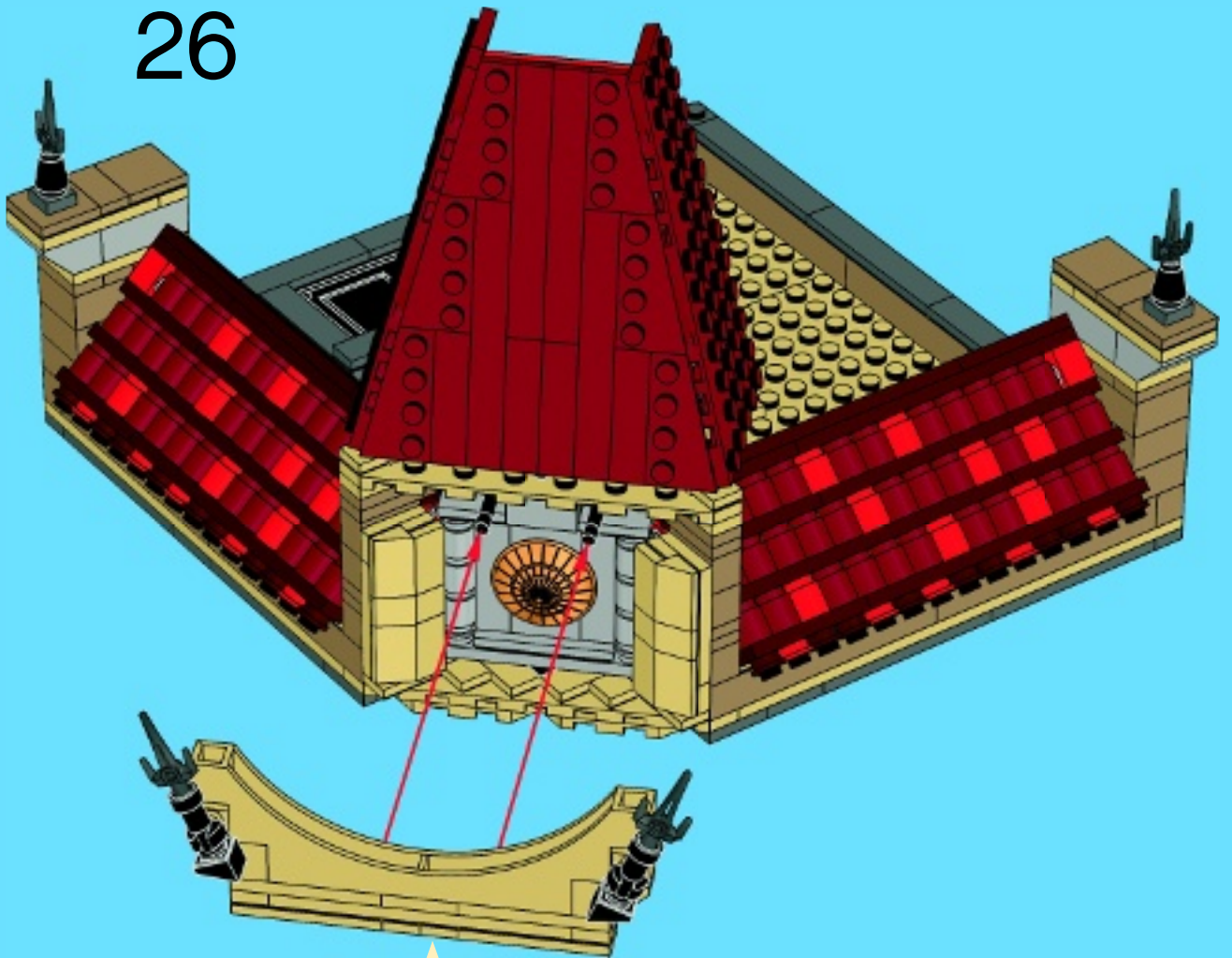

27

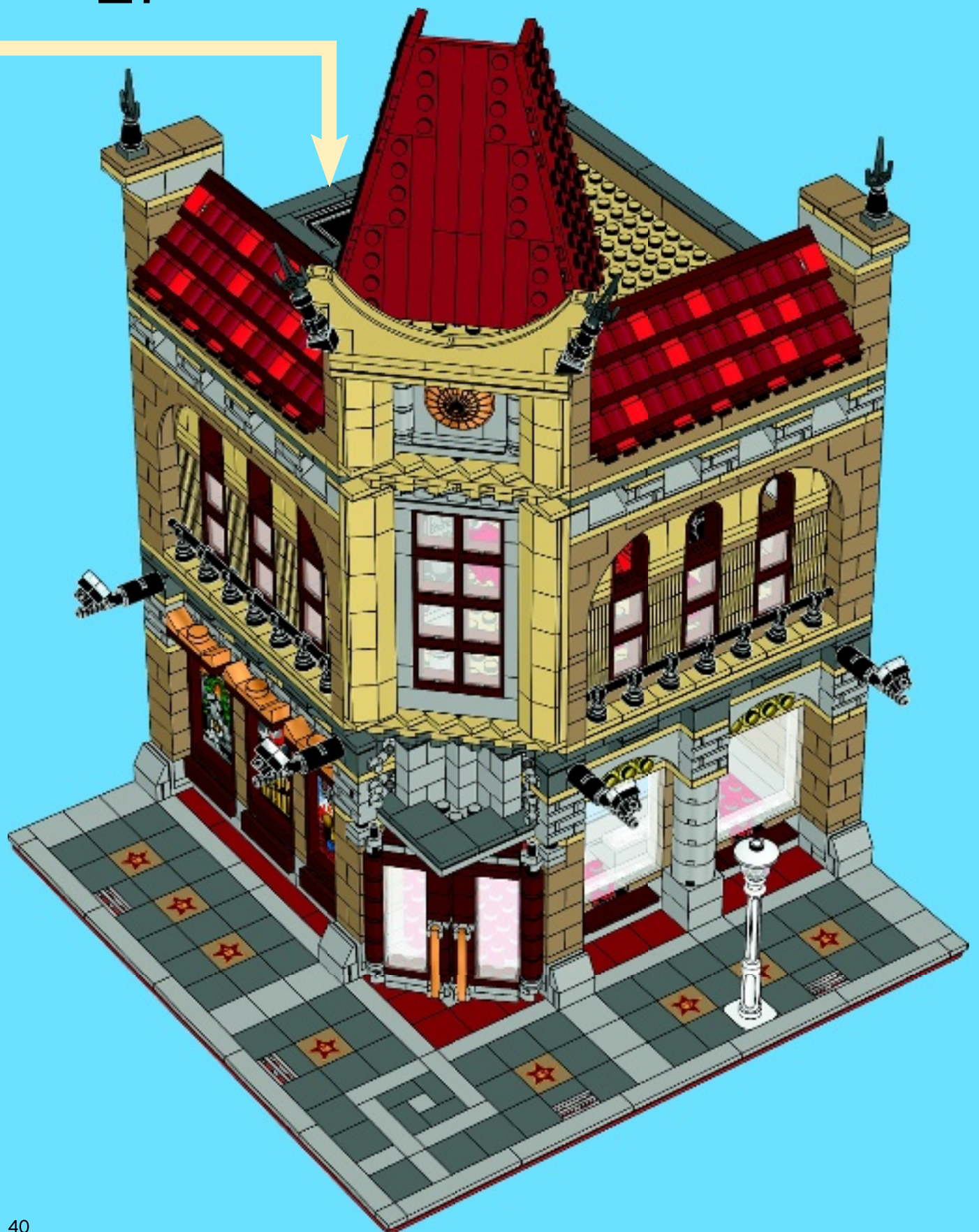



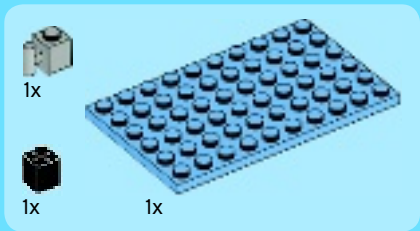
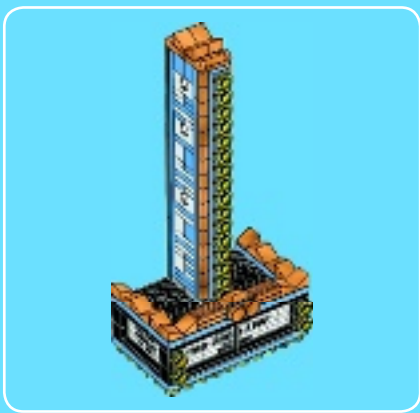

1



2

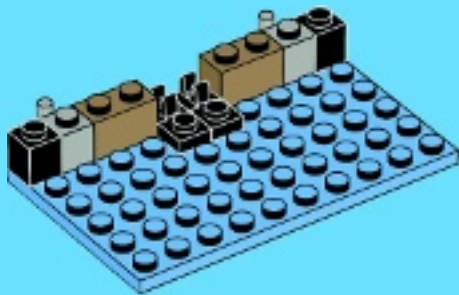



3

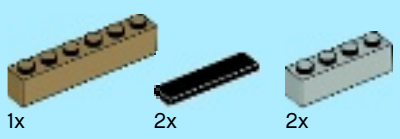
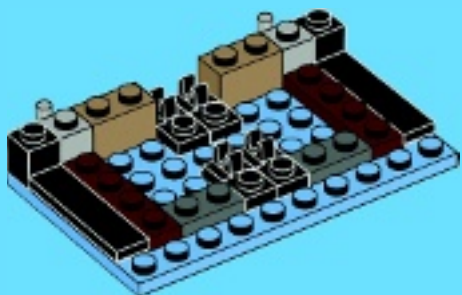

4

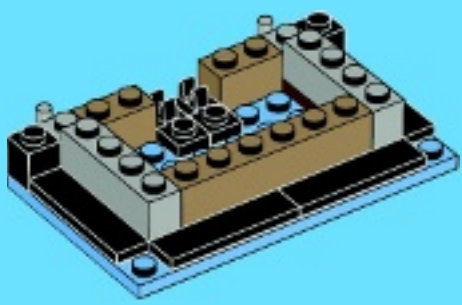

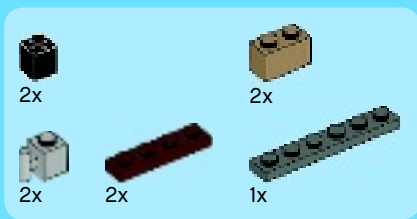

5

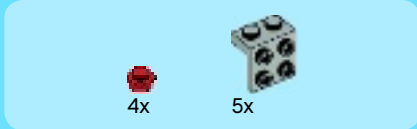
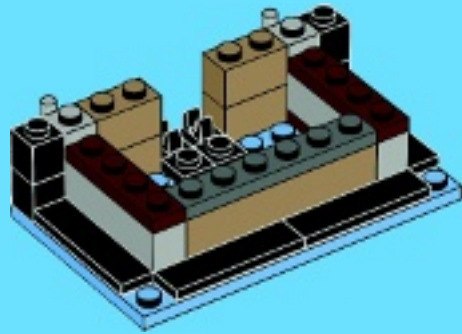

6

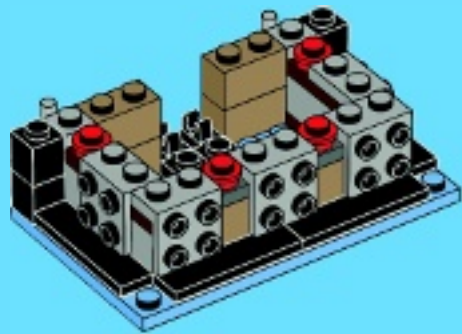



2x



4x

# 7

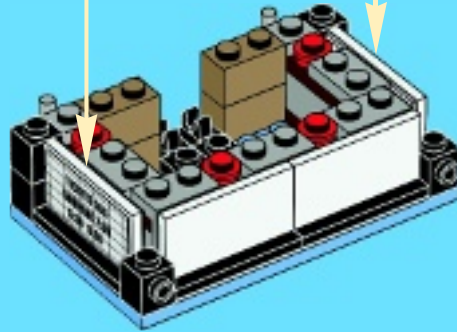
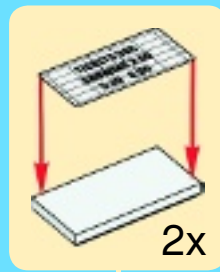

2x

# 8

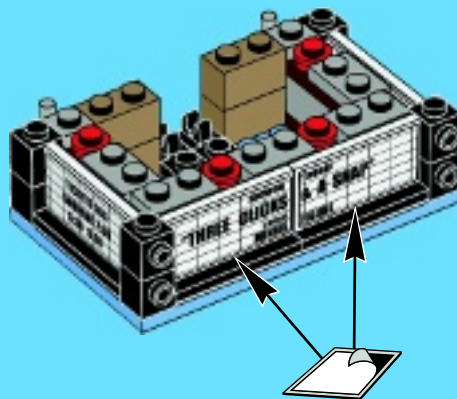

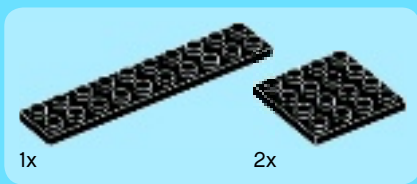

9

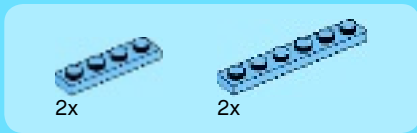
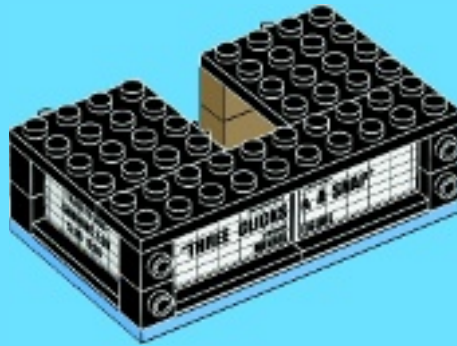

10

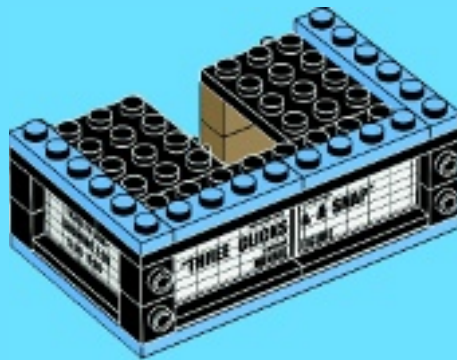



2x



14x

# 11

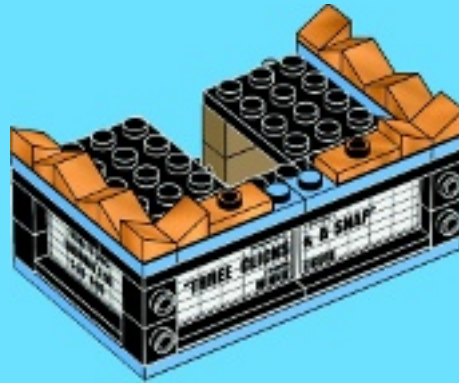

2x



1x



1x



2x



1x

# 12

1

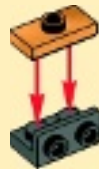

2

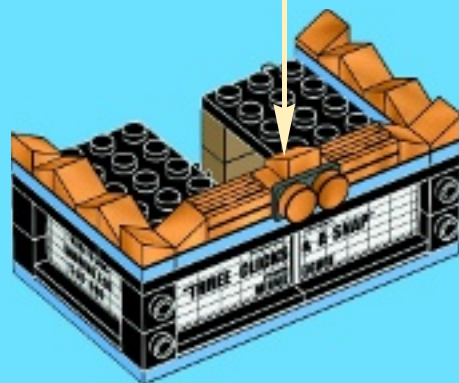

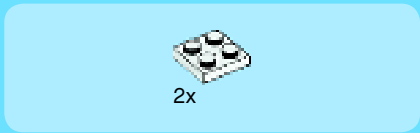
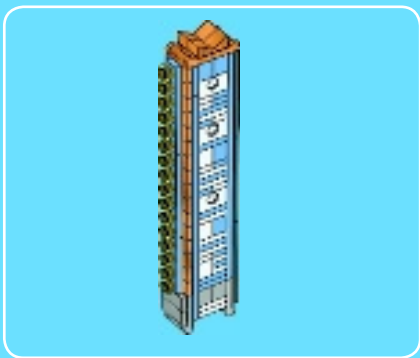

1

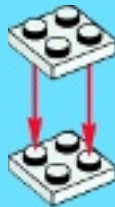

2

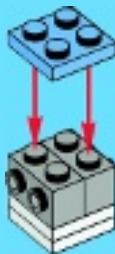

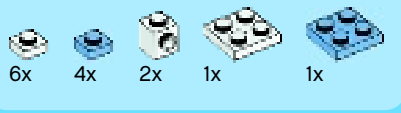

# 3

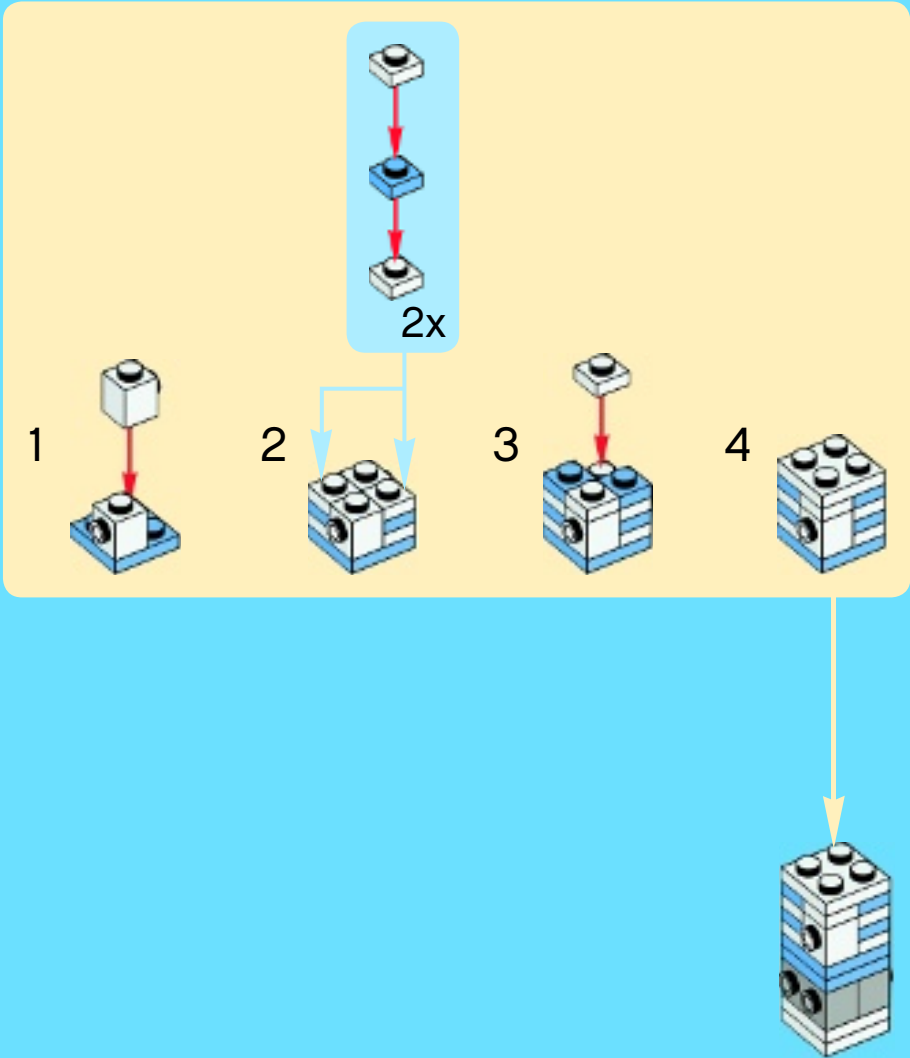



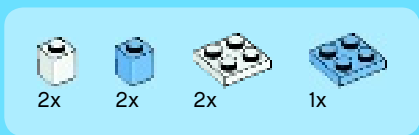

4

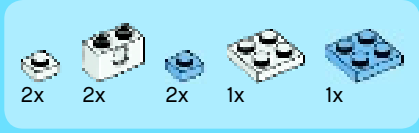

5

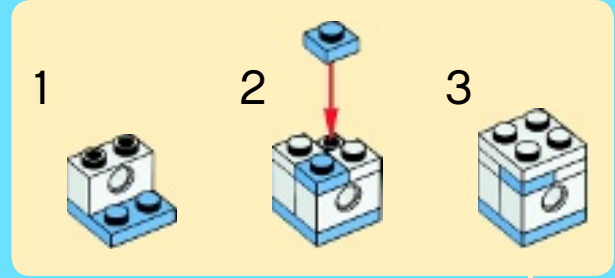



1x



2x



2x



1x



2x



2x

# 6

1

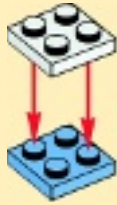

2



3



2x



2x



2x



1x



1x

# 7

1



2

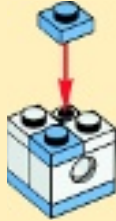

3



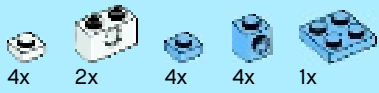

8

1



2



3

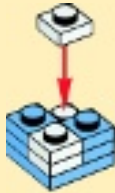

4

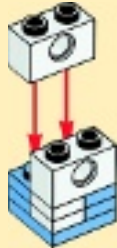

5

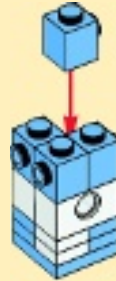



2x

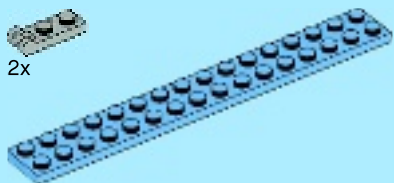

1x

9

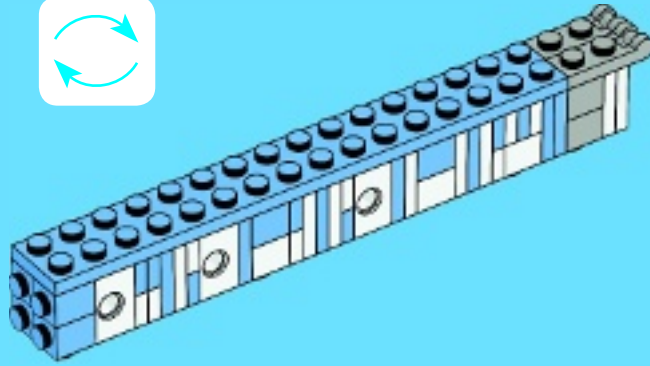

6x

10

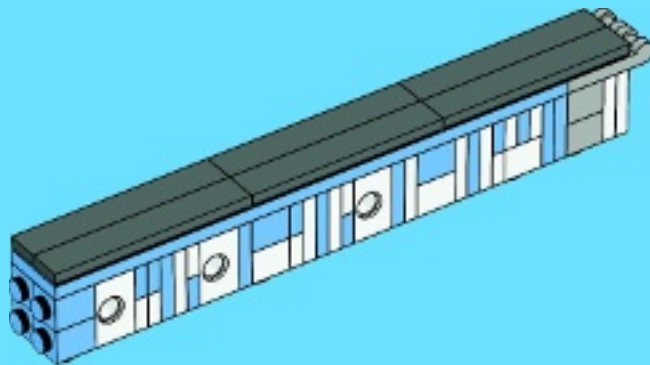

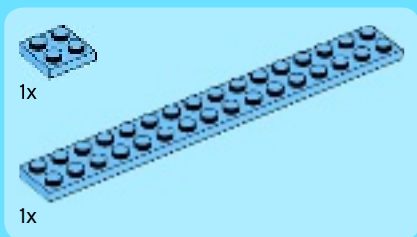

11

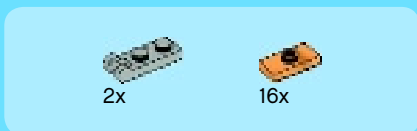
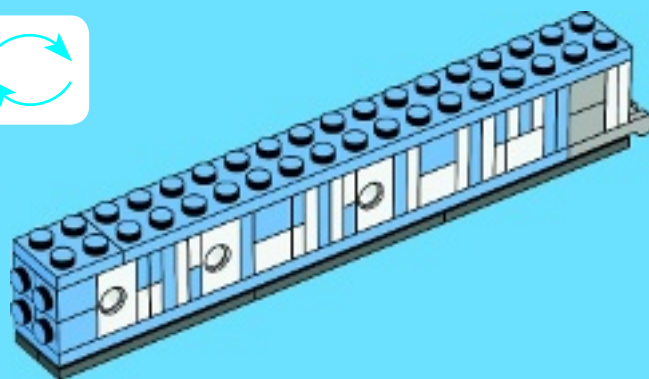

12

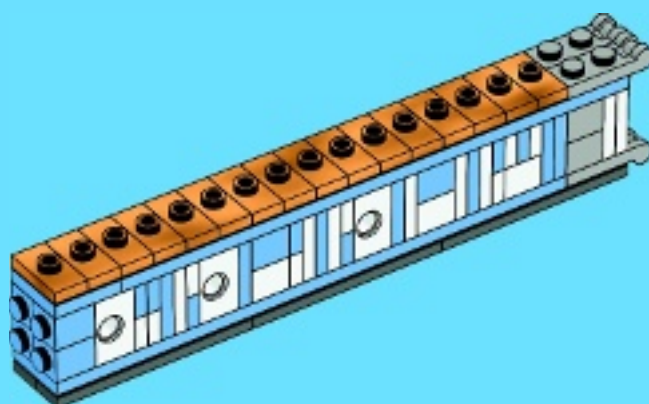



2x



2x



1x



2x

# 13

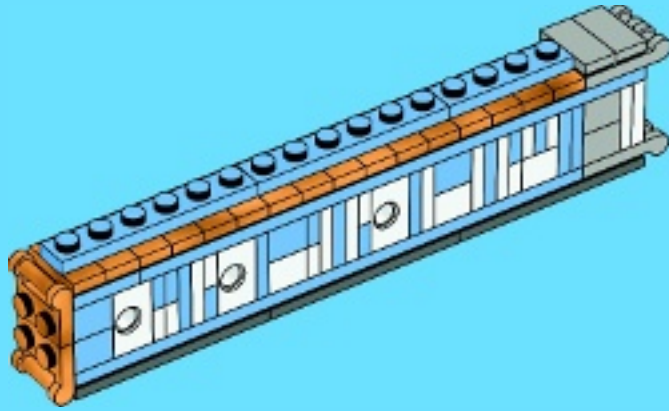

16x



4x

# 14

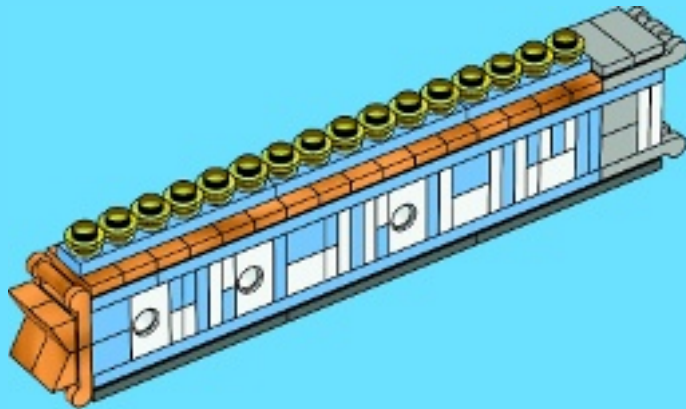

15

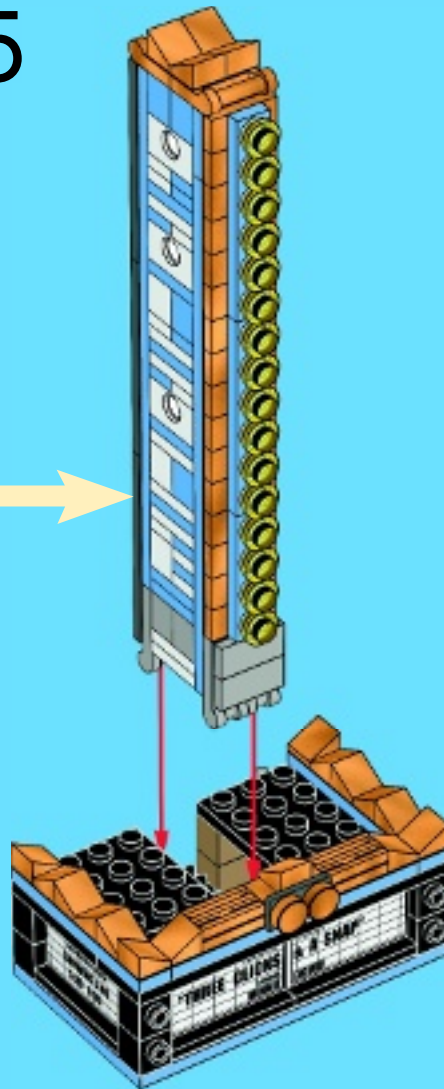

  
24x

# 16

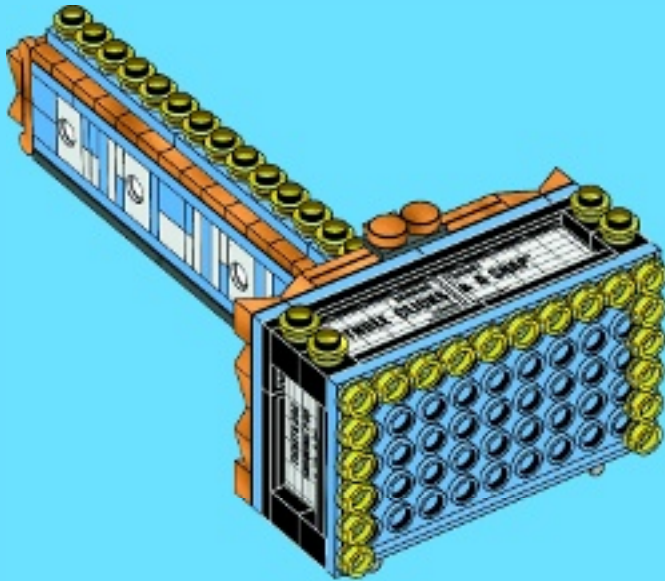



17





2x



4x



4x

# 18

1



2



2x





# 19

1

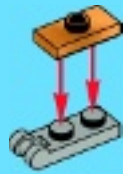

2

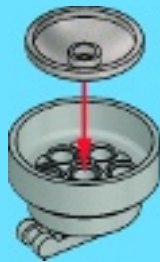

3

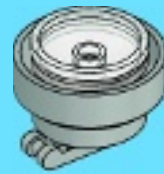

4

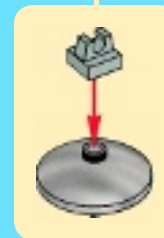

2x

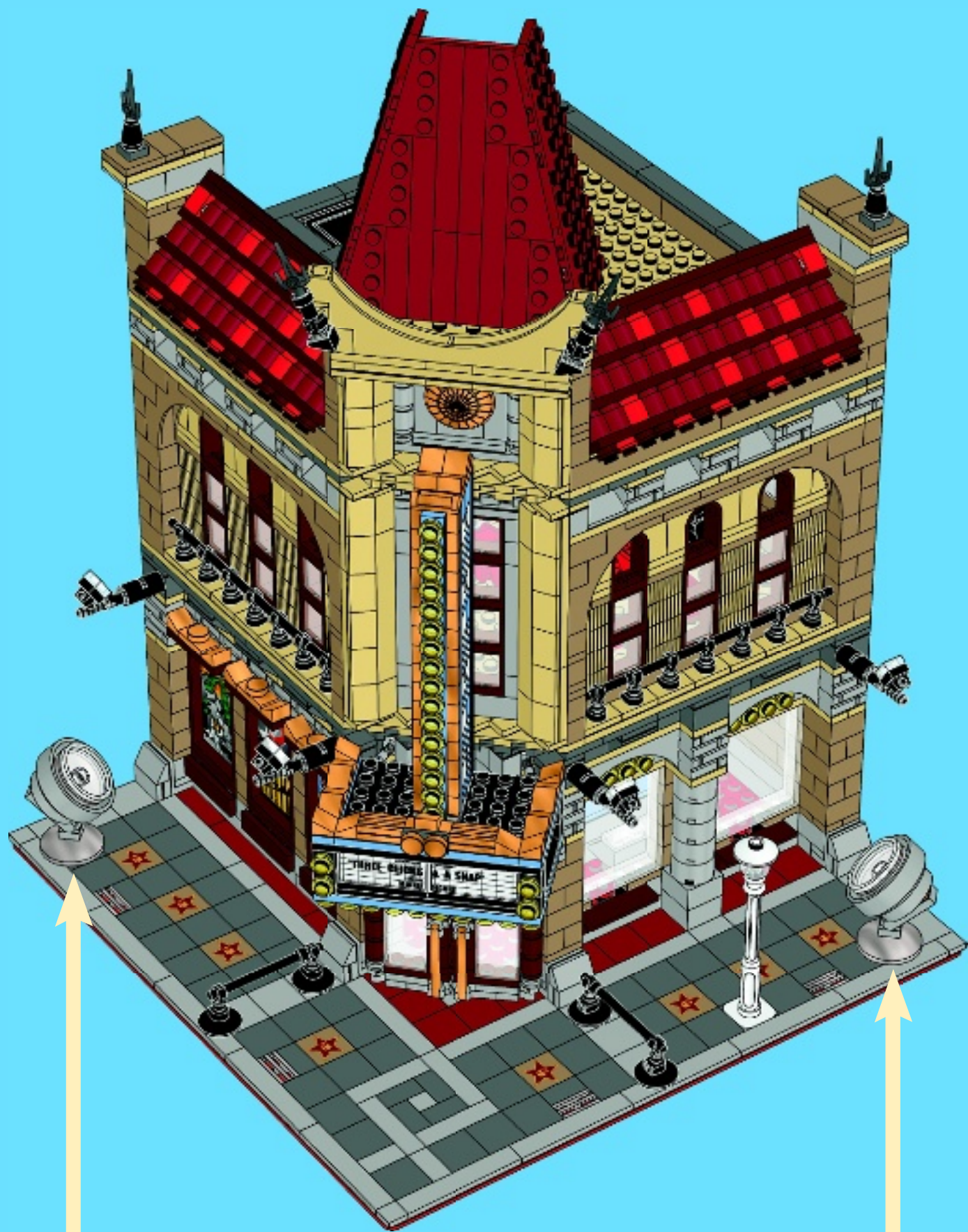



- 2x 300501
- 4x 4558952
- 6x 370001
- 16x 302401
- 8x 302201
- 1x 4527977
- 4x 4560178
- 8x 614101
- 1x 474001
- 1x 459901
- 1x 6014274
- 1x 9327
- 1x 9551
- 6x 4113915
- 4x 4109995
- 4x 4113916
- 6x 4118793
- 4x 4579260

- 32x 4655900
- 4x 4516055
- 16x 4624086
- 2x 4121972
- 2x 4579306
- 6x 6031057
- 1x 4568718
- 10x 4159553
- 14x 4155708
- 29x 4113917
- 2x 4114077
- 6x 4114084
- 14x 4121921
- 5x 4118790
- 4x 4113233
- 10x 4114309
- 10x 4124067
- 2x 4114324
- 13x 4143409

- 11x 4125253
- 30x 4114026
- 10x 4550324
- 6x 4157277
- 9x 4544139
- 9x 4208072
- 3x 4626948
- 1x 4540107
- 2x 4114001
- 11x 4113988
- 1x 4624223
- 2x 4609726
- 2x 4611414

- 2x 4624313
- 3x 3006840
- 1x 4113949
- 4x 3000840
- 3x 4650498
- 1x 3005740
- 2x 4186513
- 20x 6024020
- 4x 4113106
- 3x 4639698
- 2x 4504229
- 1x 4219773
- 2x 3001140
- 4x 3005741
- 48x 3005744

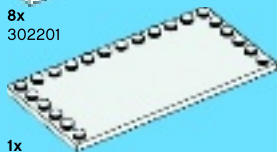

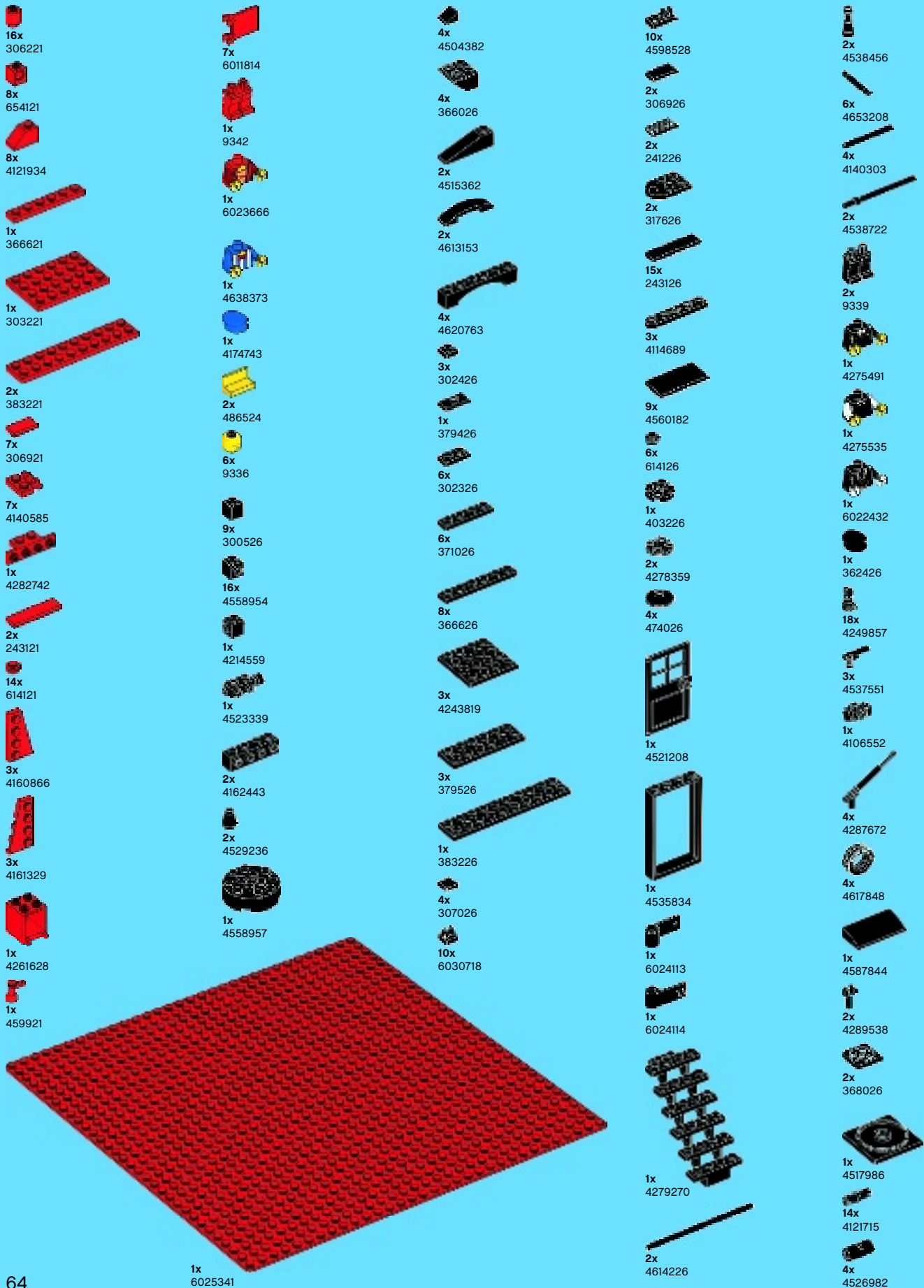

16x  
306221

8x  
654121

8x  
4121934

1x  
366621

1x  
303221

2x  
383221

7x  
306921

7x  
4140585

1x  
4282742

2x  
243121

14x  
614121

3x  
4160866

3x  
4161329

1x  
4261628

1x  
459921

7x  
6011814

1x  
9342

1x  
6023666

1x  
4638373

1x  
4174743

2x  
486524

6x  
9336

9x  
300526

16x  
4558954

1x  
4214559

1x  
4523339

2x  
4162443

2x  
4529236

1x  
4558957

4x  
4504382

4x  
366026

2x  
4515362

2x  
4613153

4x  
4620763

3x  
302426

1x  
379426

6x  
302326

6x  
371026

8x  
366626

3x  
4243819

3x  
379526

1x  
383226

4x  
307026

10x  
6030718

10x  
4598528

2x  
306926

2x  
241226

2x  
317626

15x  
243126

3x  
4114689

9x  
4560182

6x  
614126

1x  
403226

2x  
4278359

4x  
474026

1x  
4521208

1x  
4535834

1x  
6024113

1x  
6024114

1x  
4279270

2x  
4614226

2x  
4538456

6x  
4653208

4x  
4140303

2x  
4538722

2x  
9339

1x  
4275491

1x  
4275535

1x  
6022432

1x  
362426

18x  
4249857

3x  
4537551

1x  
4106552

4x  
4287672

4x  
4617848

1x  
4587844

2x  
4289538

2x  
368026

1x  
4517986

14x  
4121715

4x  
4526982



2x  
4295260



2x  
4114348

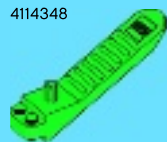

1x  
6000102



2x  
4179830



6x  
4649756



19x  
4179826



5x  
4179825



8x  
4653540



3x  
4179828



8x  
4179829

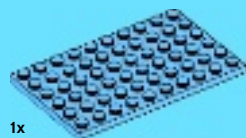

1x  
6024125

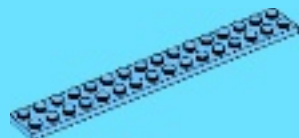

2x  
6024127



3x  
4168345



3x  
4597999



3x  
4567339



3x  
4183133

49x  
6001824



69x  
4521914



17x  
4255416



23x  
4247151



69x  
6024124



2x  
6000852

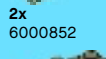

4x  
6024122

16x  
4549436

37x  
4528604

2x  
4578032

12x  
4626904

6x  
6015424

3x  
4550329

2x  
4496699

8x  
6023265

2x  
4507045

3x  
6005897

64x  
4539099



2x  
6009130

11x  
4539105

3x  
4583299

4x  
4539060

5x  
4539083

3x  
6008593

3x  
6008595

1x  
6009137

1x  
6009148

8x  
4211242

16x  
4529242

13x  
4211183

4x  
4211252

4x  
4211221

7x  
4221744

4x  
4211257

6x  
4211152

22x  
4211190

3x  
4211186

1x  
4216945

10x  
4223683

3x  
4211288

4x  
4211151

17x  
4211194

2x  
4211204

22x  
4216581

7x  
4211159

6x  
4542131

20x  
4595814

2x  
4565214

6x  
4623513

1x  
4623429

3x  
4623513

1x  
4623429

1x  
4550736



1x  
4277751

4x  
4517996

1x  
4490082

1x  
6024067

31x  
4587002

24x  
4523157

5x  
4490599

2x  
4585493

7x  
4649422

2x  
4600267

1x  
4649896

4x  
4249040

4x  
4296514

1x  
4529672

1x  
4659399

1x  
6005435

5x  
4655241

4x  
4646870

- 3x 4211362
- 29x 4211389
- 19x 4211388
- 1x 4211363
- 3x 4211387
- 5x 4211349
- 6x 4211428
- 2x 4211386
- 11x 4211394
- 15x 4211393
- 19x 4211521
- 4x 4225532
- 33x 6000066
- 4x 4211636
- 18x 4211412
- 5x 4211526
- 8x 4211718
- 14x 4568637
- 2x 4622060
- 2x 4211436
- 2x 4221589
- 4x 4632575
- 4x 4211399
- 20x 4211398
- 3x 4211397
- 2x 4211429
- 5x 4211396
- 5x 4211438
- 1x 4211404
- 2x 4211407
- 1x 4211486









- 9x 4211415
- 2x 6030711
- 12x 4594238
- 19x 4211414
- 10x 6015344
- 9x 6009014
- 4x 4654580
- 1x 4654582
- 2x 4211568
- 12x 4211413
- 2x 4654577
- 12x 4515369
- 9x 4211356
- 17x 4211549
- 7x 4211525
- 1x 4211352
- 2x 4211520
- 2x 4538098
- 2x 4529120
- 2x 4211701
- 2x 4511007



- 6x 4211644
- 2x 4540203
- 2x 4211573
- 4x 4211758
- 7x 4211088
- 5x 4211104
- 4x 4211100
- 2x 4211107
- 2x 4211095
- 1x 4529240
- 2x 4624186
- 4x 4210639
- 2x 4211135
- 1x 4211054
- 6x 4211000
- 2x 4211127
- 4x 4210719
- 16x 4211063
- 1x 4211133
- 6x 4211001
- 3x 4598769

- 18x 4211056
- 6x 4211002
- 1x 4210998
- 1x 4211134
- 3x 4257526
- 7x 4211067
- 3x 4210848
- 20x 4211052
- 2x 6000606
- 57x 4211055
- 2x 4521187
- 7x 4568734
- 1x 4217558
- 4x 4211053
- 25x 4210651
- 2x 4210897
- 1x 4210844
- 2x 4540386



Customer Service  
Kundenservice  
Service Consommateurs  
Servicio Al Consumidor  
LEGO.com/service or dial

00800 5346 5555 :         

1-800-422-5346 :  

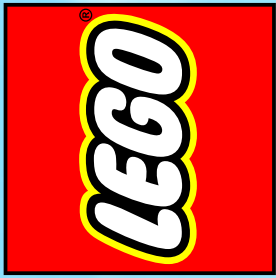

# CREATOR



EXPERT

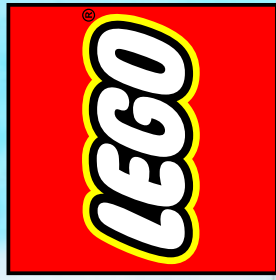

# CREATOR

10233



EXPERT

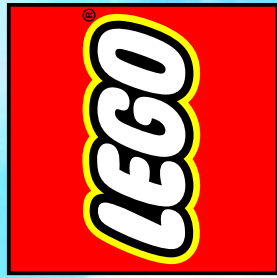

CREATOR

10226



EXPERT

1



club™

FREE\*! GRATIS! GRATUIT!

[www.LEGOclub.com/Max](http://www.LEGOclub.com/Max)

[www.LEGOclub.com/Max](http://www.LEGOclub.com/Max)

2



3



©2013 The LEGO Group.

\*Paid subscription in Australia and New Zealand.

\*Abonnement payant en Australie et Nouvelle-Zélande.

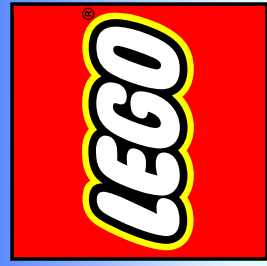

# VIP Program Programme VIP



Earn VIP Points every time you shop directly with us and enjoy valuable rewards

Gagnez des points VIP à chaque achat et profitez de Formidables avantages

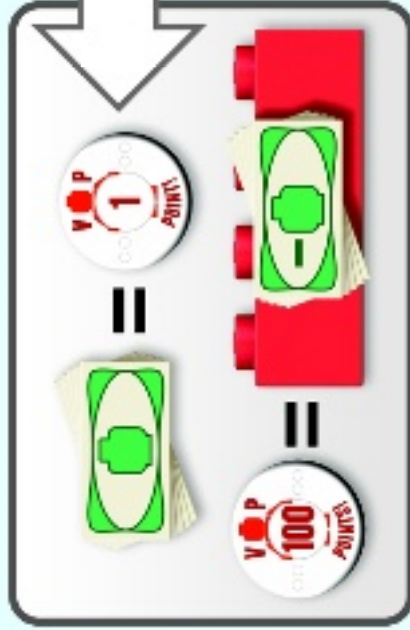

Earn 100 VIP Points and get a reward off your next purchase!

Gagnez 100 points VIP et bénéficiez d'une réduction sur votre prochain achat !



Access exclusive LEGO® sets just for VIPs  
Accédez aux ensembles LEGO® exclusifs réservés aux membres VIP



# VIP.LEGO.COM

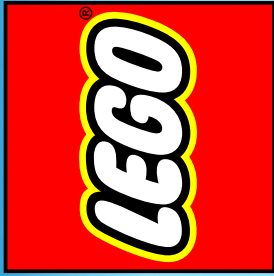

# CREATOR

## YOUR OPINION COUNTS! VOTRE OPINION NOUS INTÉRESSE !

Answer a few questions about your new LEGO® product and you could **win** a prize!  
Please visit:

[LEGOsurvey.com/product](http://LEGOsurvey.com/product)

No purchase necessary. Open to all residents where not prohibited.



### DEINE MEINUNG ZÄHLT!

Beantworte einige Fragen über unser neues LEGO® Produkt und gewinne mit etwas Glück einen Preis!  
Besuche uns auf:

[LEGOsurvey.com/product](http://LEGOsurvey.com/product)

Die Teilnahme ist nicht an einen Einkauf gebunden.  
Teilnahme in allen nicht ausgeschlossenen Ländern möglich.

### VOTRE OPINION NOUS INTÉRESSE !

Répondez à quelques questions sur notre nouveau produit LEGO® et vous gagnerez peut-être un prix !  
Rendez-vous sur :

[LEGOsurvey.com/product](http://LEGOsurvey.com/product)

Sans obligation d'achat.  
Ouvert à tous les résidents des pays autorisés.

### GEEF JE MENING!

Beantwoord een paar vragen over je nieuwe LEGO® product en maak kans op een prijs!  
Ga naar:

[LEGOsurvey.com/product](http://LEGOsurvey.com/product)

Geen koopverplichting.  
Deelname toegestaan waar geen enquêteverbod geldt.

みなさまのご意見をお聞かせください！  
レゴ®新製品について、いくつかの質問にお答えください。お答え頂いた方には抽選でプレゼントをお渡しします。  
以下のサイトをご覧ください：  
[LEGOsurvey.com/product](http://LEGOsurvey.com/product)

お買い上げ頂く必要はありません。  
どなたでもご利用いただけます。  
(法律で禁止されている国を除く)

# EXPERT

7 [LEGO.com](http://LEGO.com)