



ATLANTIS

7985



1

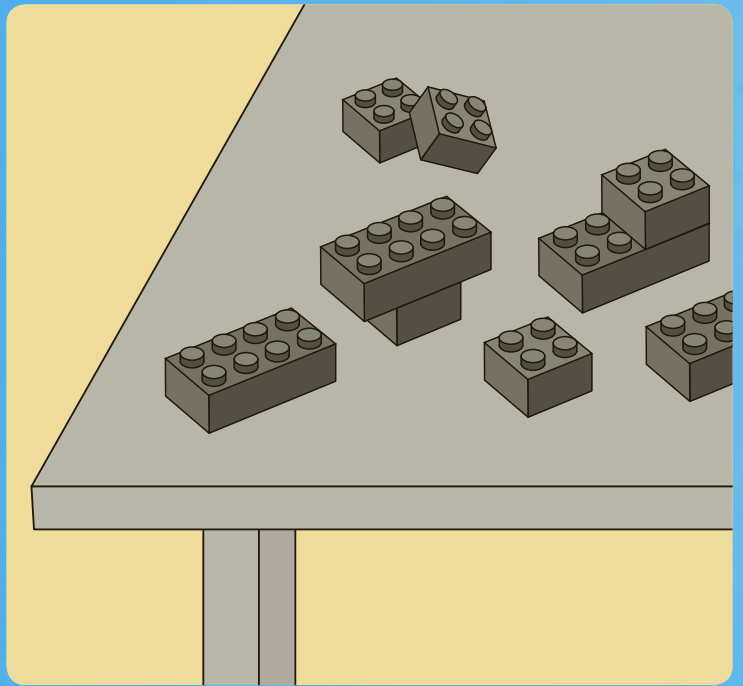
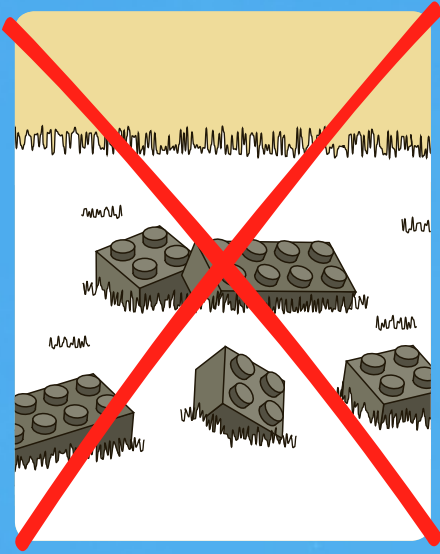

2



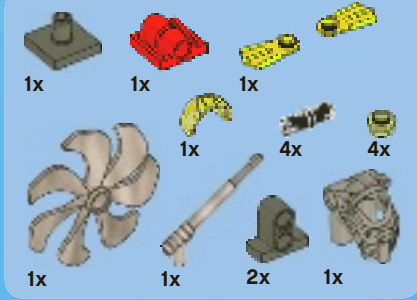

3



2

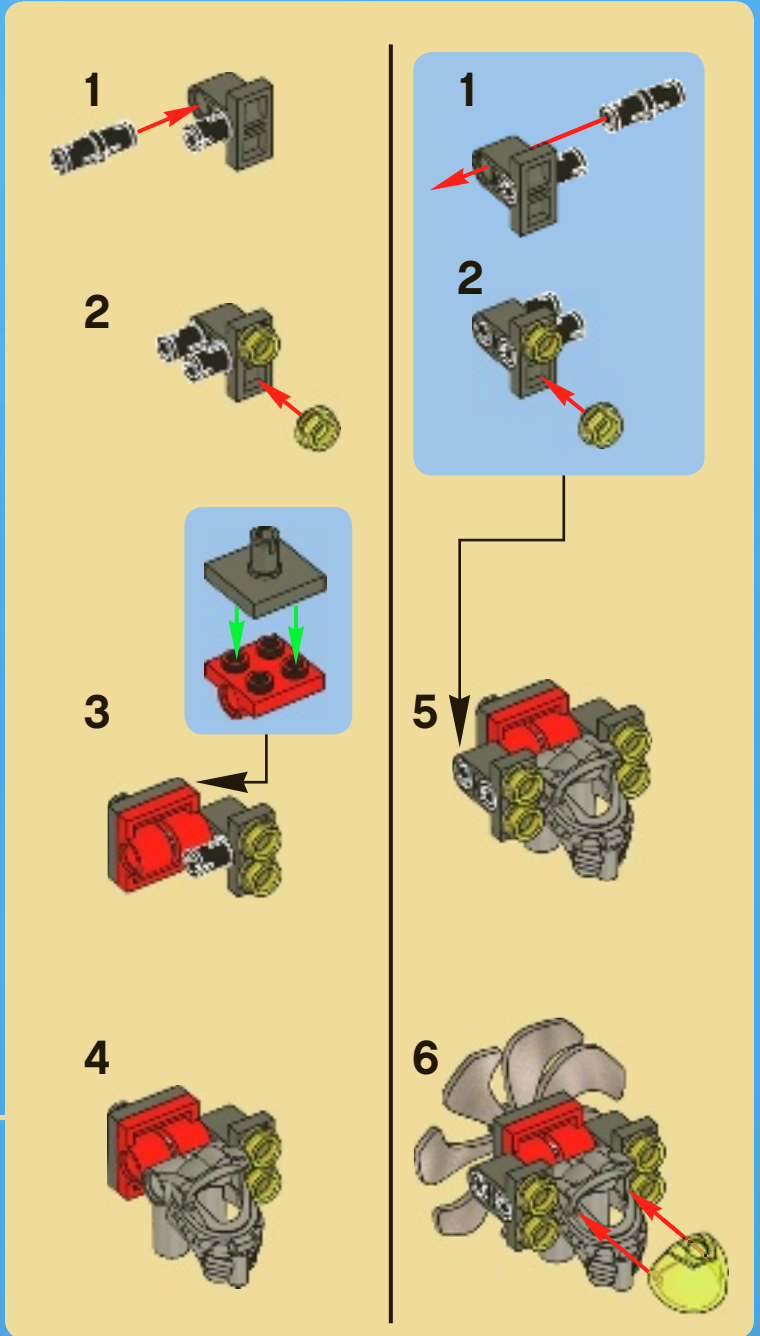



1

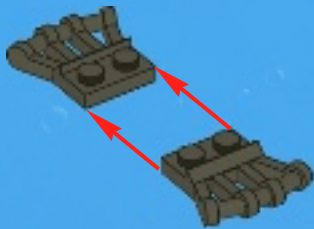

2



3





1x



2x

4



1x

5



1x

6



1x

7



2x

8



2x



2x

9

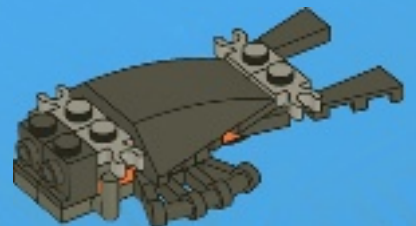



1x

10



11



1x

12

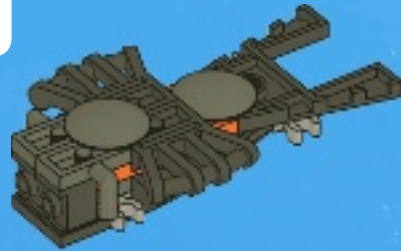



2x

13

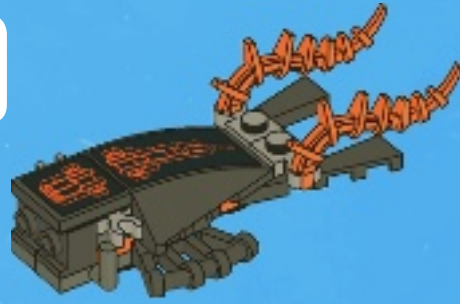

6x



6x

14

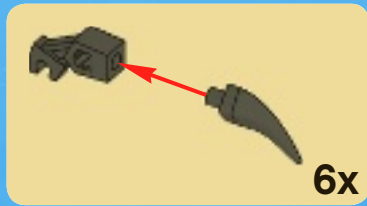

6x



2x



2x

15



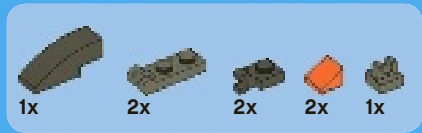

16

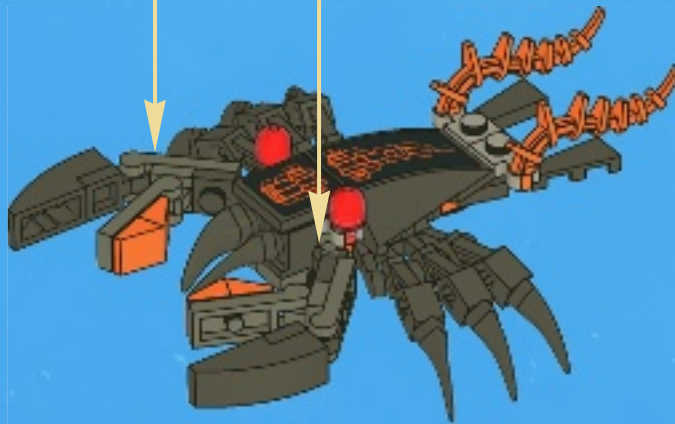
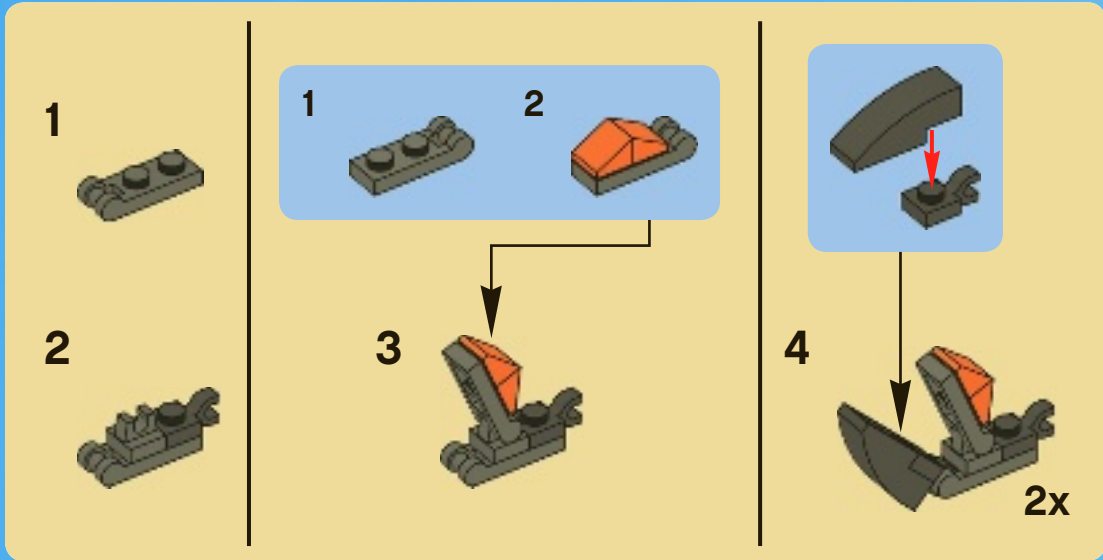



1x

1



2x



2x

2

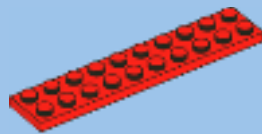

1x

3

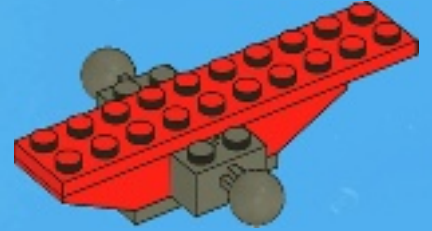

4x

4



1x



1x

5



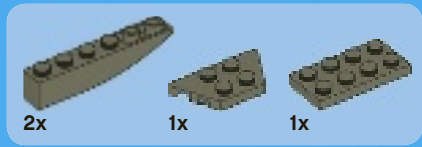

6

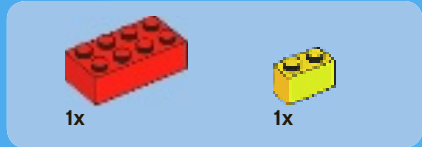
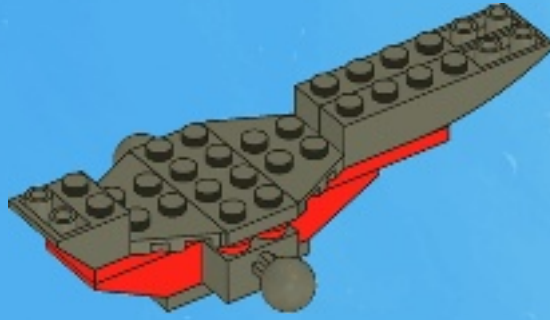

7

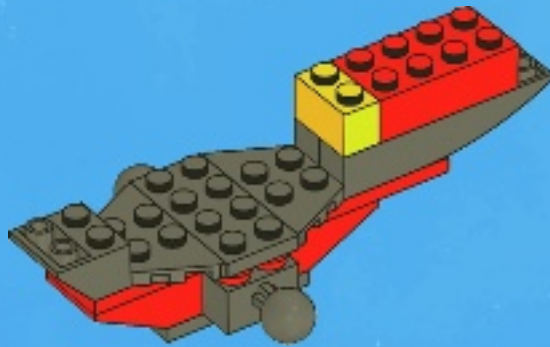

8

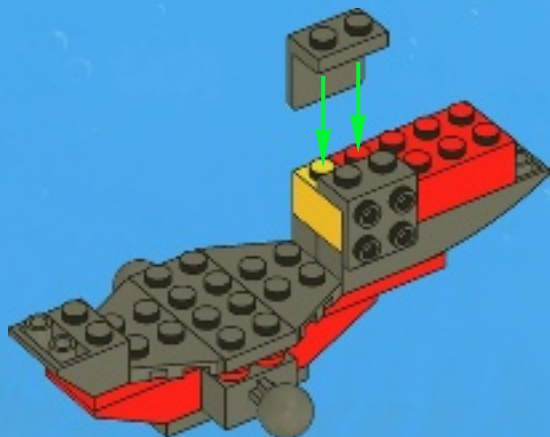



1x



2x

9

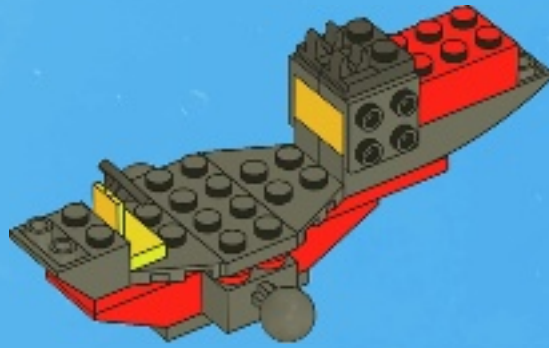

2x



2x

10

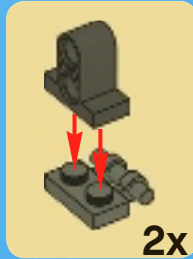

2x

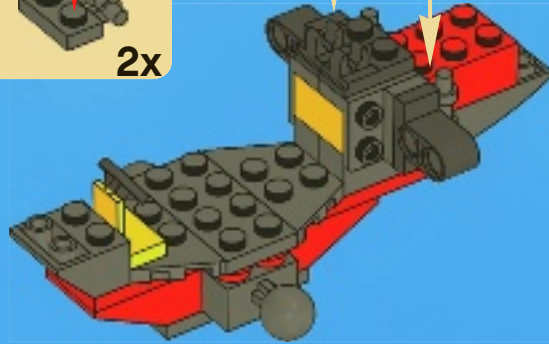

1x



2x



2x

11

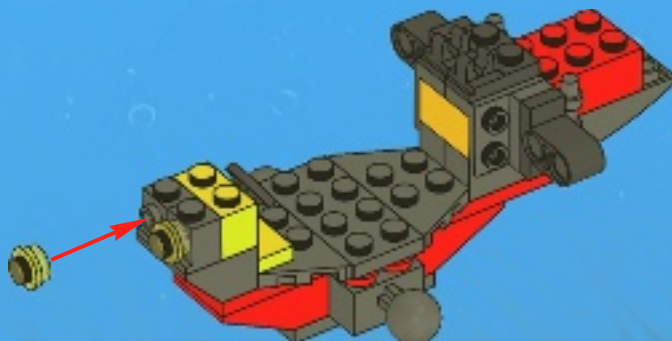



2x

12

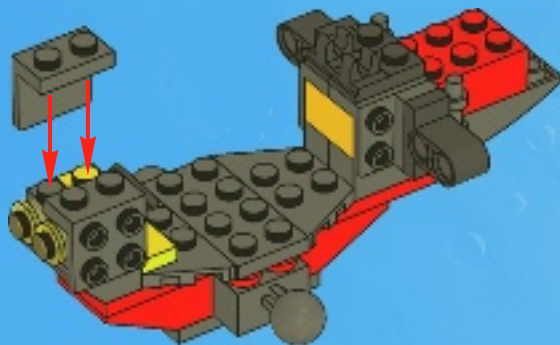

2x



4x



8x

13

1



2



3



2x

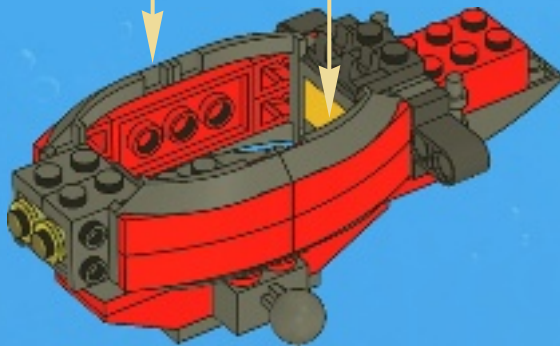



4x

14

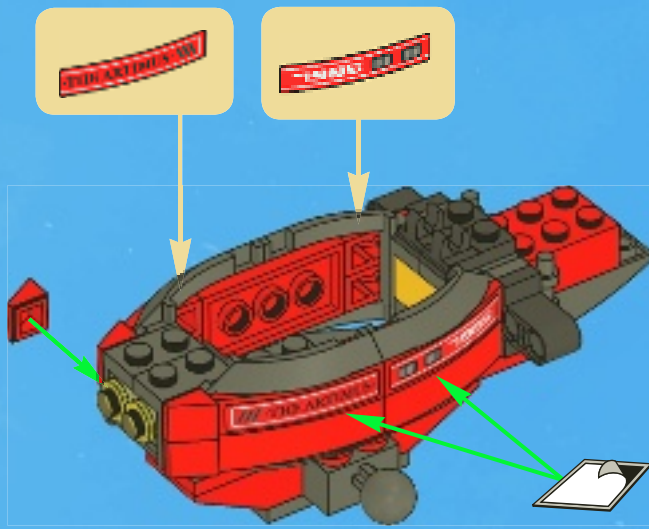

1x



1x

15

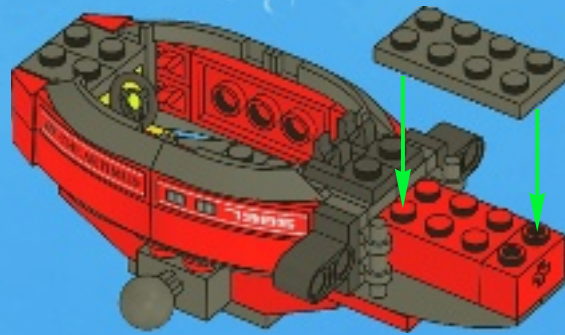

1x



1x

16

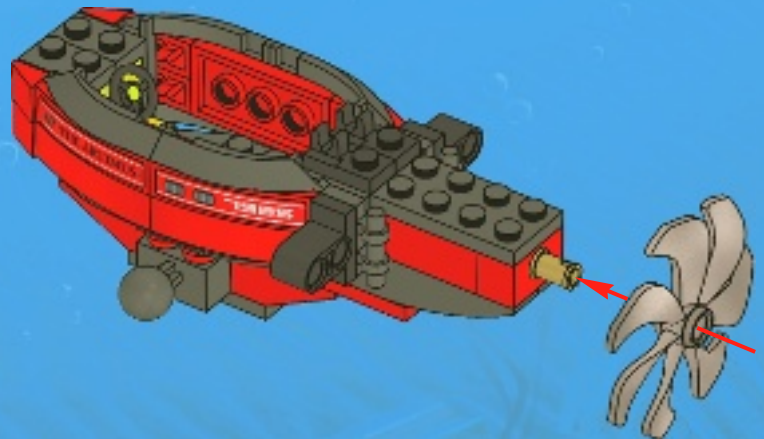

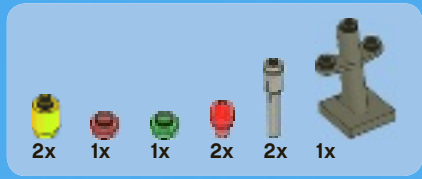

17

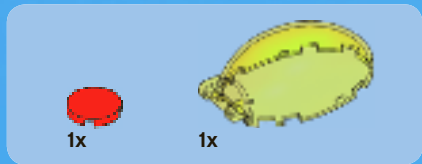
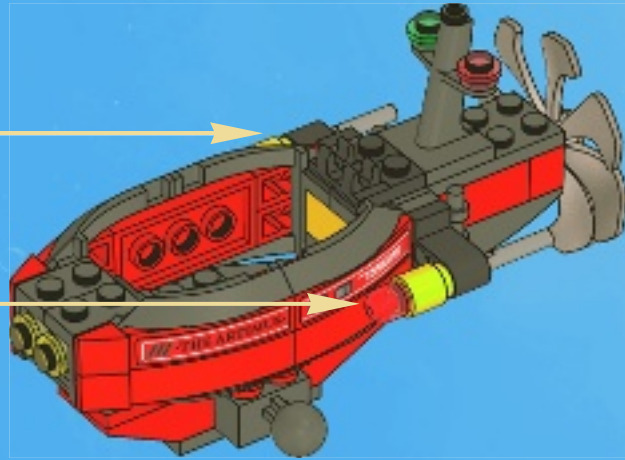
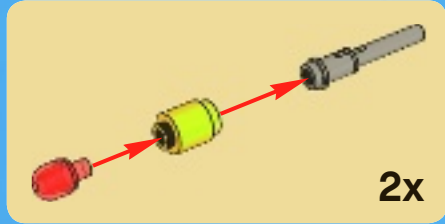
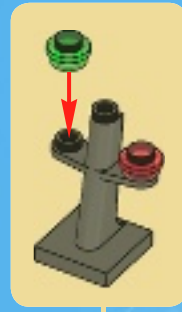

18

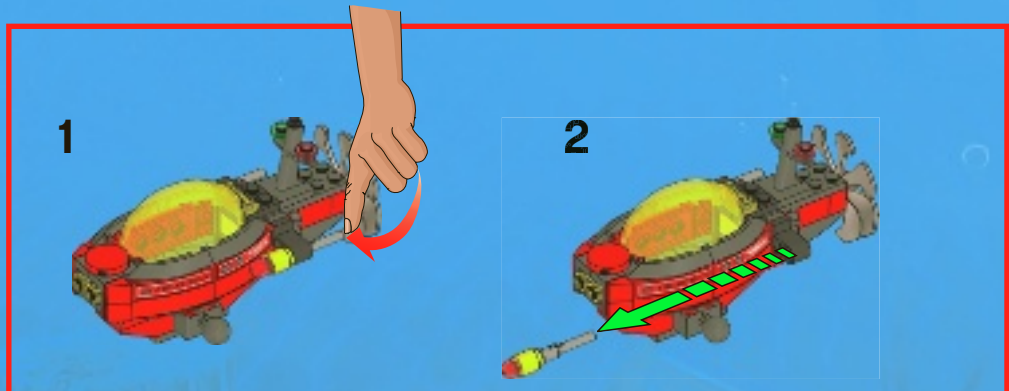
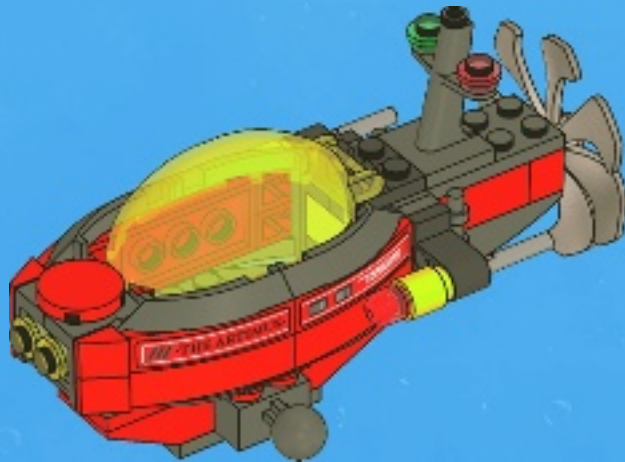



19

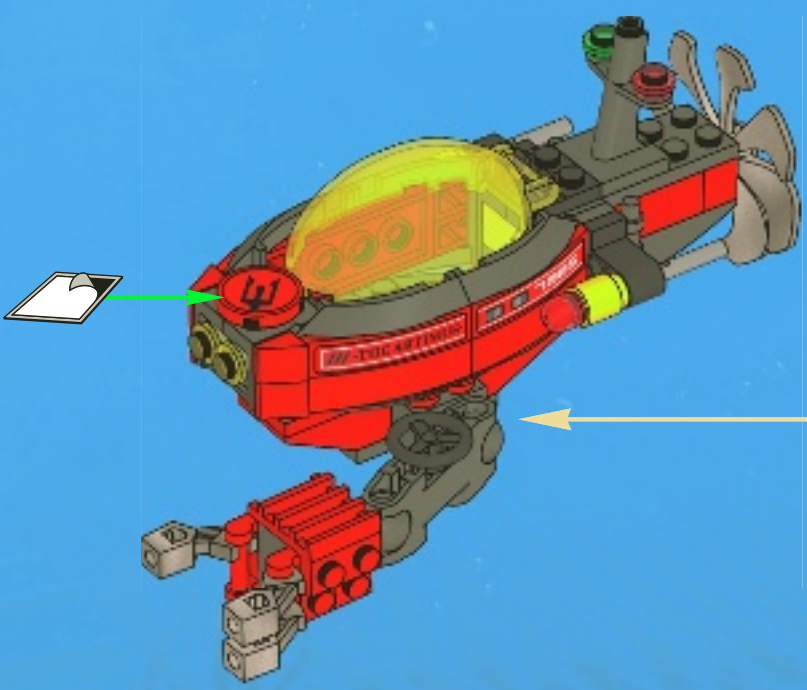
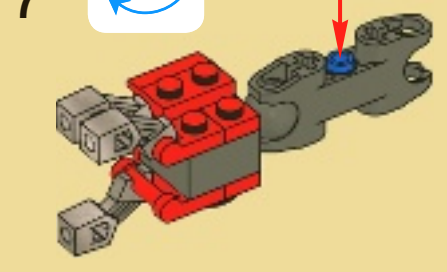
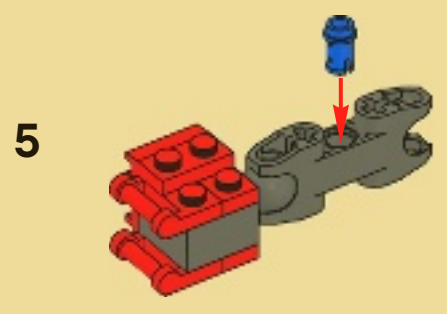
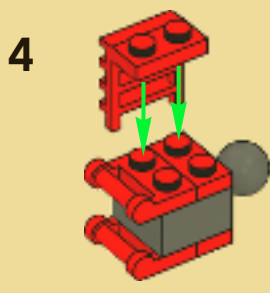
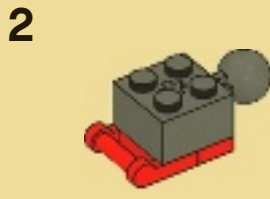
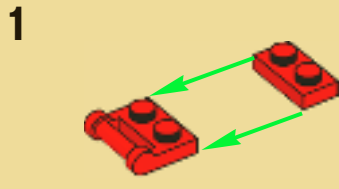

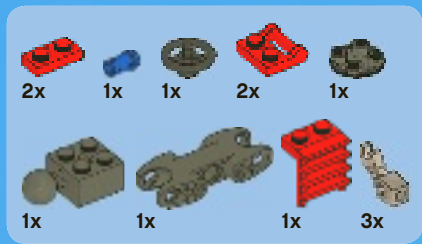

20

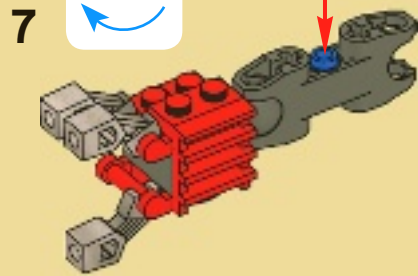
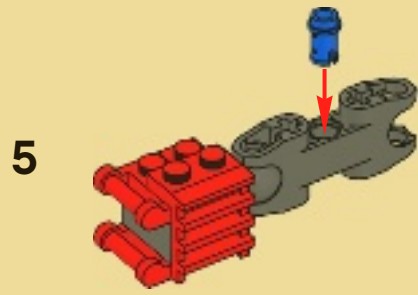
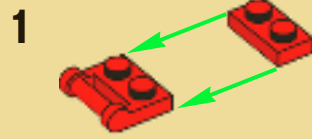

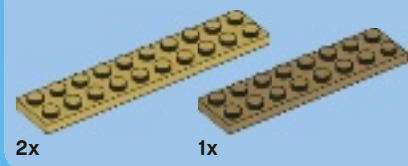
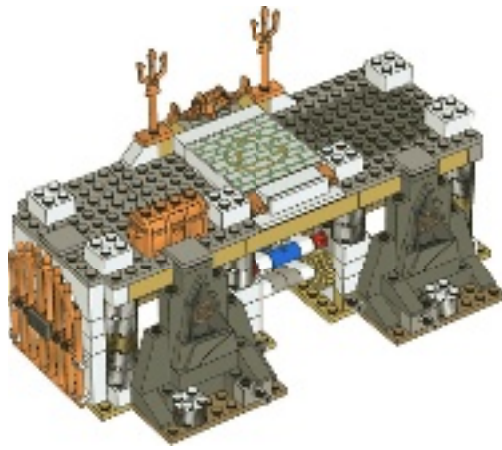

1

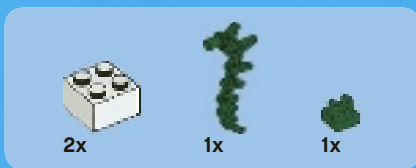
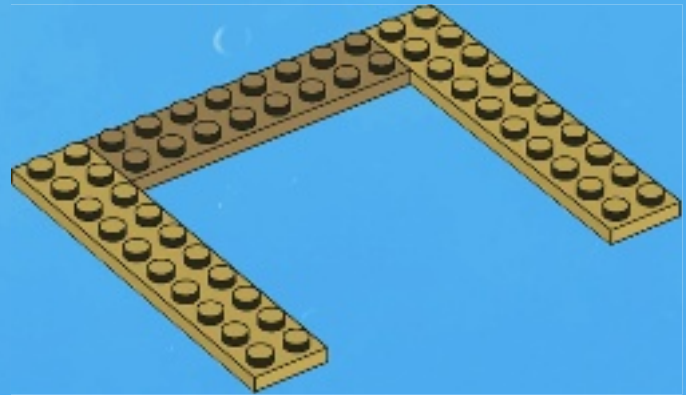

2

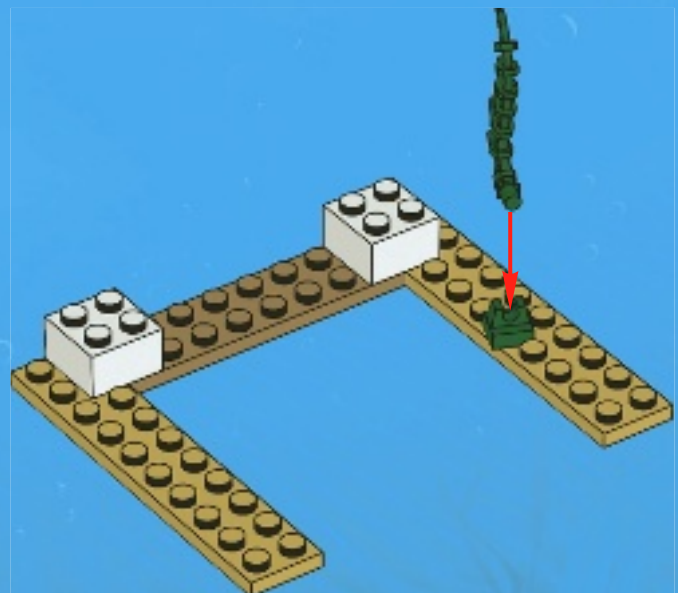

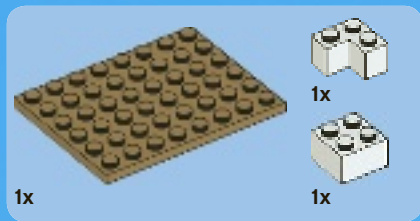

3

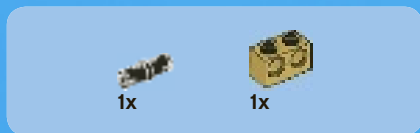

4





12x



3x

5

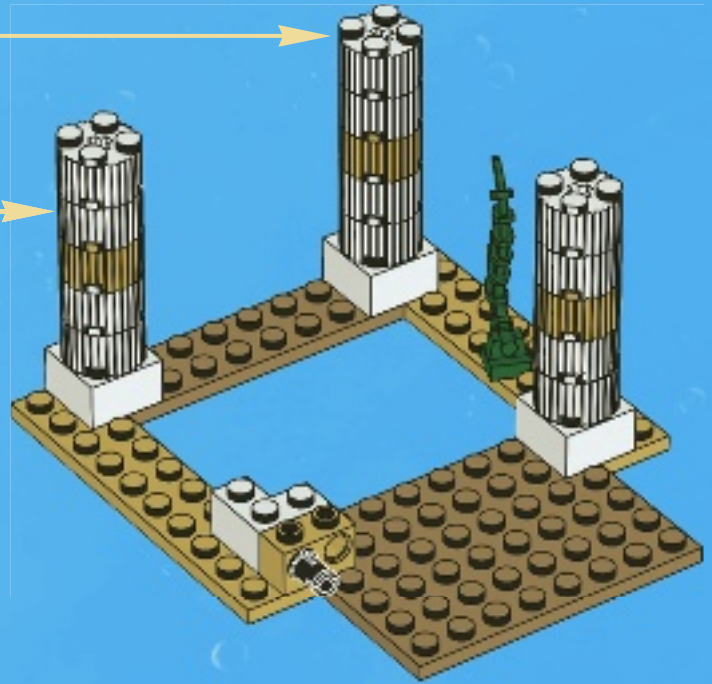
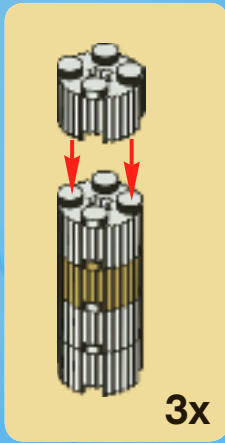

1x



1x



2x

6

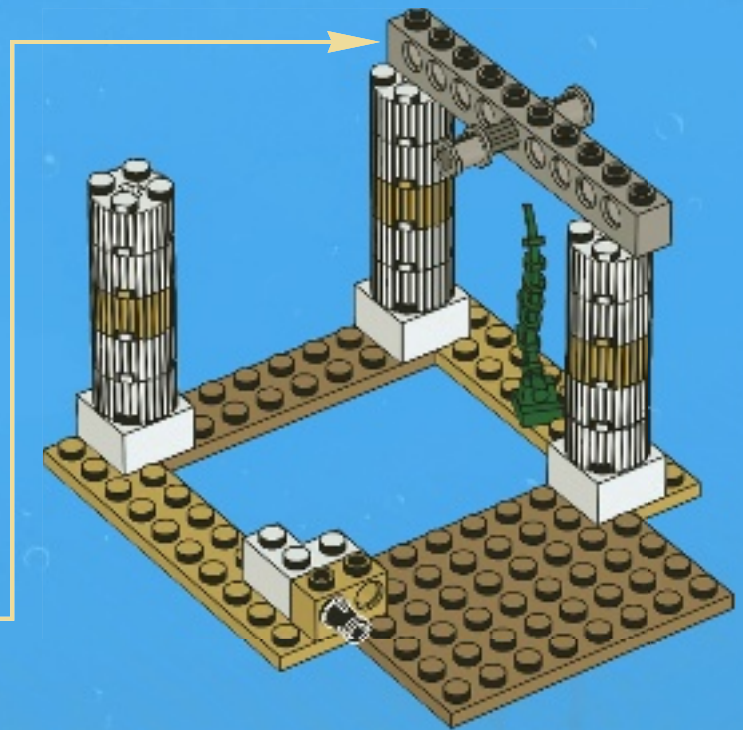
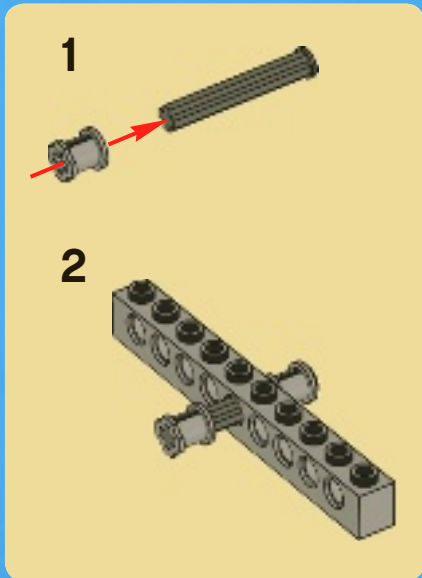

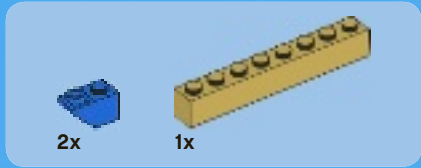

7

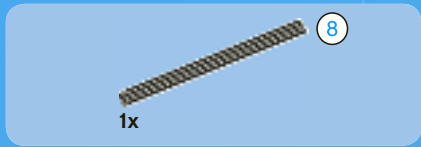
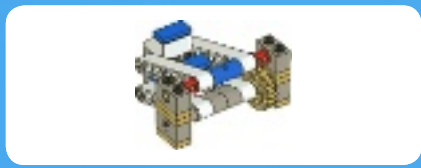

1





2x

2

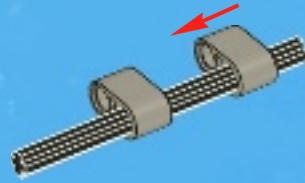

2x

3

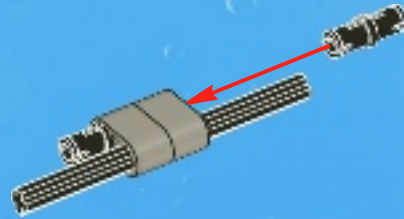

1x

4

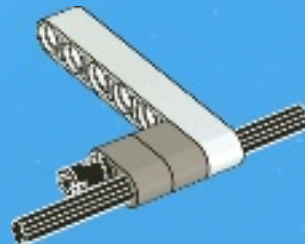

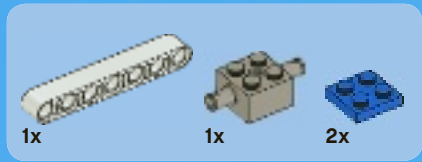

5

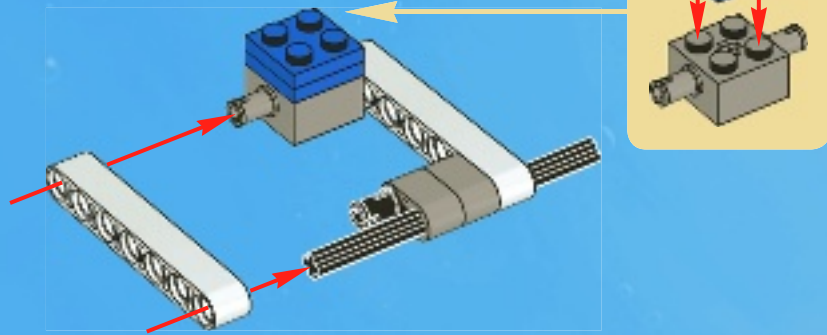

6

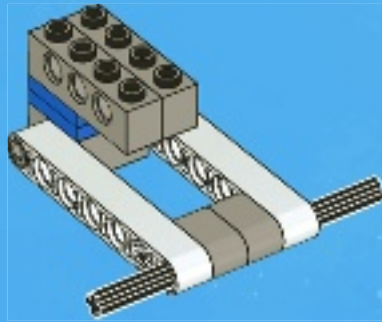

7

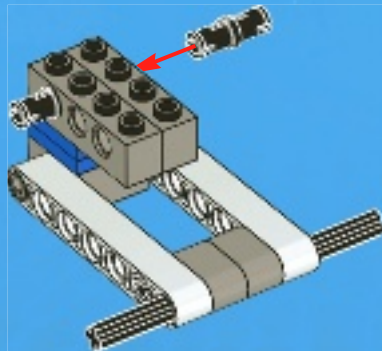



1x



2x

8

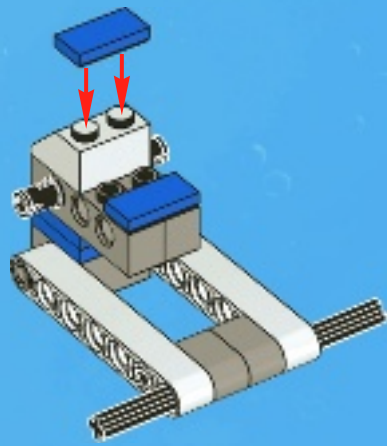

1x



1x

9

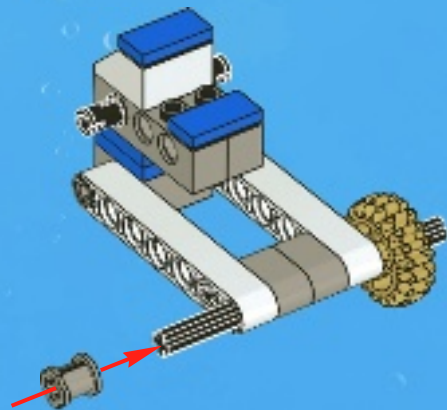

1x



1x



1x



1x

10

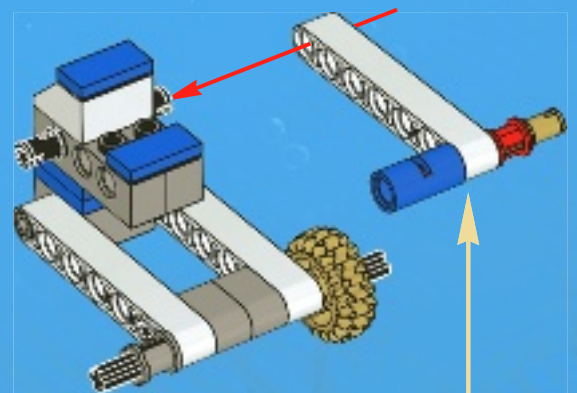
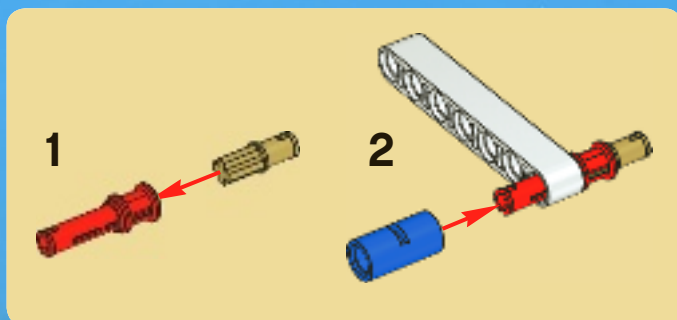

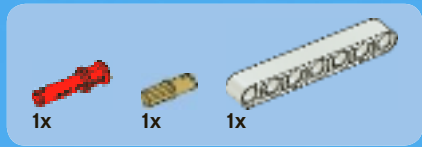

11

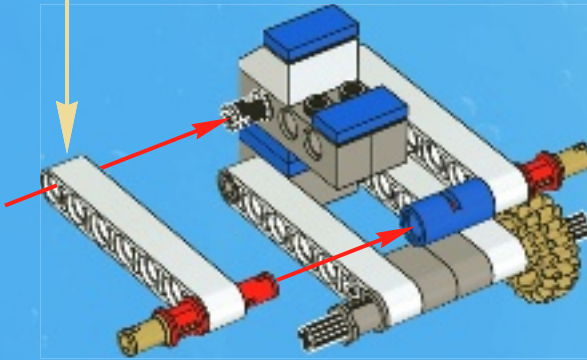
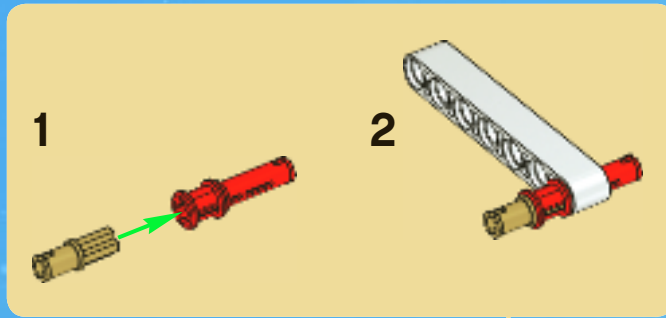

12

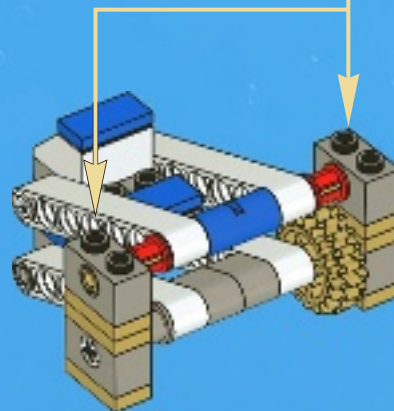
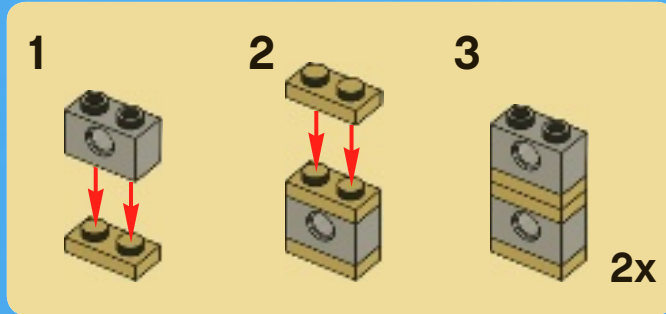

8

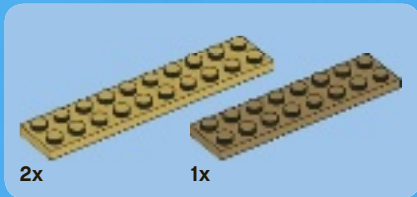
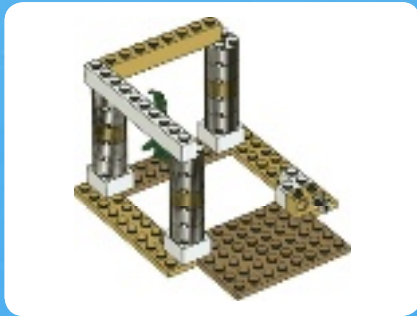

1

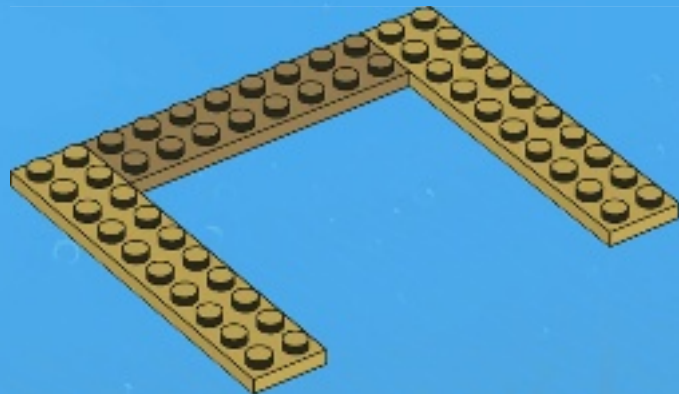



2

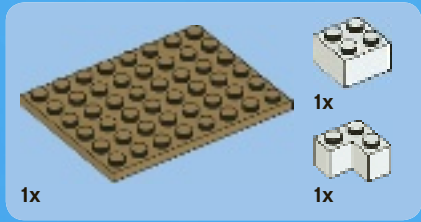
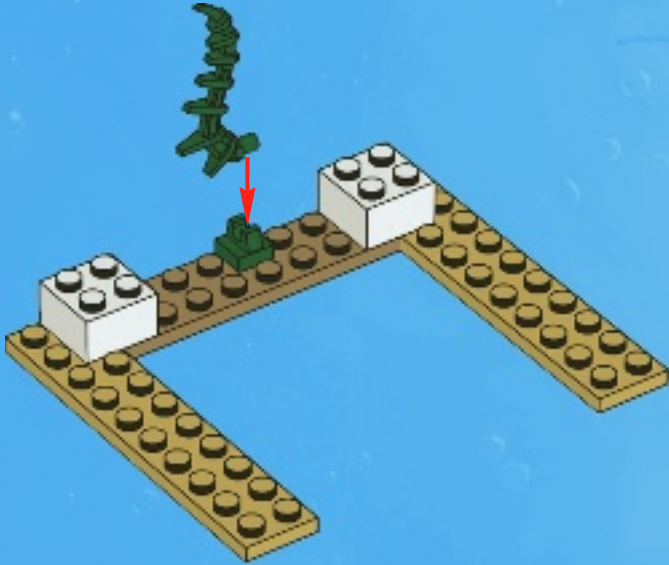

3





1x



1x

4

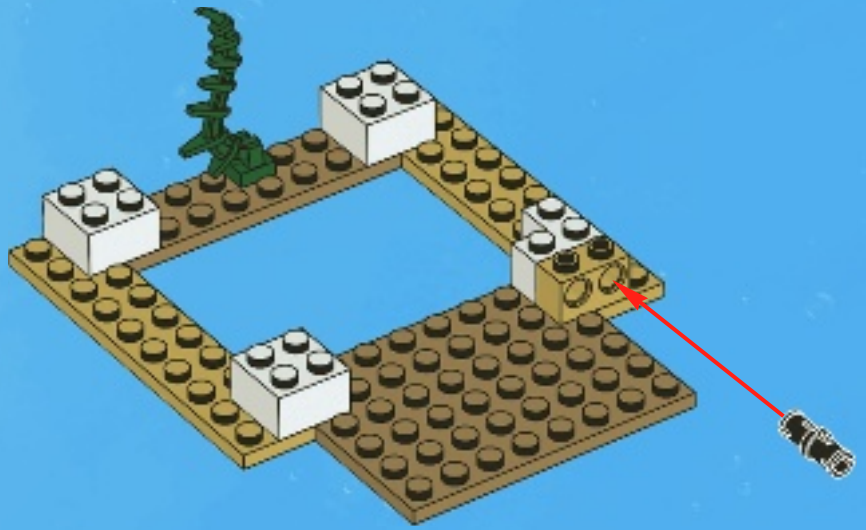

12x



3x

5

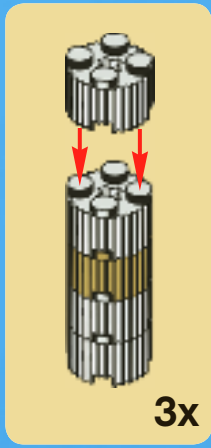

3x

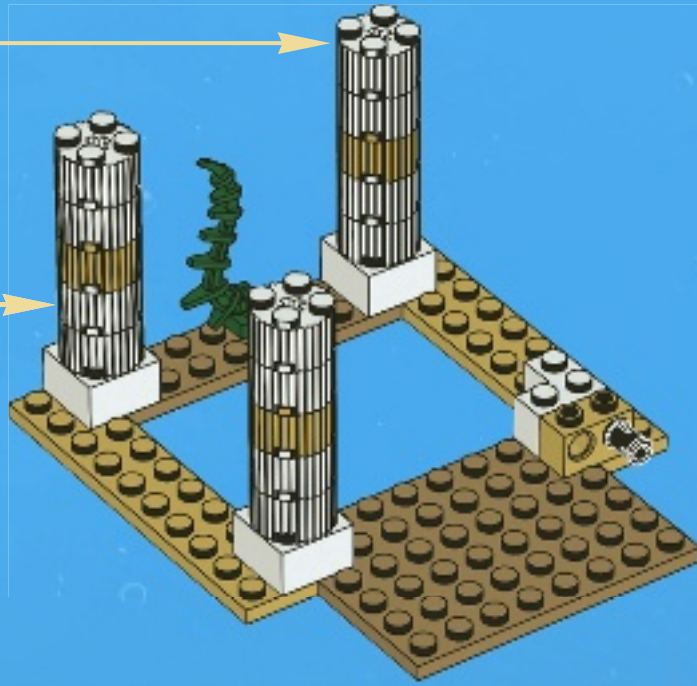

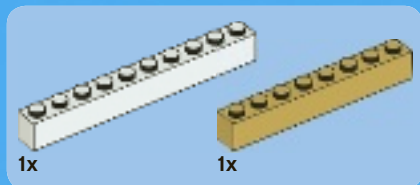

6

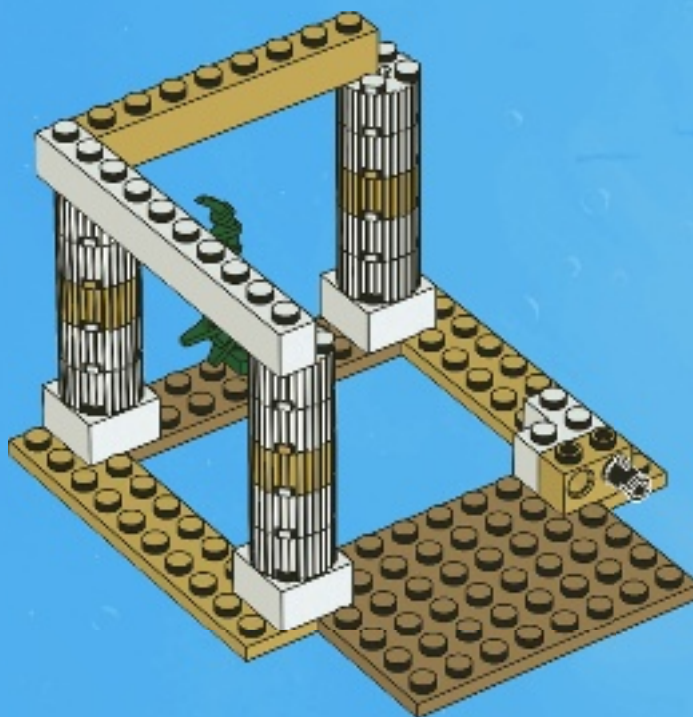

9

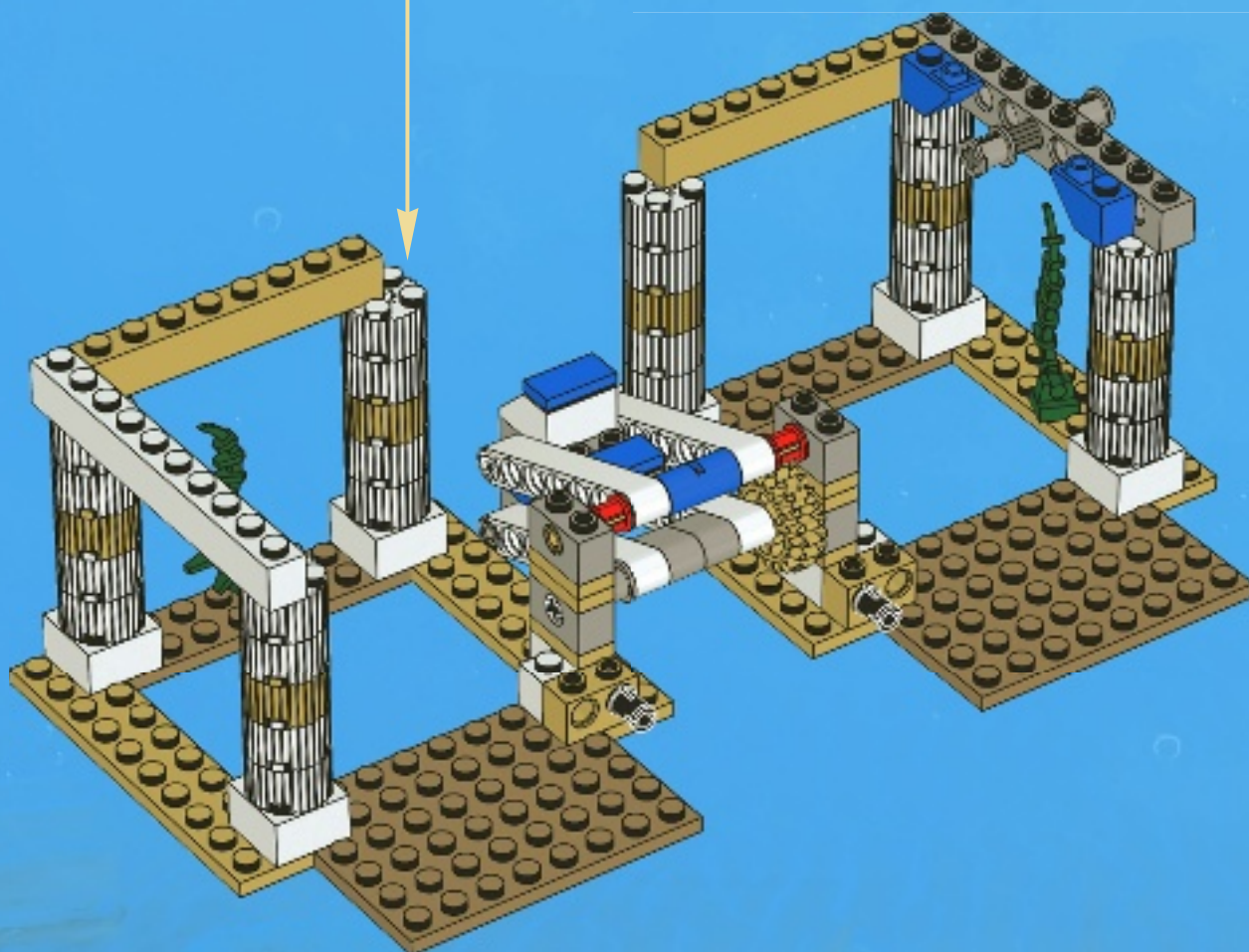



10

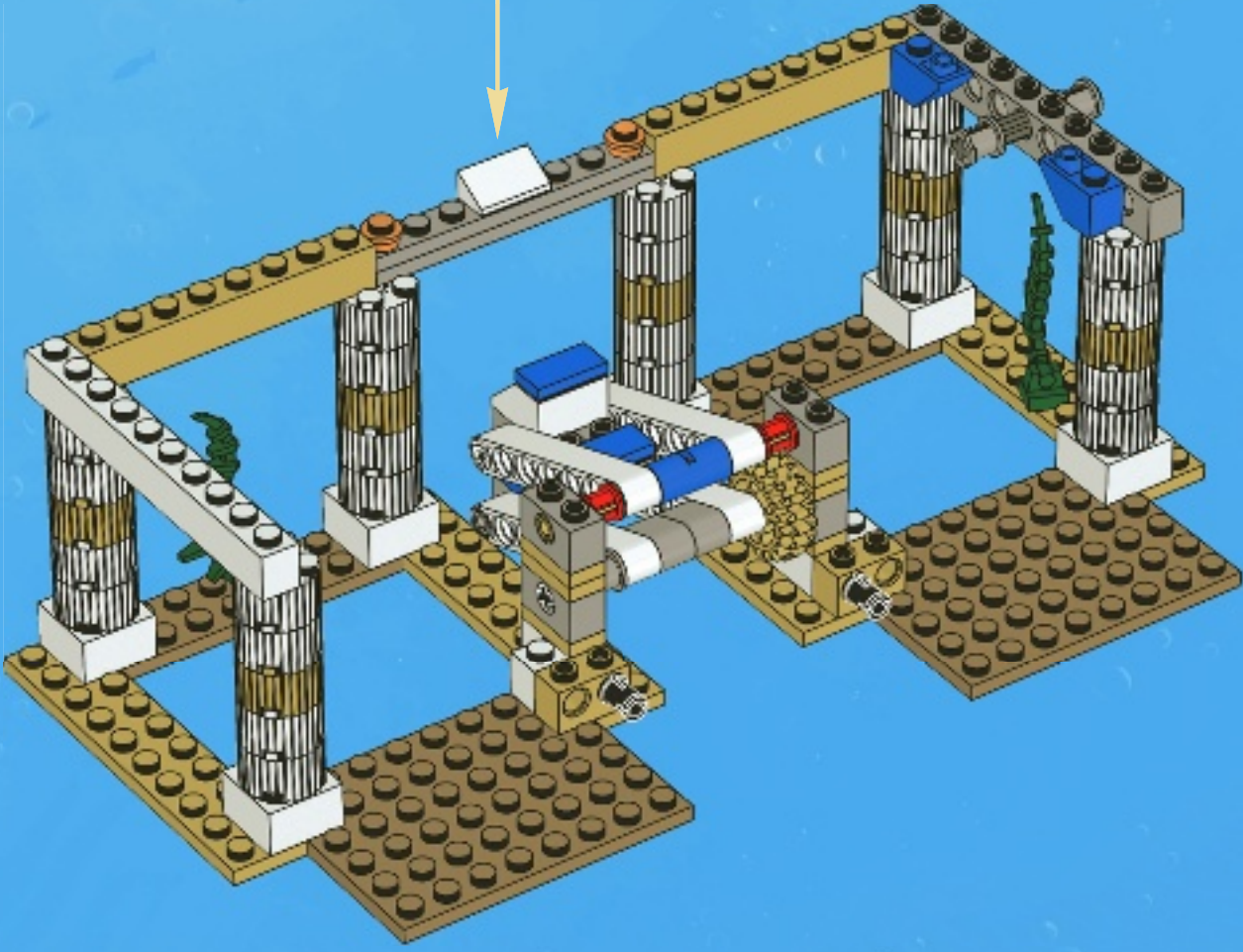
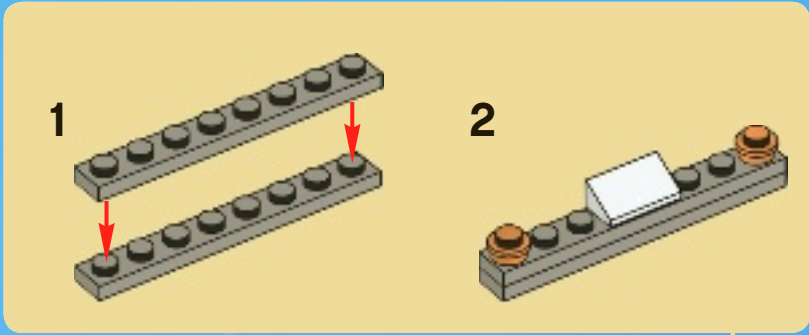

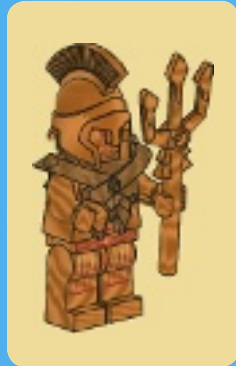

11

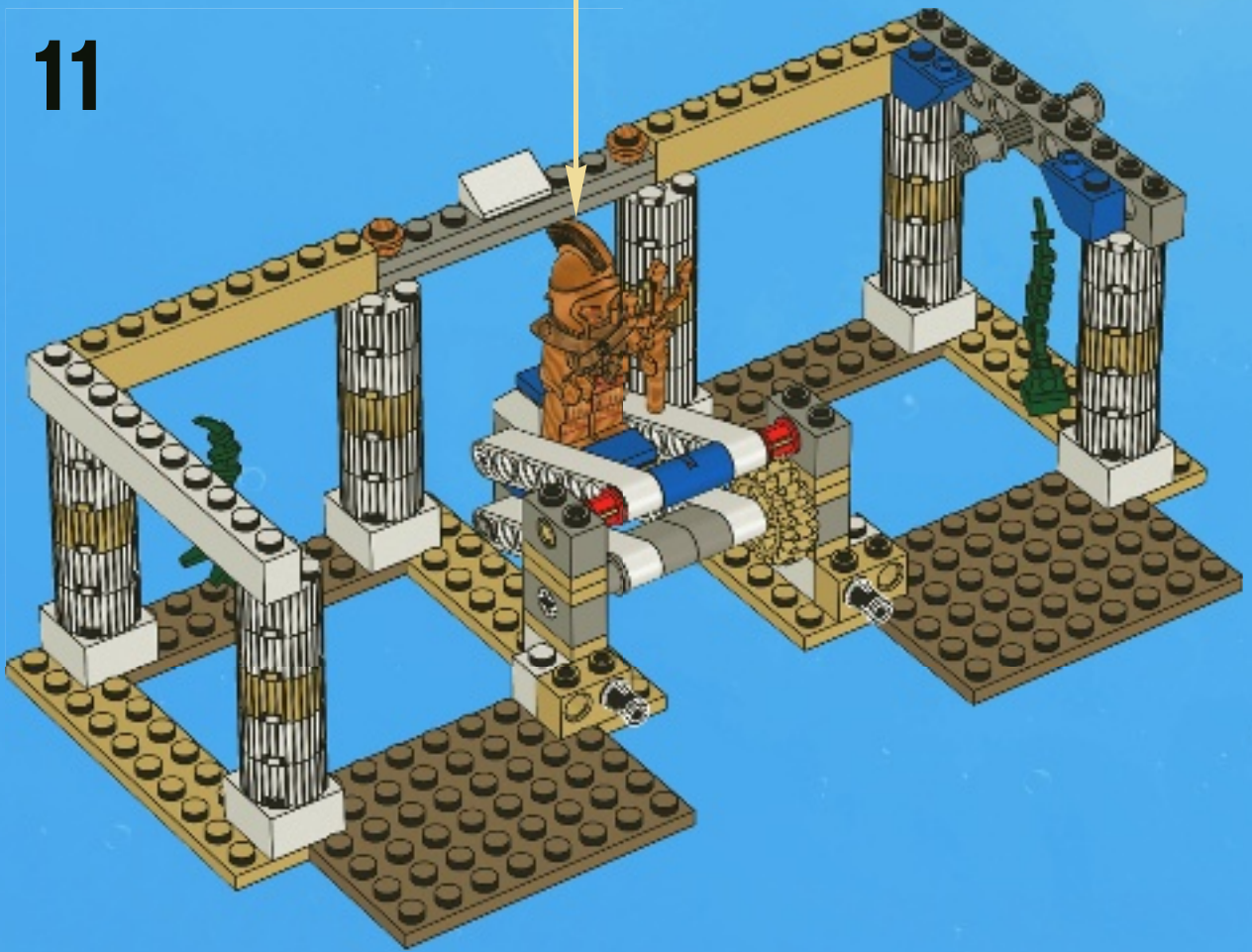



6x



4x

12

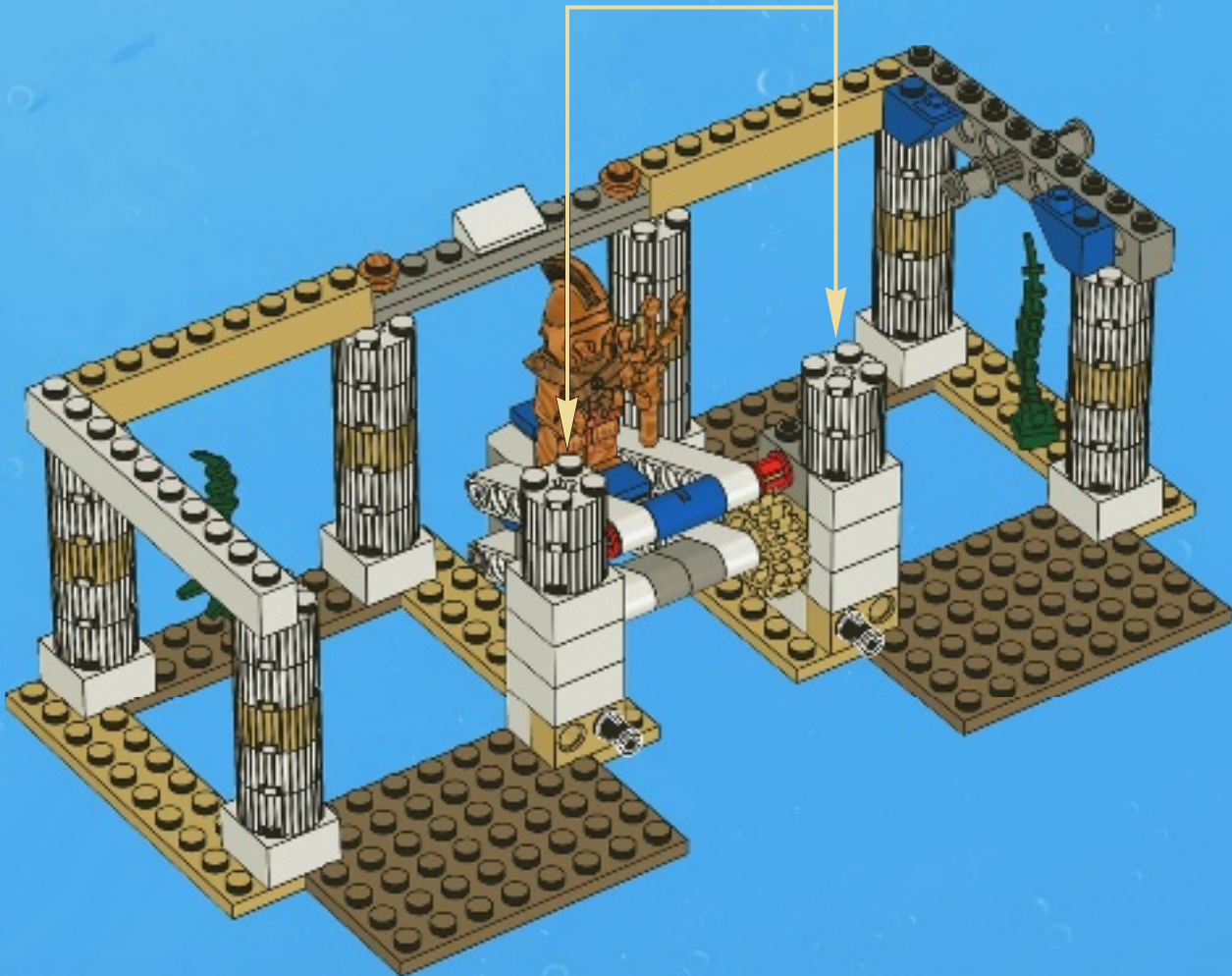
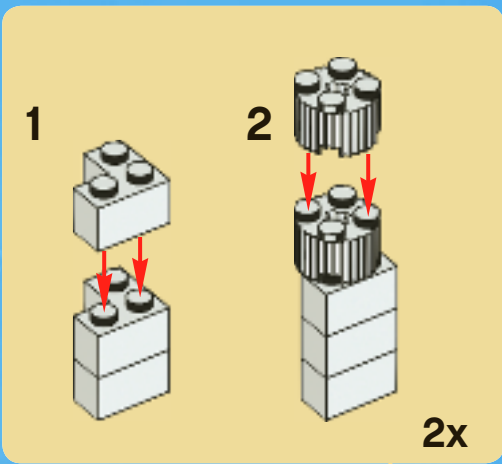

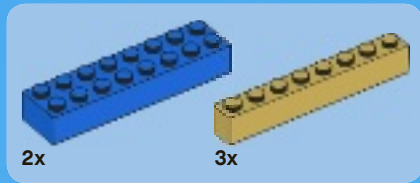

13

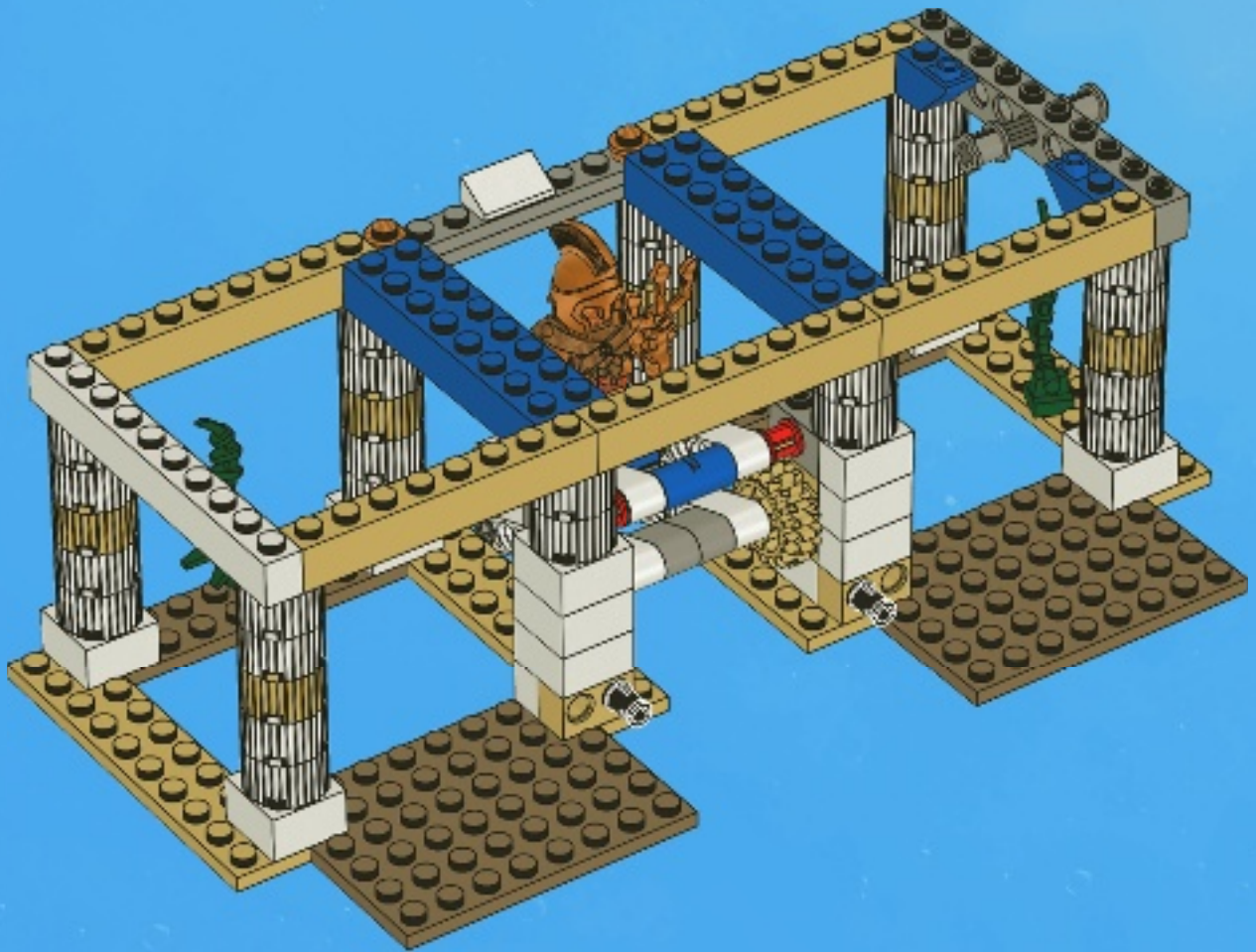

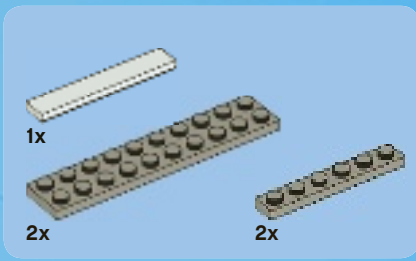

14

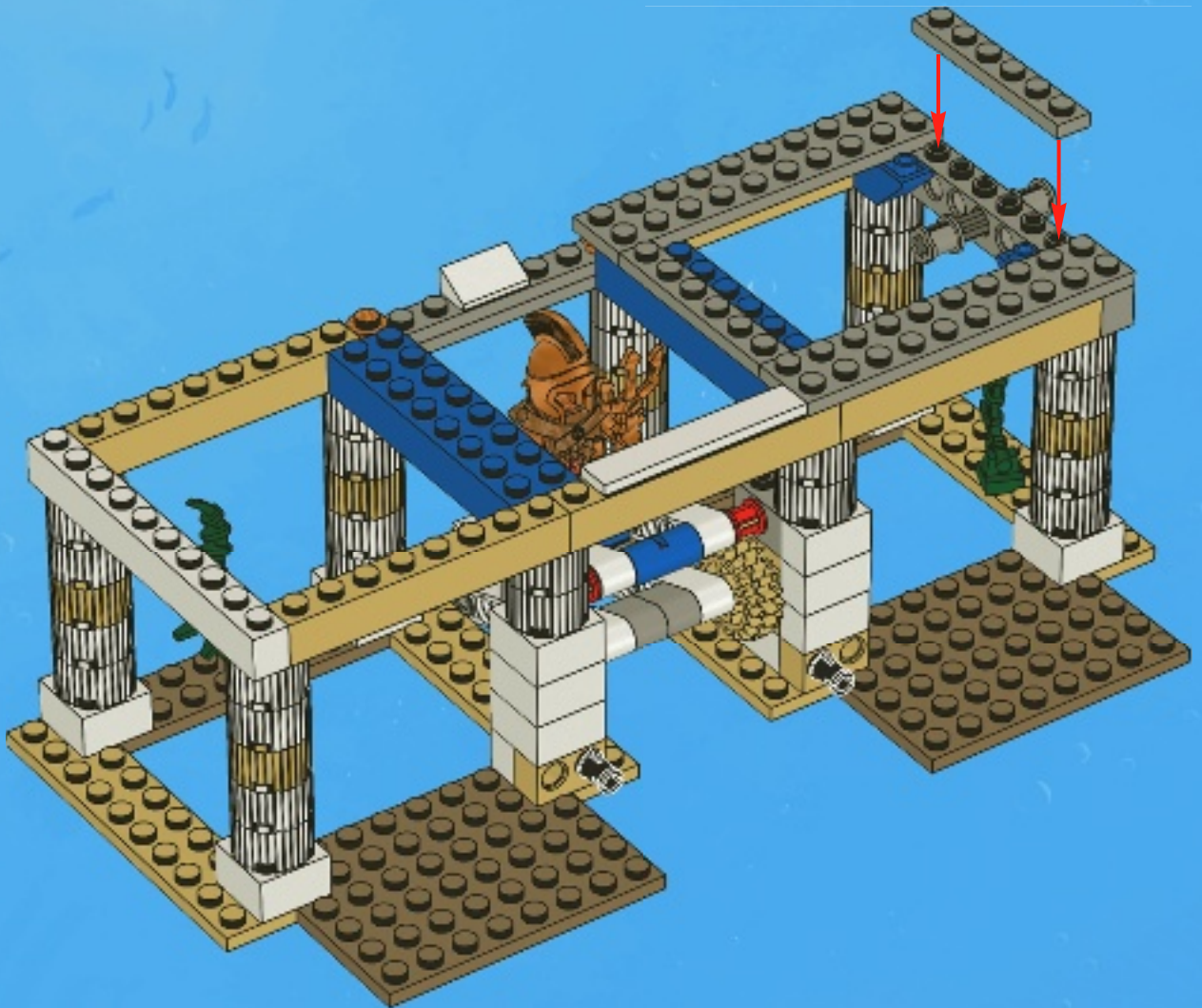

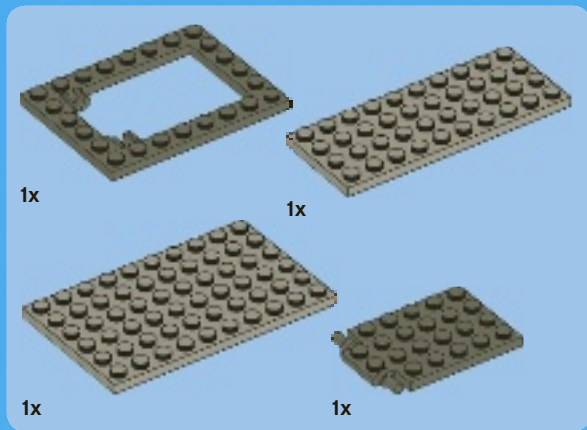

15

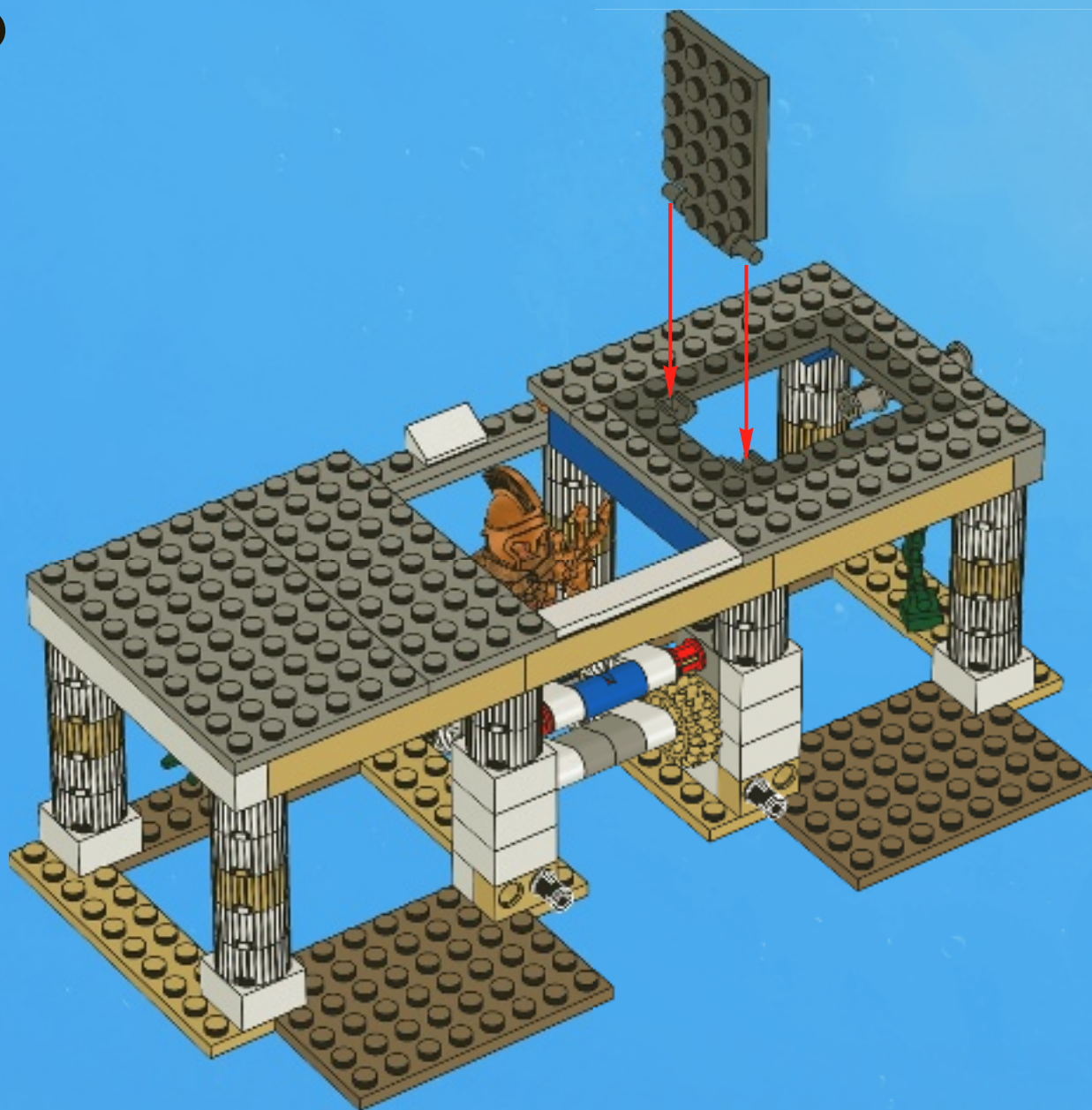



4x



2x

16

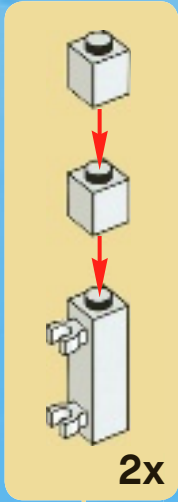

2x

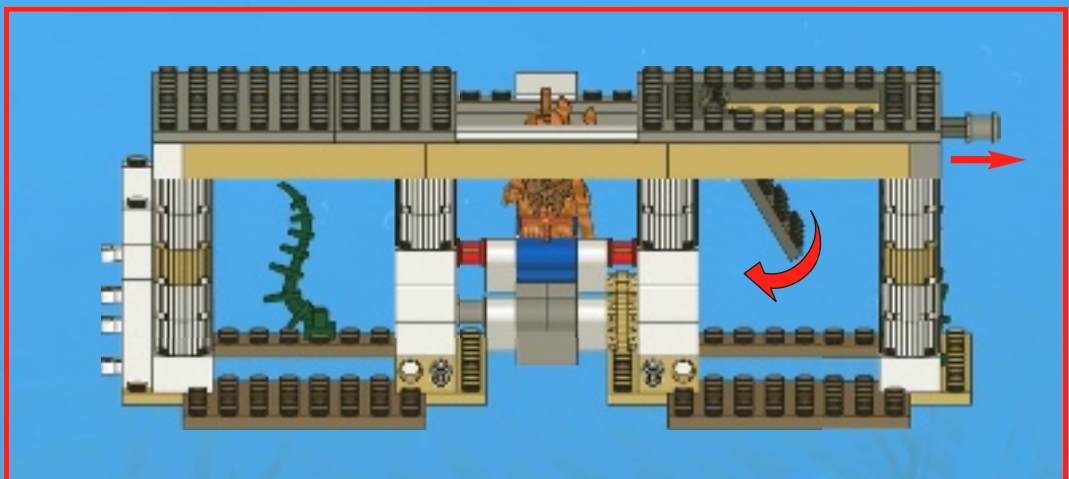
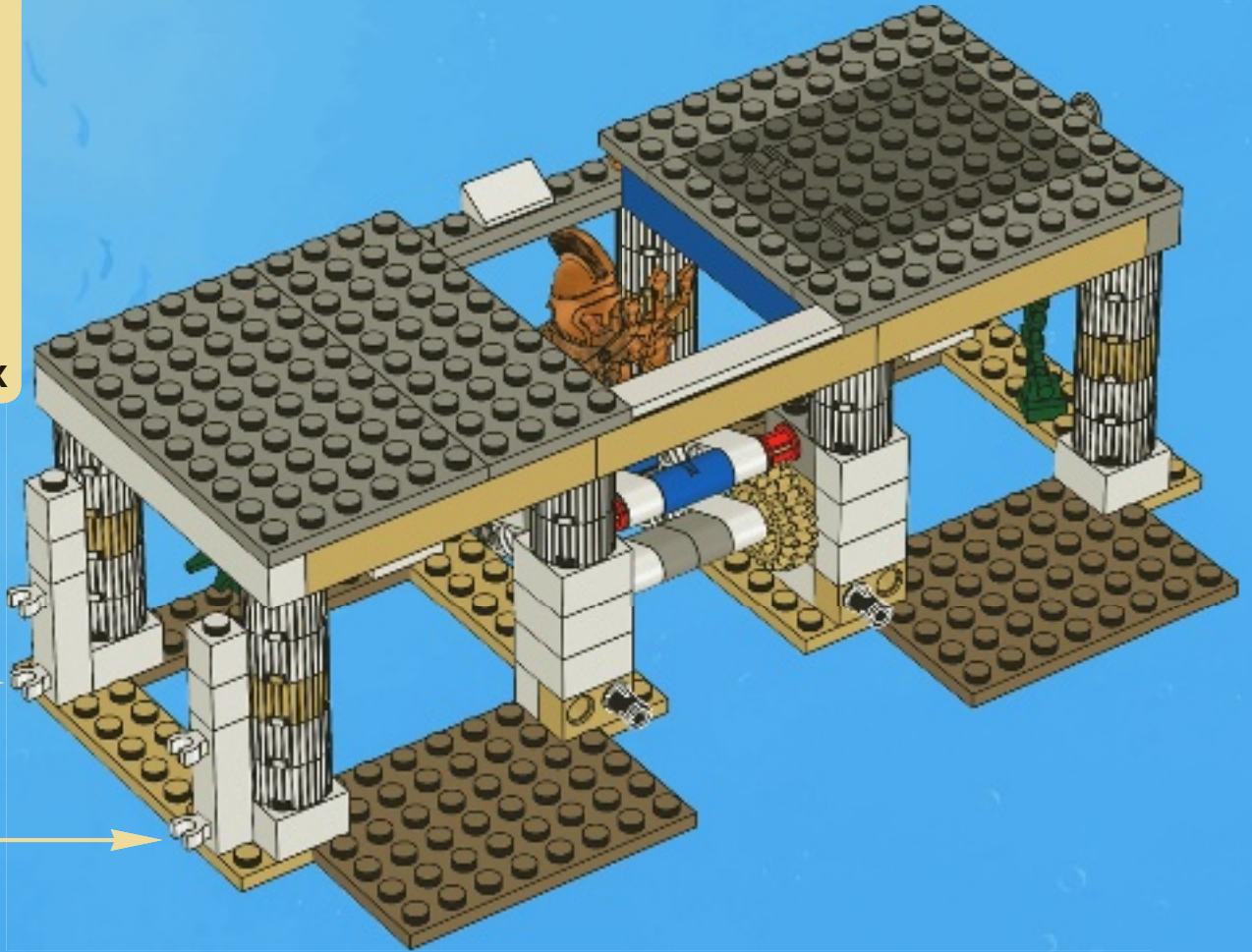

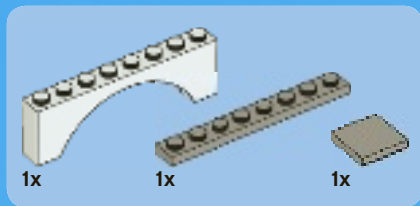

17

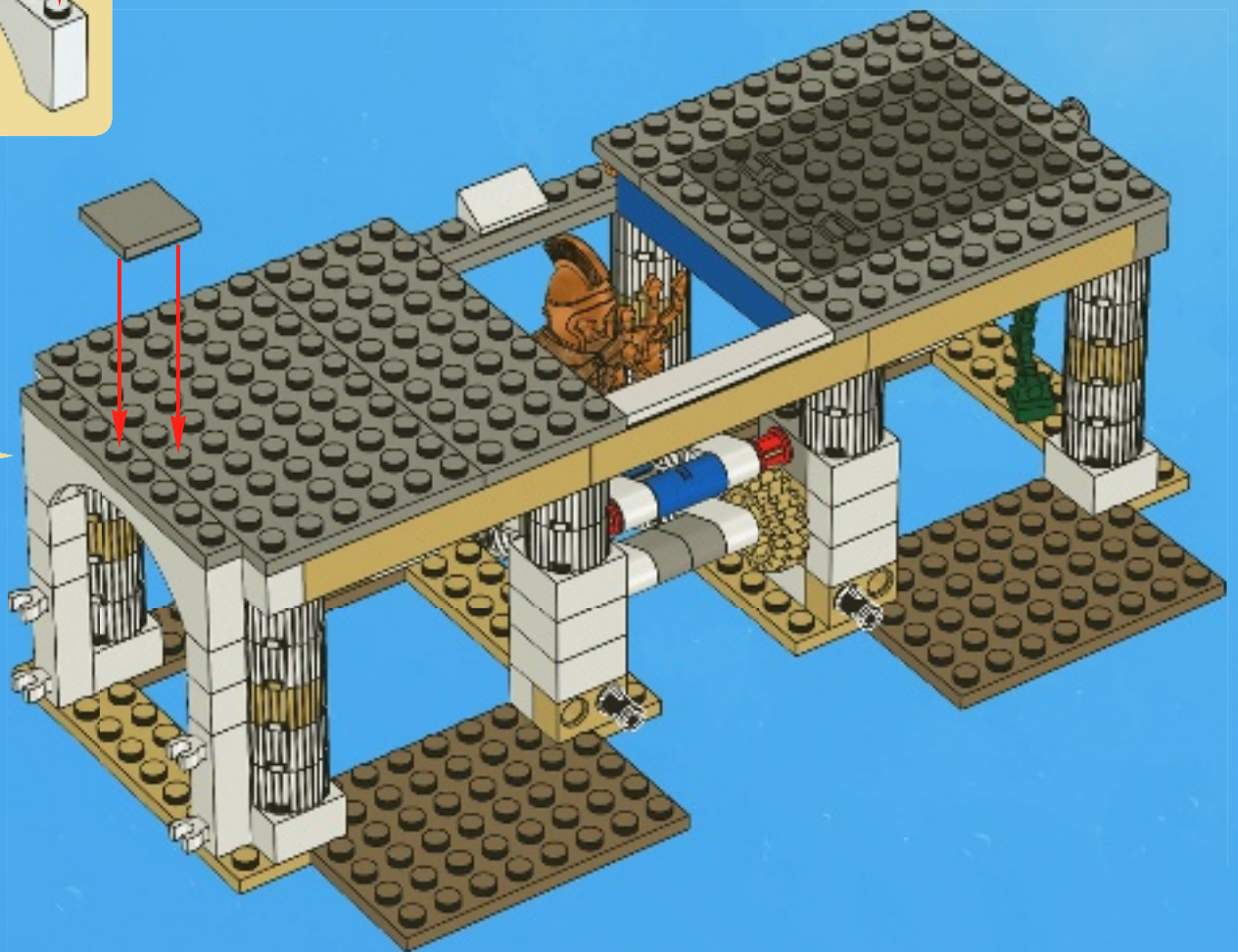
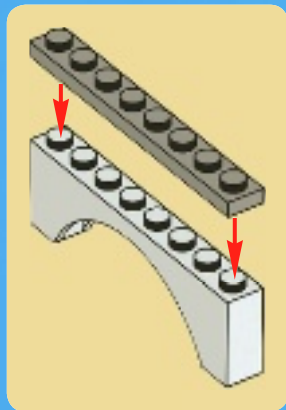

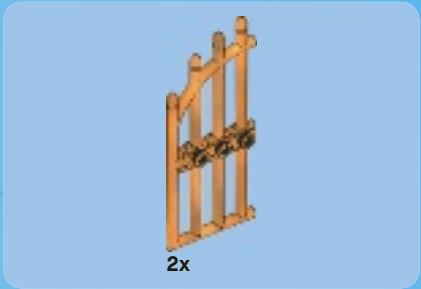

2x

18

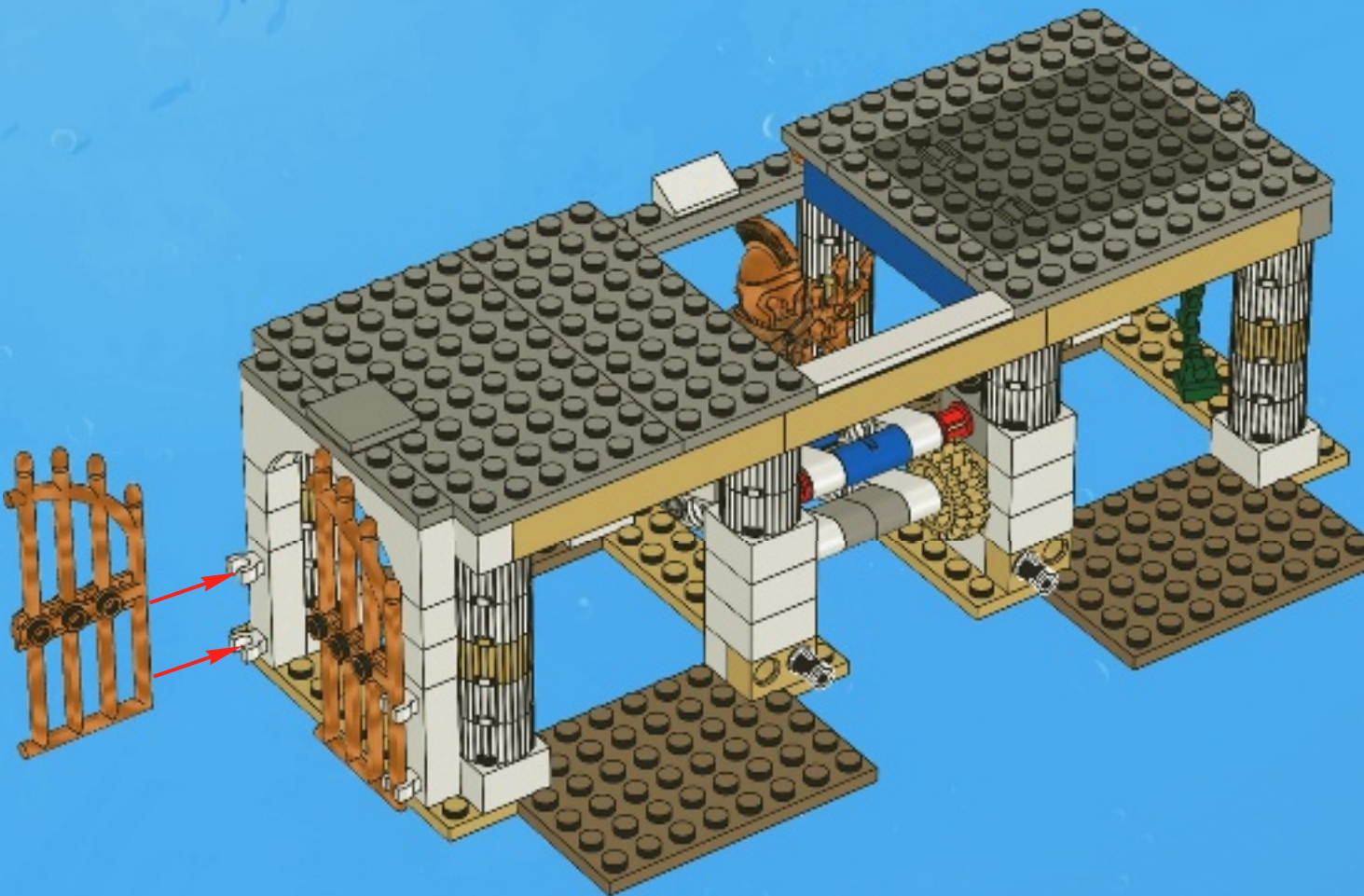



1x

19

1



2

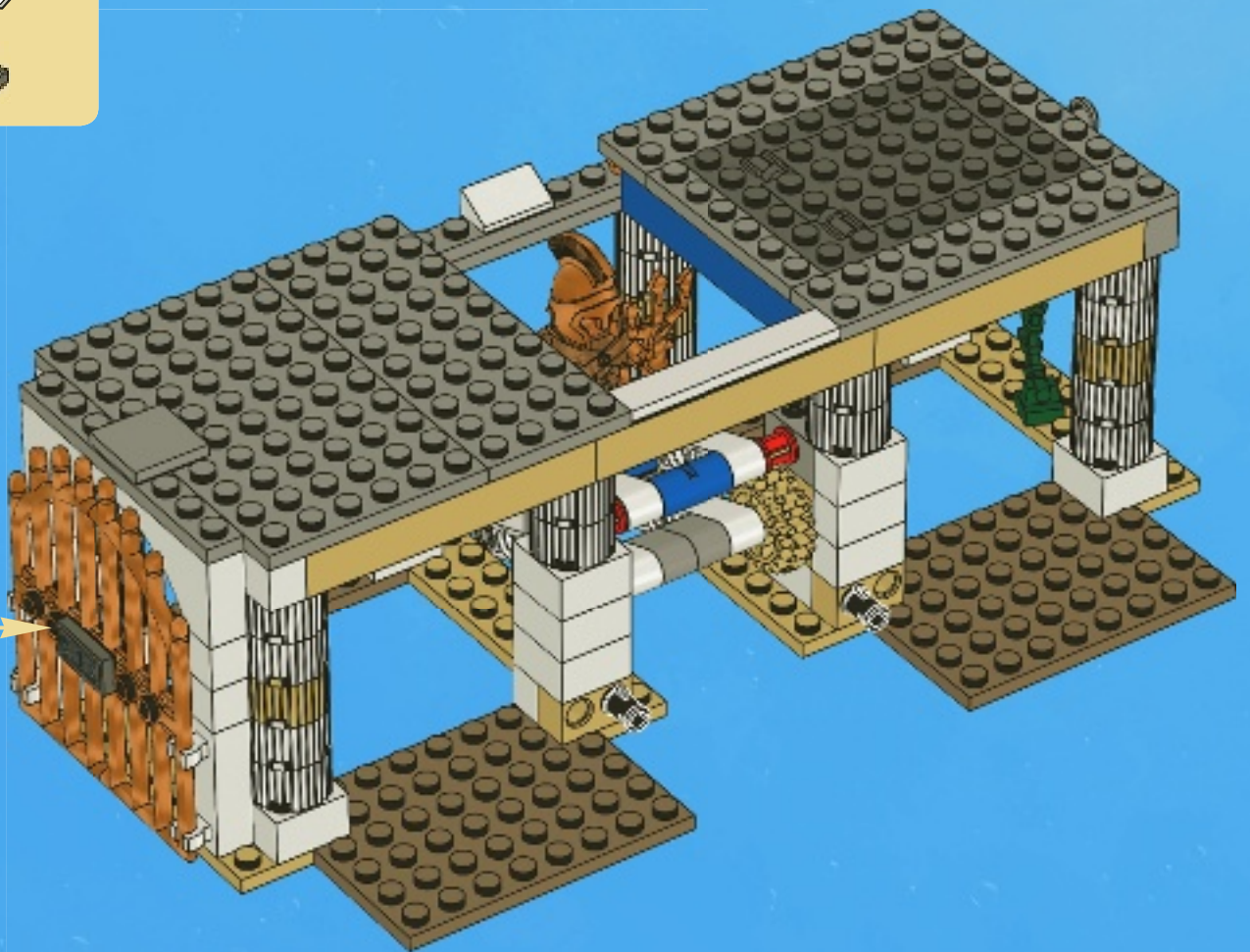
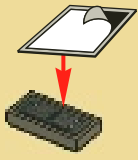



1x

1

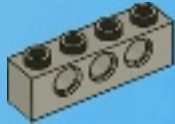

2x

2

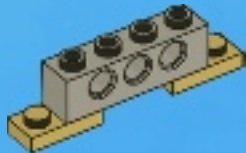

2x

3

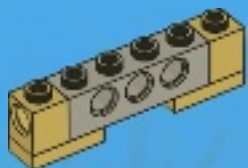

2x

4

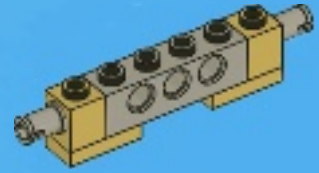

1x



2x

5

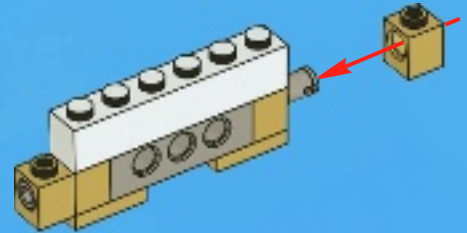

1x

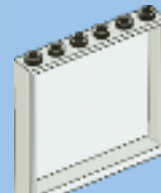

1x

6

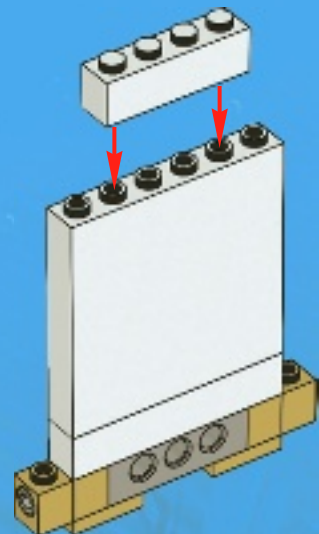



1x



2x

7

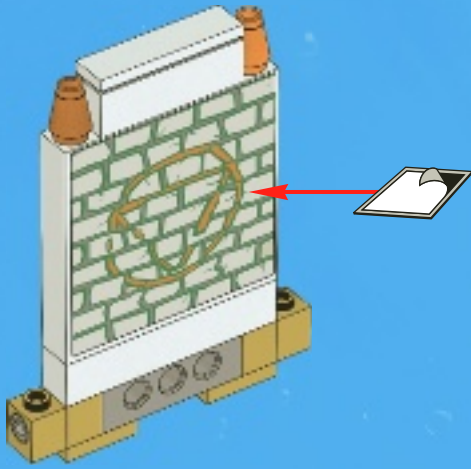

8

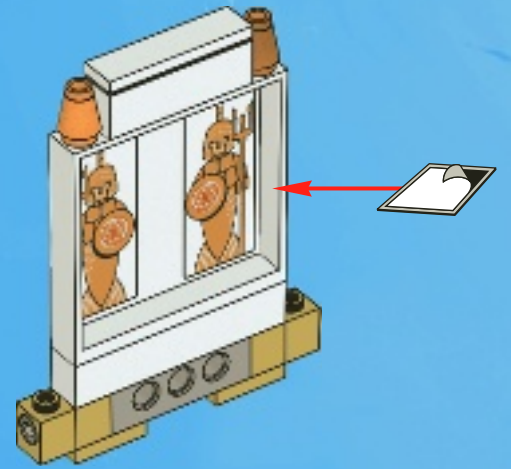

20

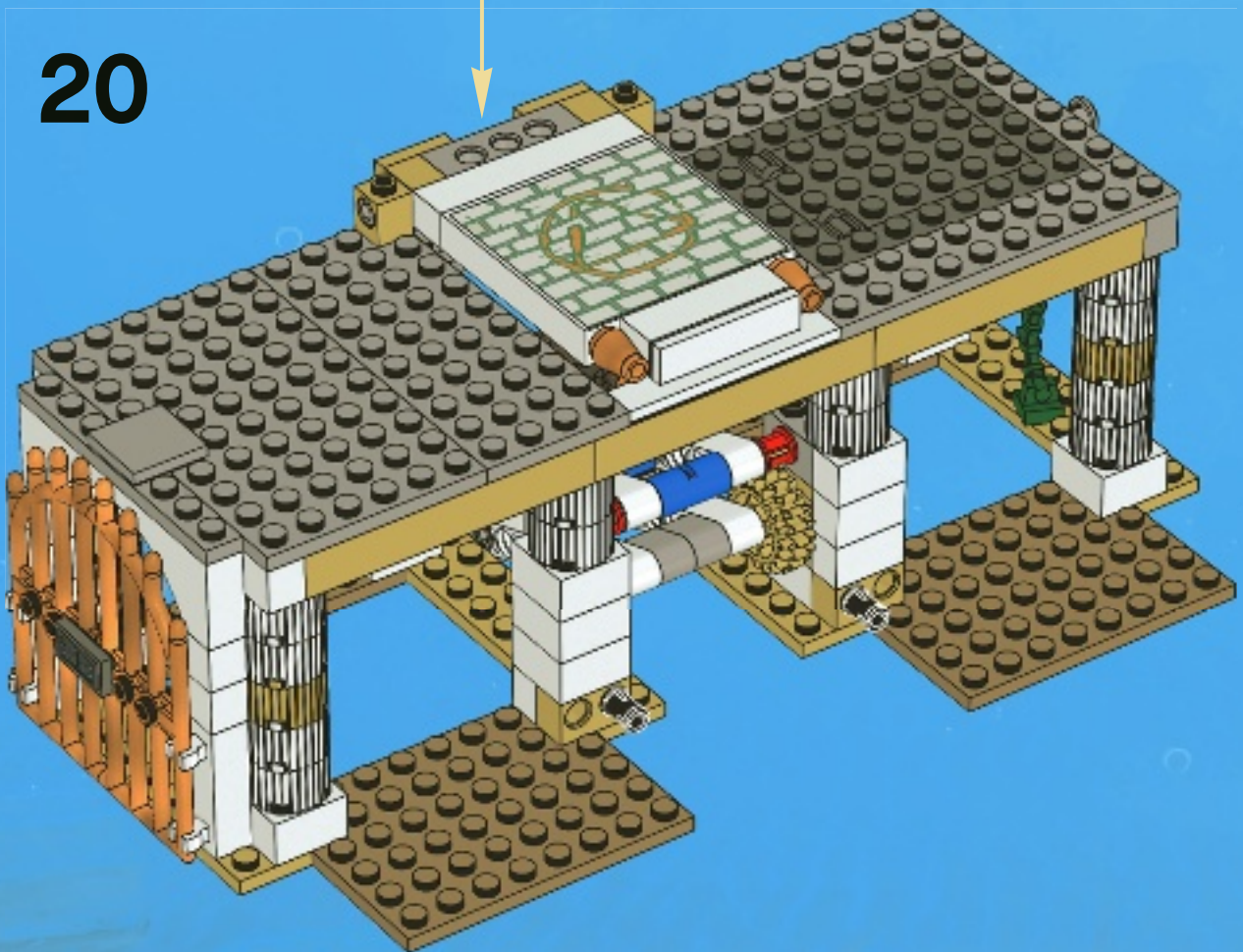



6x



2x

21

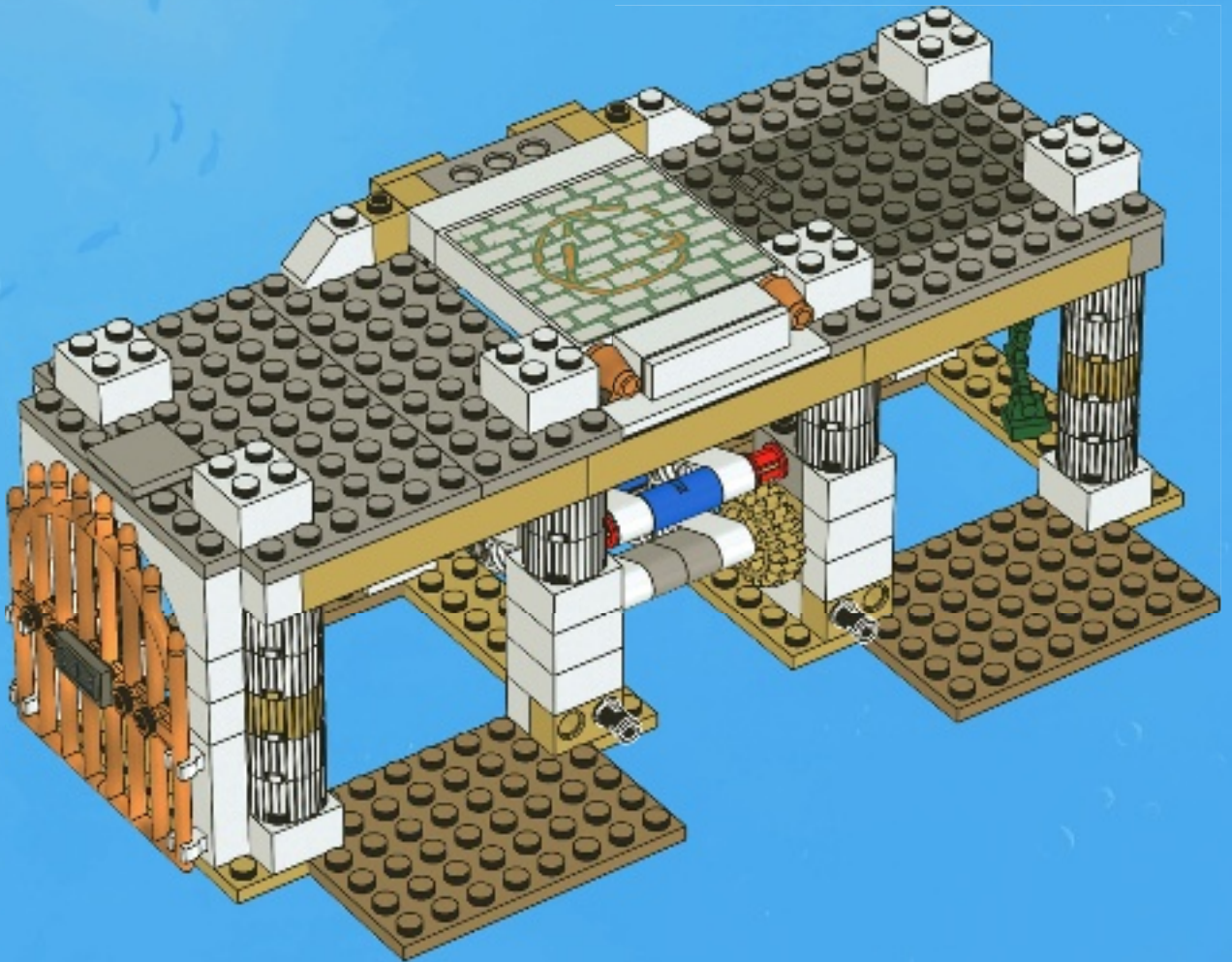

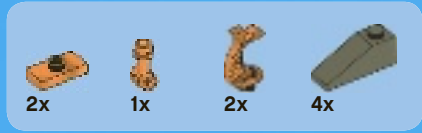

22

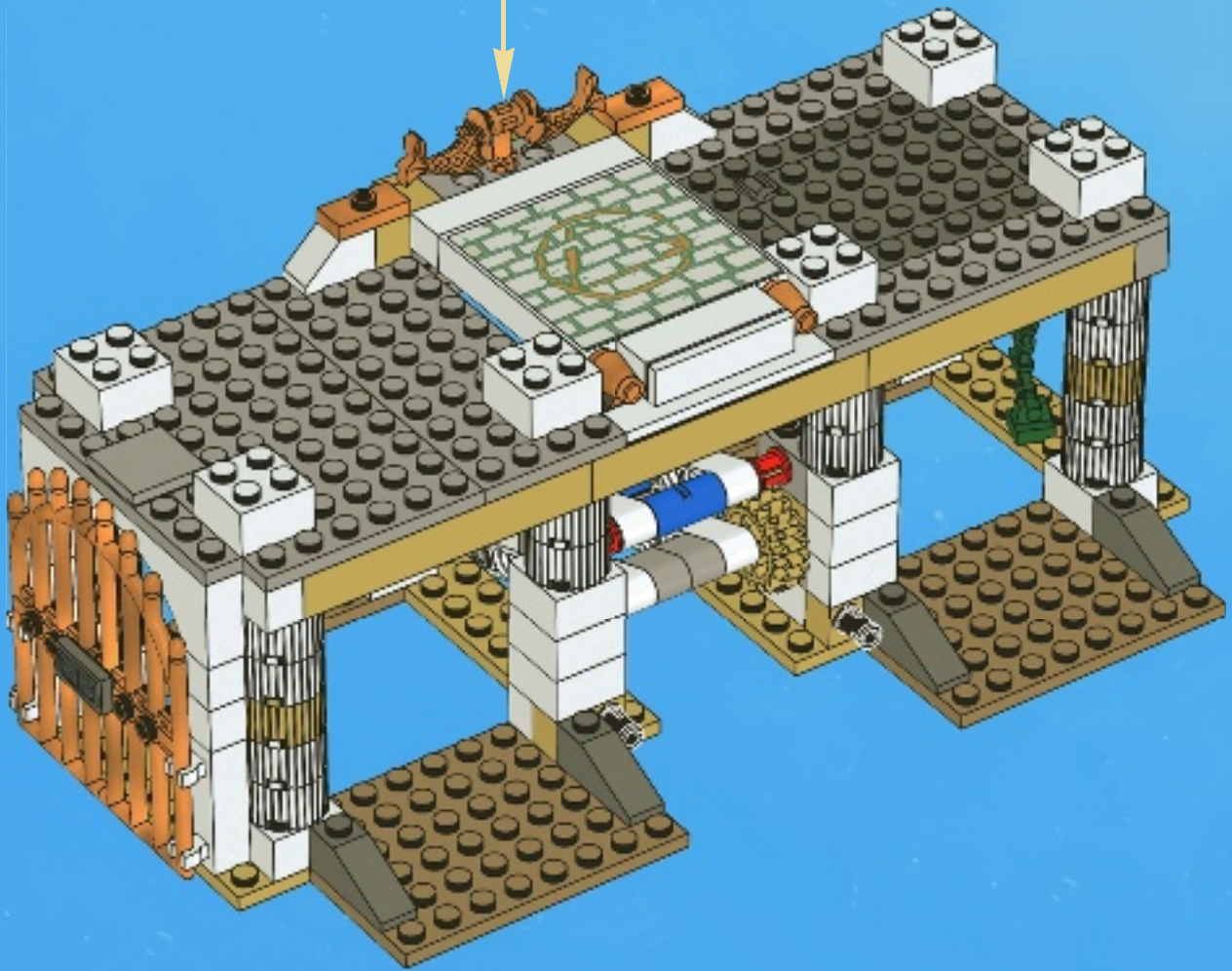
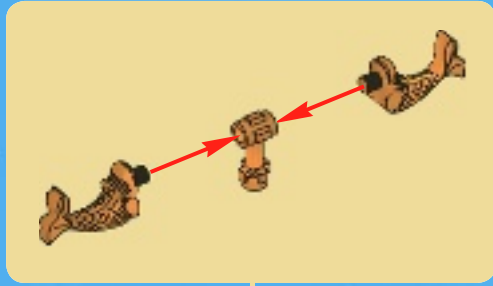



2x



2x



4x

23

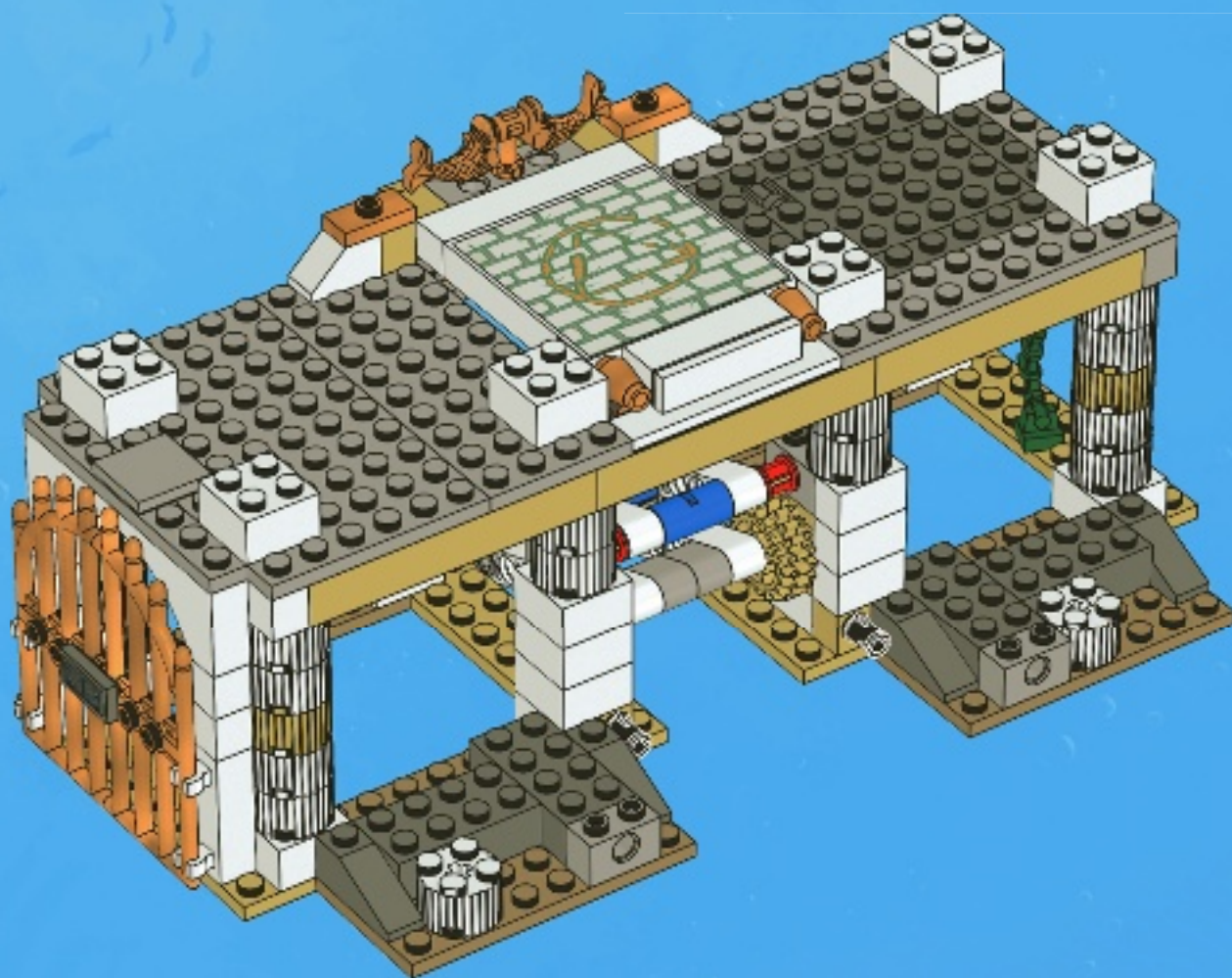

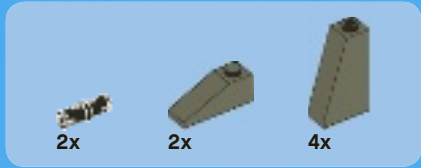

24

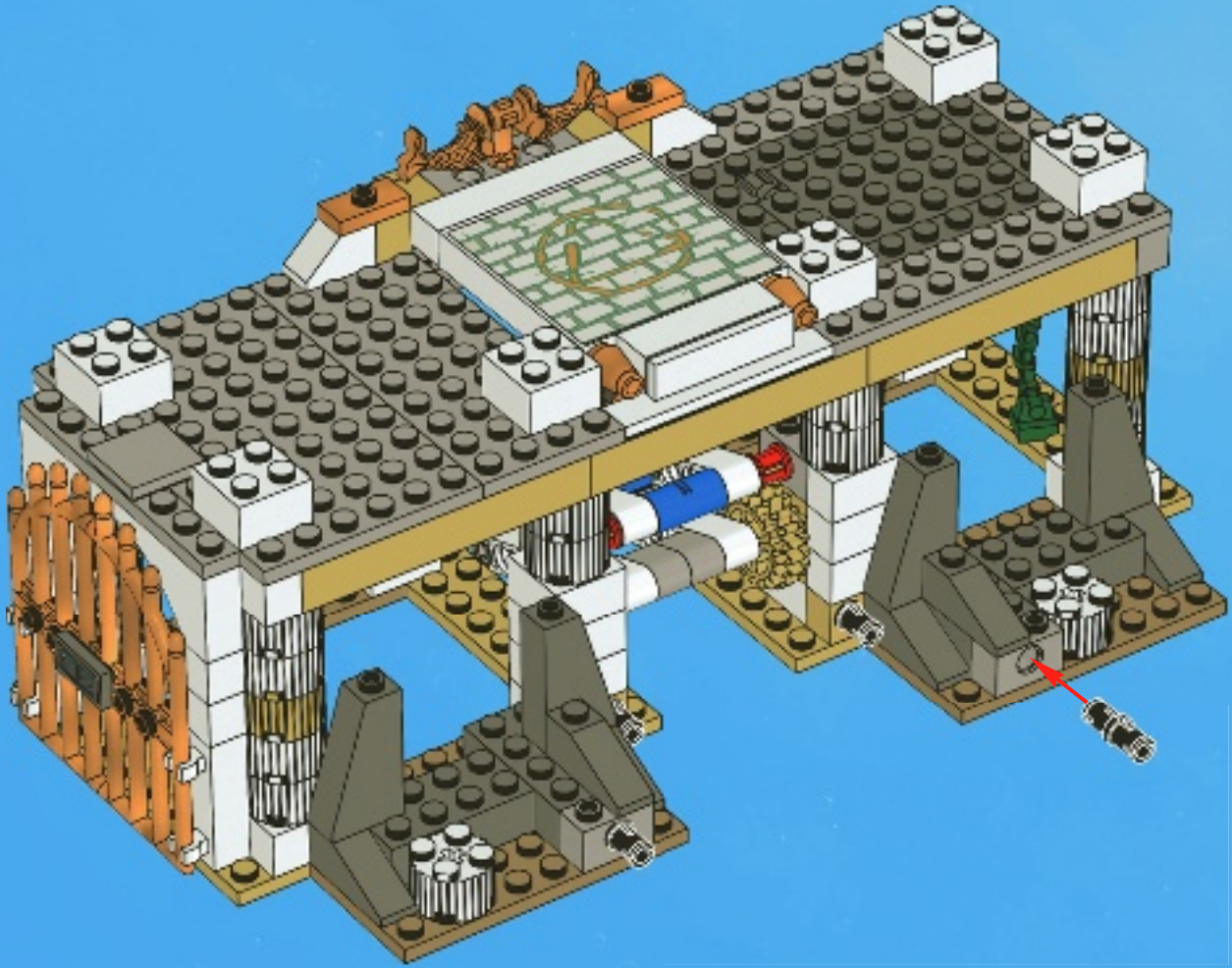

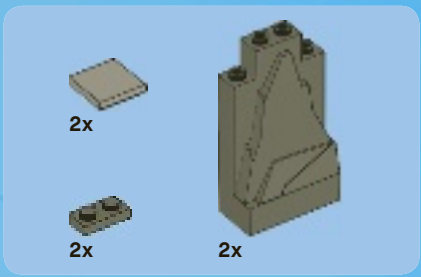

25

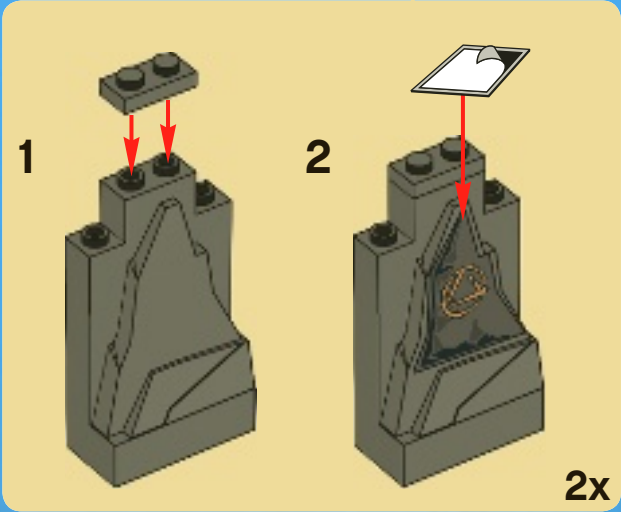
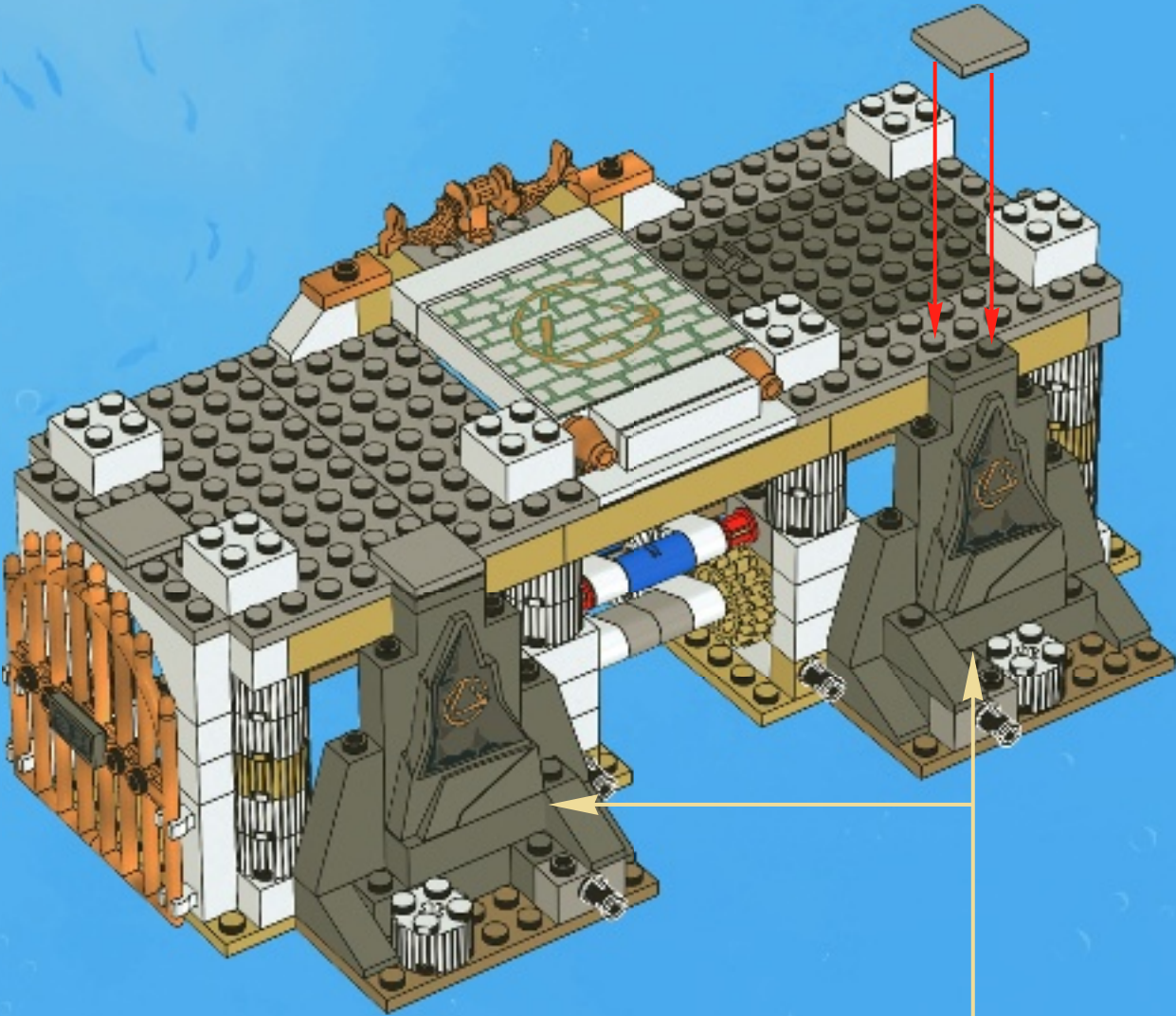

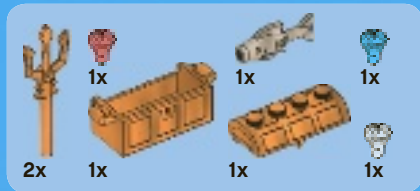

26

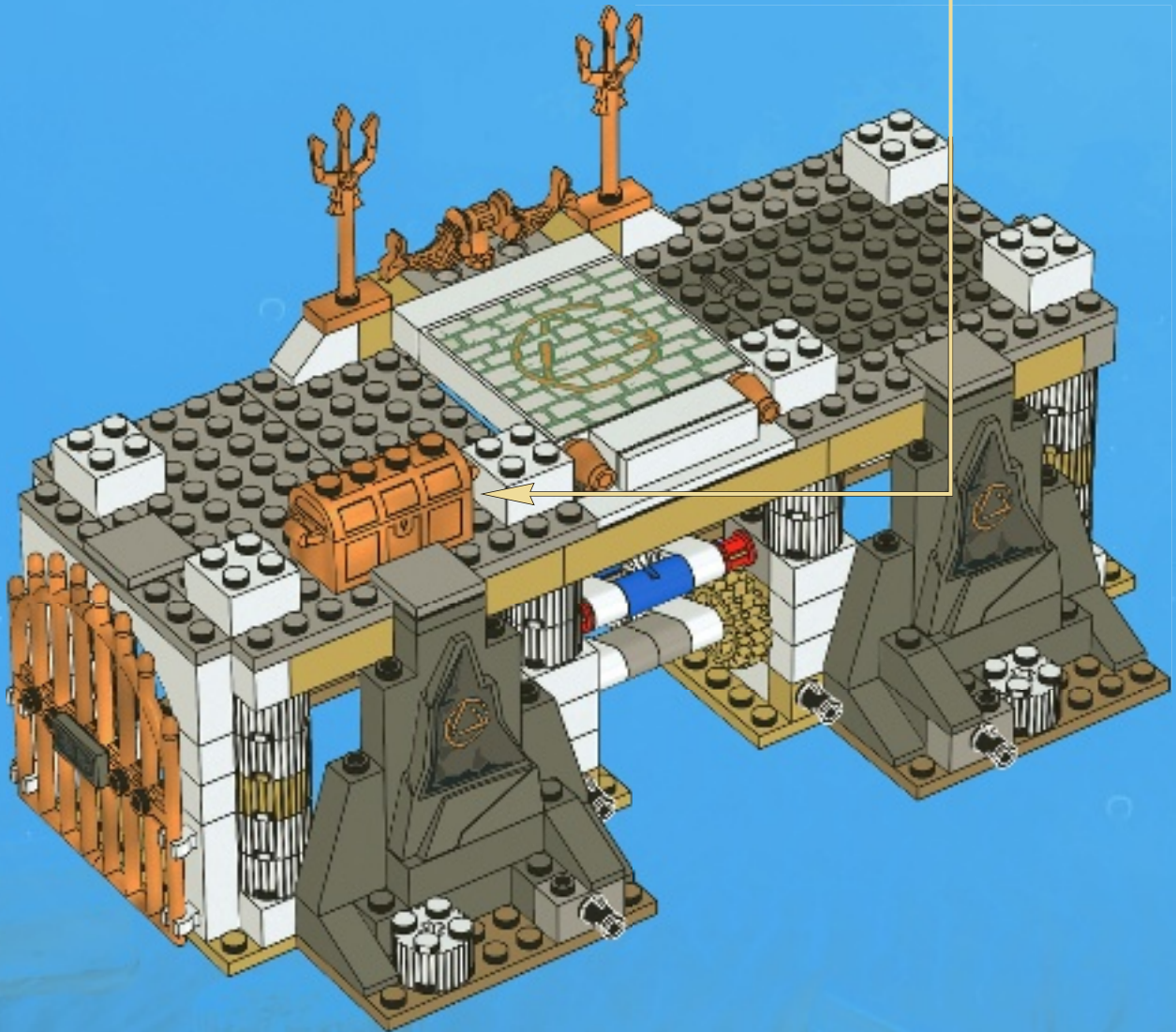
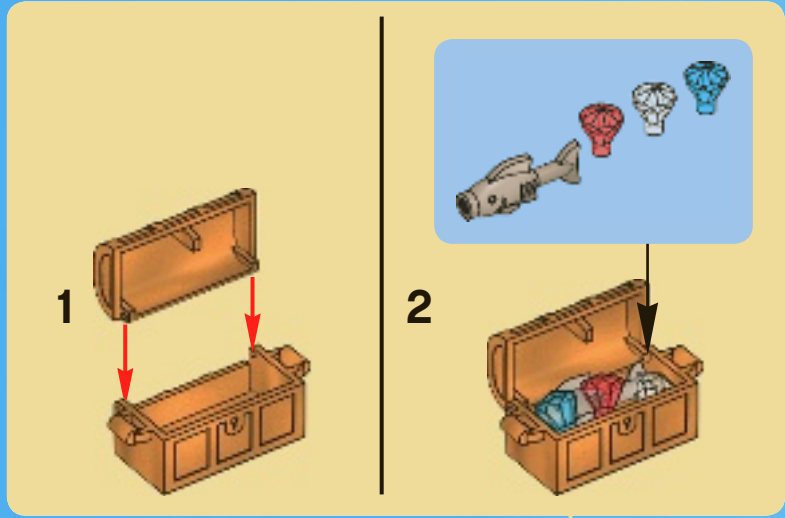



4

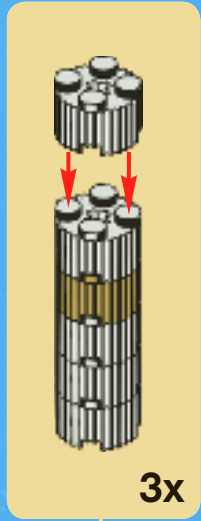

3x



27x



9x

27

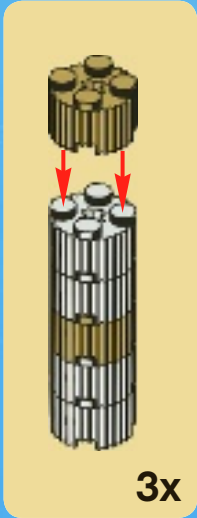

3x

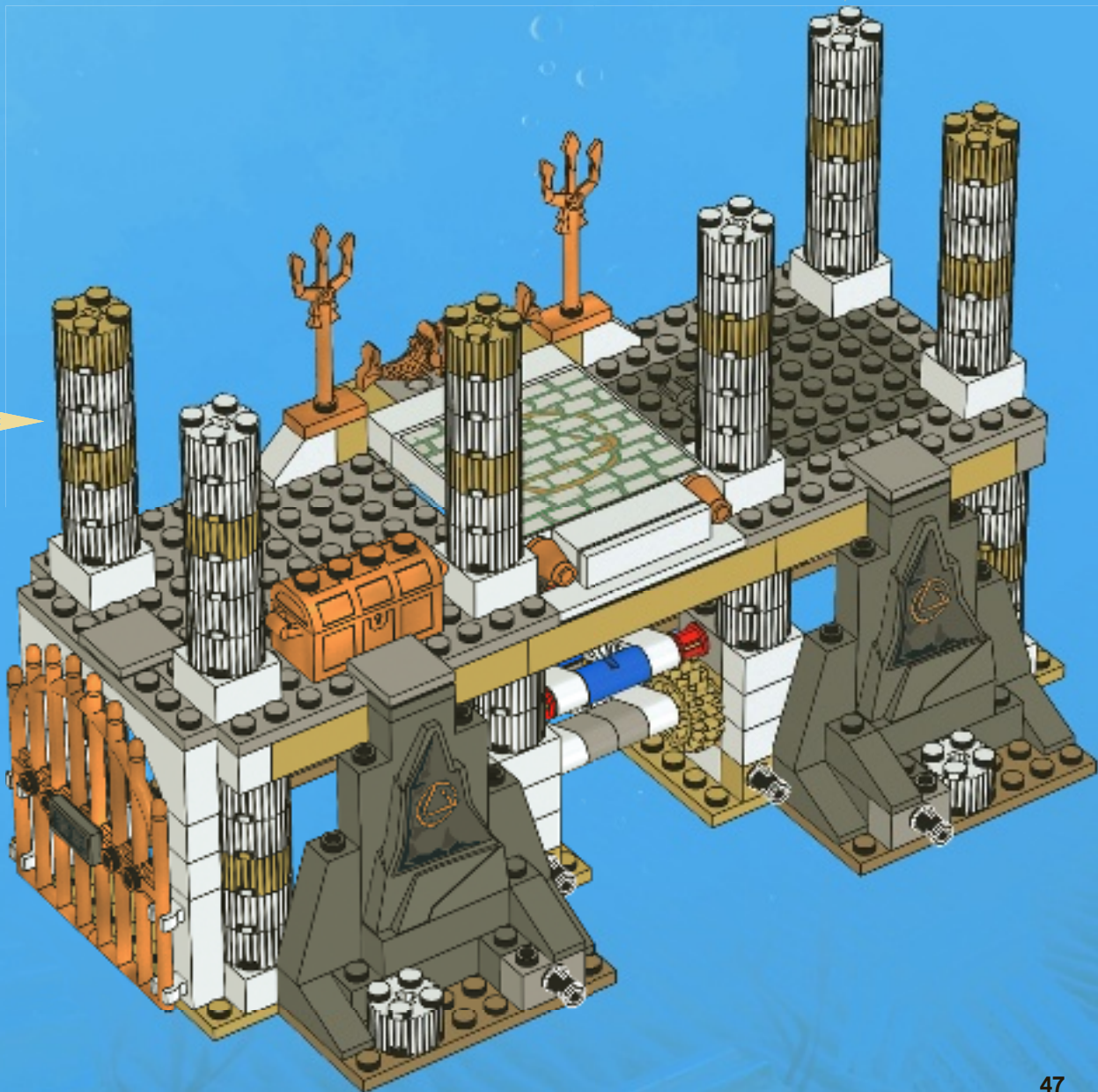



1x



1x

1



1x



1x

2

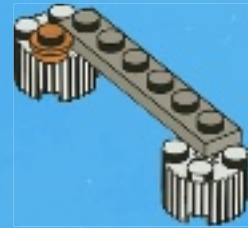

3x



3x

3

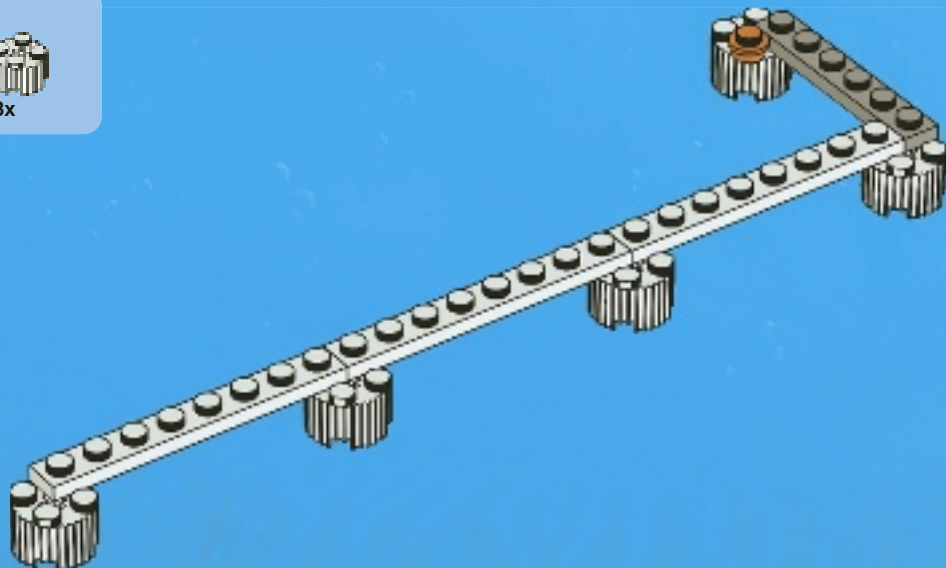



4

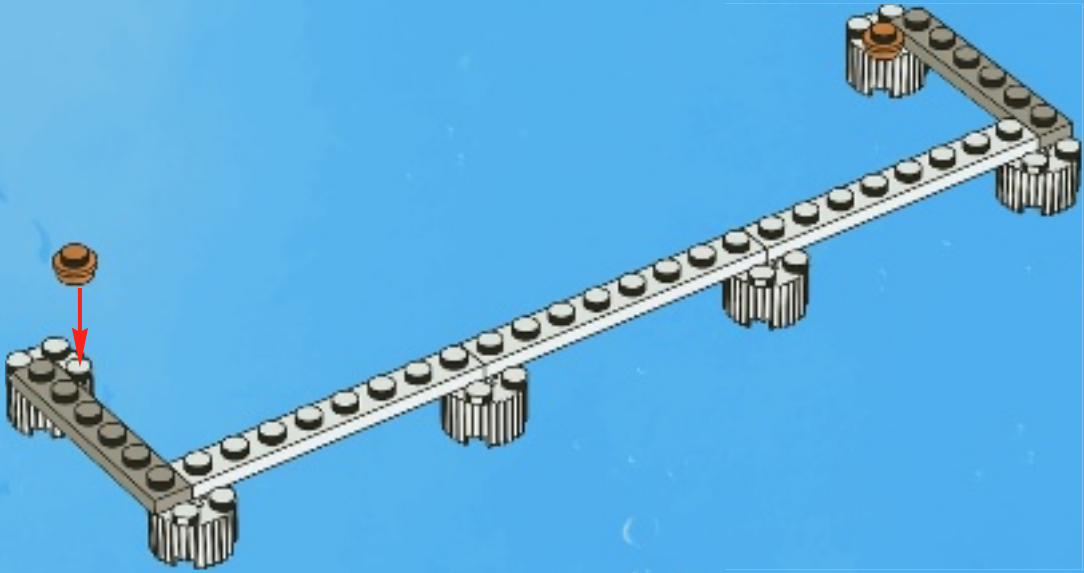

5



6x

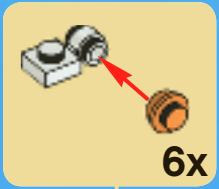

6x

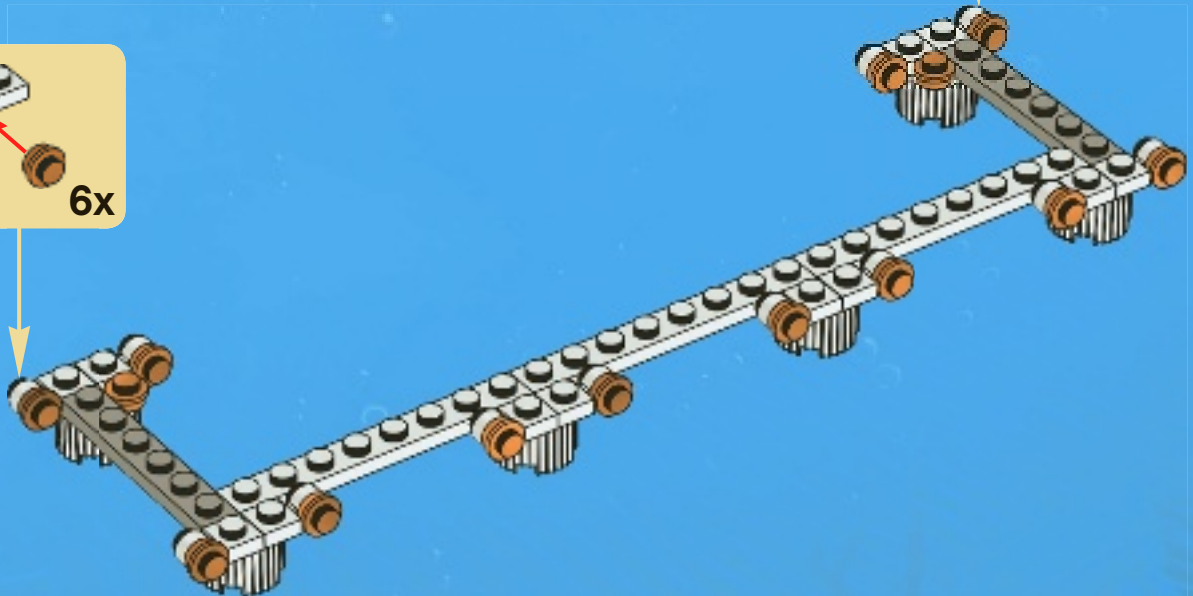



6x

6

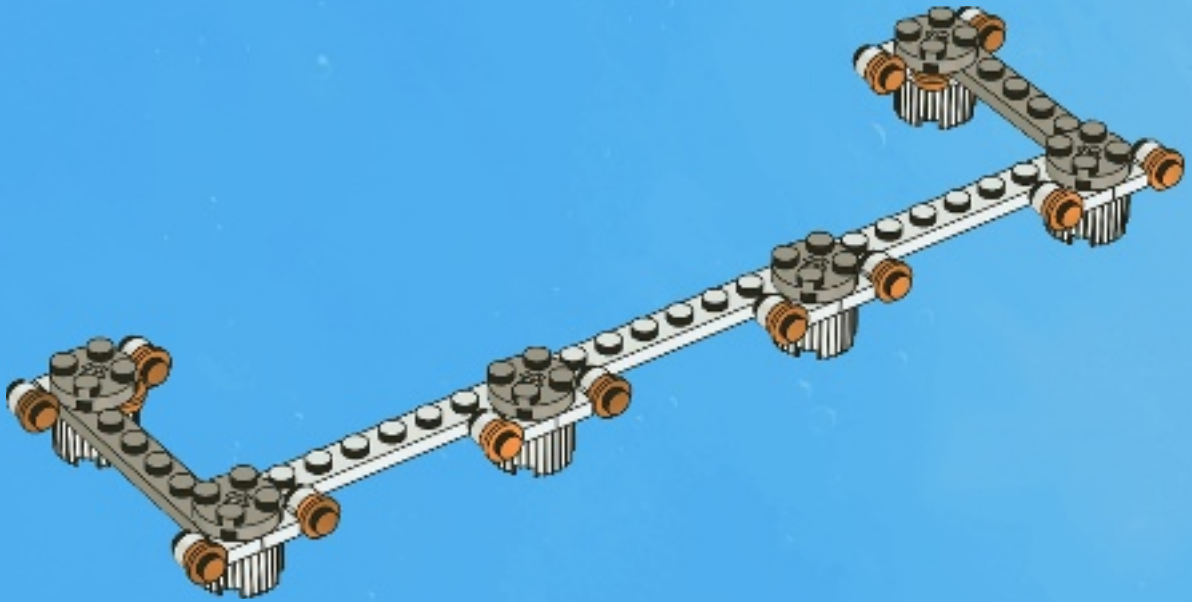

2x



3x

7

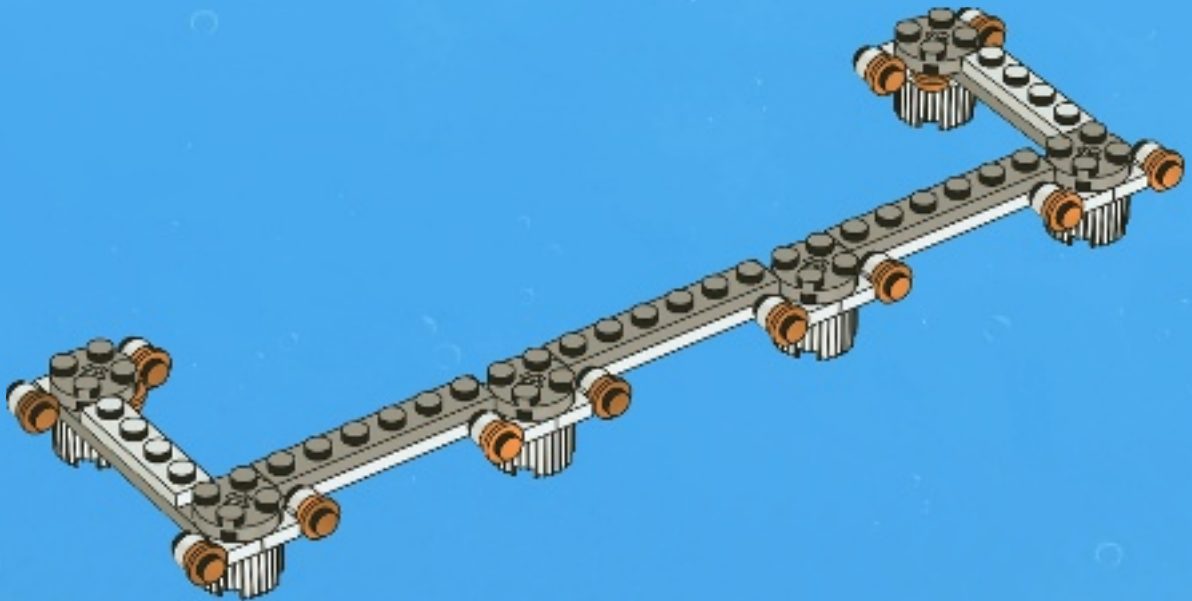



5x

8

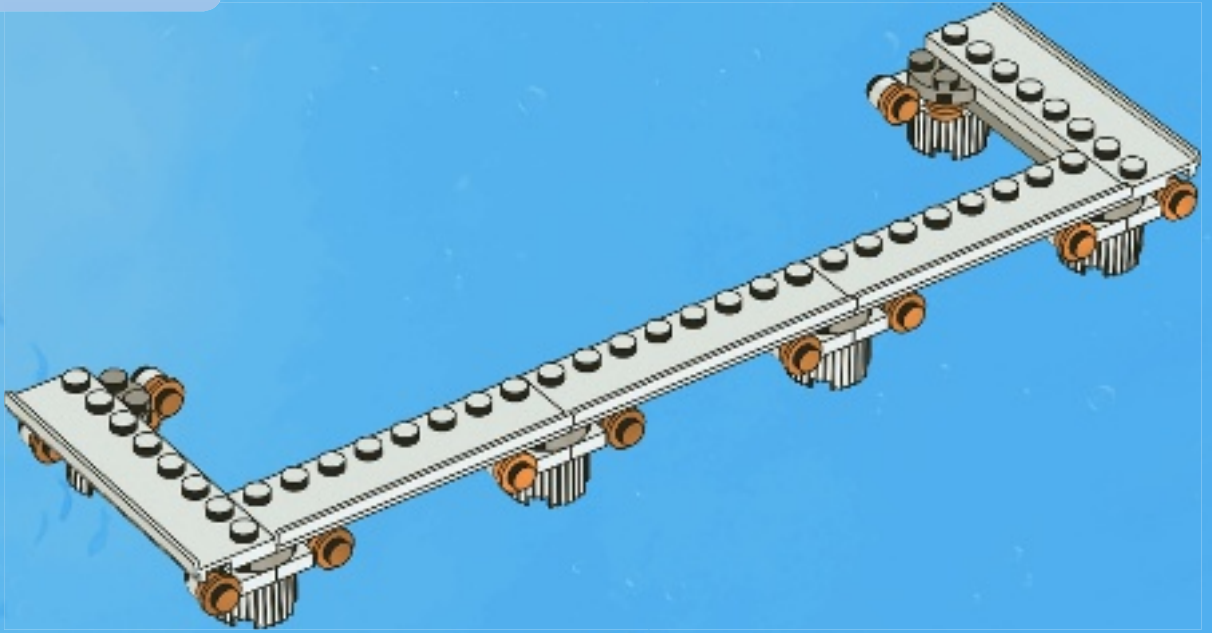

2x



2x



2x



4x

9

1

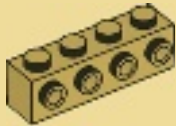

2

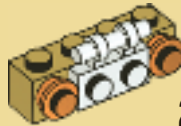

2x

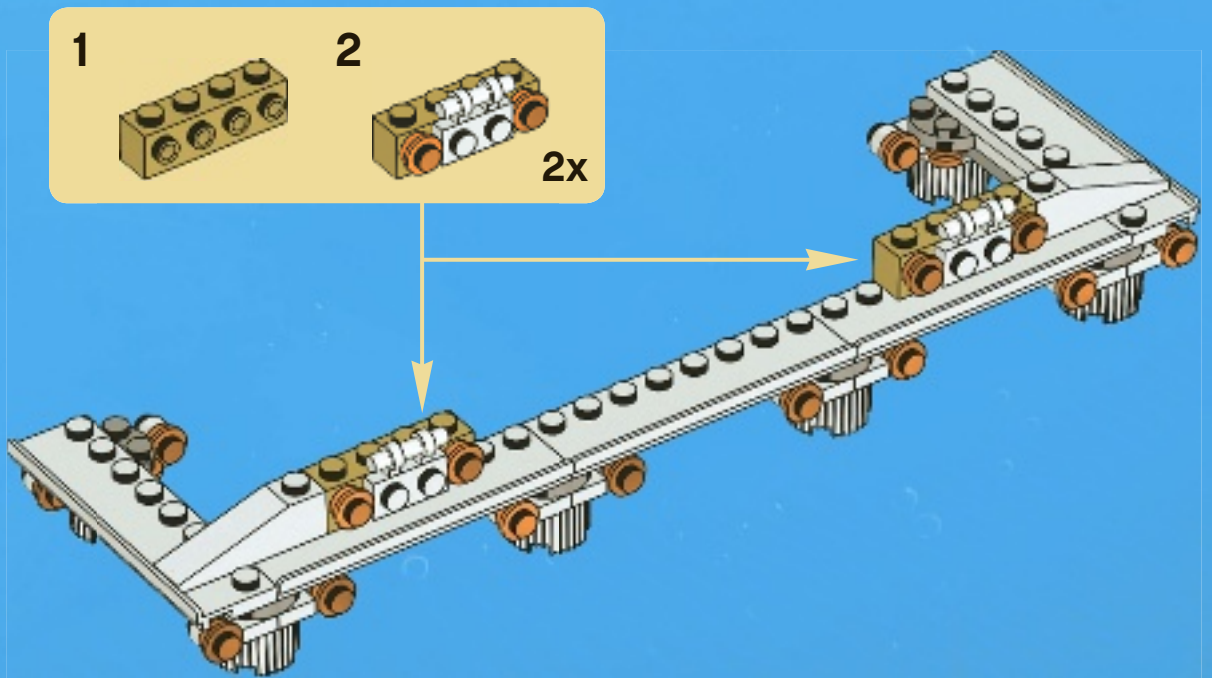



2x



2x

10

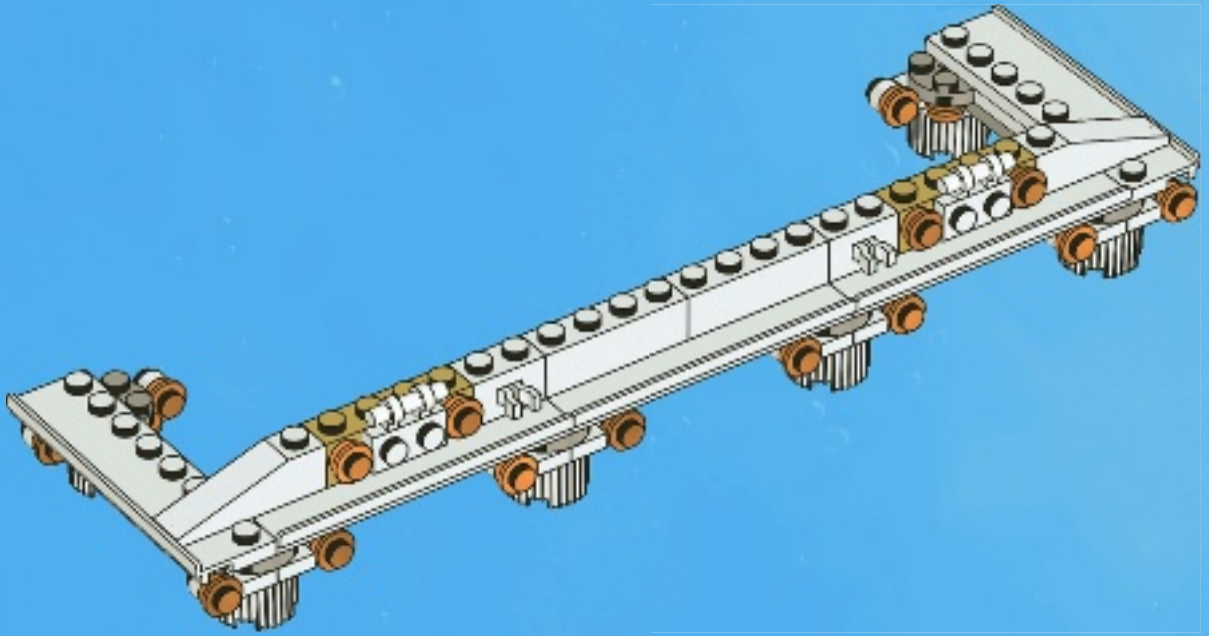

2x



1x



2x

11

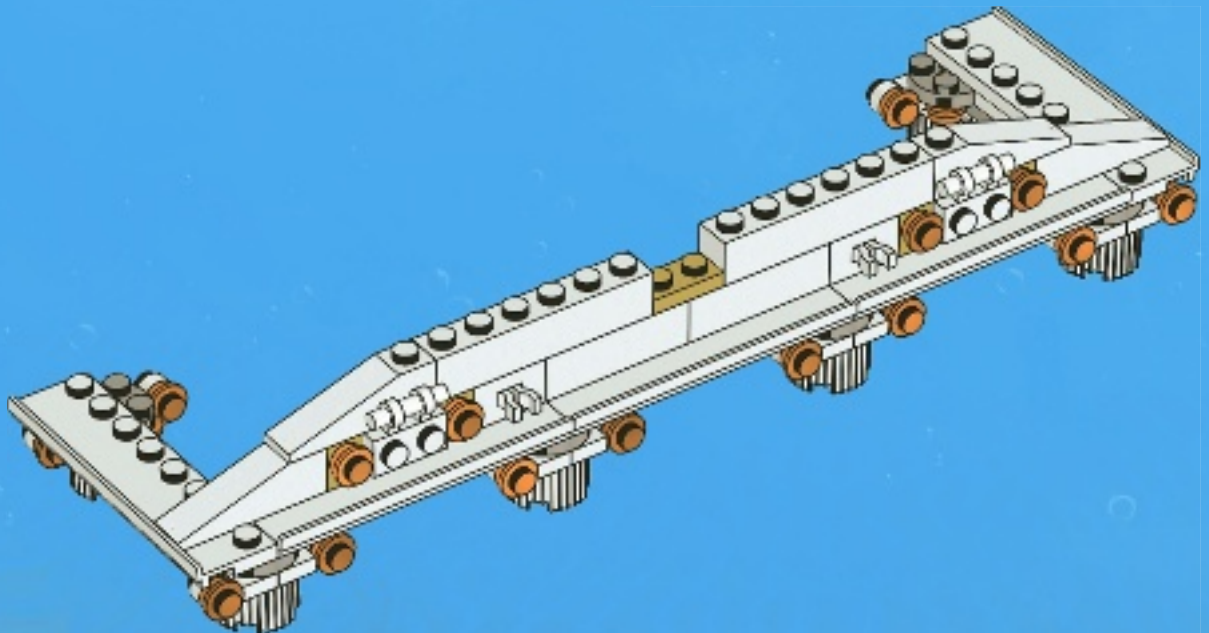



1x



2x

12

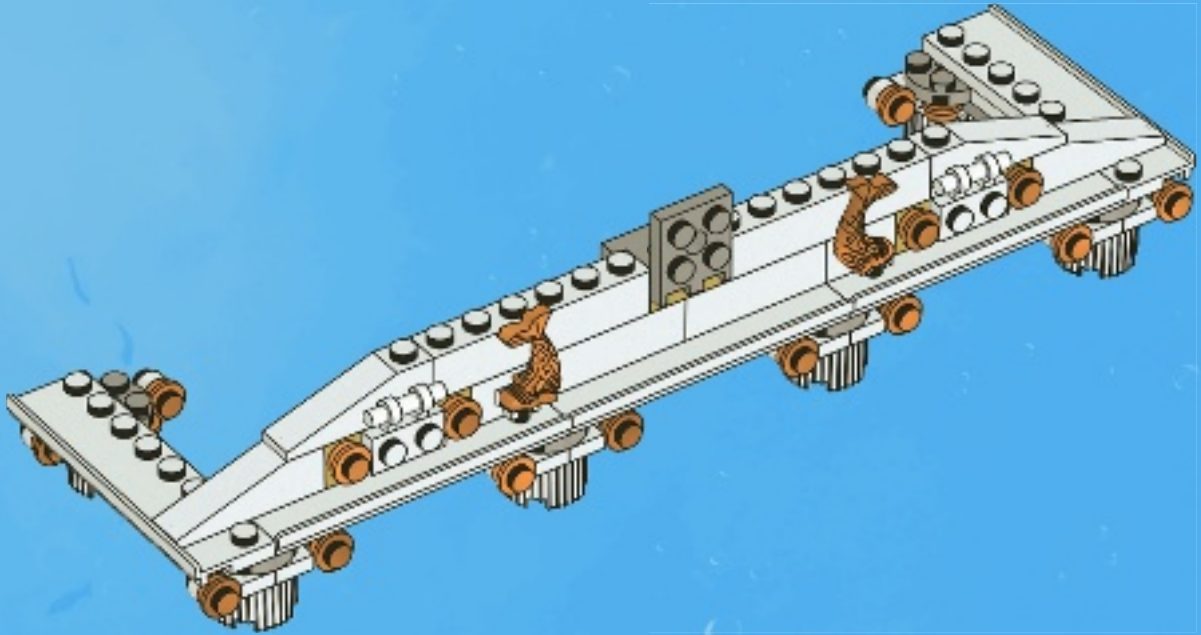

1x



2x



2x



2x

13

1



2

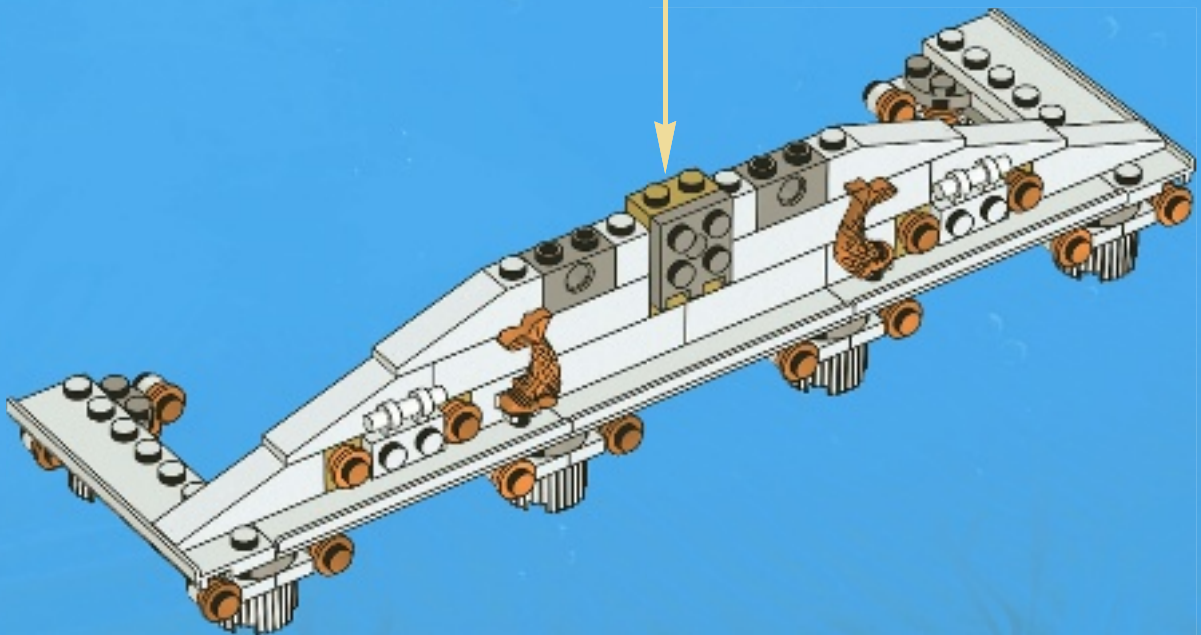
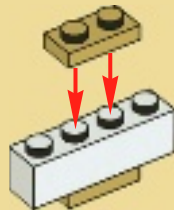



2x

14

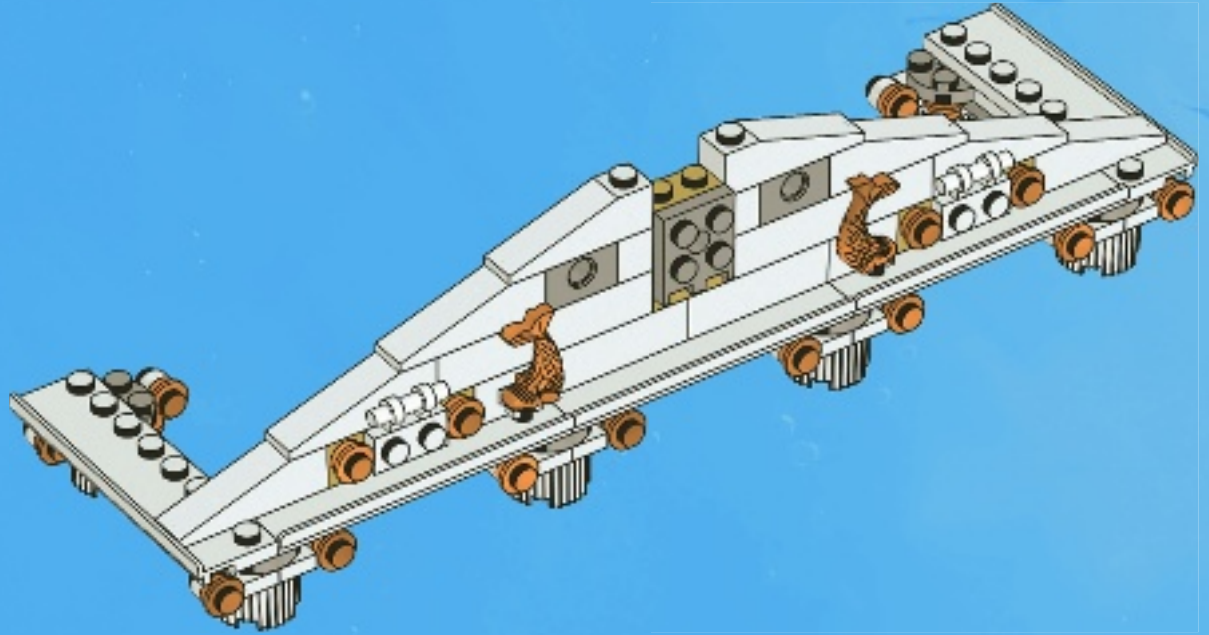

1x



1x



1x

15

1

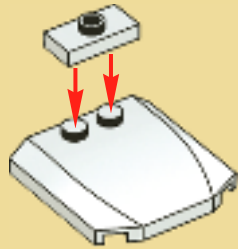

2

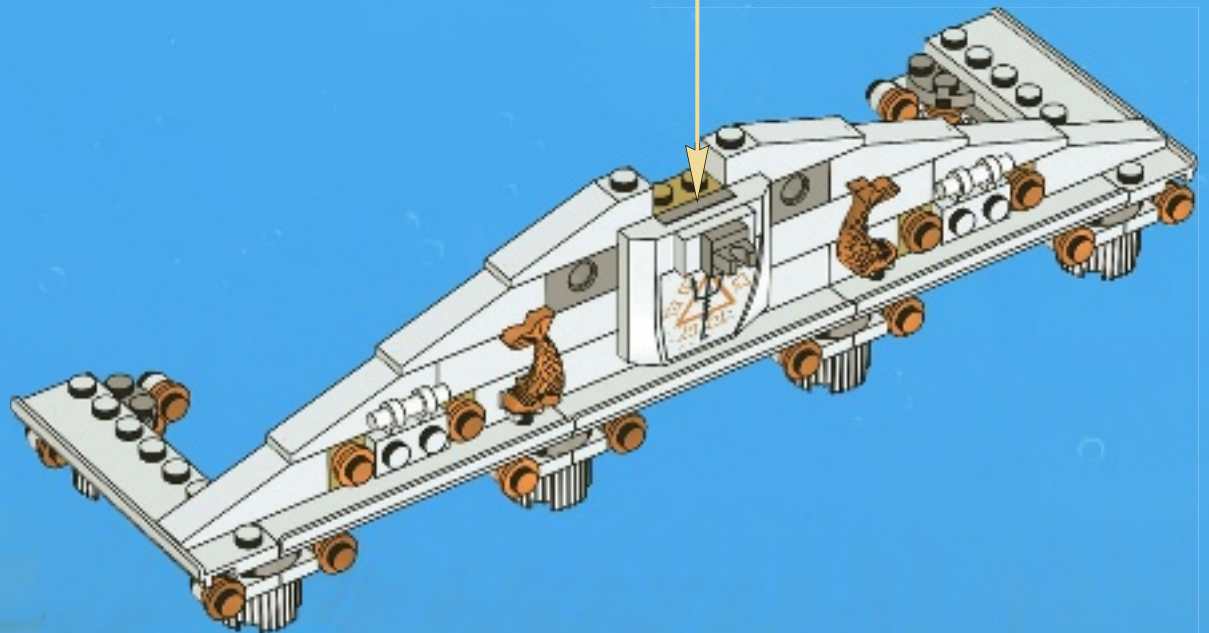
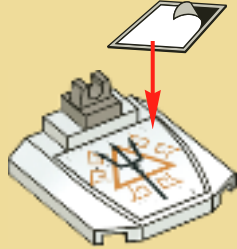



16

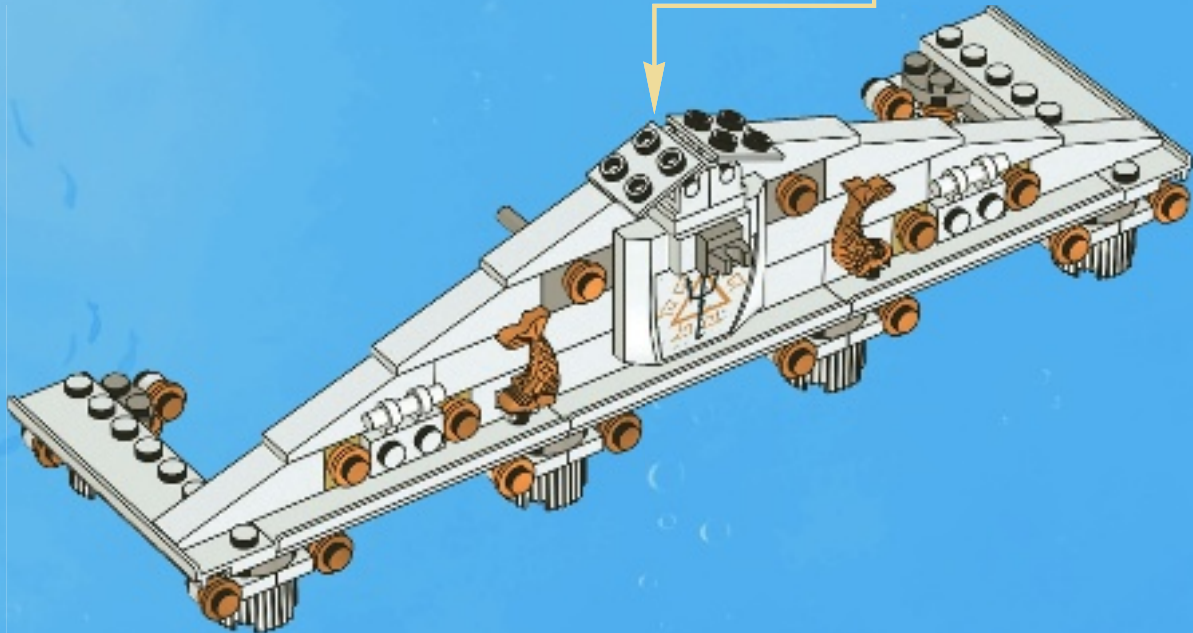
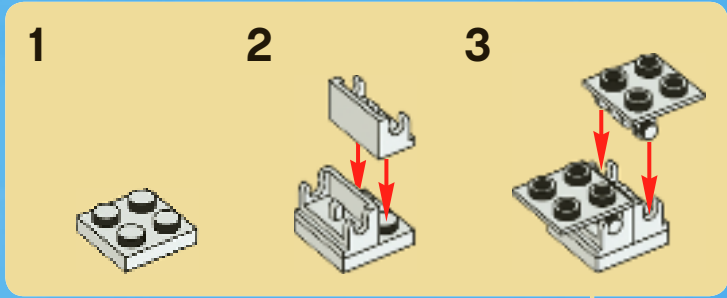

28

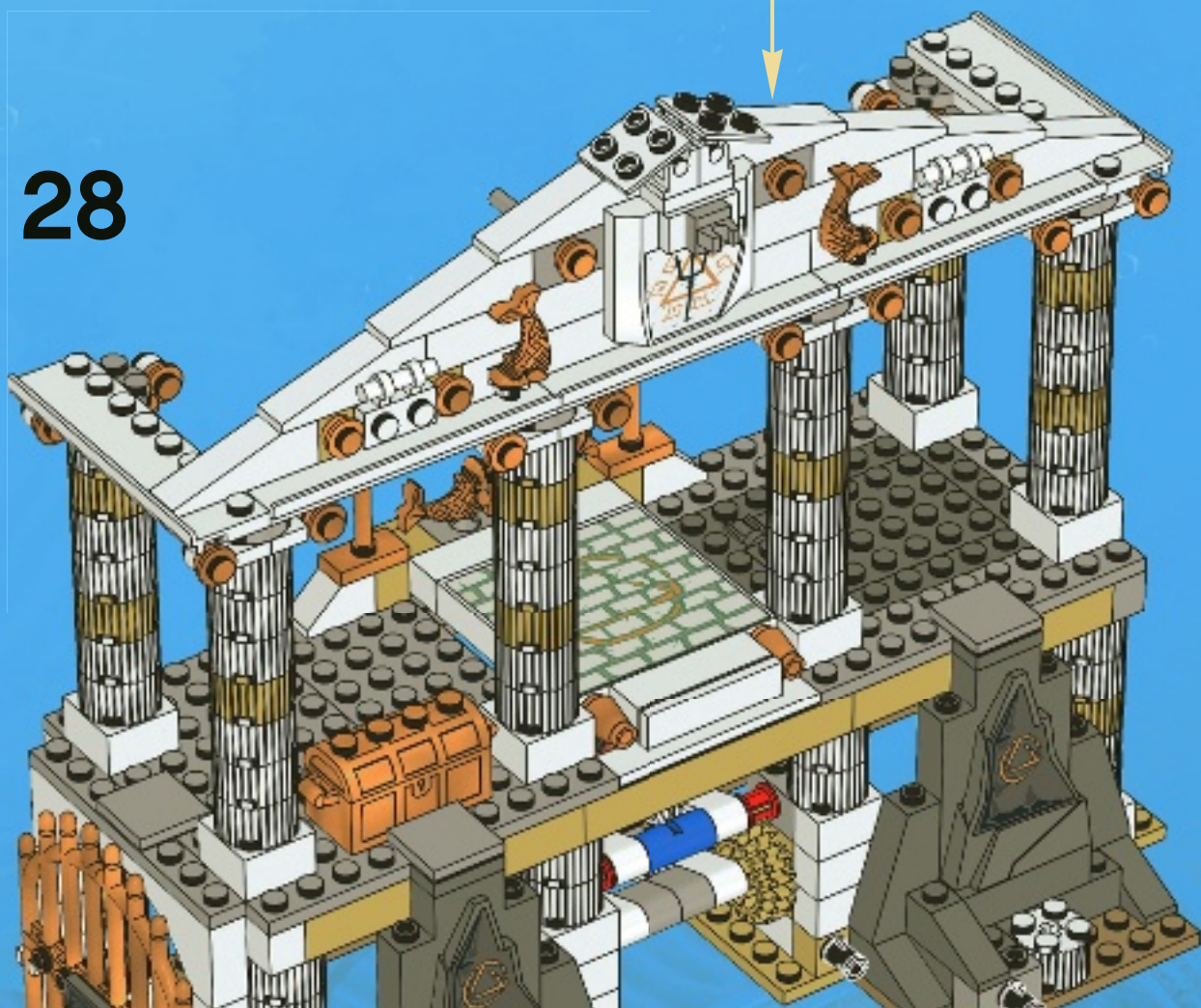

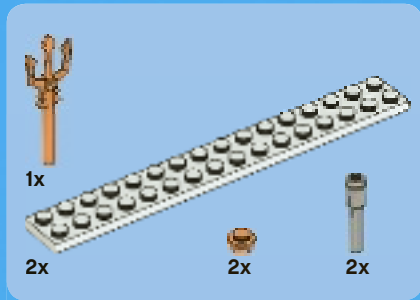

29

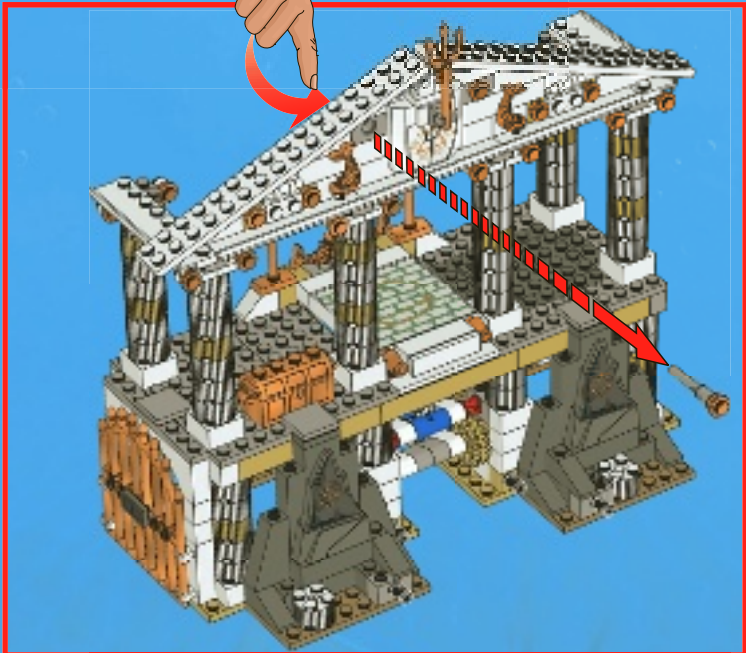
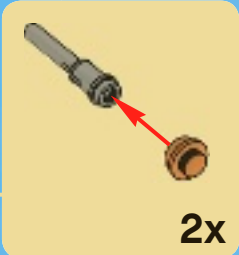
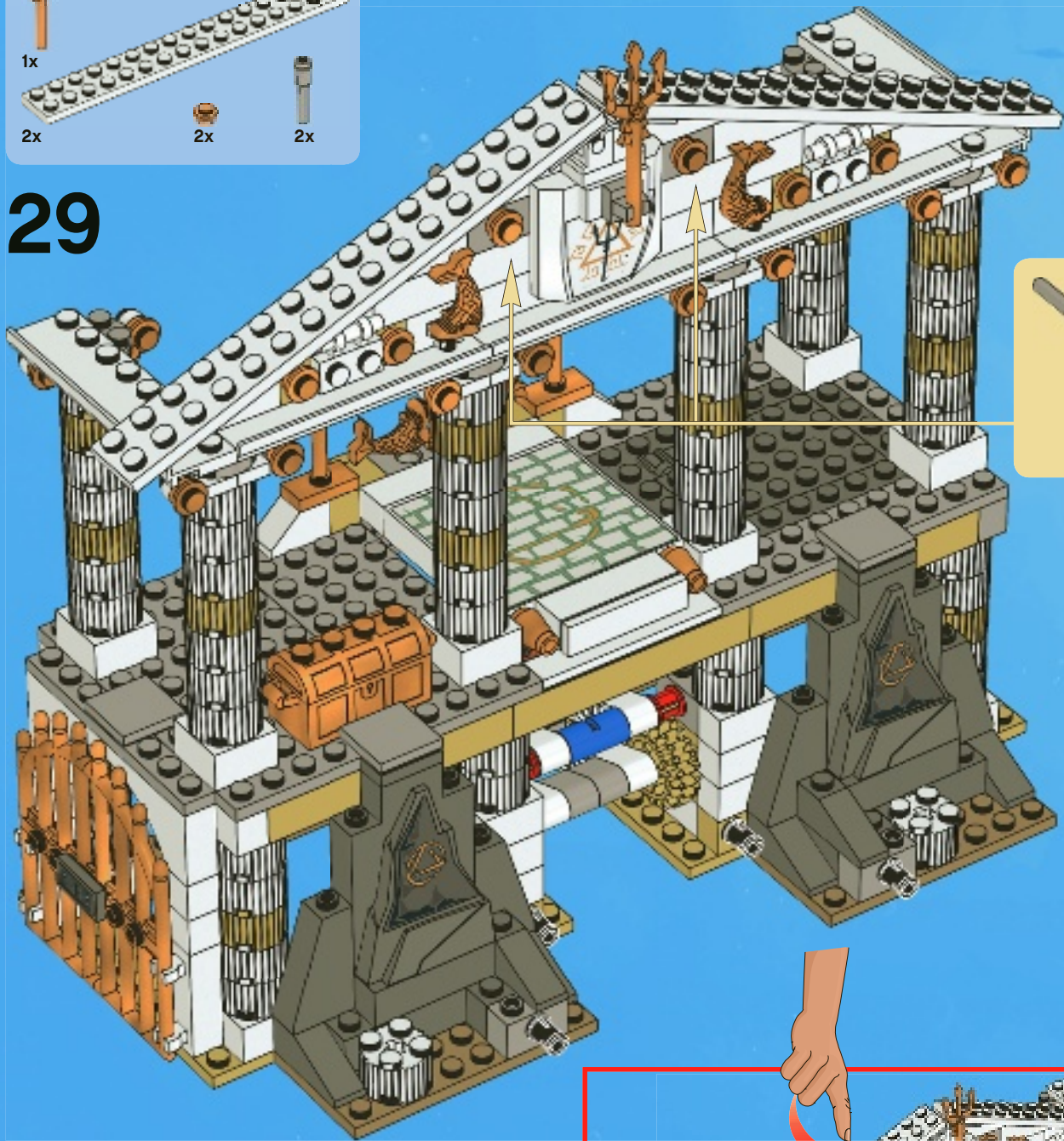

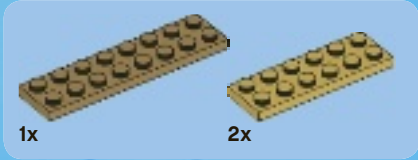

1

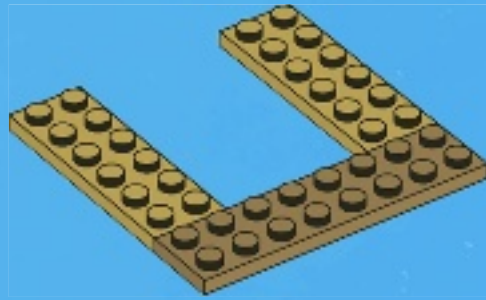

2



3

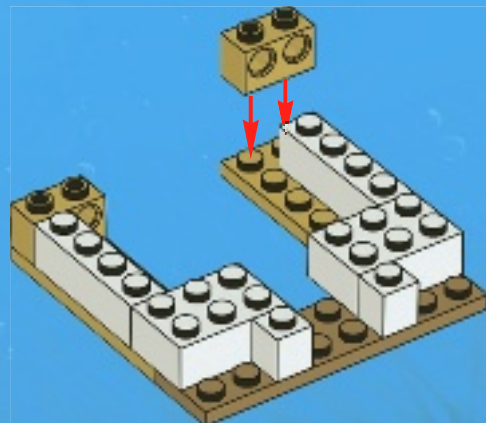



4

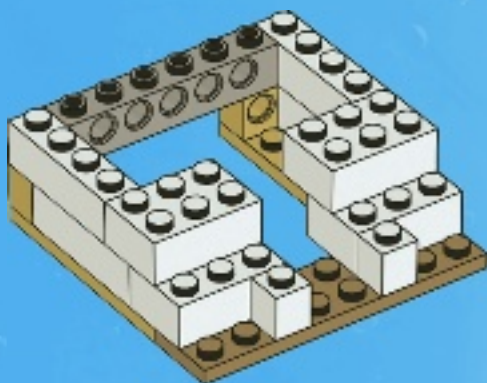

5

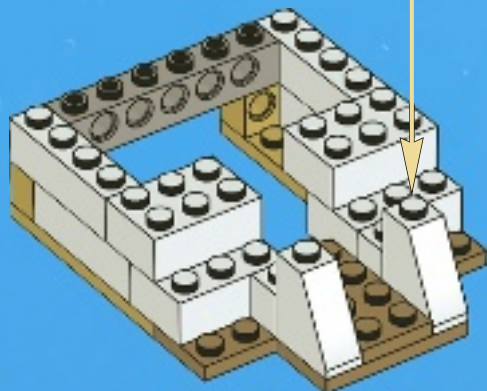
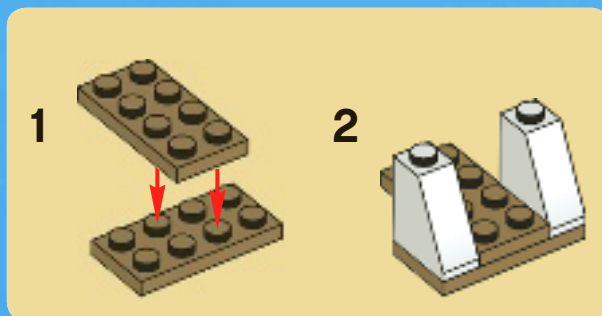



1:1



1



1x



2

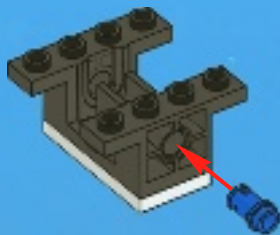

1x



1x

3

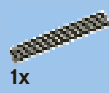
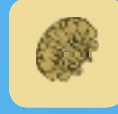

1x



1x

4



1x

5





1x

6

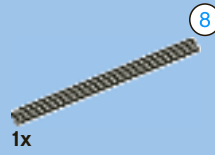

1x



1x

8

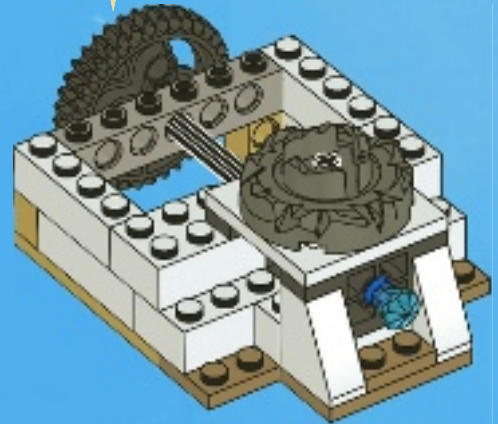
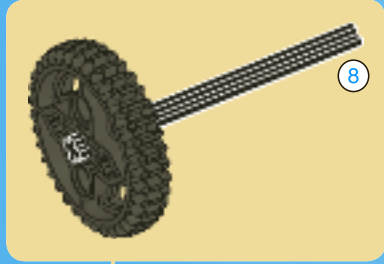

7

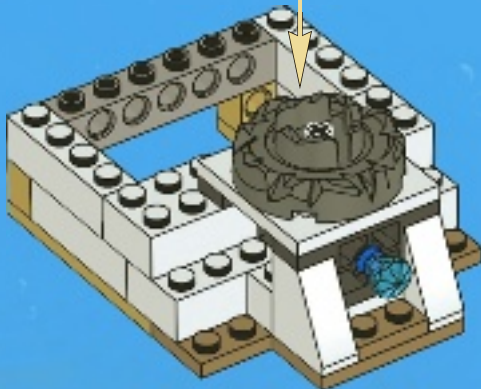

2x



4x

9

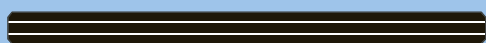
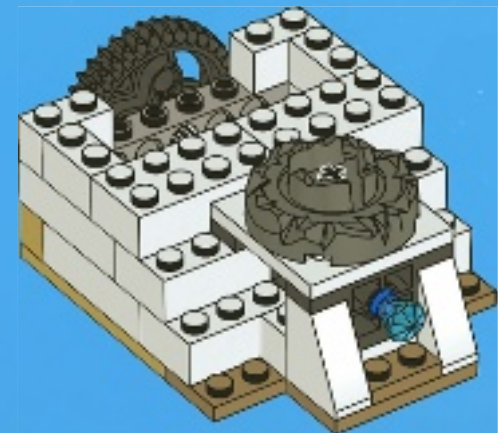

8

1:1



2x



2x

10



2x

12

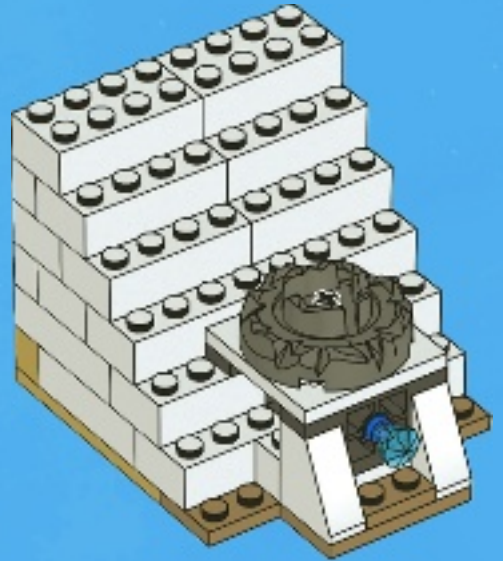

2x



2x

11

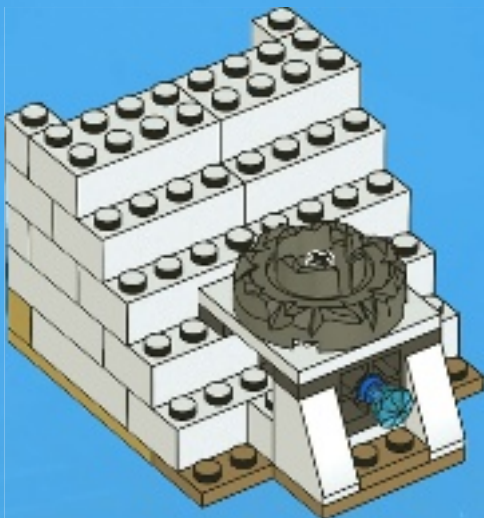

1x



1x

13

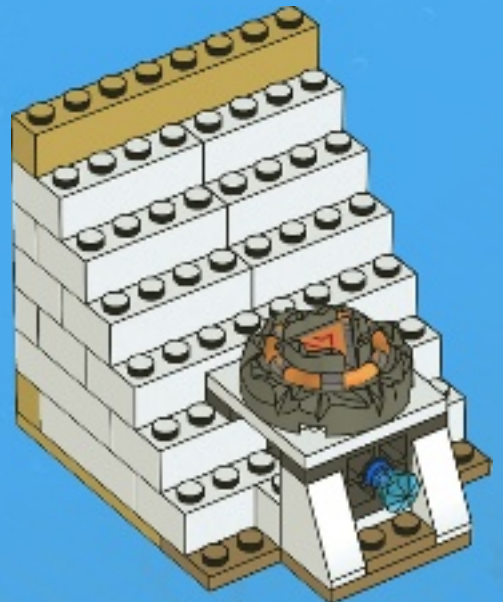

30





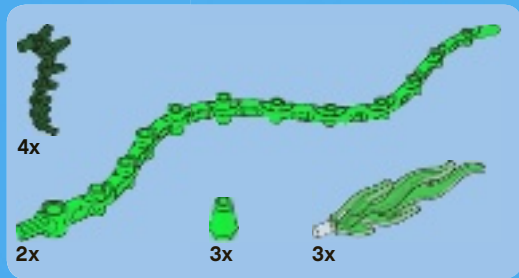
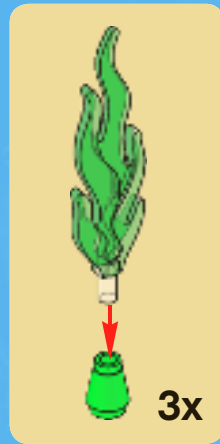
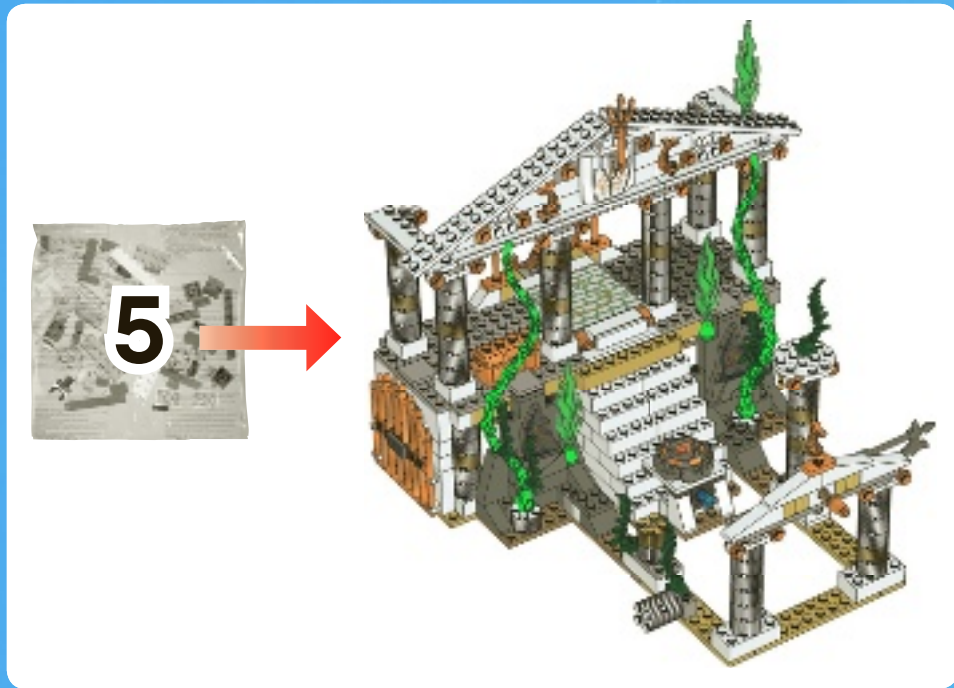

31

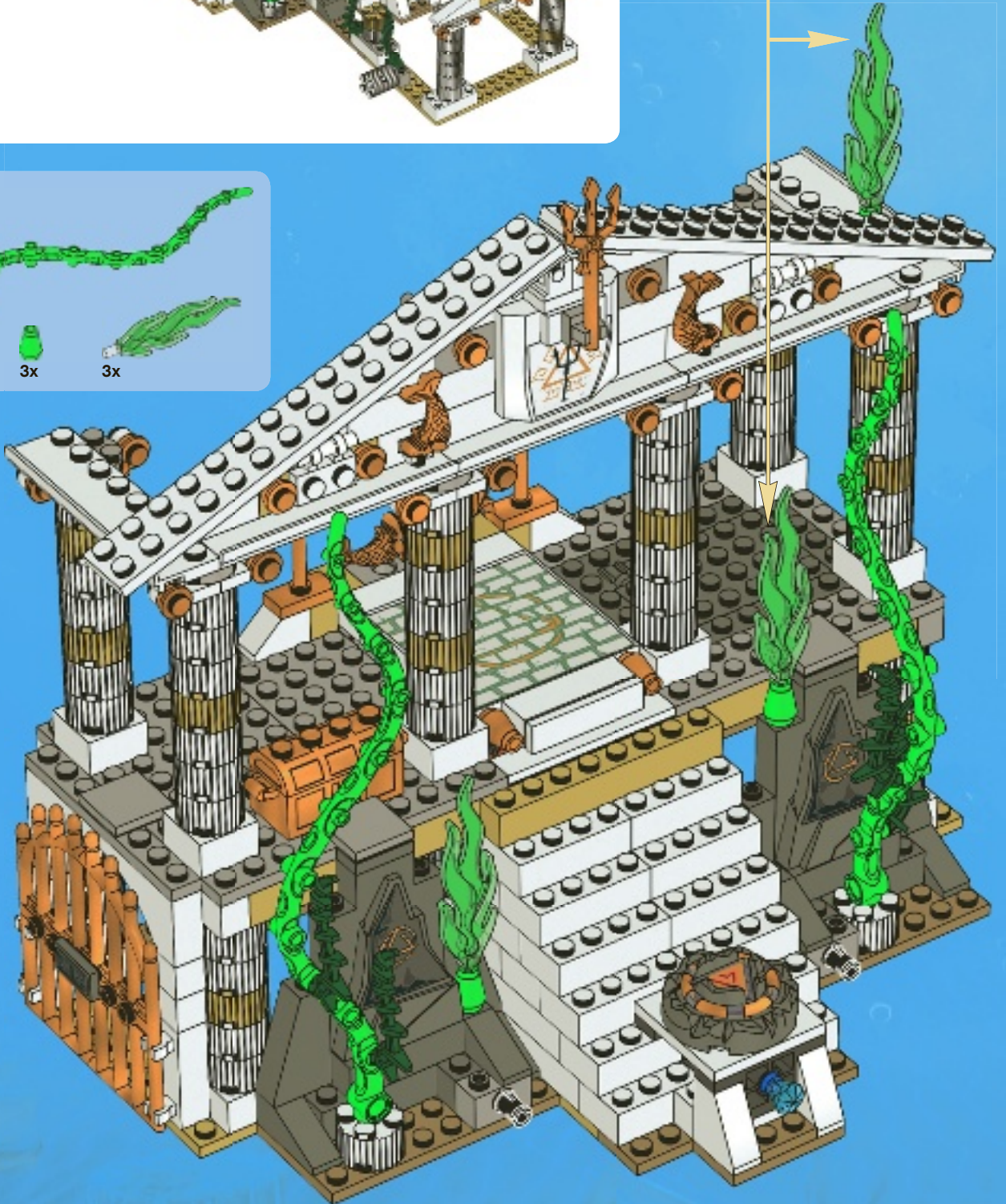

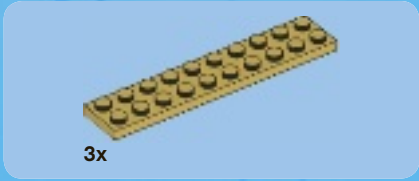

3x

1

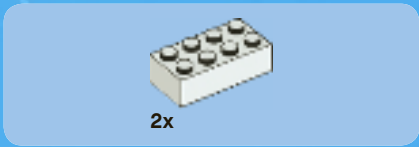
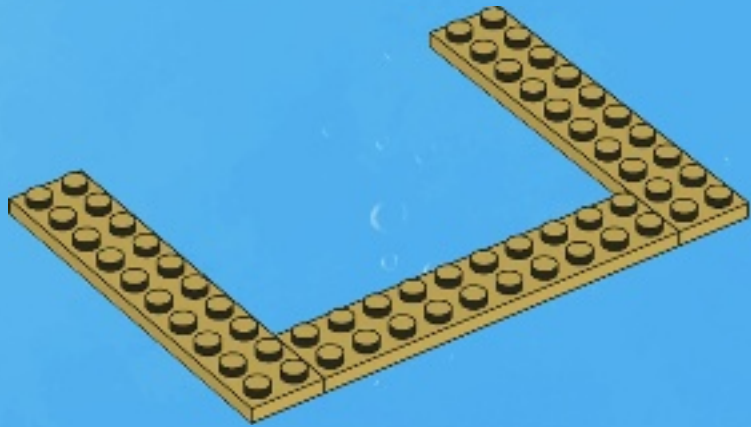

2x

2

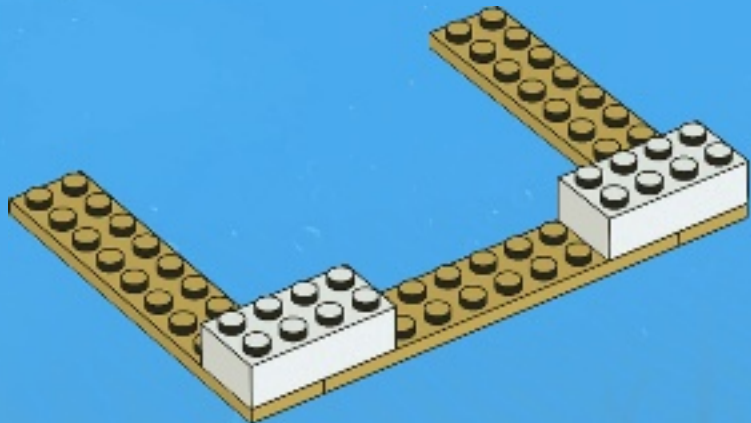

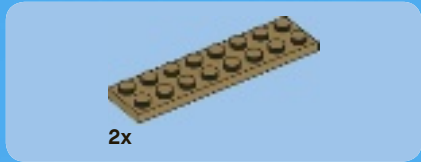

3

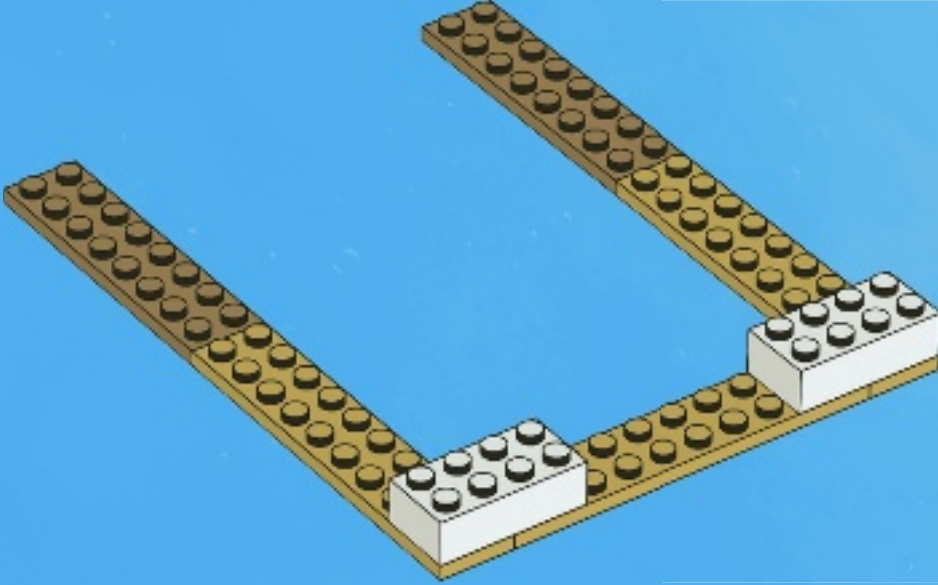

4

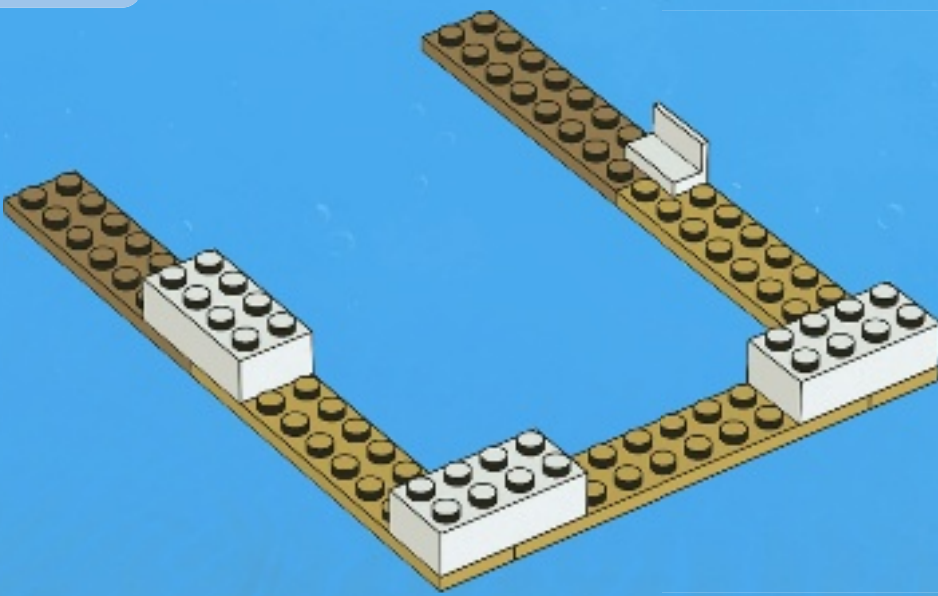



2x



2x

5

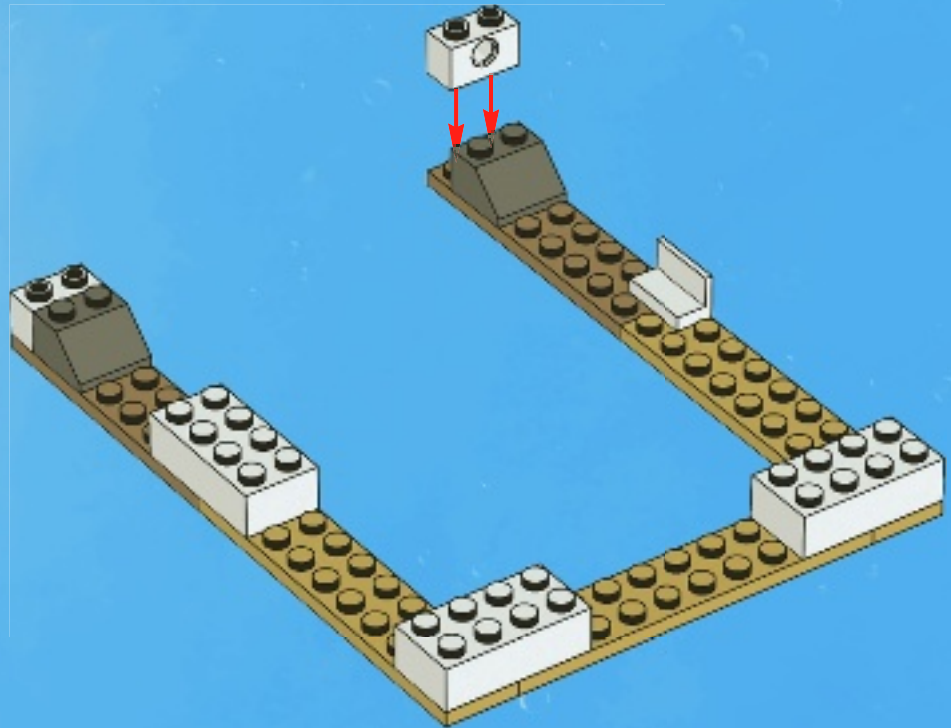

2x



2x



1x

6

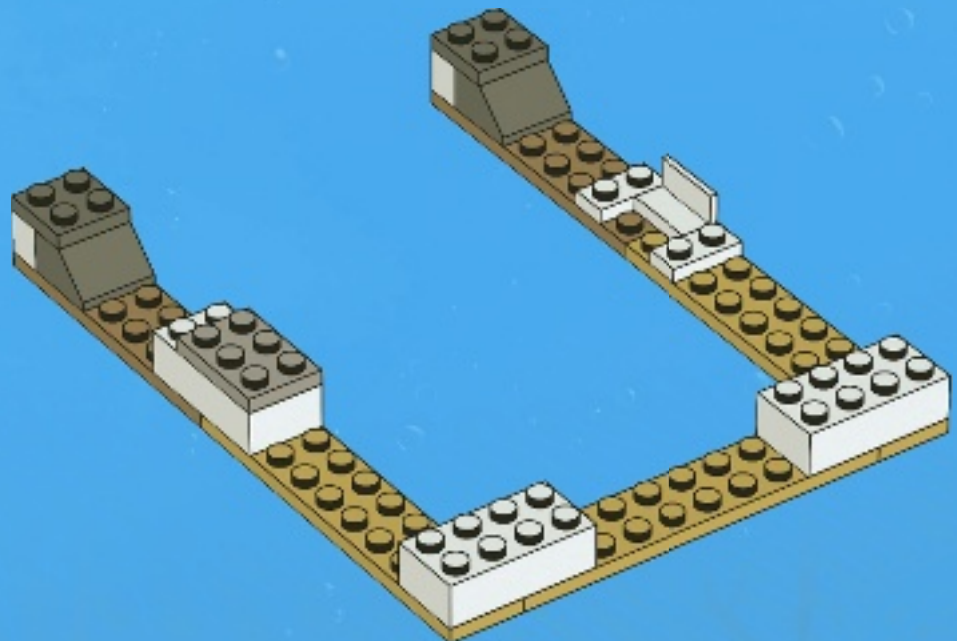



7

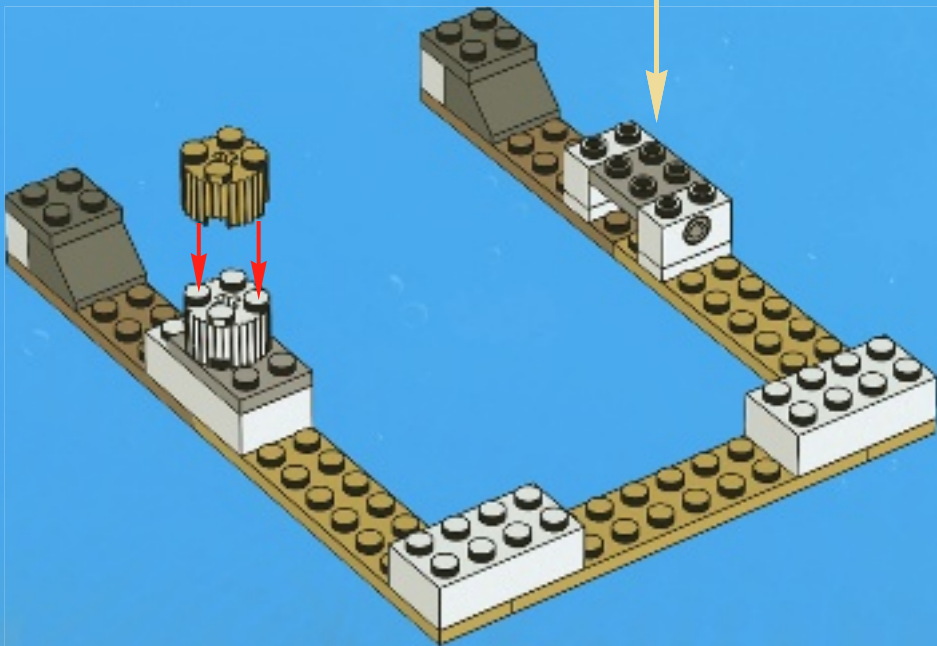
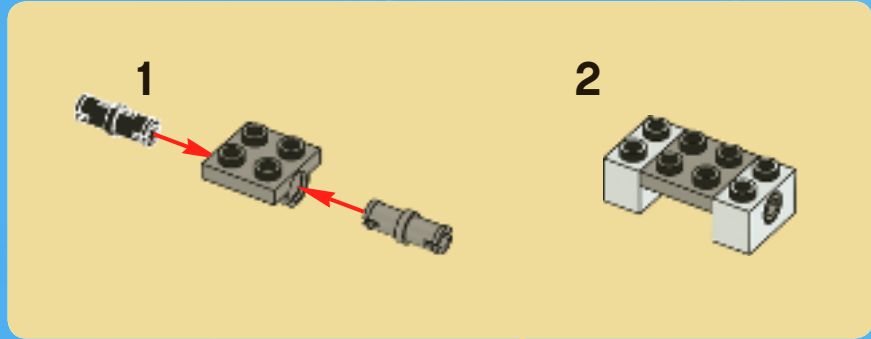

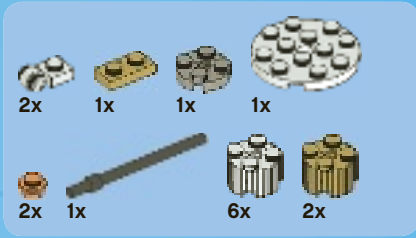

8

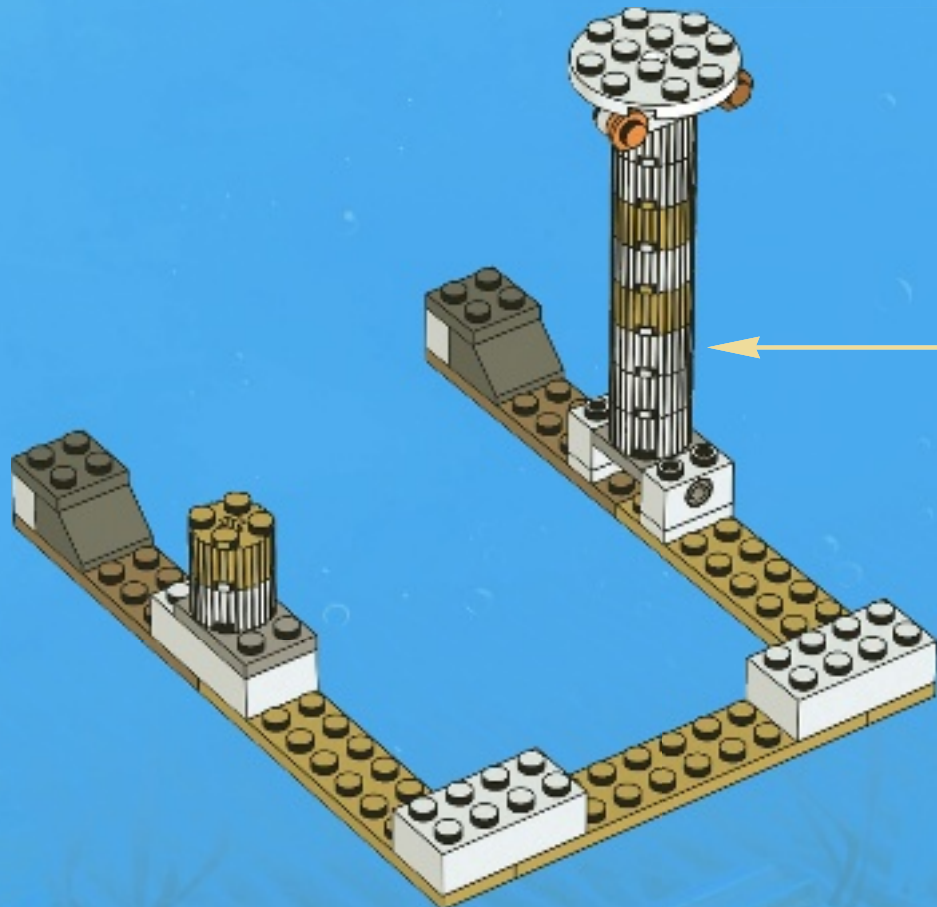
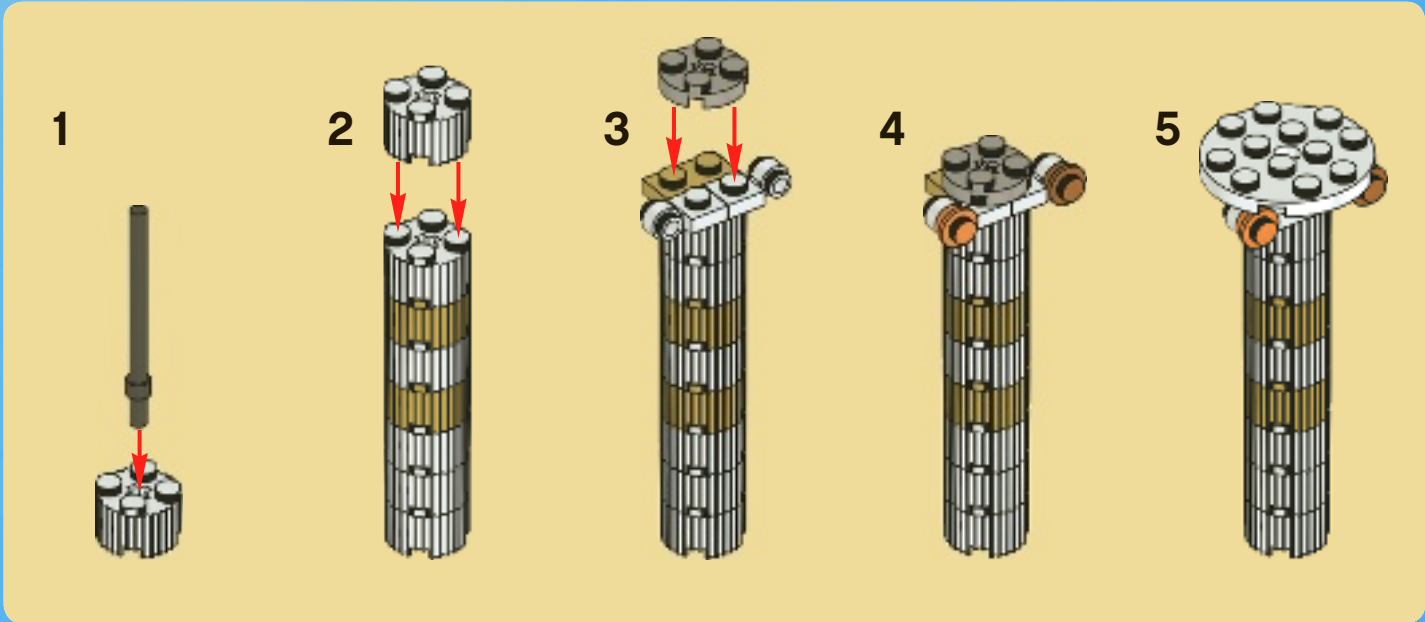

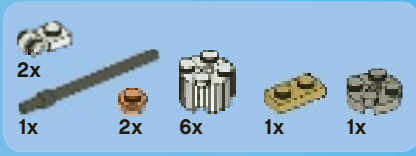

12

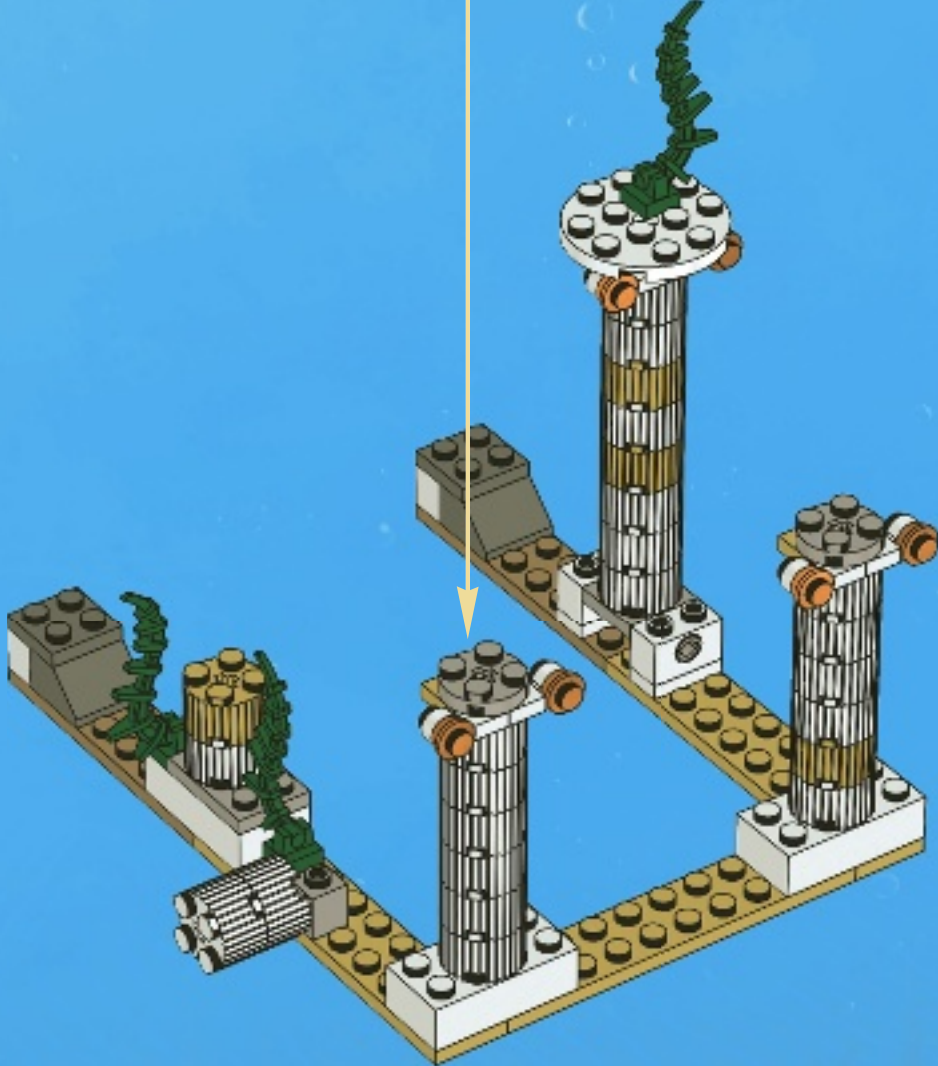
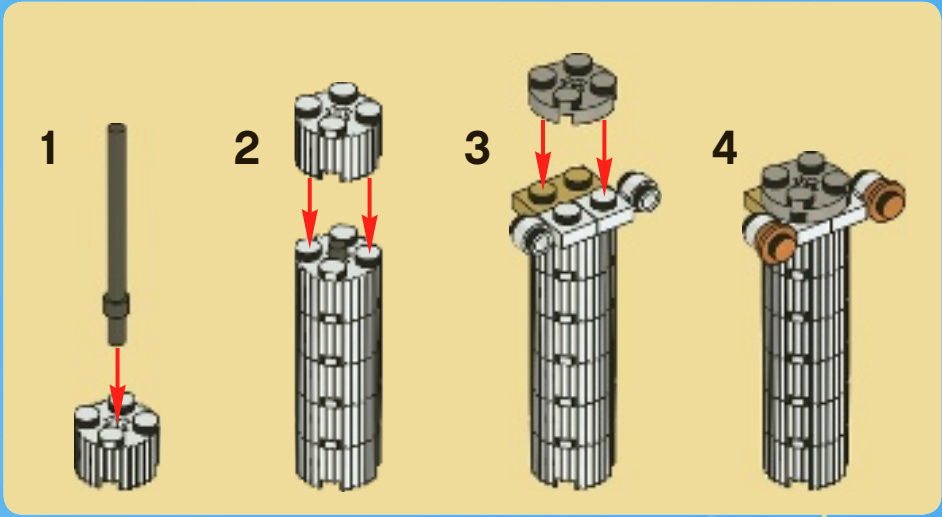

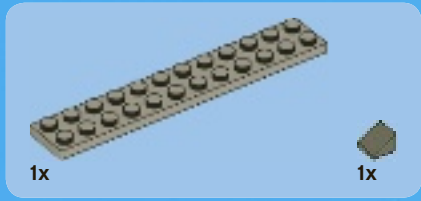
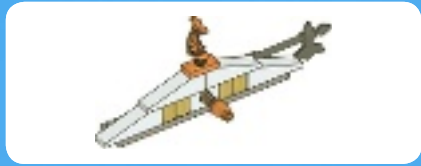

1

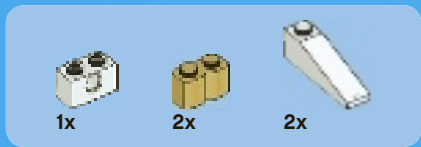
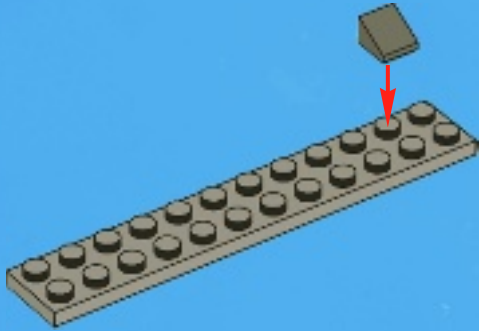

2

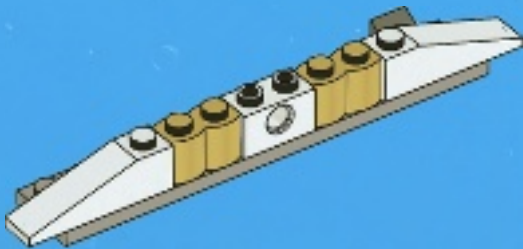

3



4

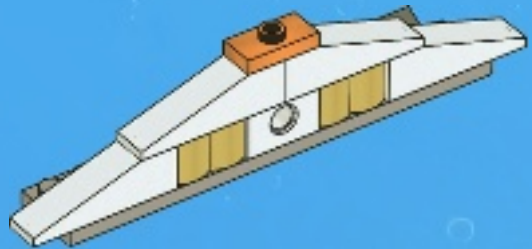

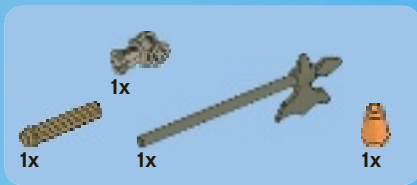

5

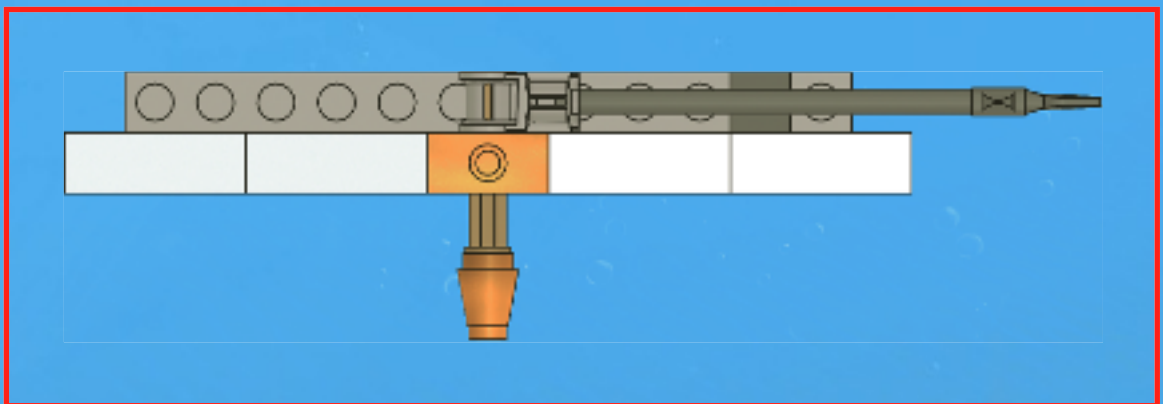
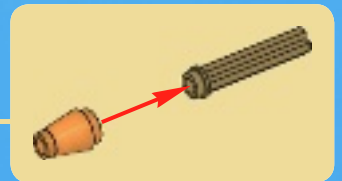
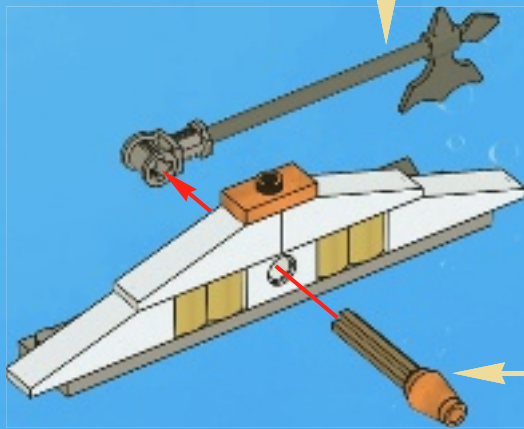
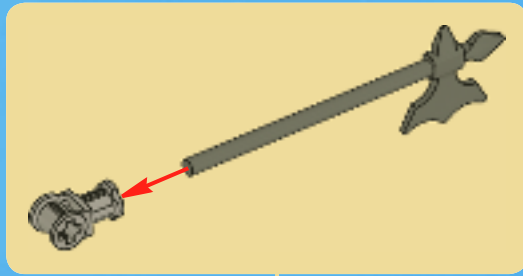



1x

6

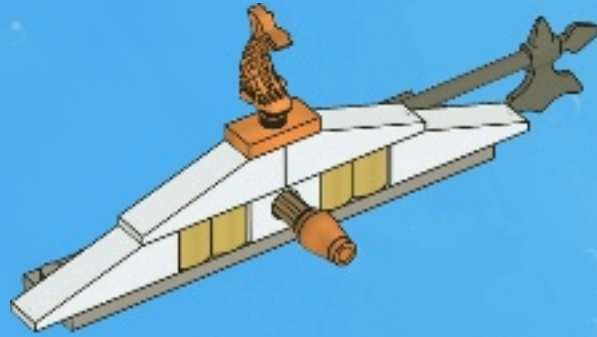

13



32

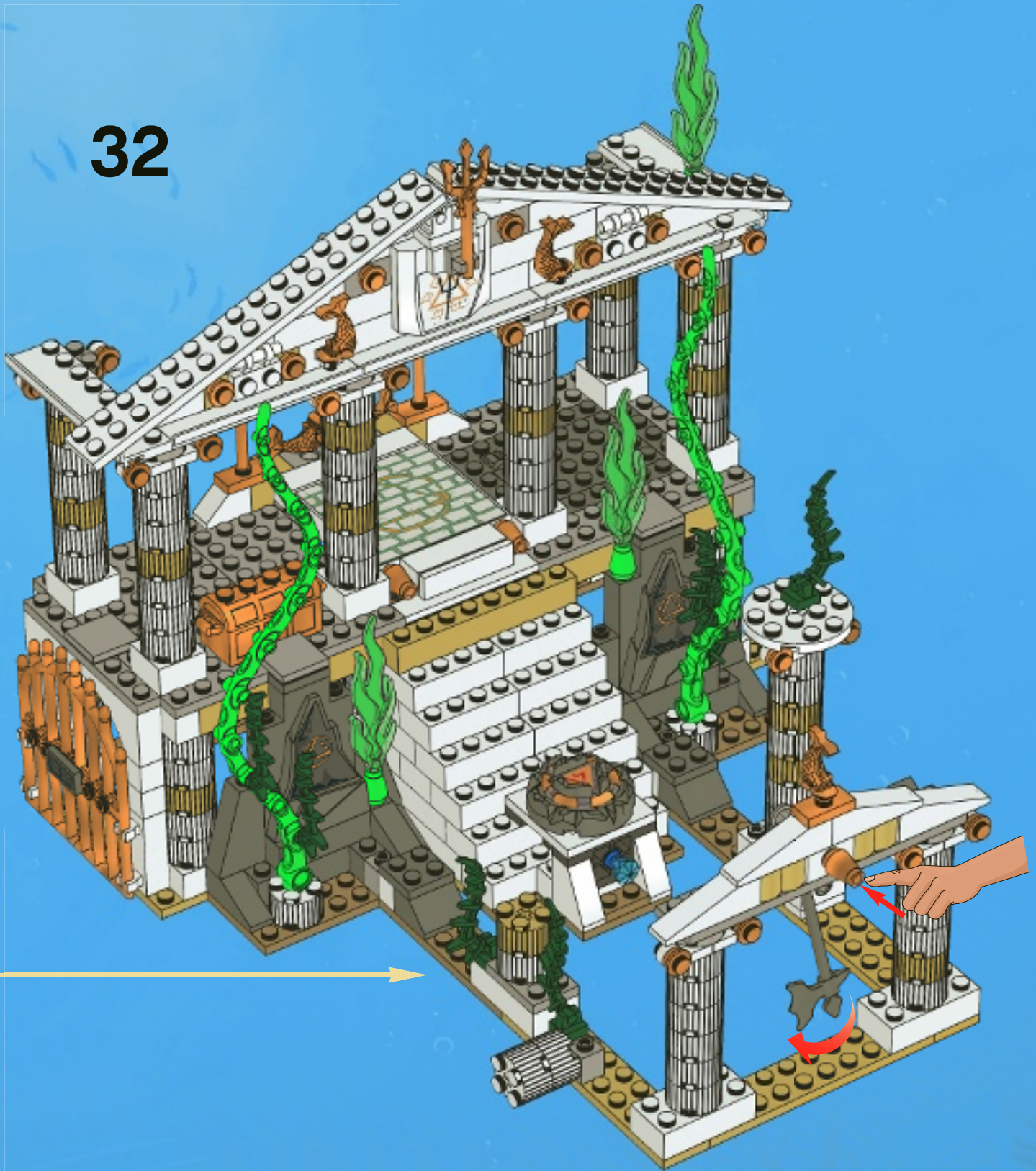



7976

7984

7978

7985

7977





7977



7976



7978



7985



7984



2x 419227
 1x 4547489
 2x 4121932
 1x 303901
 12x 4515359
 8x 300501
 2x 302301
 1x 302201
 1x 243101
 2x 371001
 1x 663601
 18x 408101
 1x 379401
 2x 4140583
 1x 370901
 1x 4515347
 2x 4515370
 2x 4117061
 2x 4568387
 1x 4193068
 2x 4119227
 1x 4504228
 1x 4160736
 5x 4500878
 3x 346001
 1x 611101
 3x 300901
 6x 300401
 12x 300301
 8x 235701
 4x 300201
 8x 301001
 11x 300101
 2x 4563684
 1x 486501
 83x 4603123
 5x 370001

2x 393701
 2x 4612342
 1x 4611927
 4x 4495927
 7x 4249019
 6x 4159774
 2x 4218749
 2x 4201062
 19x 4612717
 4x 4179771
 4x 4523145
 14x 4113917
 2x 4113993
 3x 4186017
 2x 4565452
 1x 4514555
 1x 300121
 1x 4513987
 4x 4504379
 2x 4612342
 1x 4611927
 4x 4495927
 7x 4249019
 6x 4159774
 2x 4218749
 2x 4201062
 19x 4612717
 4x 4179771
 4x 4523145
 14x 4113917
 2x 4113993
 3x 4186017
 2x 4565452
 1x 4514555
 1x 300121
 1x 4513987
 4x 4504379

2x 4500462
 8x 4520782
 5x 302321
 2x 302021
 1x 383221
 2x 4603505
 4x 4226876
 1x 281721
 4x 614121
 1x 415021
 2x 4140806
 2x 300723
 2x 366523
 2x 306923
 2x 302223
 3x 4143005
 1x 4595160
 2x 300424
 2x 306224
 1x 4570002
 1x 4549621
 2x 4613918
 2x 4500462
 8x 4520782
 5x 302321
 2x 302021
 1x 383221
 2x 4603505
 4x 4226876
 1x 281721
 4x 614121
 1x 415021
 2x 4140806
 2x 300723
 2x 366523
 2x 306923
 2x 302223
 3x 4143005
 1x 4595160
 2x 300424
 2x 306224
 1x 4570002
 1x 4549621
 2x 4613918

1x 9553
 2x 407026
 2x 4251161
 1x 4219107
 1x 306826
 4x 4517925
 2x 4598528
 2x 4144024
 2x 4604304
 1x 4561035
 3x 4538722
 6x 4623154
 1x 4587501
 8x 4563477
 2x 4153044
 1x 4500902
 13x 4121715
 1x 370526
 2x 370726
 1x 4255563
 3x 4529239
 1x 4248937
 3x 4615113
 1x 3005741
 4x 4497943
 1x 4113954
 2x 4119483
 6x 3005744
 2x 4611109
 1x 4611686
 1x 3005748
 4x 4504371
 1x 4158355
 4x 4614380
 2x 4570396
 2x 4267874
 5x 4246957
 2x 4251796
 1x 4566927
 5x 4612418
 9x 4294148

4

8



2x
4612416

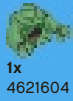

1x
4621604



1x
4206504



1x
4599743

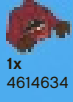

1x
4614634



1x
4600086

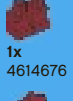

1x
4614676

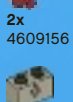

2x
4609156

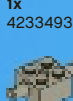

1x
4233493

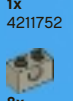

1x
4211752



8x
4211440



3x
4211441



1x
4211466



1x
4211374



3x
4211413



1x
4211396



7x
4211438



3x
4211425



2x
4211462



1x
4211402



1x
4211360



1x
4211405



1x
4211369



4x
4594238



1x
4211376



1x
4211472



9x
4211475



2x
4613550



4x
4520320



2x
4515184



3x
4211622



3x
4211807



1x
4211553



1x
4211815



4x
4211085



2x
4211044



4x
4497253



1x
4504378



4x
4221745



2x
4211054



1x
4211000



6x
4211045

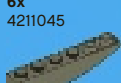

2x
4210779



2x
4211063



1x
4211052



2x
4211094



1x
4211043



3x
4211065



2x
4210763



2x
4211069



2x
4611703



4x
4277928



2x
4210660



1x
4211129



4x
4521187



1x
4595710



1x
4595708



4x
4278274



2x
4527082

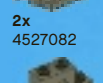

2x
4513326



2x
4614153



2x
4614155

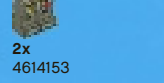

1x
4222798



1x
4567411



4x
4294289



1x
4563480



2x
4598409



1x
4560177



3x
4529247



3x
4523157



1x
4615902



28x
4523159



2x
4566967



1x
4541394

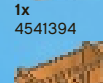

1x
4541393



1x
4614639



1x
4621479



1x
4616270



1x
4600271



6x
4595077



5x
4609212



1x
4614679



6x
4625564



2x
4613444



1x
4611885

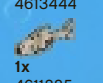

2x
4612827



Customer Service

Kundenservice

Service Consommateurs

Servicio Al Consumidor

www.lego.com/service or dial



00800 5346 5555 :



1-800-422-5346 :



LEGO club™

FREE! GRATIS! GRATUIT!



www.LEGOclub.com



LEGO® Club Magazine



LEGO® Club Email

SIGN UP ONLINE!

www.LEGOclub.com

VISIT THE WORLD'S
BIGGEST LEGO® SHOP!

www.LEGOshop.com

GO TO
www.LEGOclub.com

00800 5346 5555*

1-866-534-6258 • 1-877-518-5346

US & Canada only

Canada seulement



* Freephone. Mobile charges may apply. * Numéro sans frais. Des frais peuvent s'appliquer avec les téléphones cellulaires. * Gebührenfrei, Kosten für Anrufe aus Mobilfunknetzen können abweichen. * Gratis telefoonnummer vanaf vaste lijn. * Det er et gratis nummer, når du ringer fra fasttelefon. * Det är gratis, när du ringer från en fast telefon. * Numéro sans frais. Des frais peuvent s'appliquer avec les téléphones portables.



WIN!

Go to www.LEGOsurvey.com/product to fill out a survey for a chance to win a cool LEGO® Product. No purchase necessary. Open to all residents where not prohibited.

 www.LEGO.com



www.LEGOsurvey.com/product

GEWINNE!

Nimm an der Umfrage auf www.LEGOsurvey.com/product teil und hab die Chance ein cooles LEGO® Produkt zu gewinnen!
Die Teilnahme am Gewinnspiel führt zu keinerlei Kaufverpflichtungen. Teilnahme in allen nicht ausgeschlossenen Ländern möglich.

4624975/ 4624976

WIN!

Ga naar www.LEGOsurvey.com/product, vul een enquêteformulier in en maak kans op een cool LEGO® product.
Geen aankoopverplichting.
Iedereen mag deelnemen, uitgezonderd ingezetenden van landen waar een enquêteverbod geldt.

GAGNE !

Visite www.LEGOsurvey.com/product pour répondre à un questionnaire et avoir une chance de gagner un produit LEGO® très cool !
Aucune obligation d'achat.
Ouvert à tous les résidents des pays autorisés.

当てよう!

www.LEGOsurvey.com/product にアクセスして、アンケートにご記入ください。当選者にはレゴ®製品を差し上げます。
お買い上げの必要はありません。
禁止されていない限り、すべての皆様にご利用いただけます。