



# THE HOBBIT™

AN UNEXPECTED JOURNEY

79003





[LEGO.com/brickseparator](https://LEGO.com/brickseparator)

LEGO THE HOBBIT™  
AN UNEXPECTED JOURNEY

LEGO LE HOBBIT™  
UN VOYAGE INATTENDU

LEGO EL HOBBIT™  
UN VIAJE INESPERADO



1

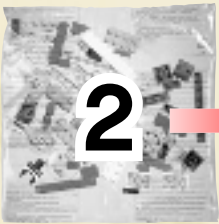
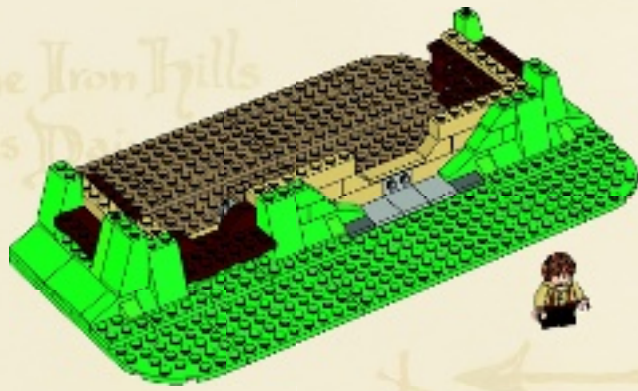

2

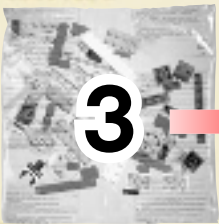
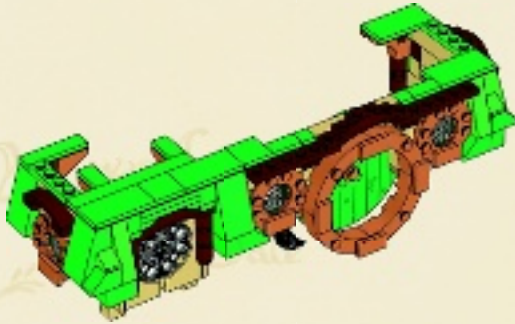

3

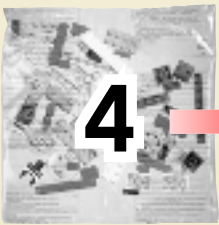

4



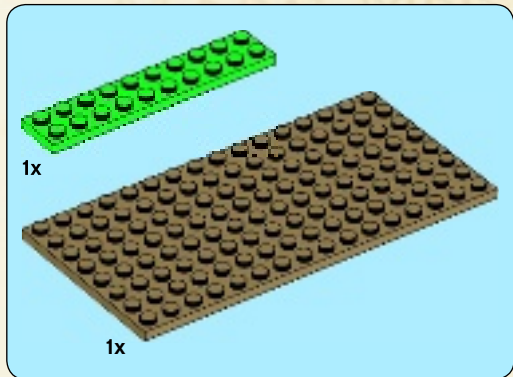
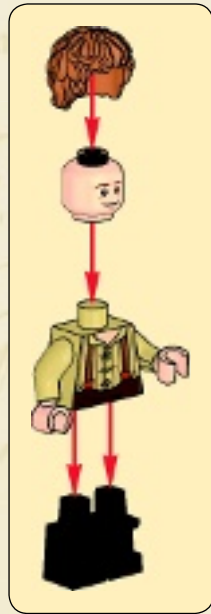
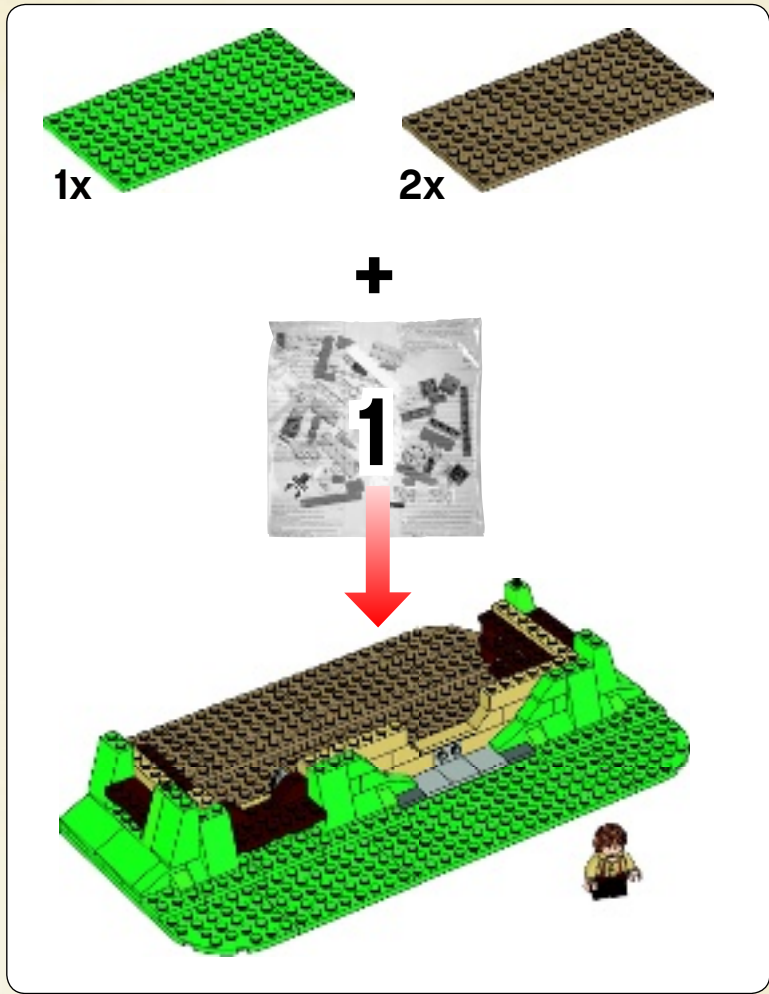

1

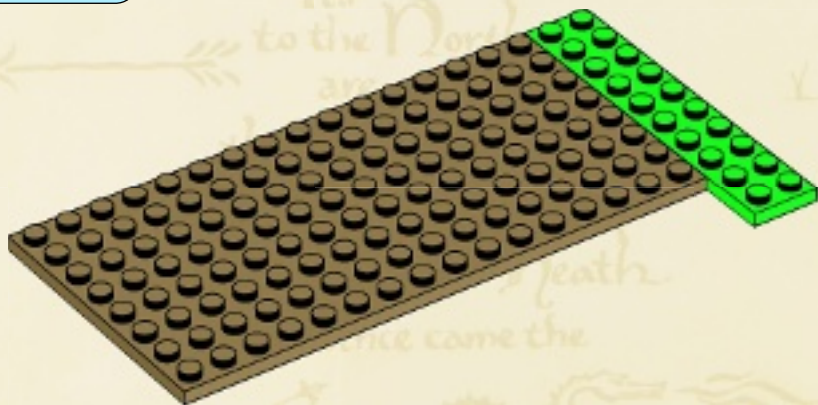

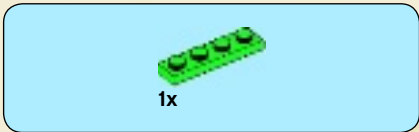

2

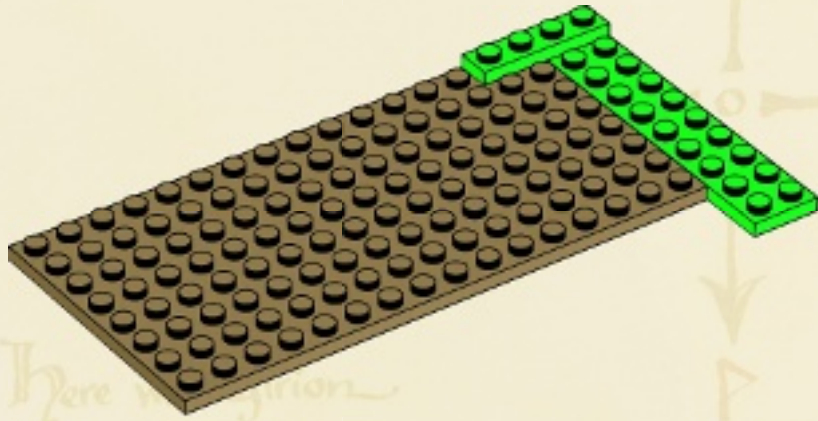

3

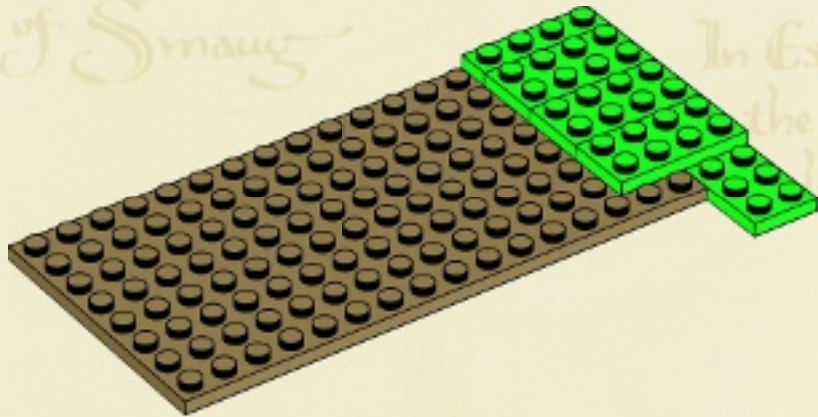



1x

4

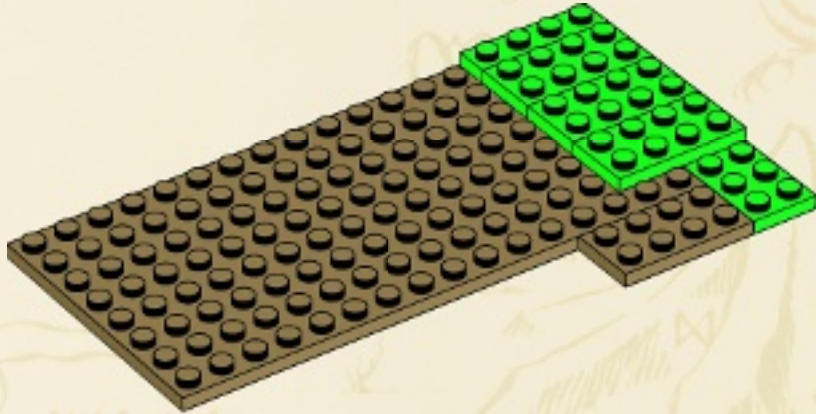

1x

5

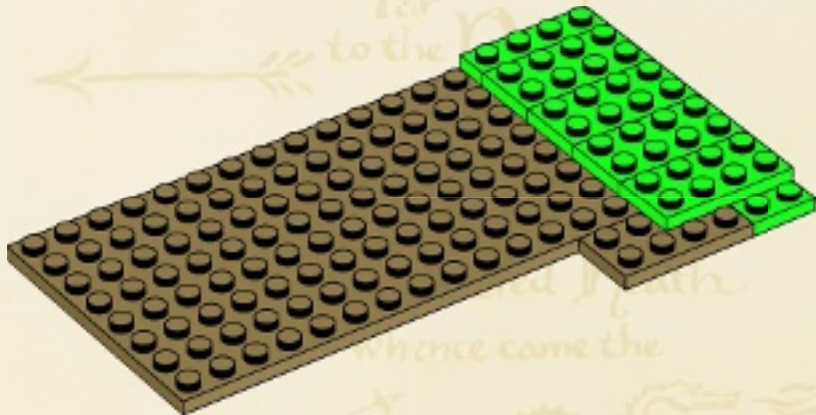

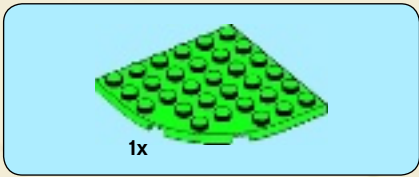

6

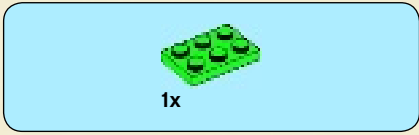
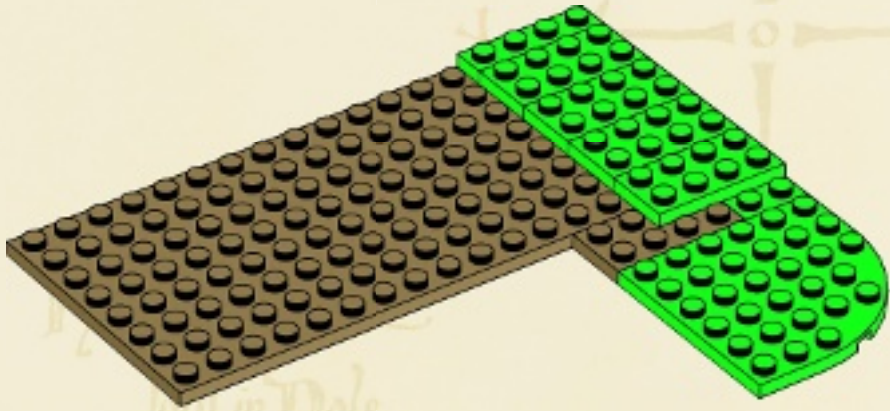

7

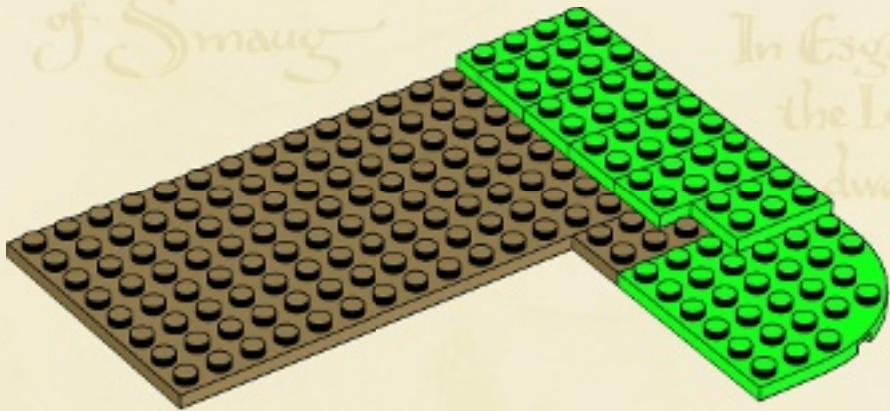

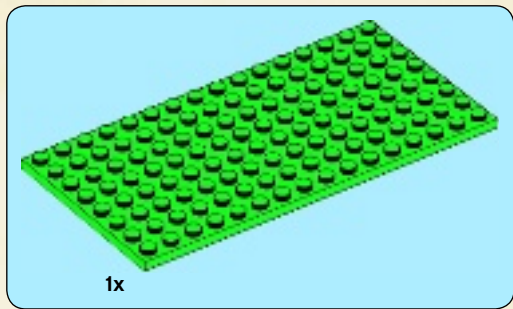

8

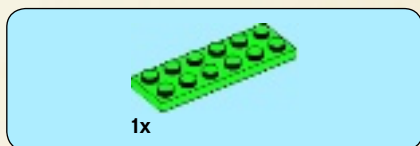
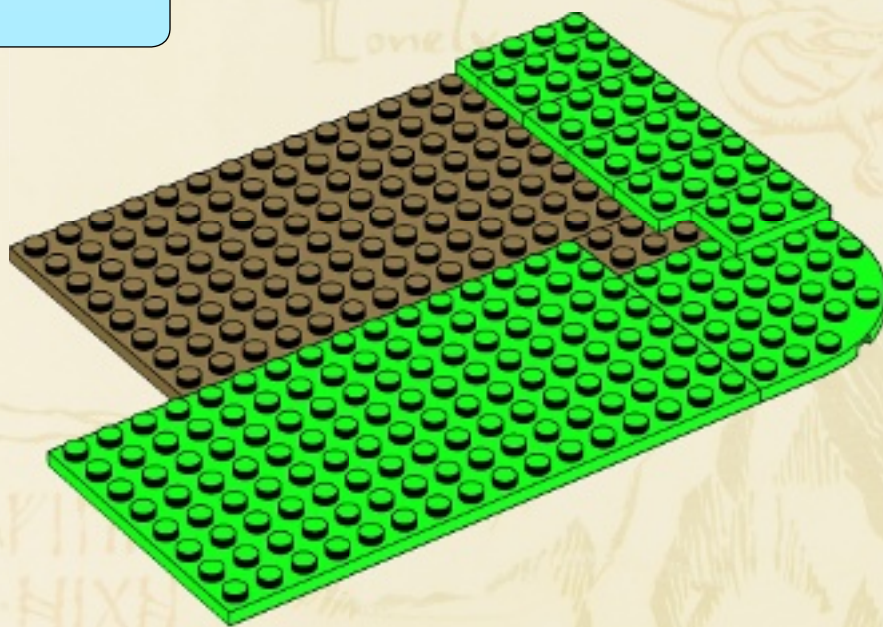

9

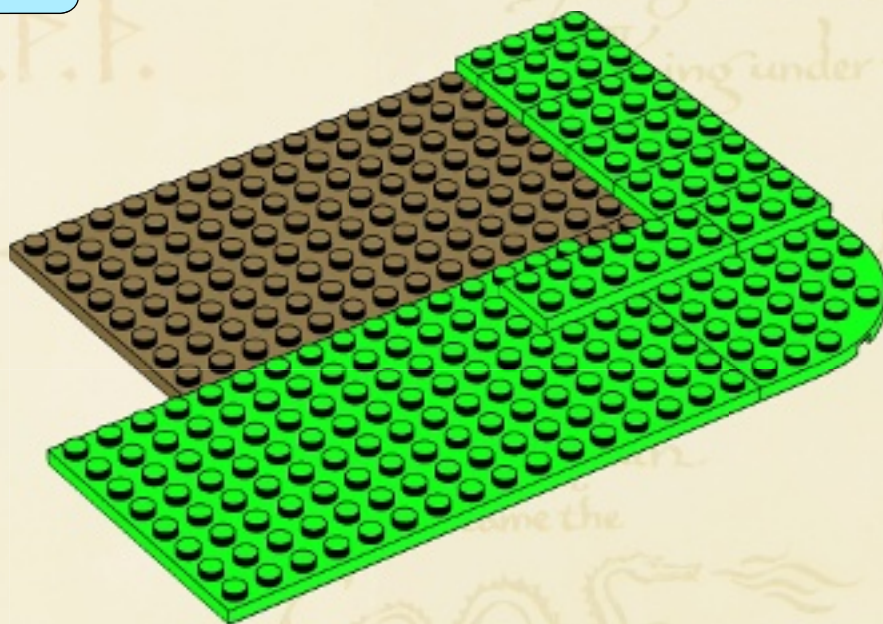



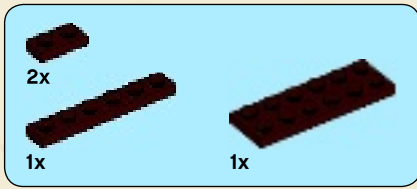

10

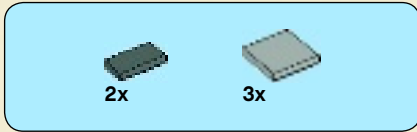
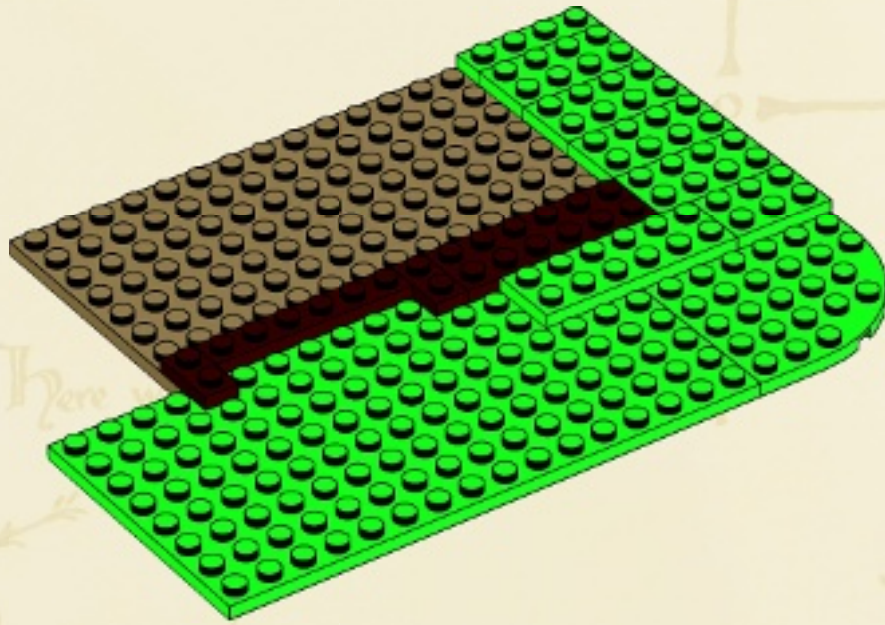

11

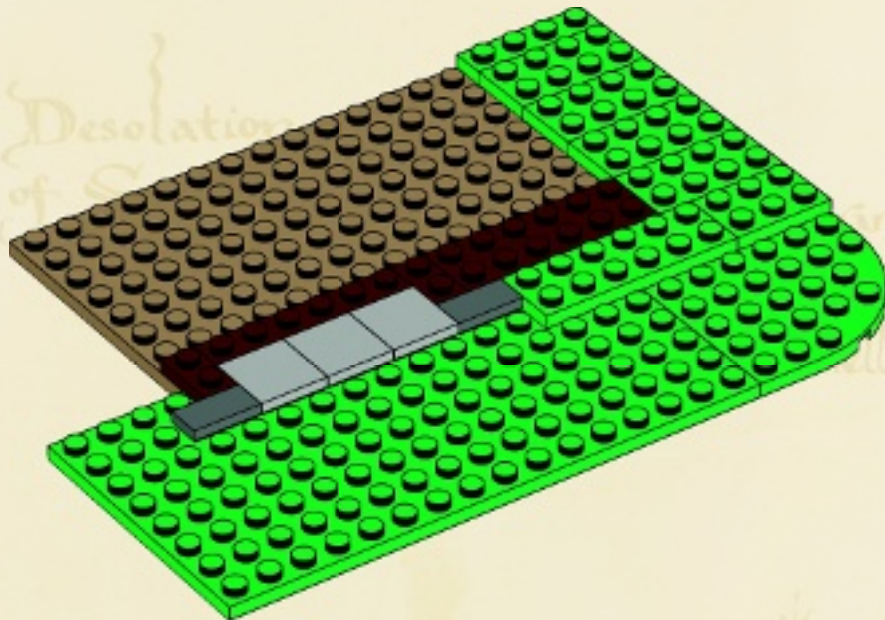

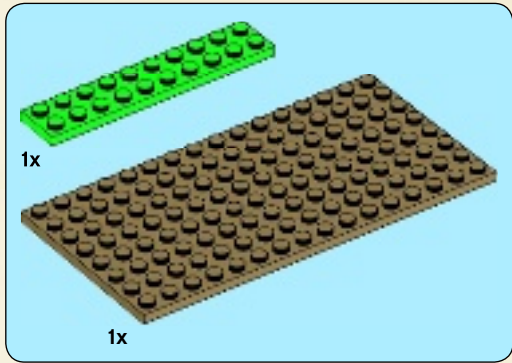
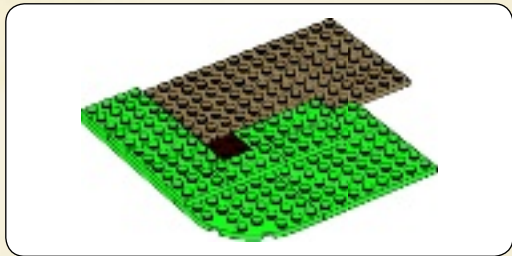

1

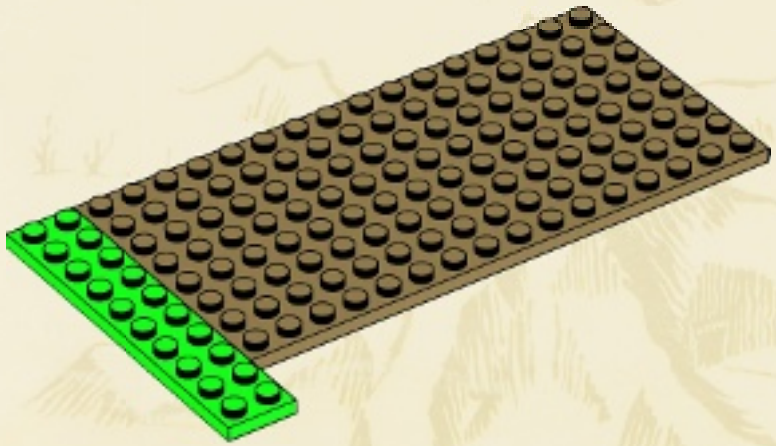

2

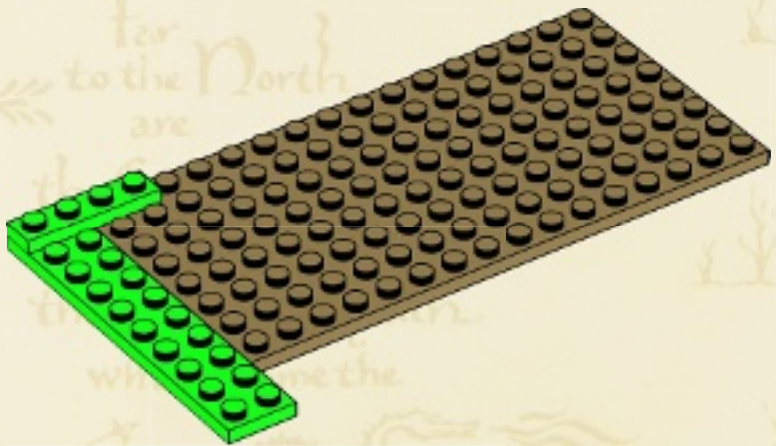



3

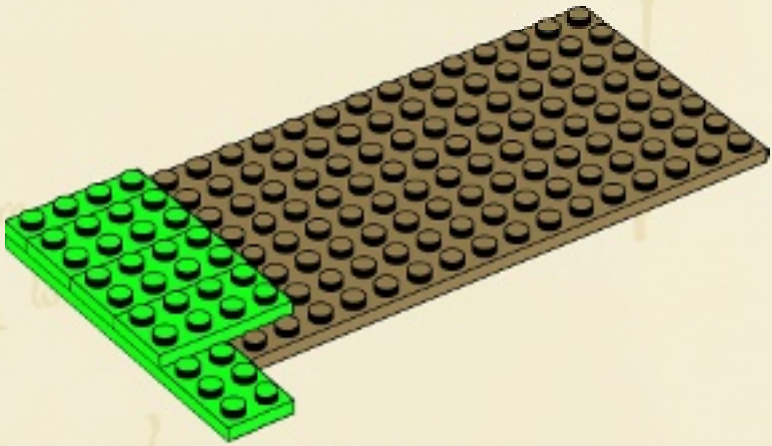

4

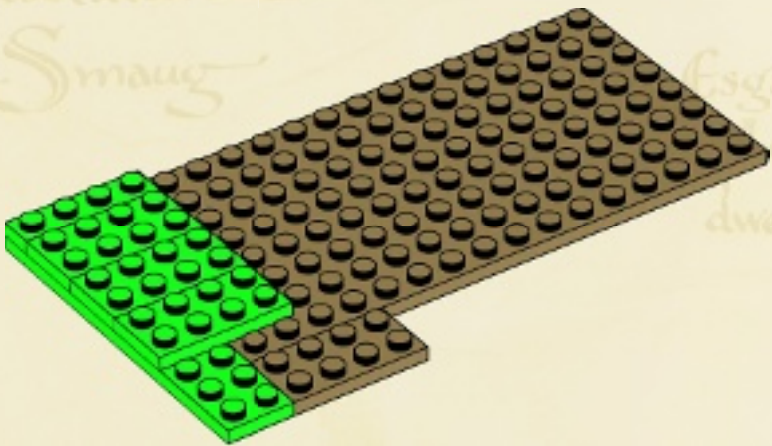



5

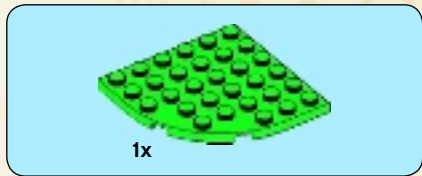
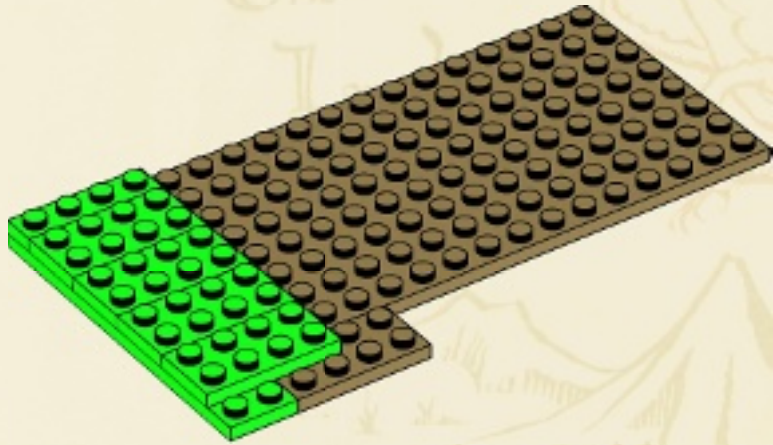

6

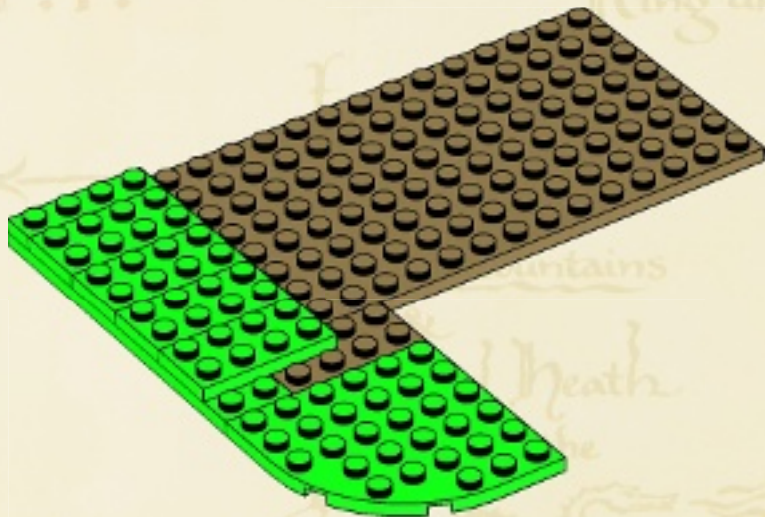



7

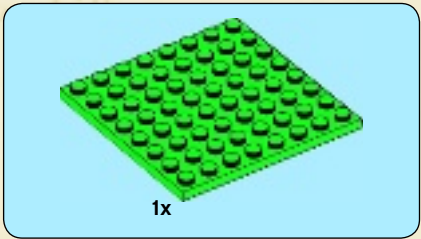
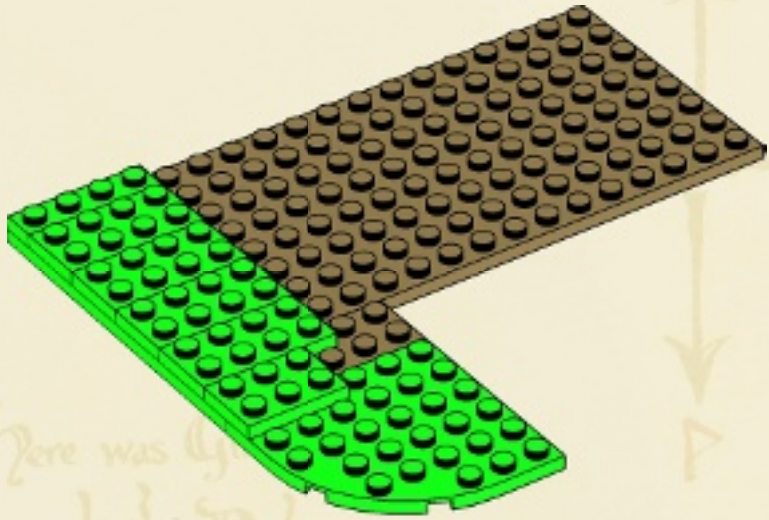

8

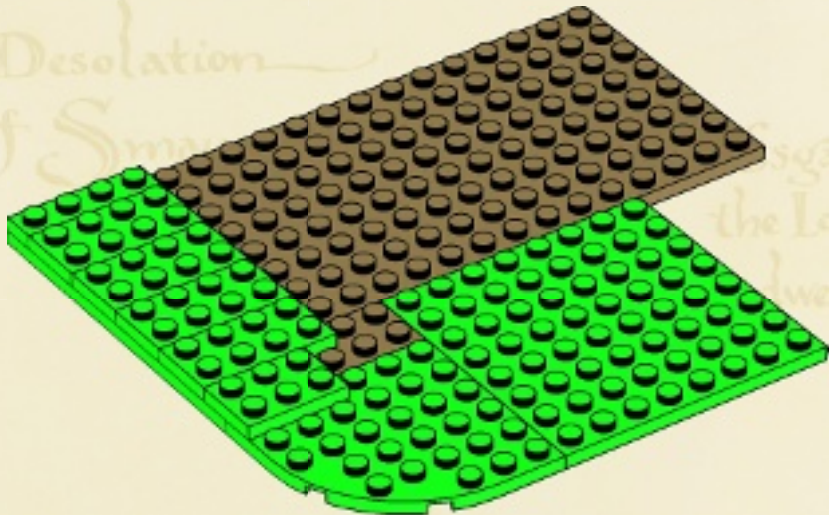



9

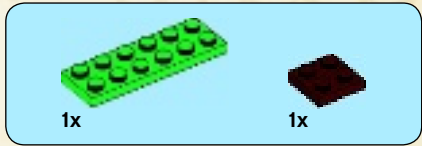
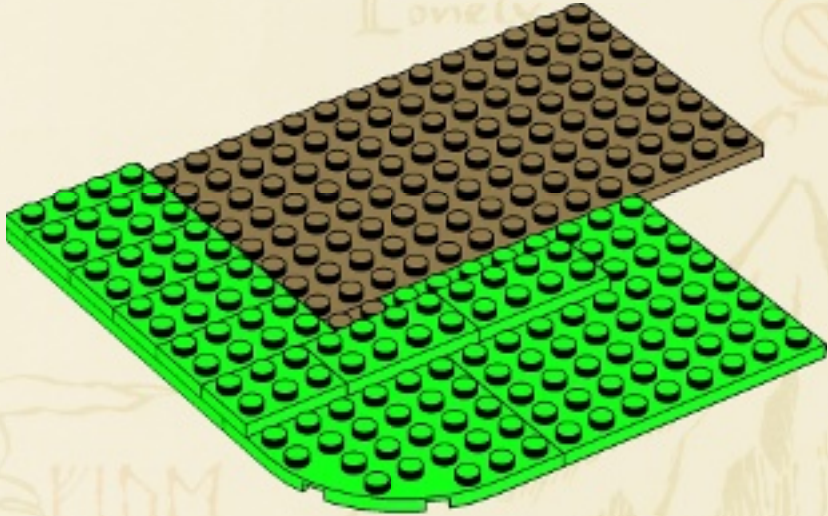

10

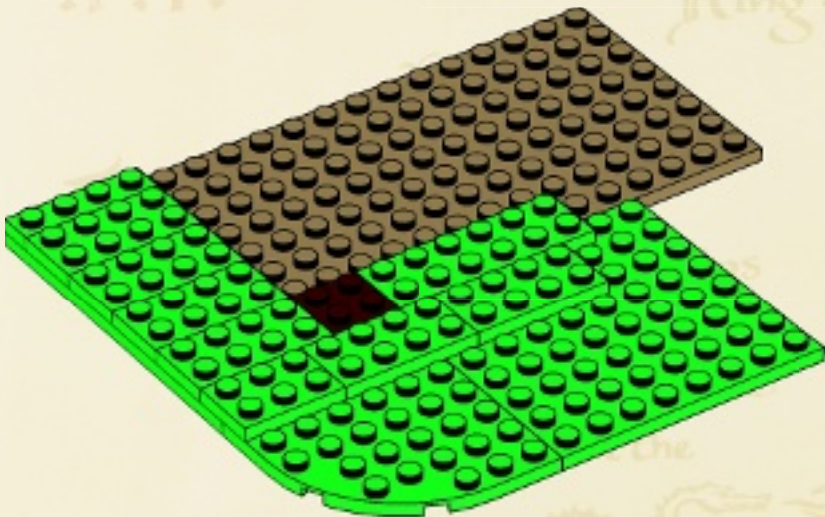

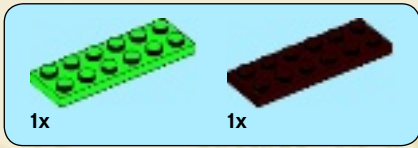

11

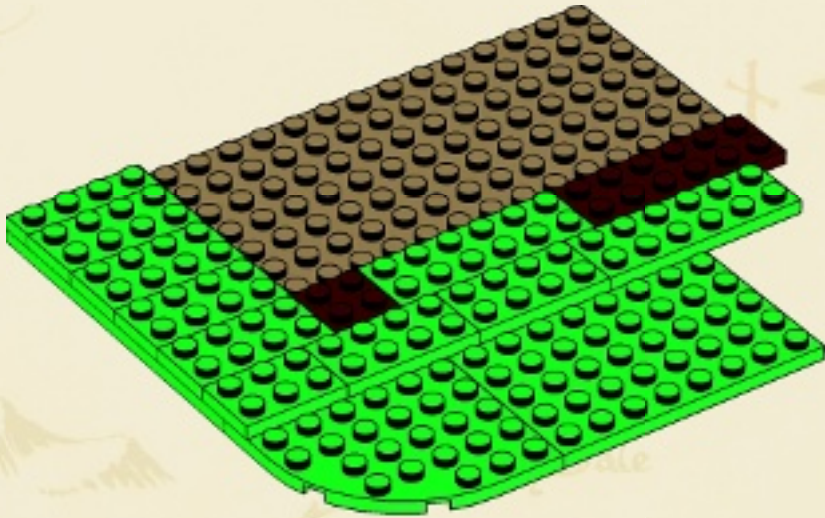

12

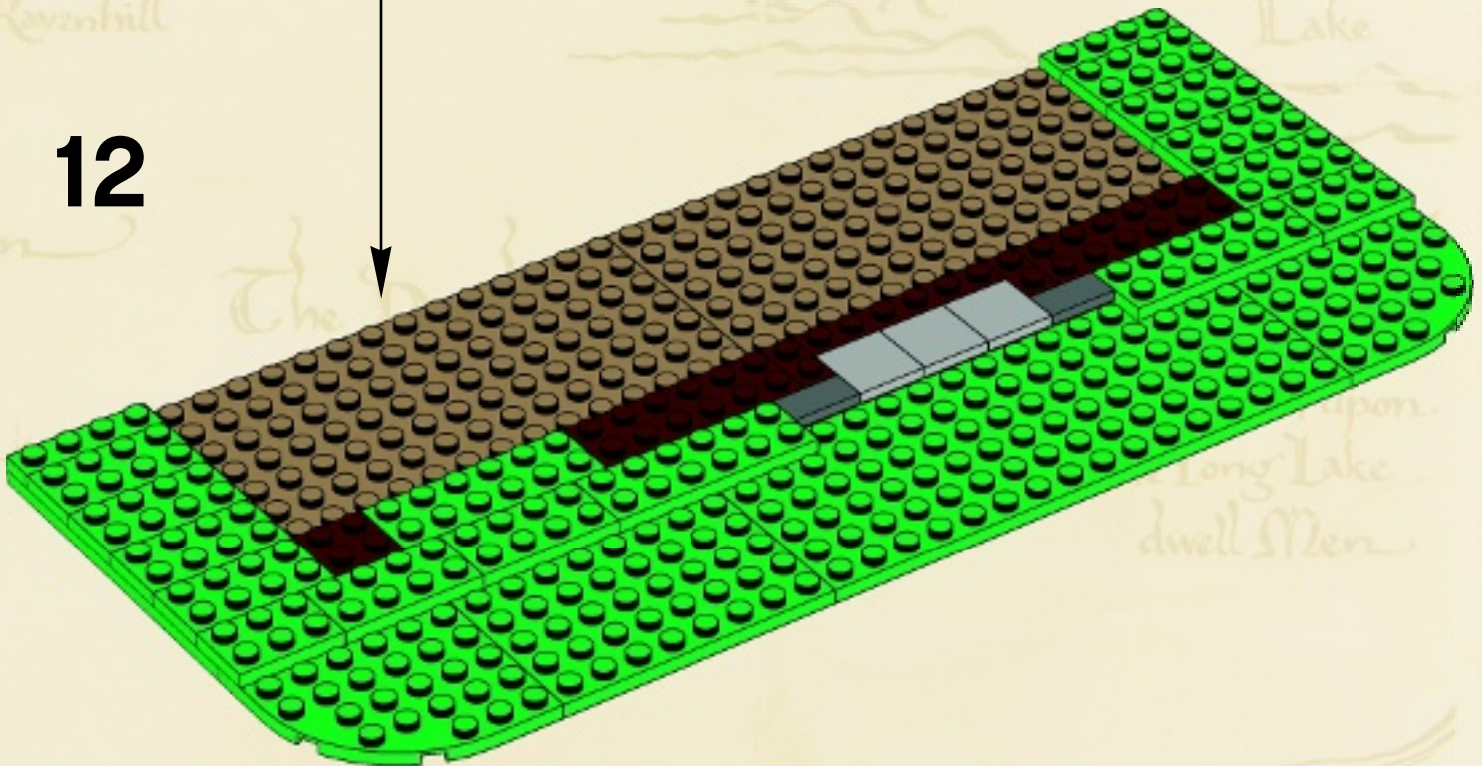

2x

13

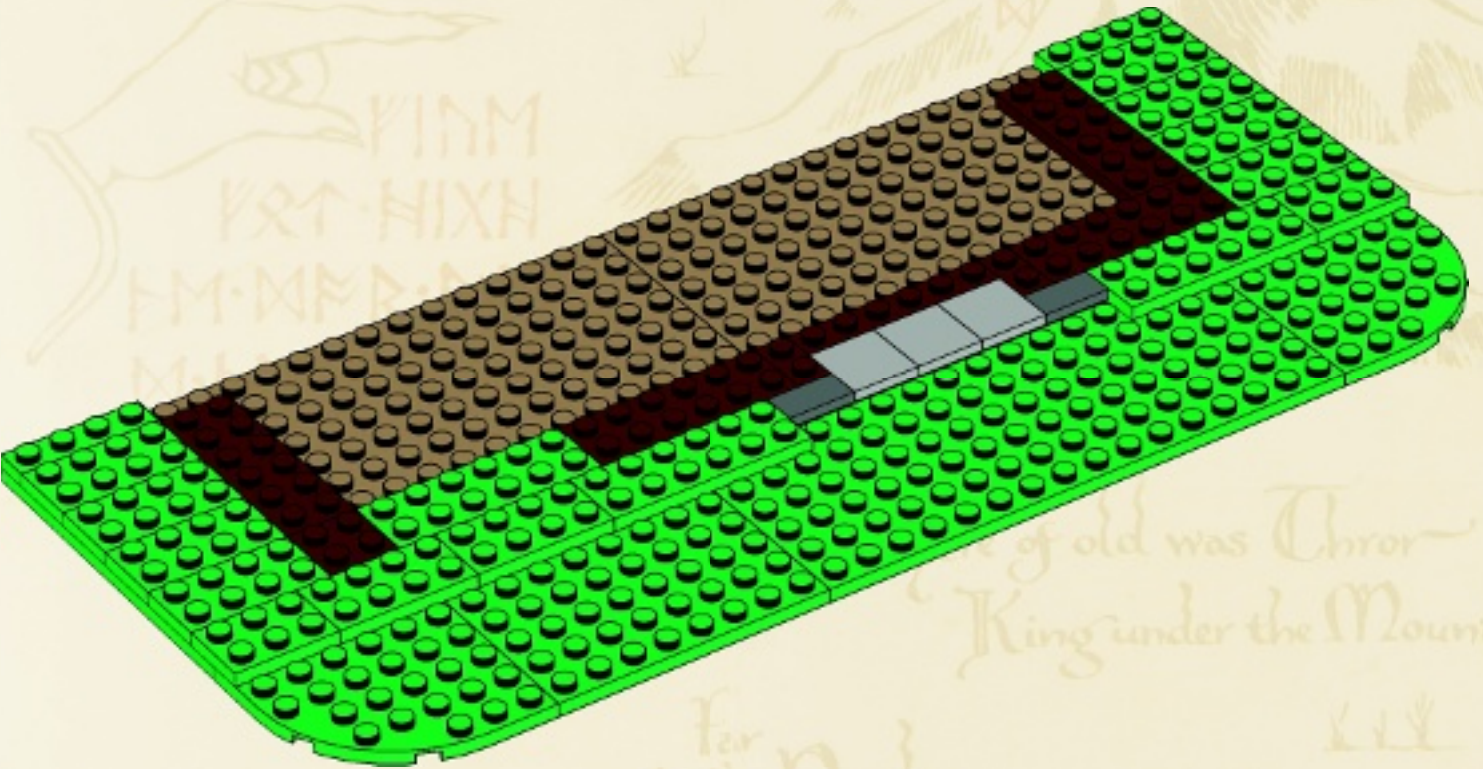

of old was Thror  
King under the Mountain

Far  
to the North  
are  
the Grey Mountains  
&  
the Withered Heath  
whence came the



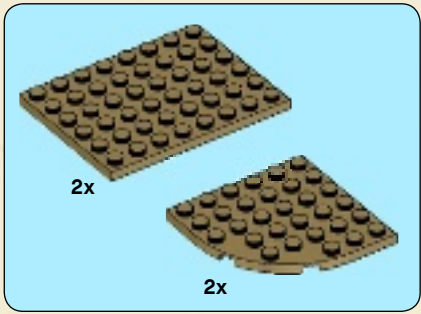

14

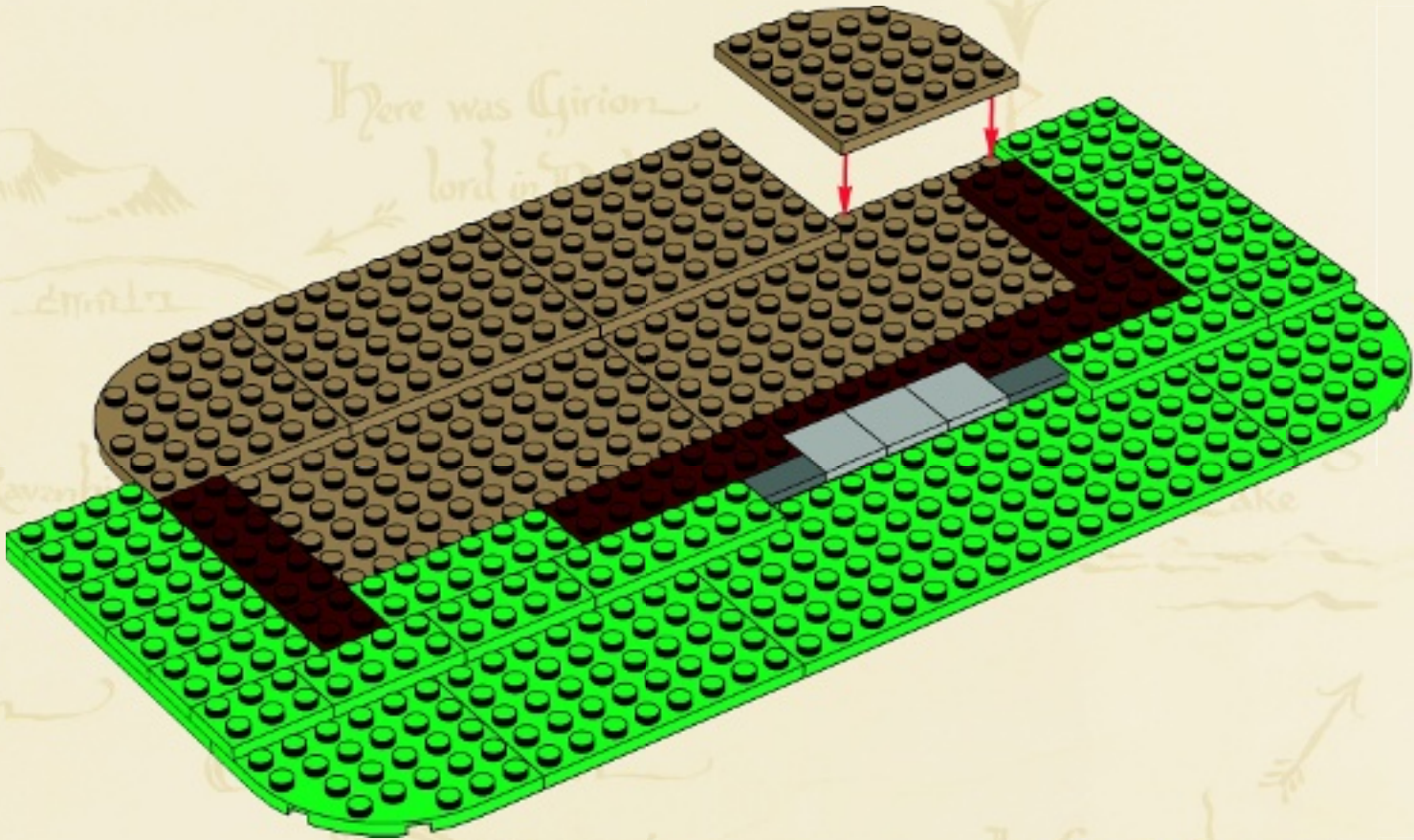



3x

15

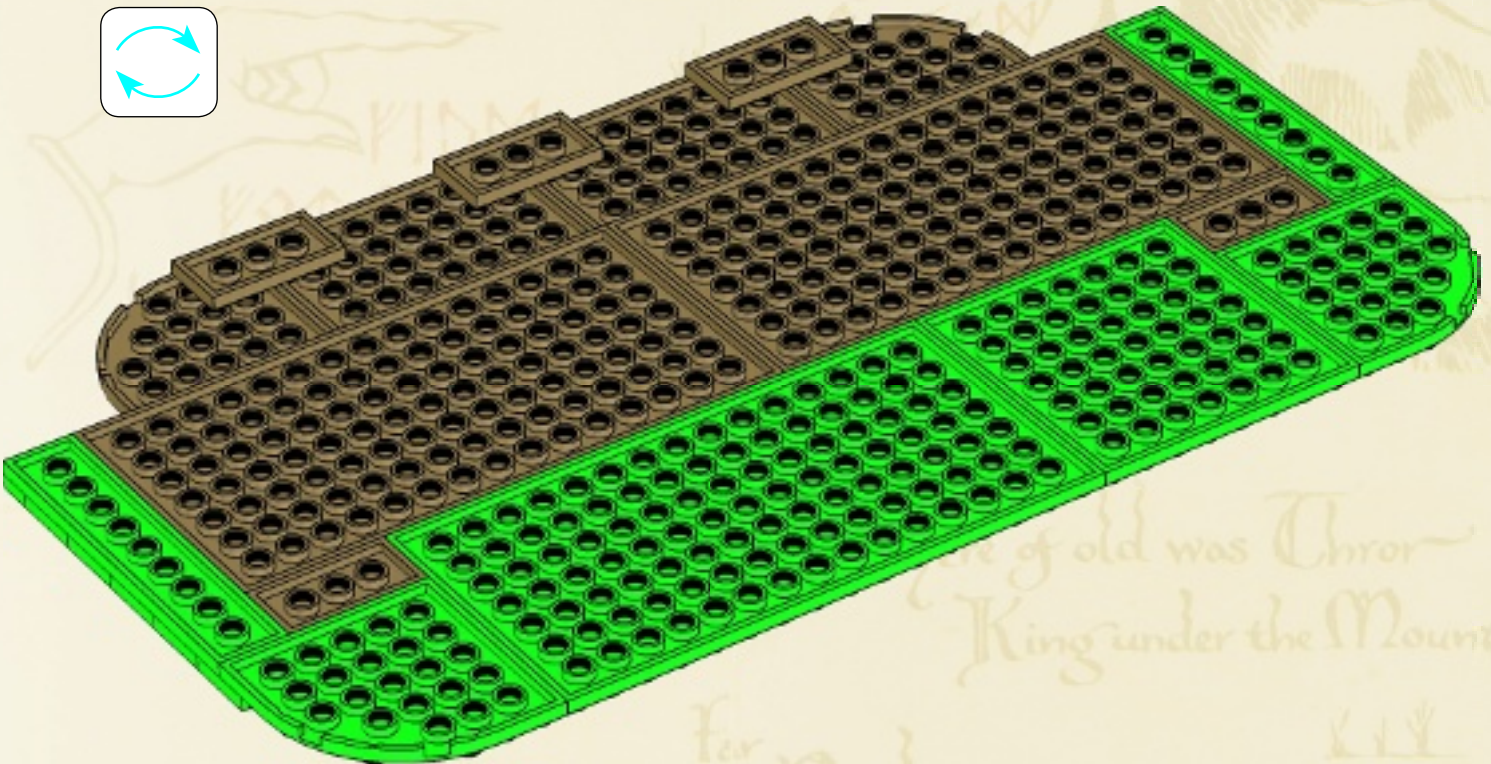

The  
Lonely  
Mountain

... of old was Thror  
King under the Mount

Far  
to the North  
are  
the Grey Mountains  
&  
the Withered Heath  
whence came the



16

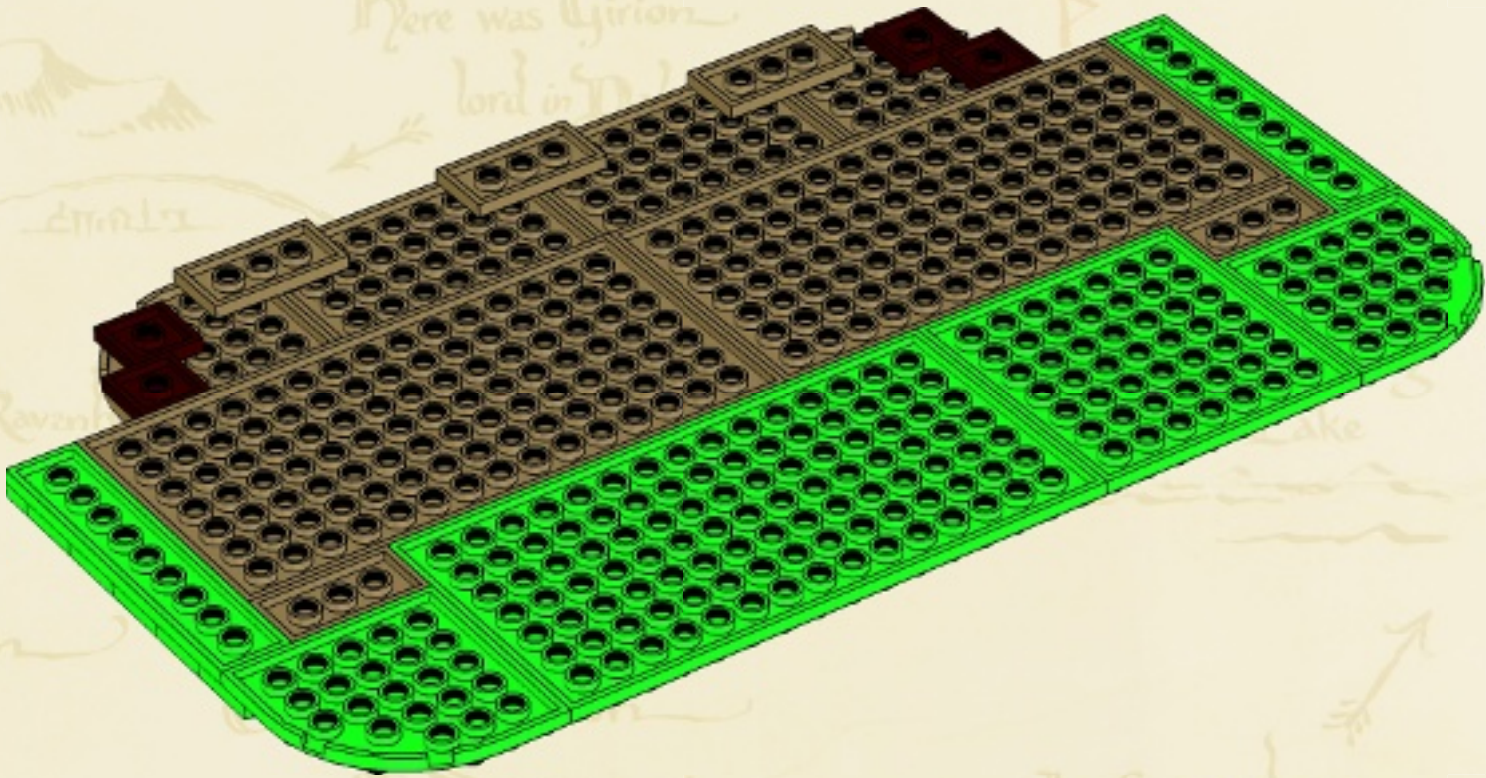

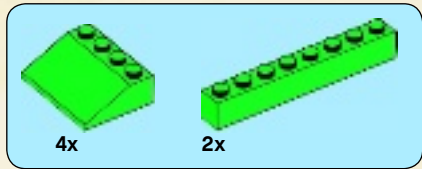

17

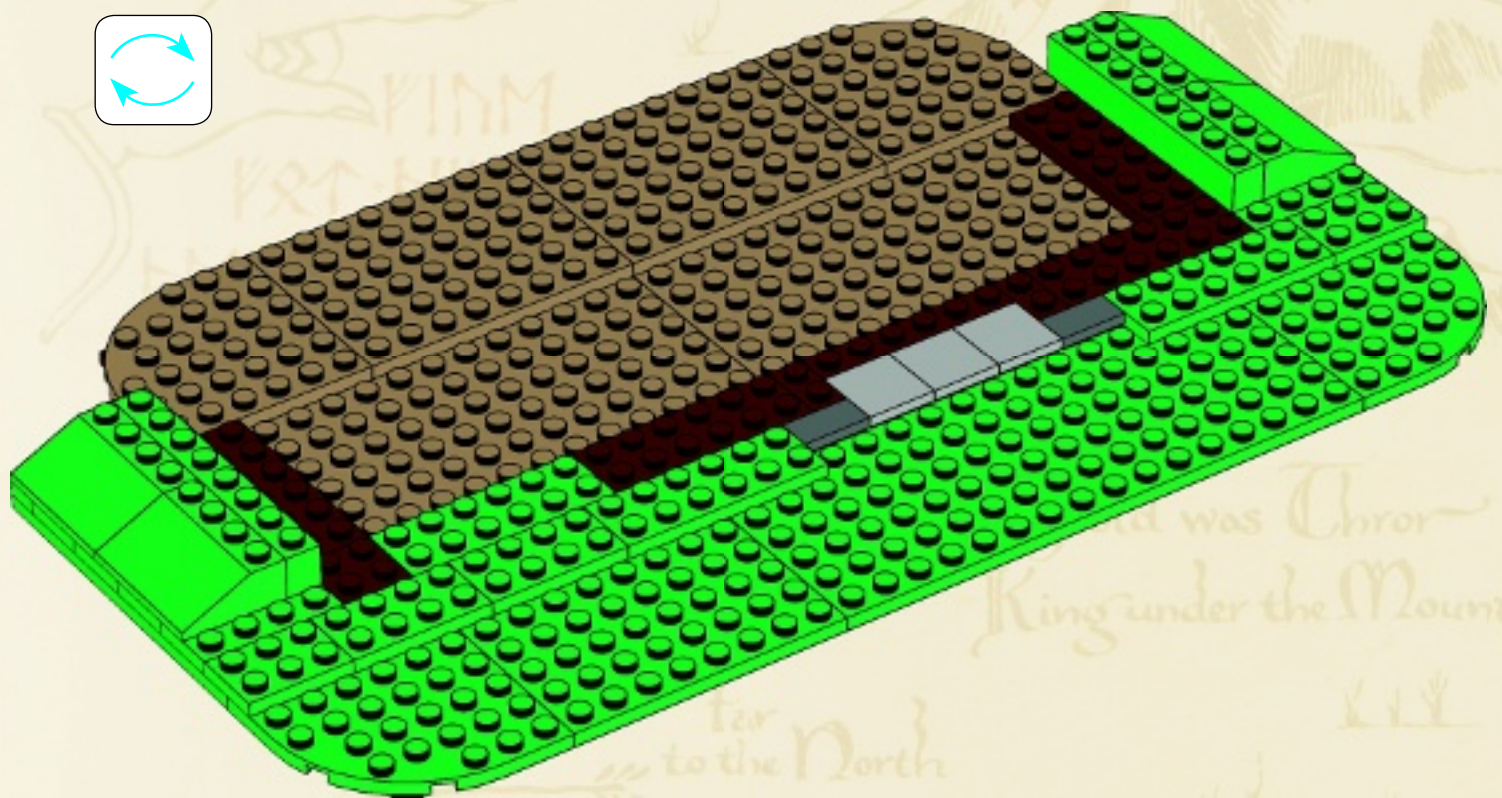
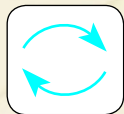



18

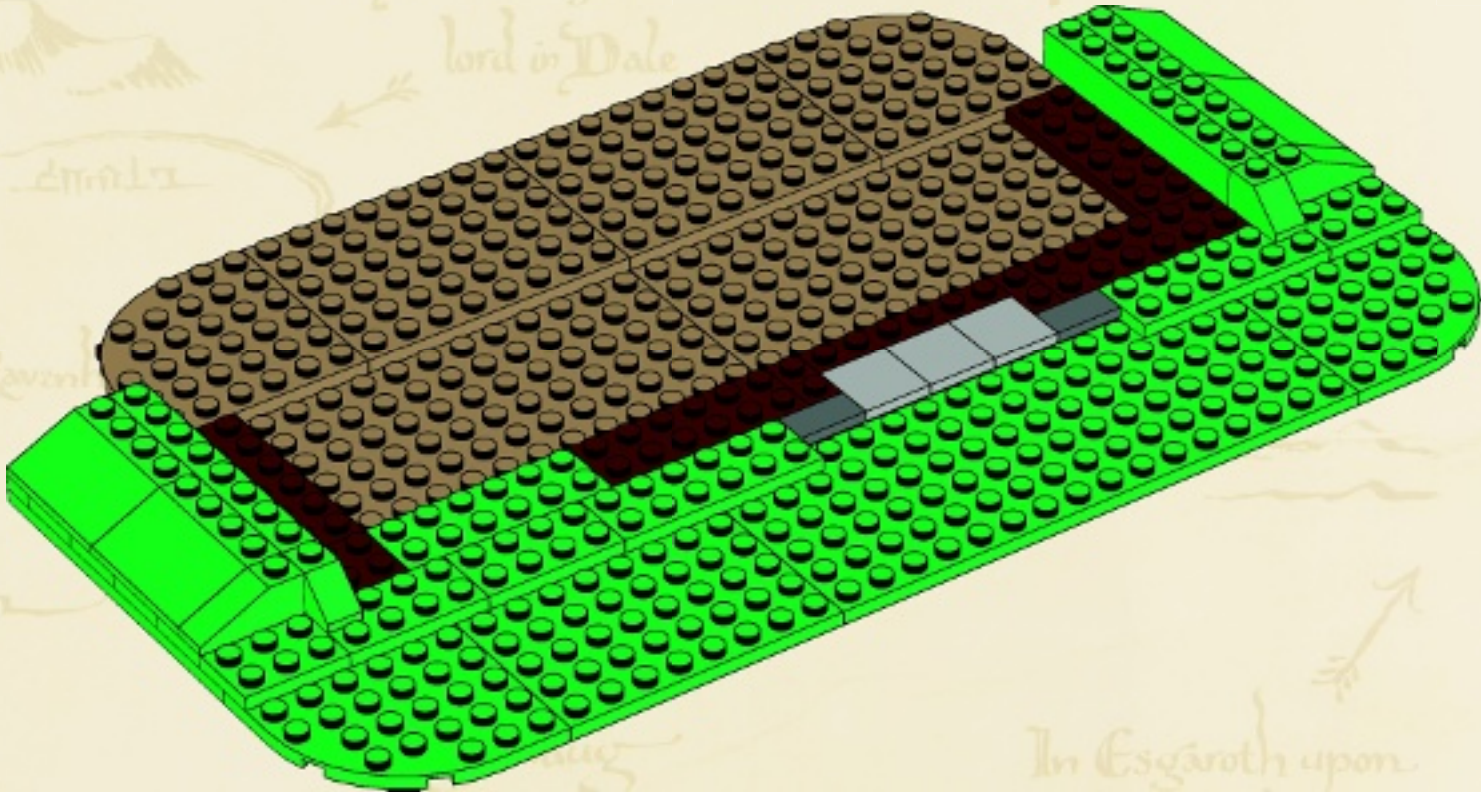

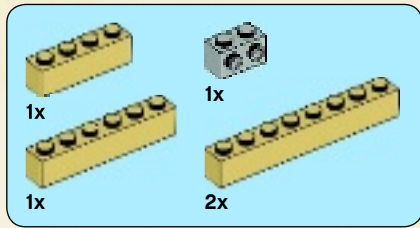

19

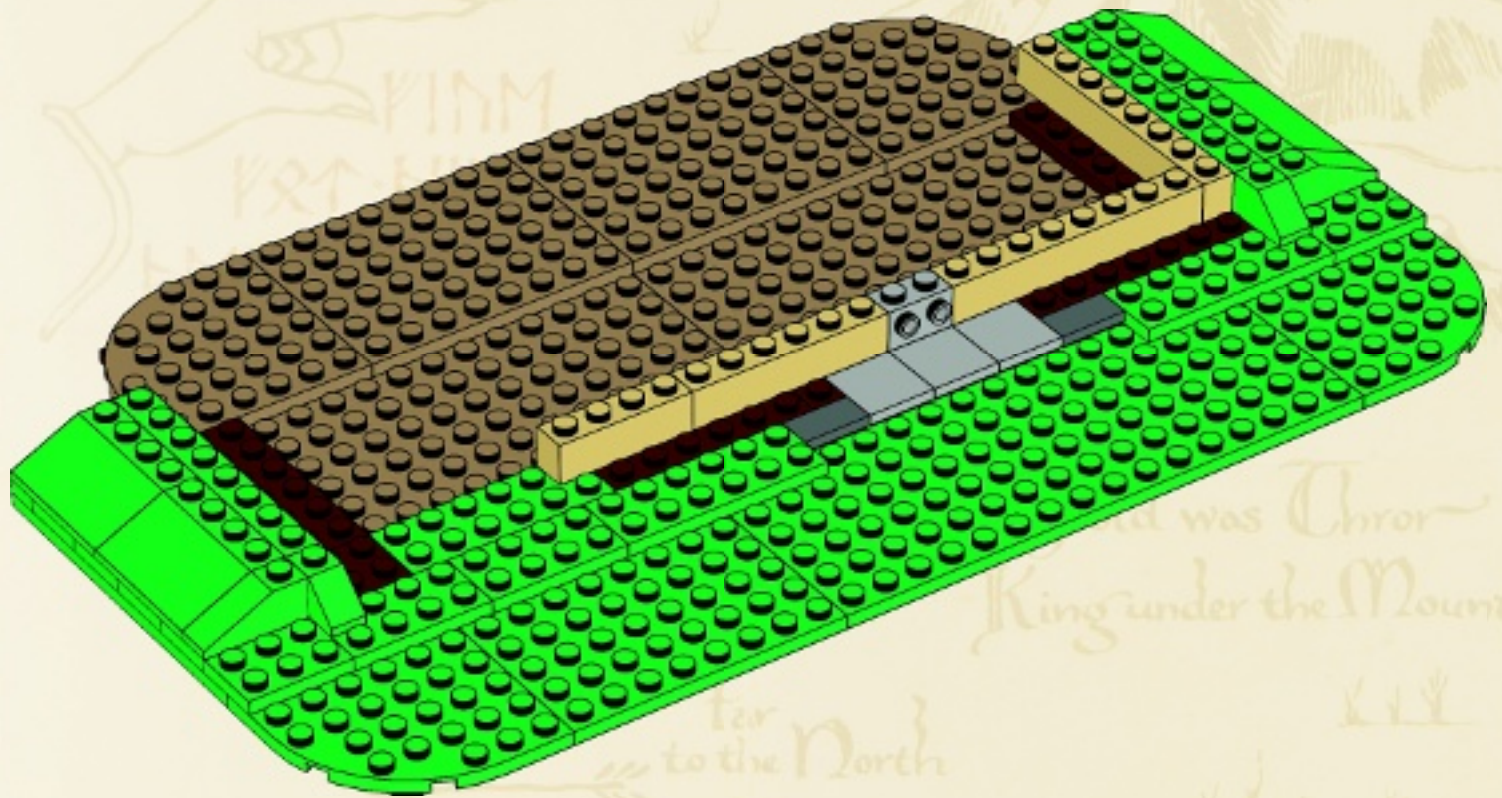

Far  
to the North  
are  
the Grey Mountains  
&  
the Withered Heath  
whence came the

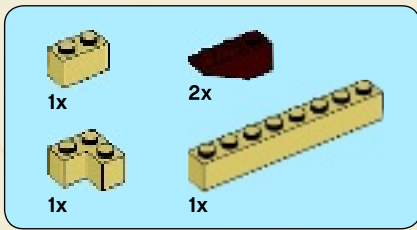

20

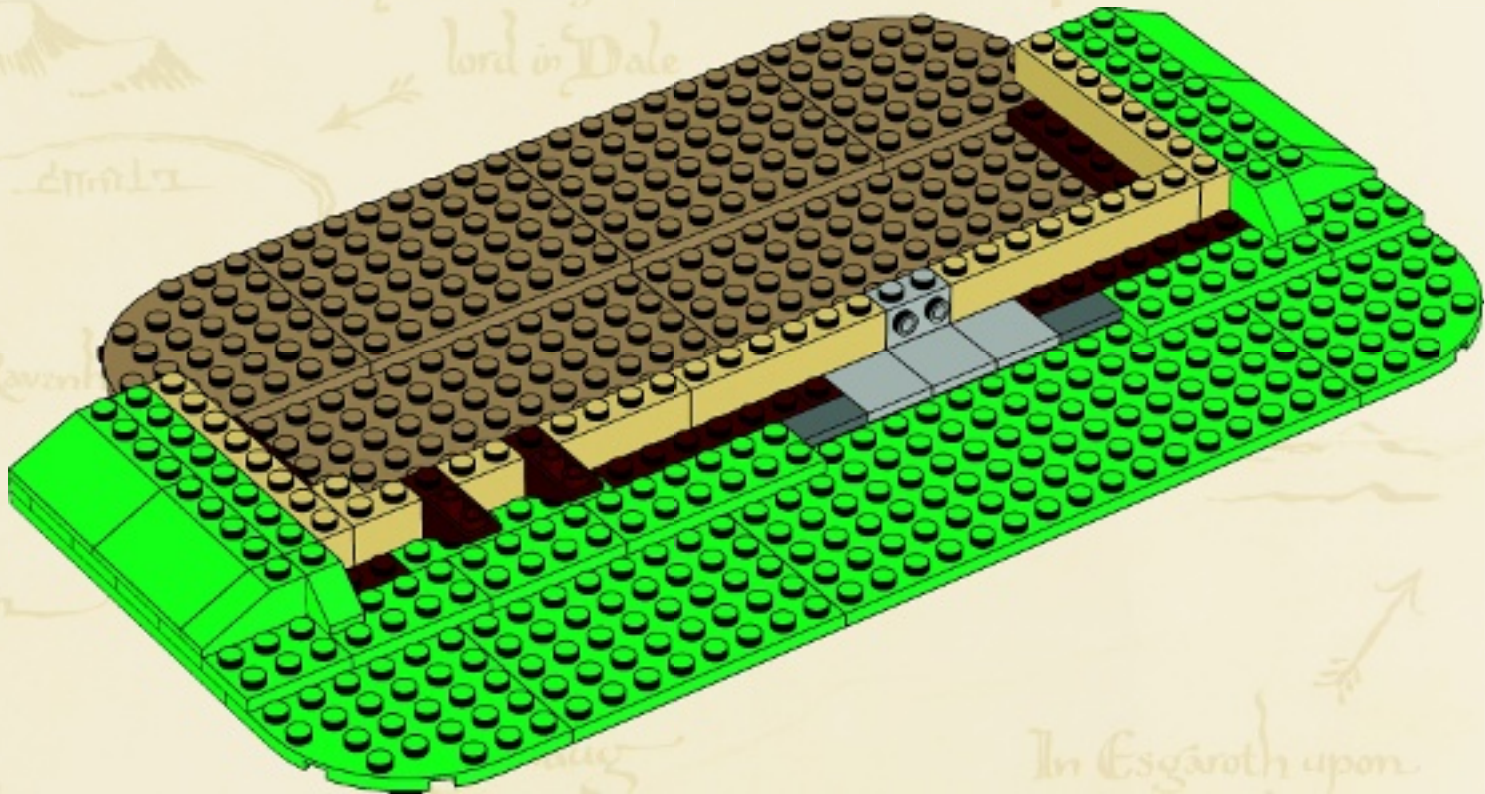

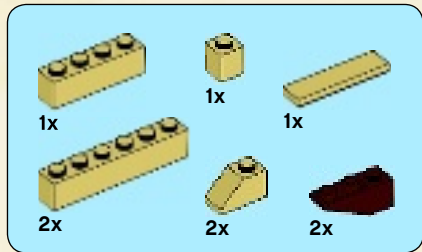

21

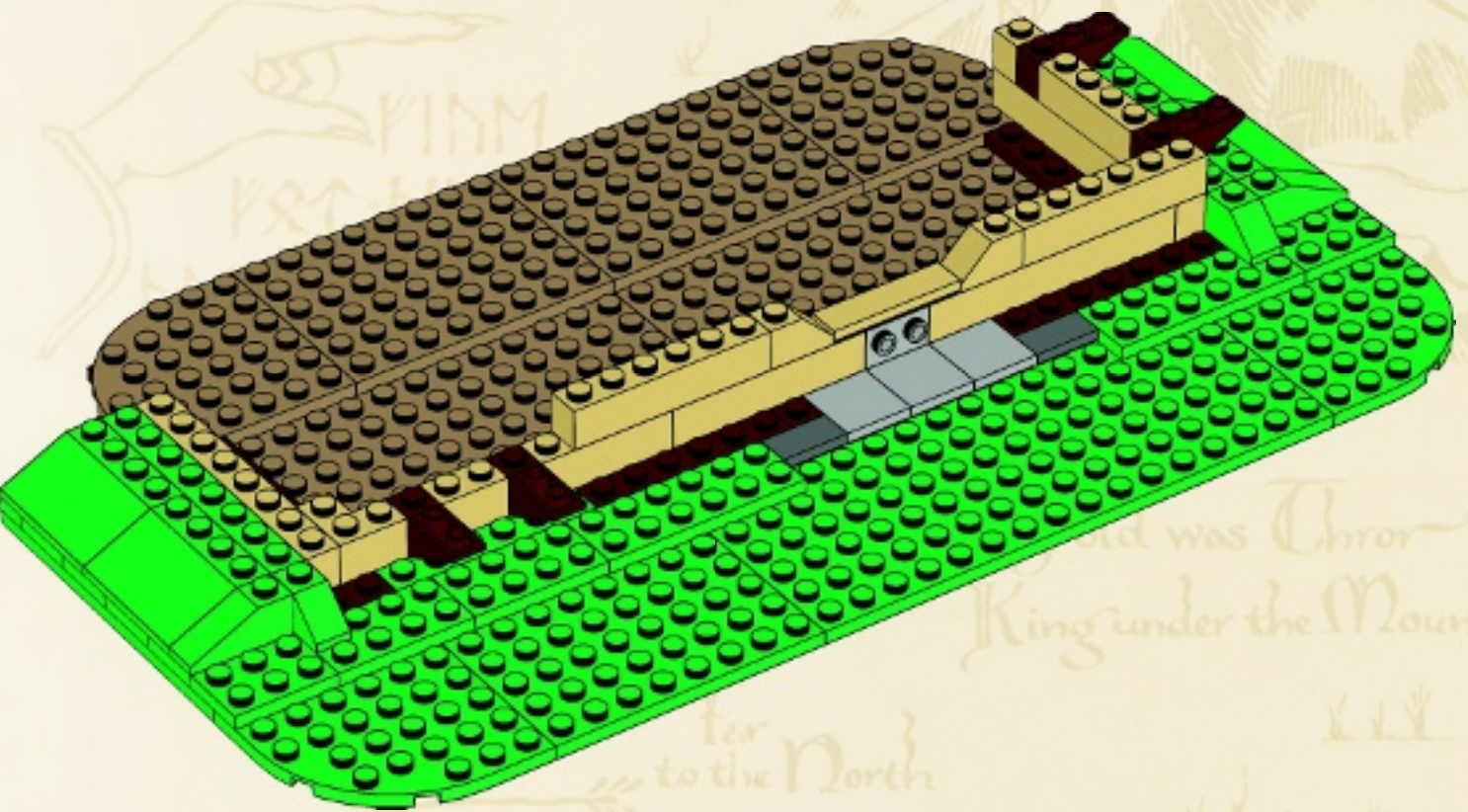

The  
Lonely  
Mountain

... was Thoror  
King under the Mount

far  
to the North  
are  
the Grey Mountains  
&  
the Withered Heath  
whence came the



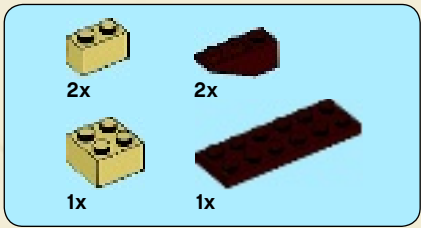

22

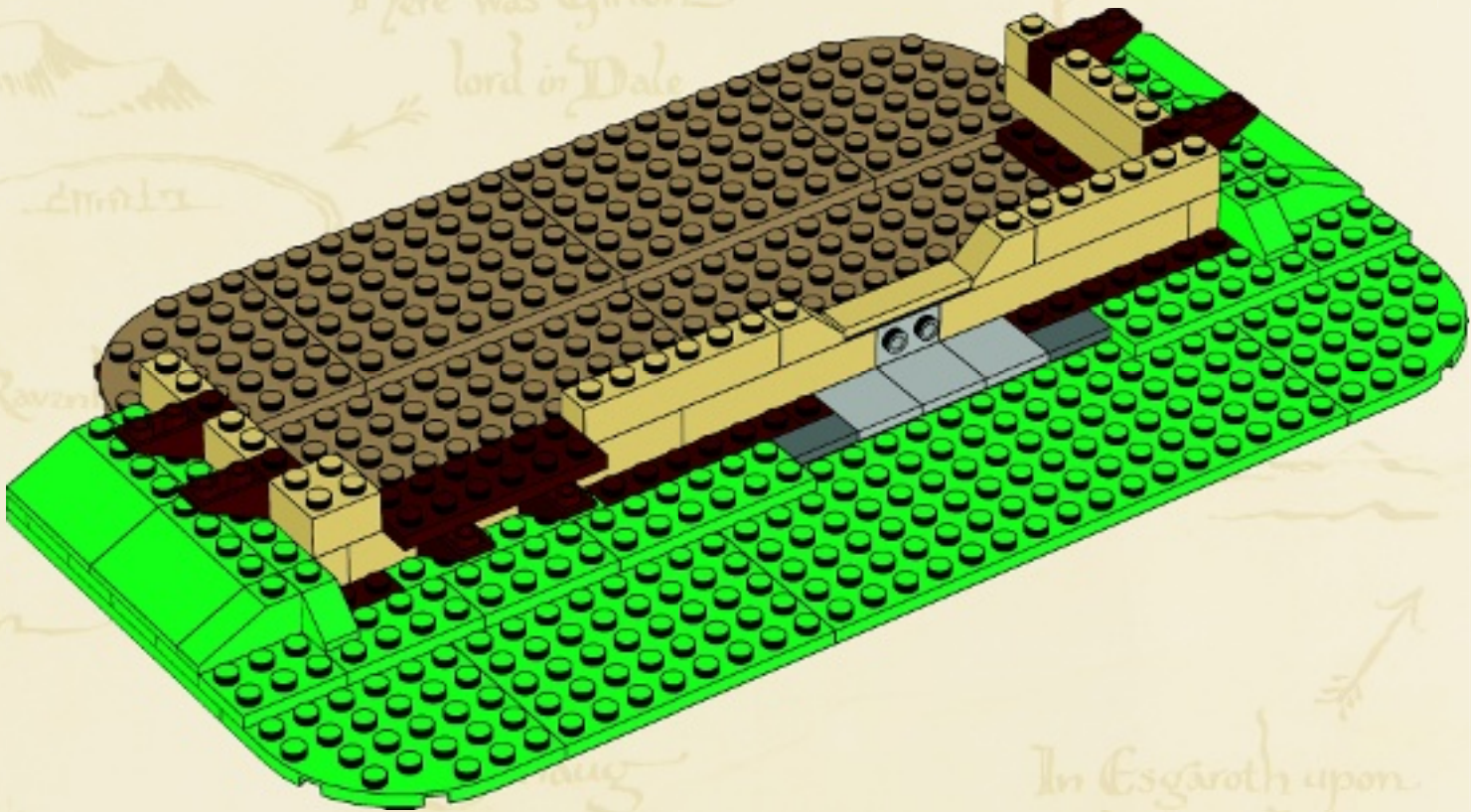

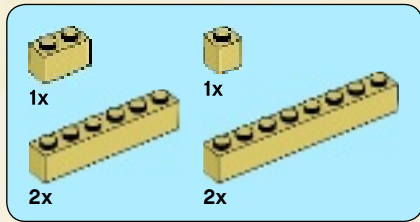

23

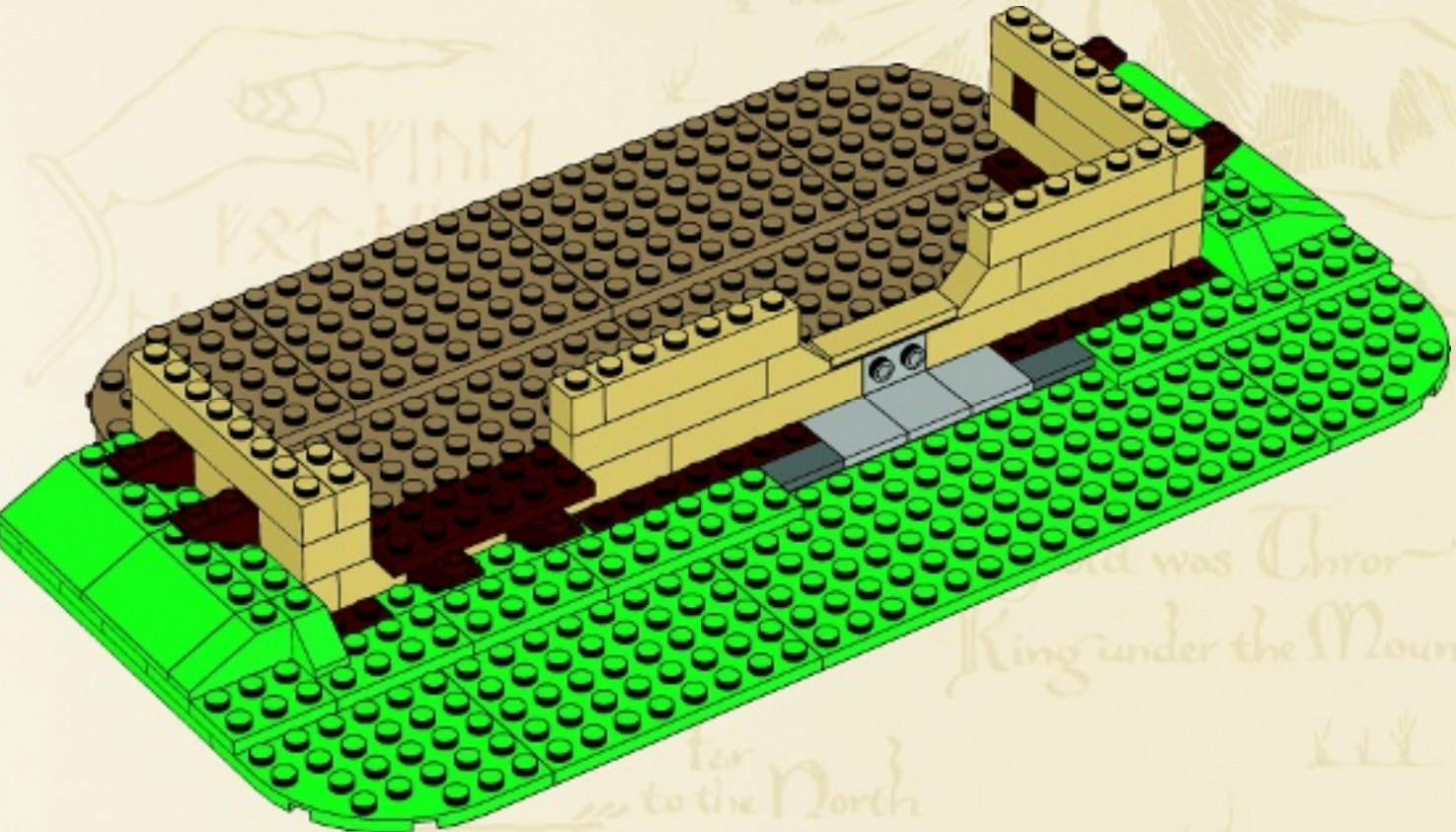

The  
Lonely  
Mountain

... was Thor  
King under the Mount

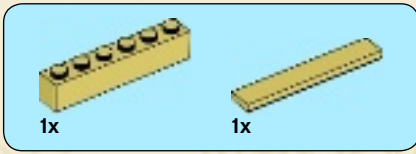

Far  
to the North  
are  
the Grey Mountains  
&  
the Withered Heath  
whence came the

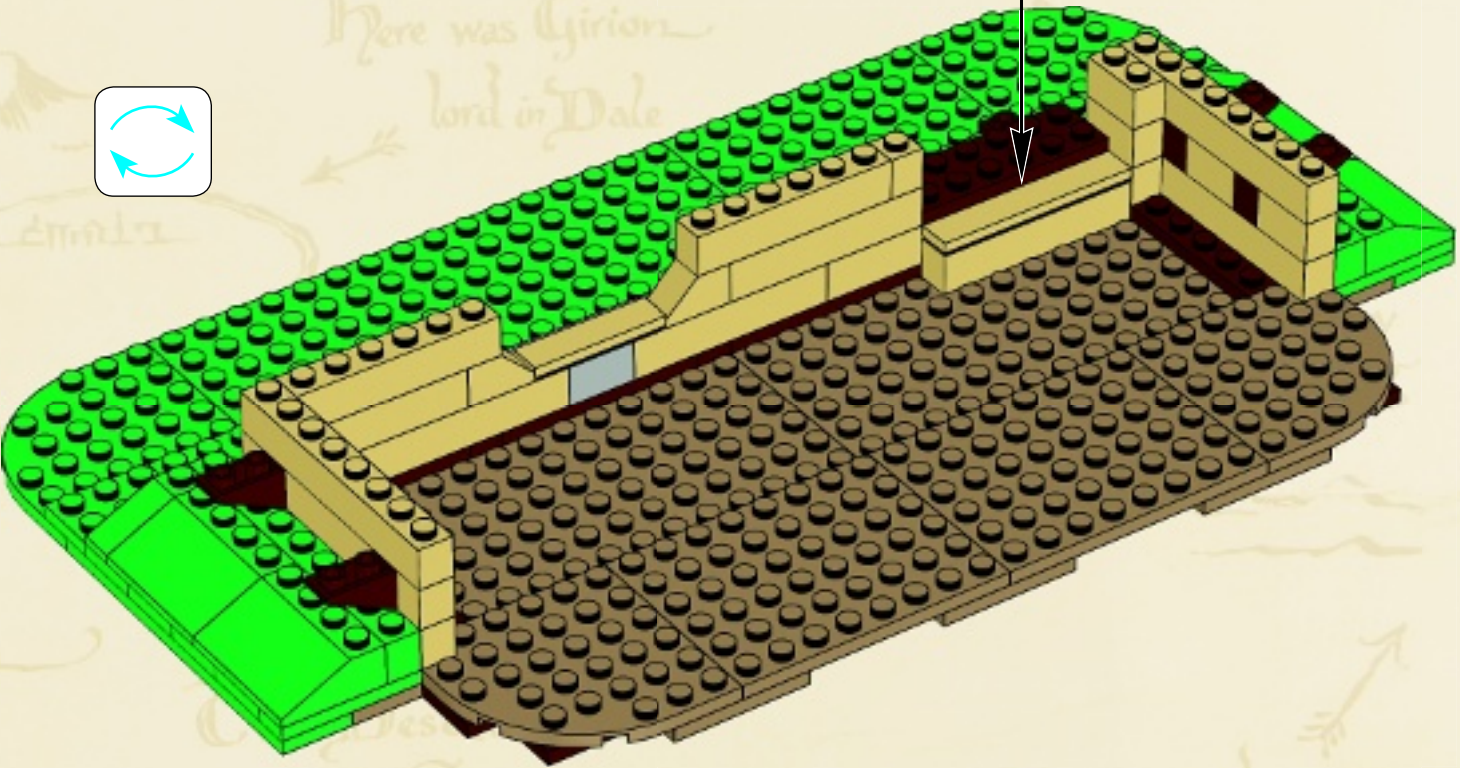
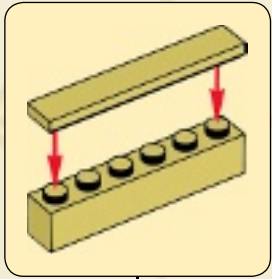

24



In Esgaroth upon  
the Long Lake  
dwell Men

	
2x	1x

# 25

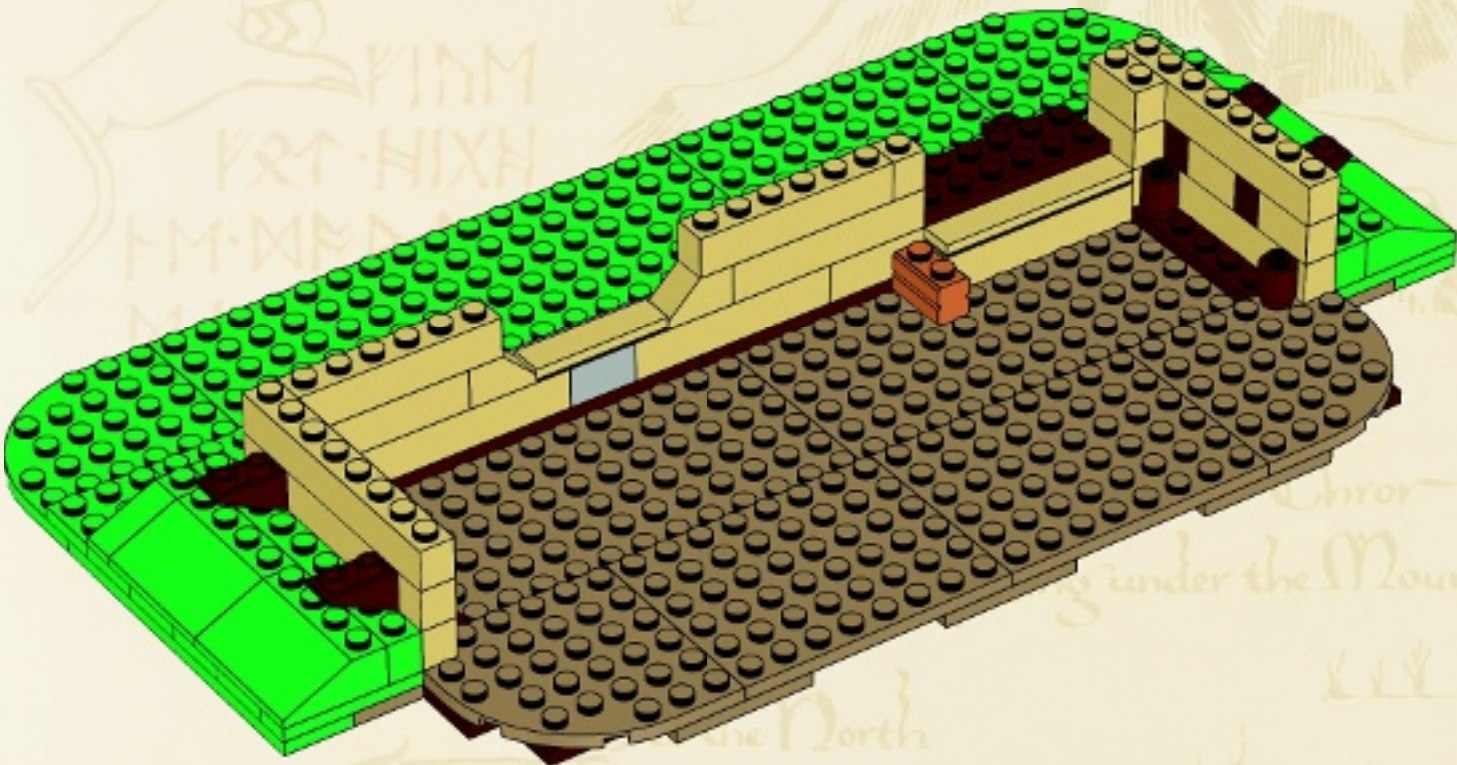

The  
Lonely  
Mountain

Under the Mountain

the North  
are  
the Grey Mountains  
&  
the Withered Heath  
whence came the



26

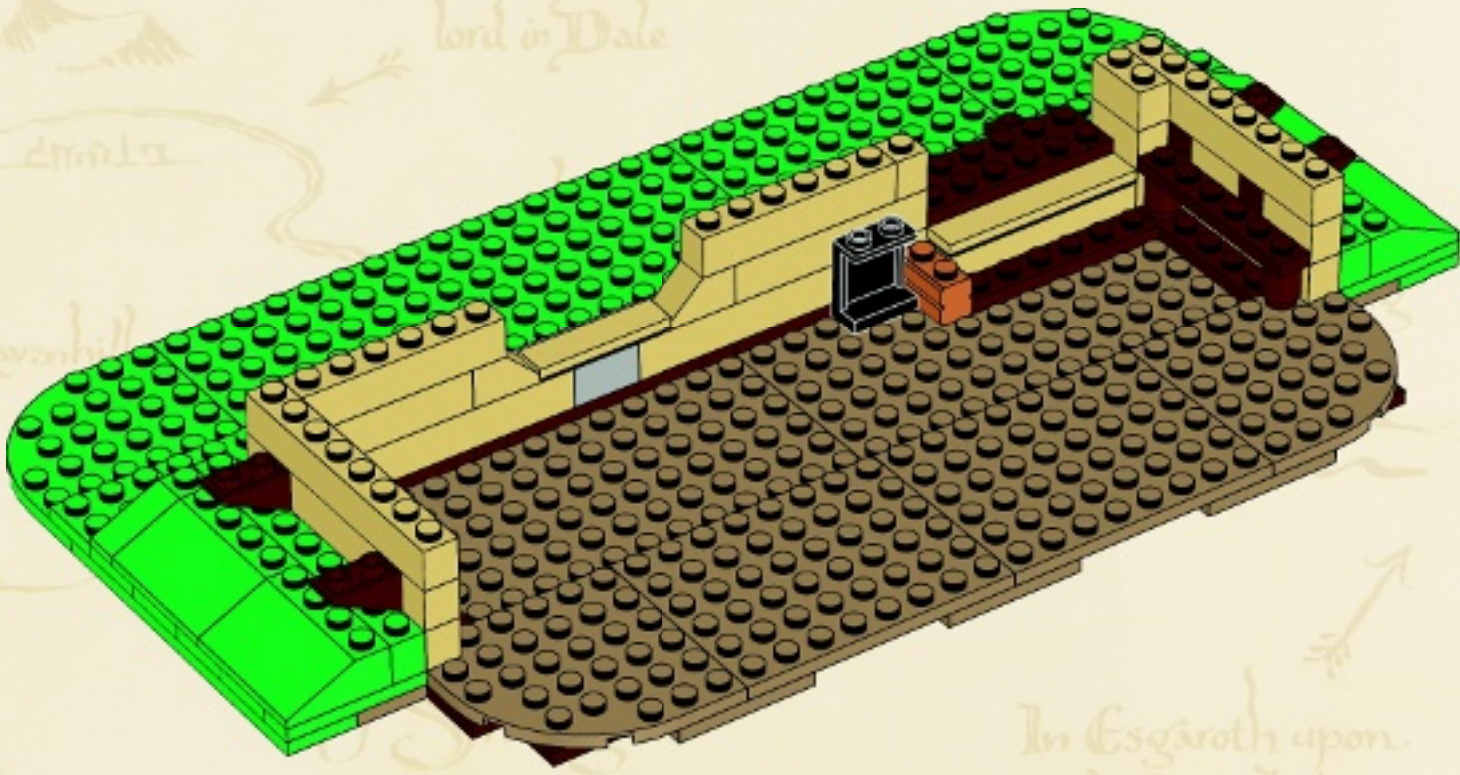

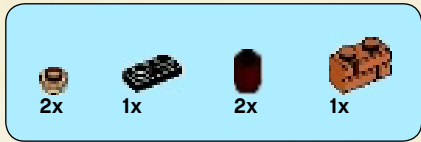

# 27

- 1
- 2

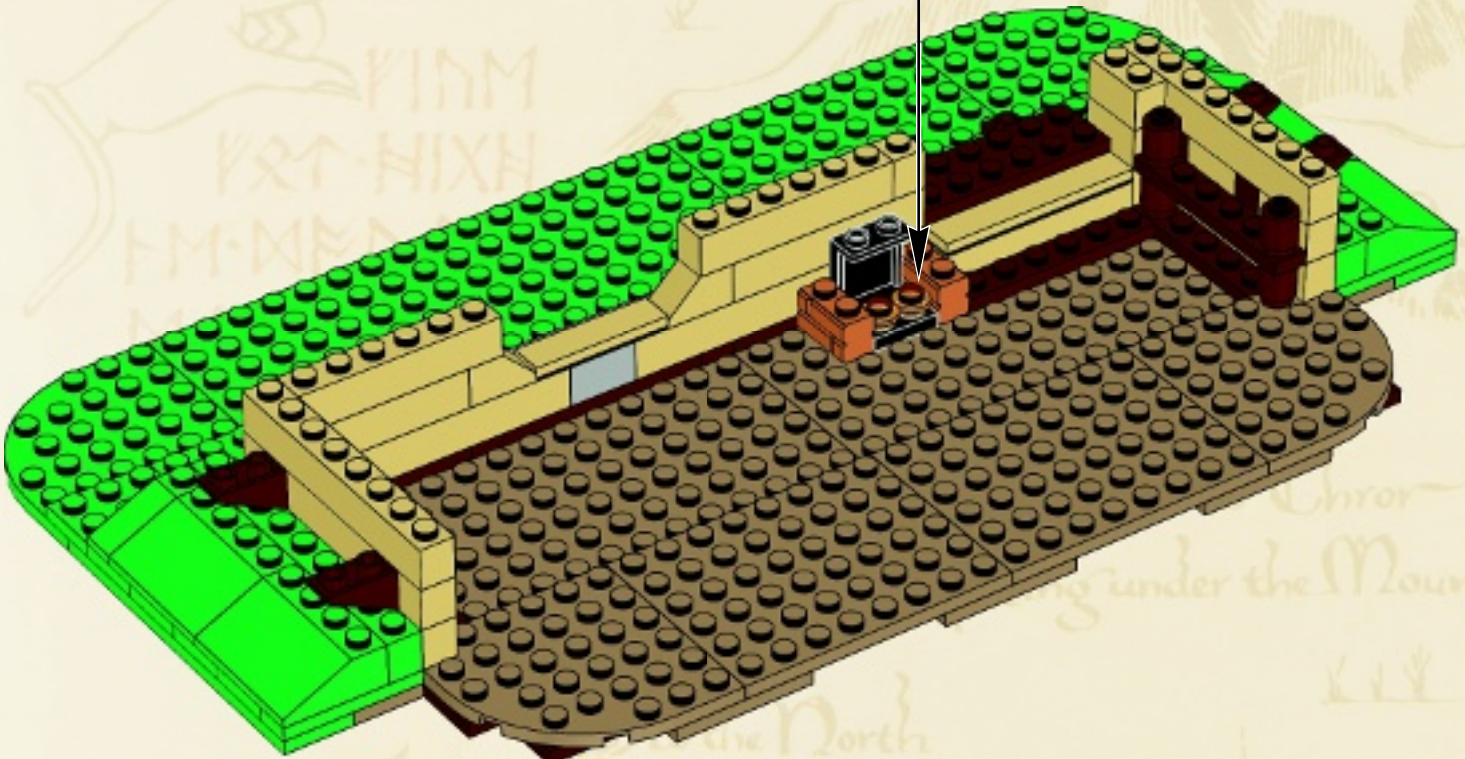



28

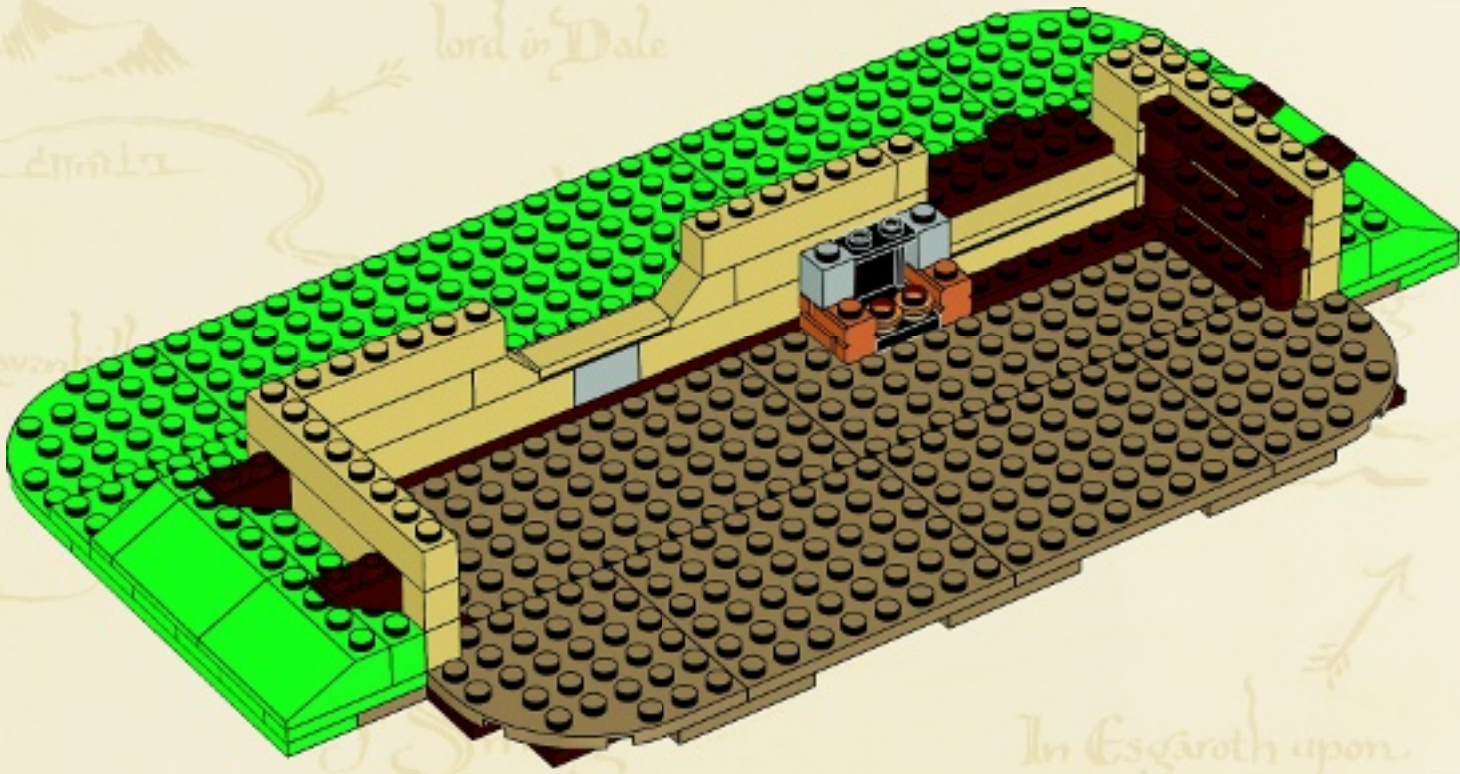

on Hills  
where is Dair



Here was Giron  
lord in Dale

In Esgaroth upon  
the Long Lake  
dwell Men



# 29

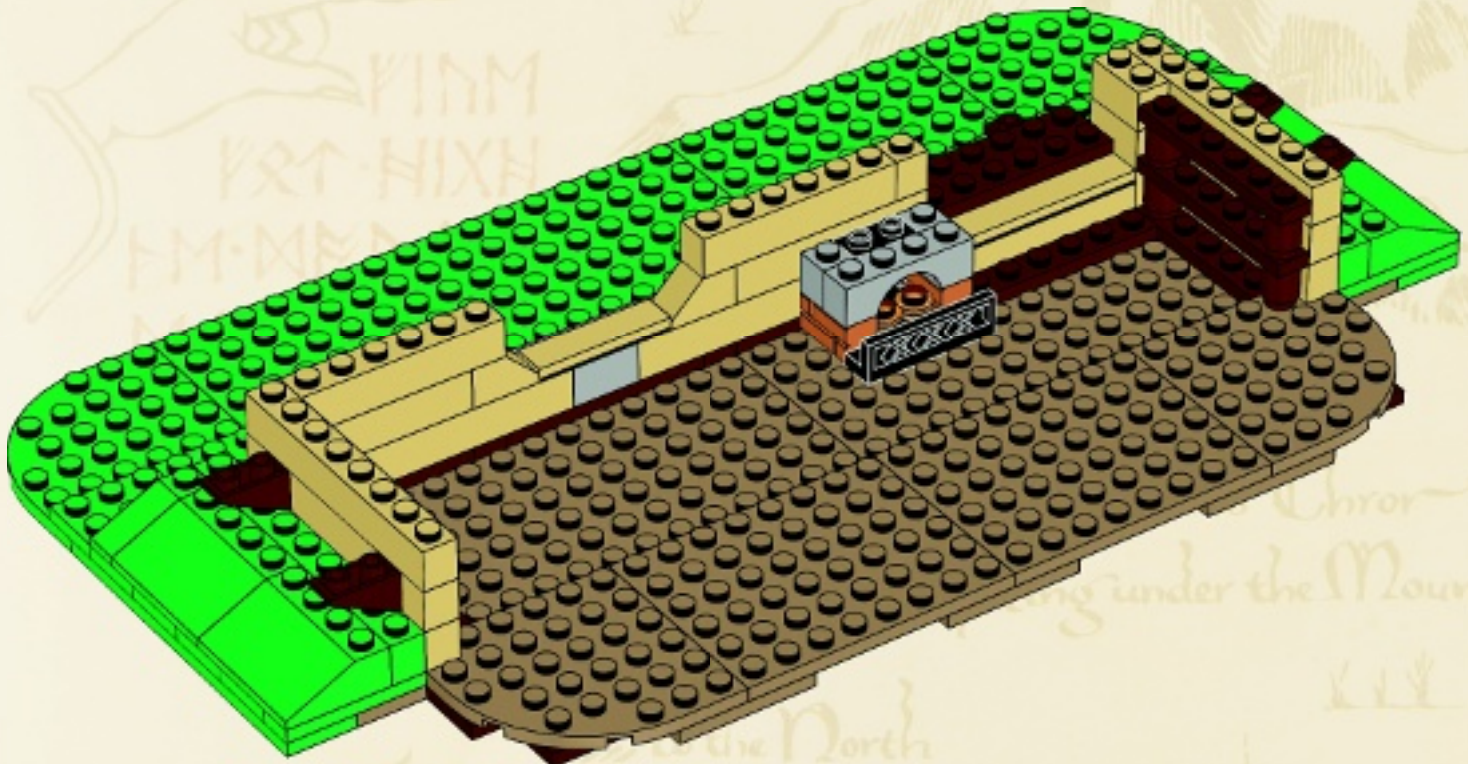

The  
Lonely  
Mountain

VINM  
KST·HIXH  
FM·MMA

Chror  
ing under the Mount

the North  
are  
the Grey Mountains  
&  
the Withered Heath  
whence came the



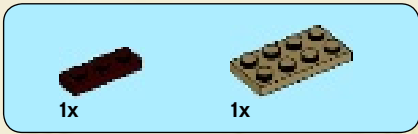

30

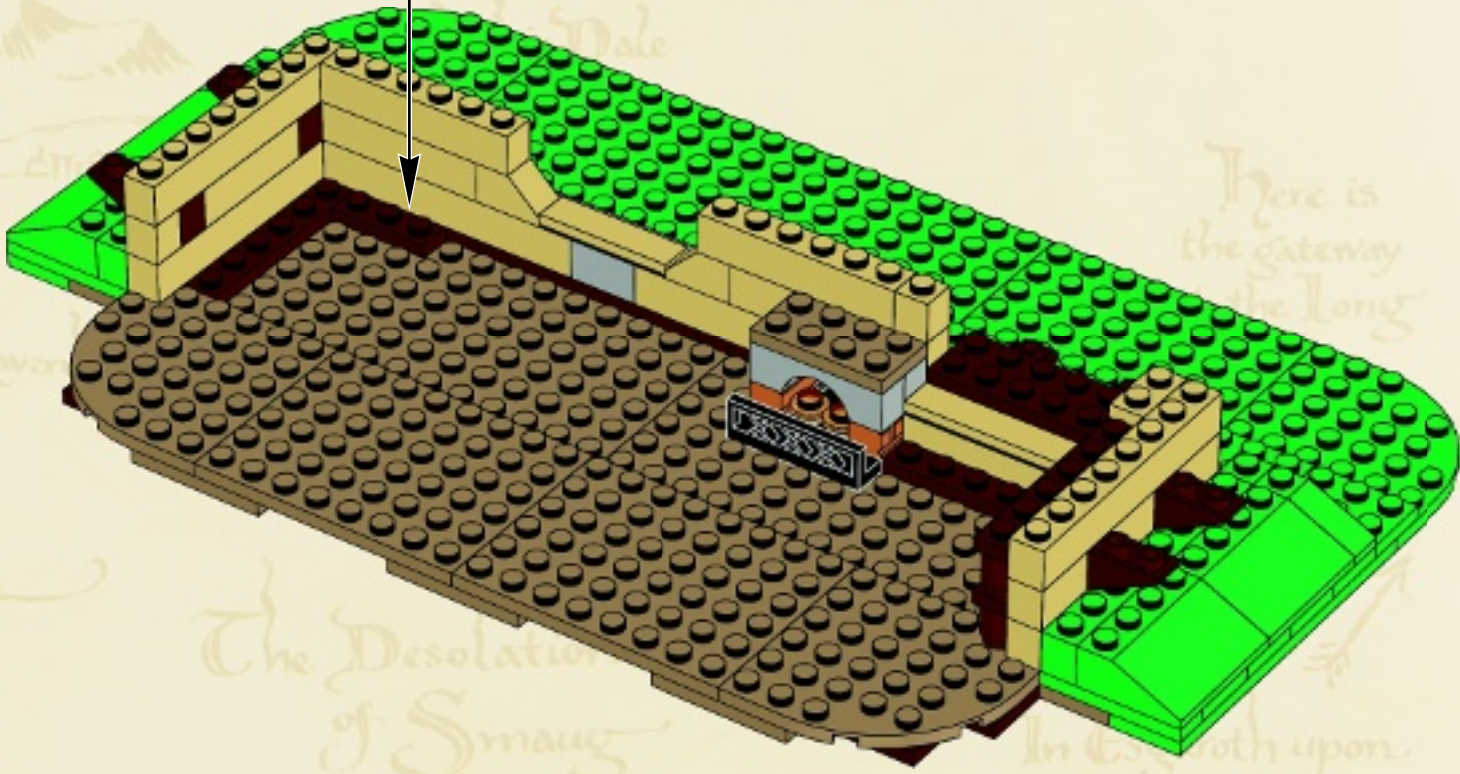
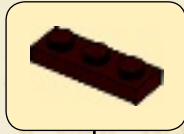
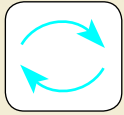



2x



1x

# 31

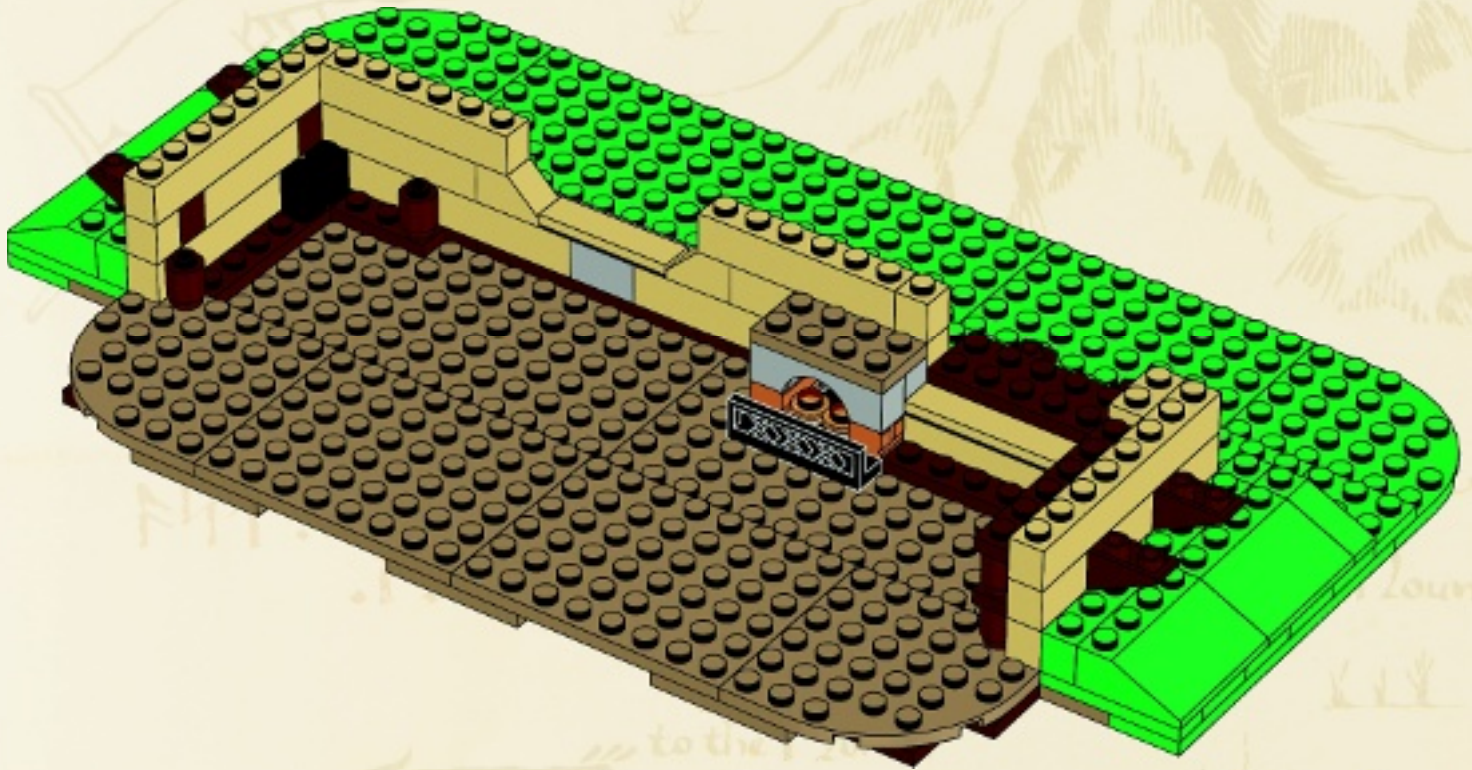

to the  
are  
the Grey Mountains  
&  
the Withered Heath  
whence came the

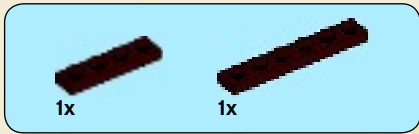

32

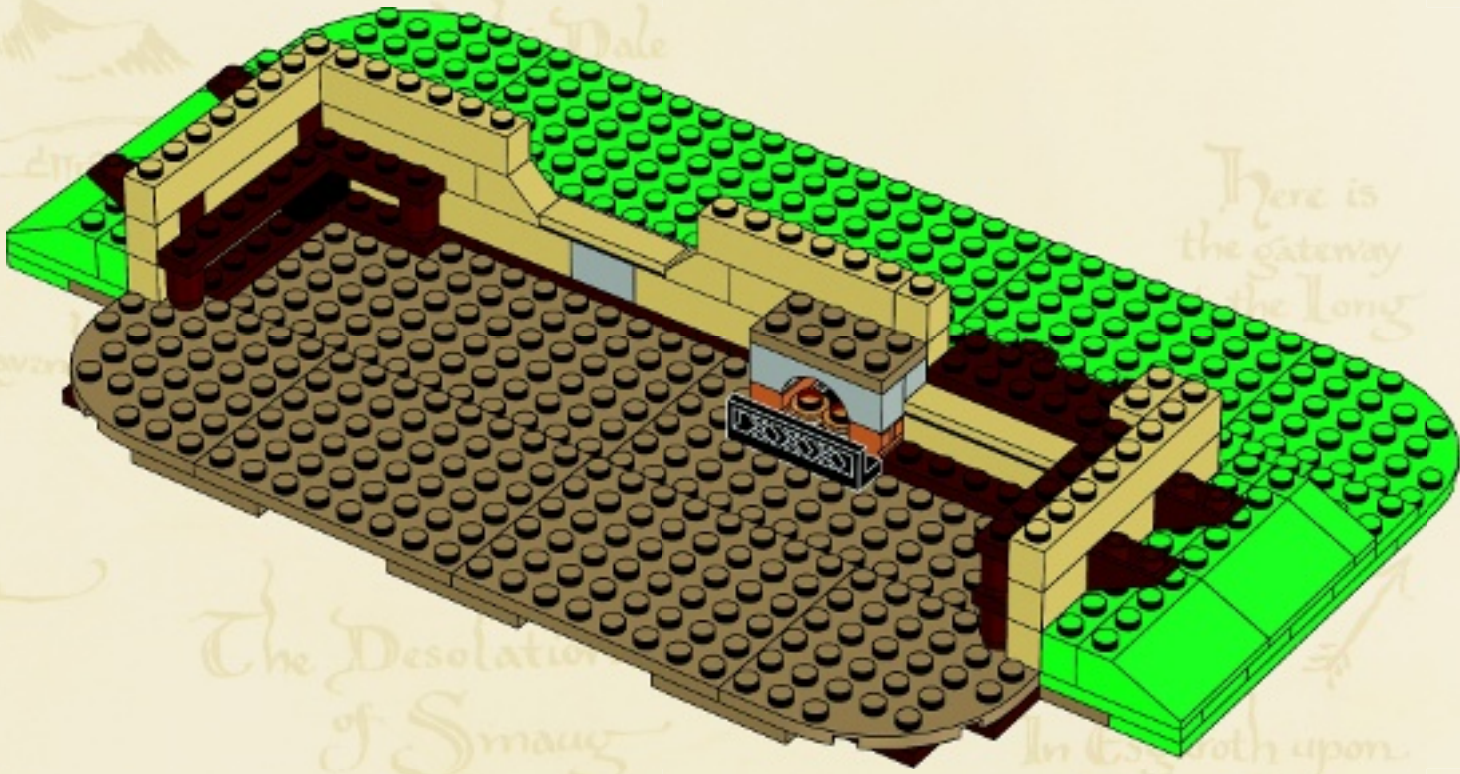

*Iron Hills*  
*where is Dain?*  
*Here was Girion's Dale*  
*Here is the gateway to the Long Lake*  
*The Desolation of Smaug*  
*In Gorthorn upon the Long Lake dwell Men*



2x



1x

33

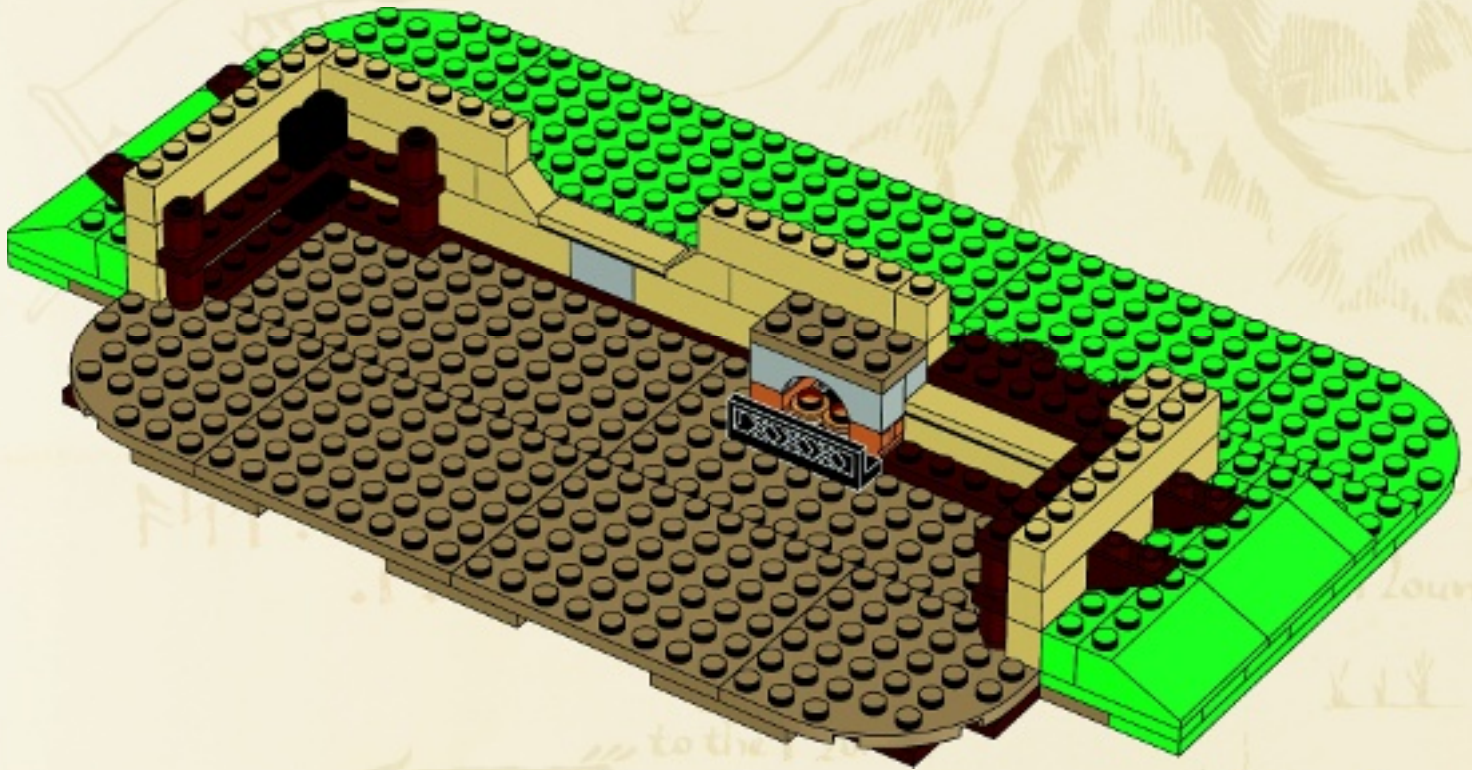

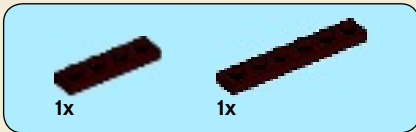

34

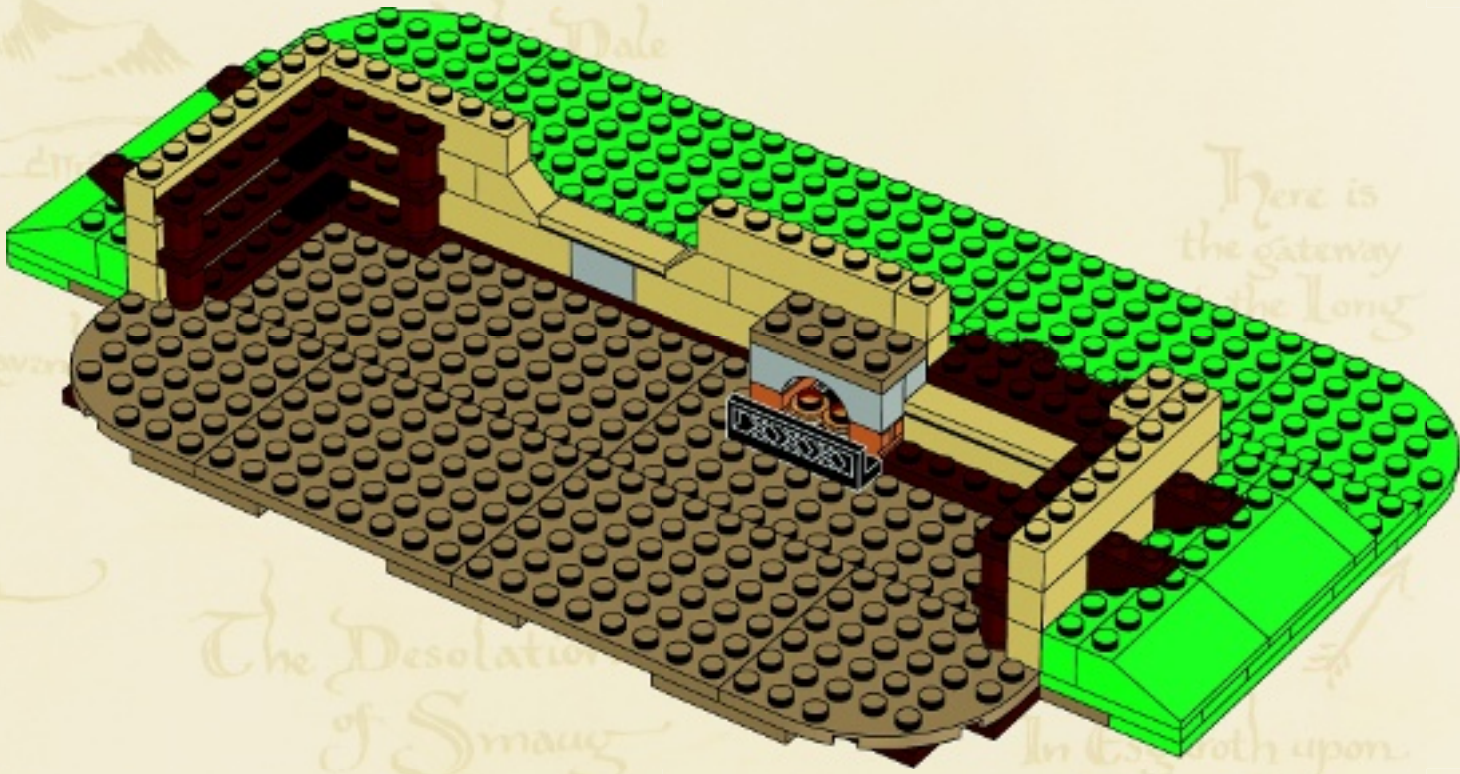

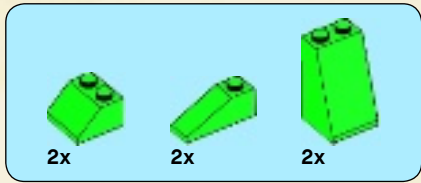

35

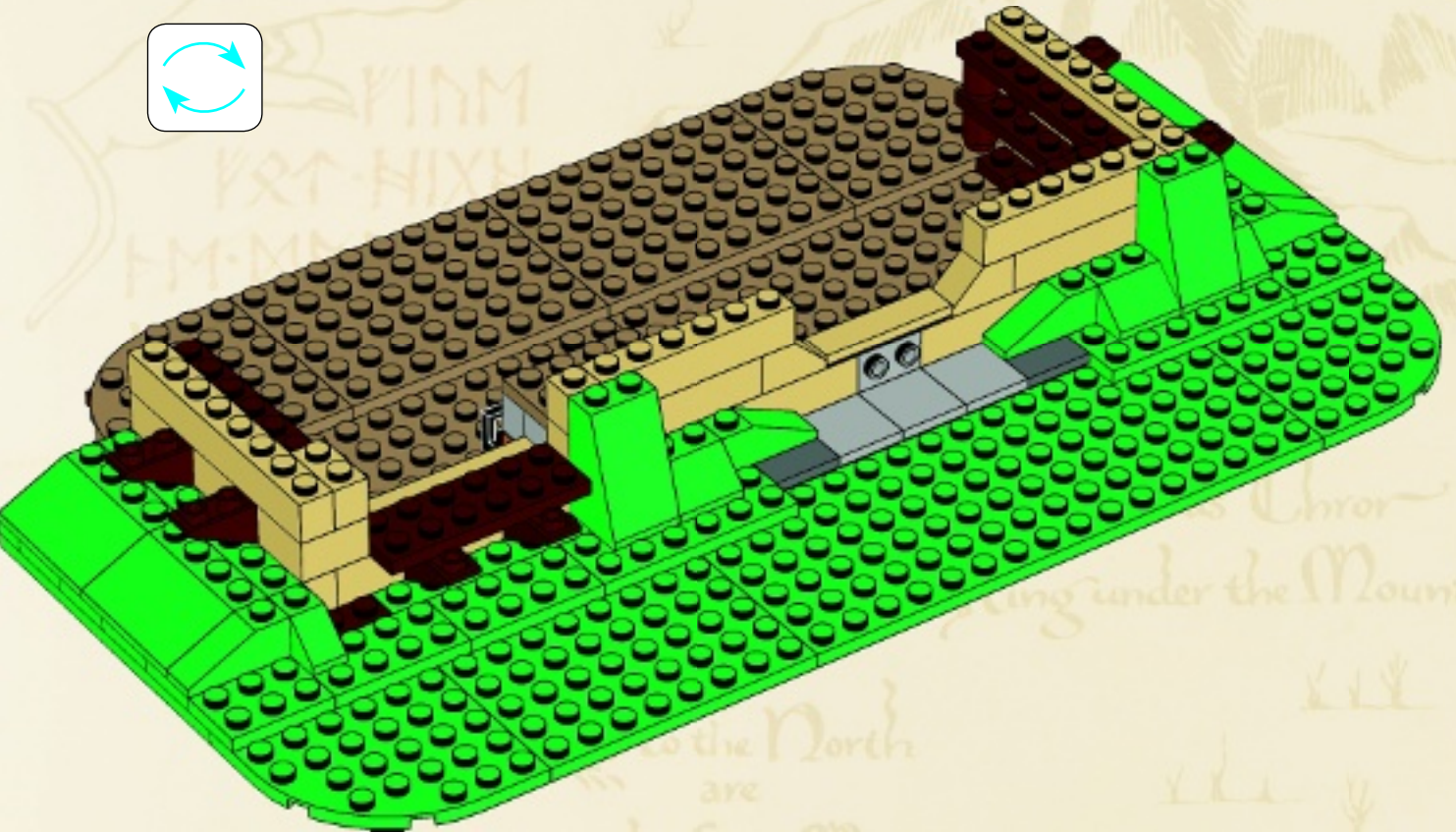

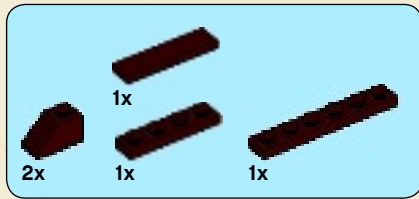

36

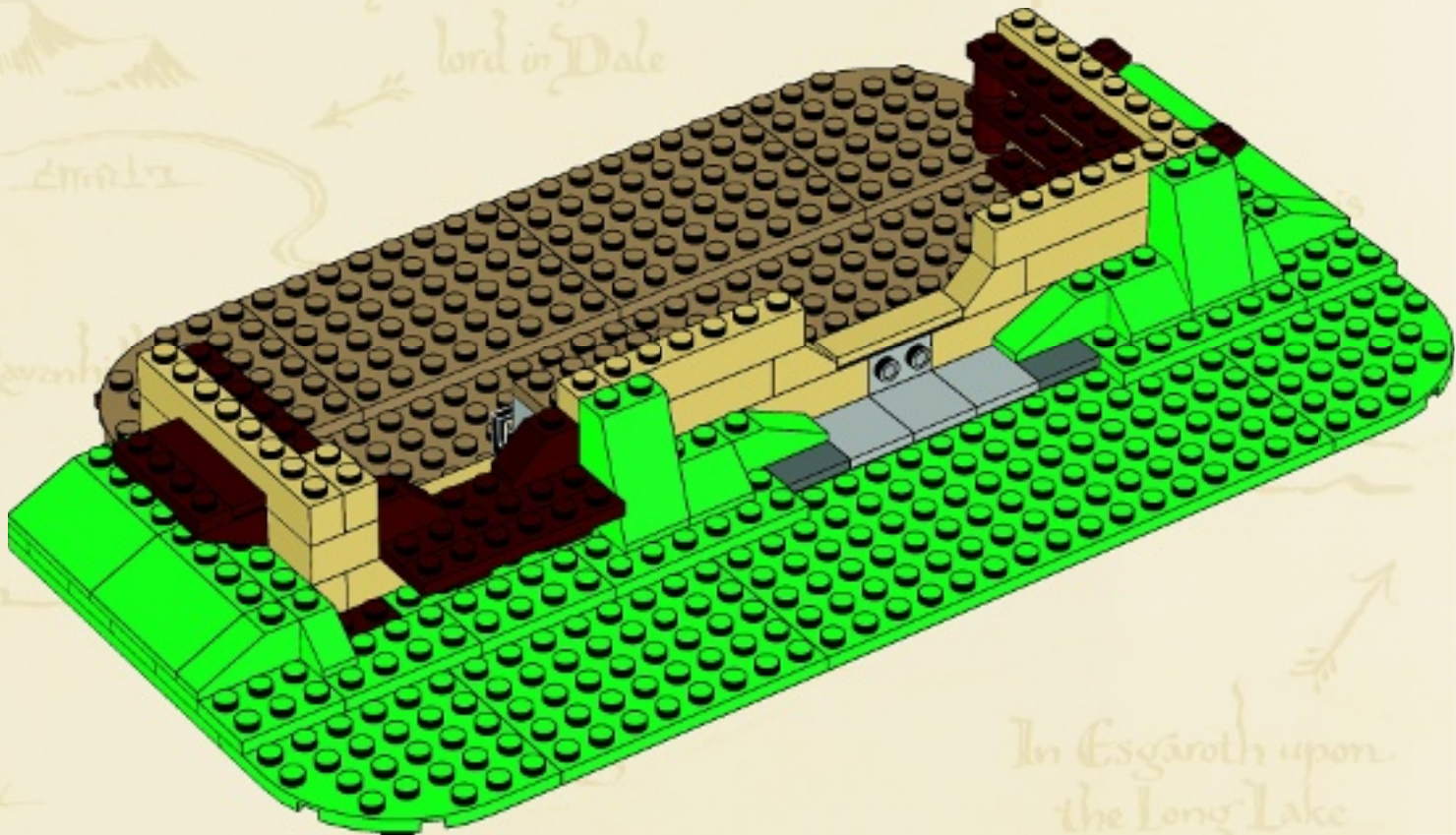



2x



2x

# 37

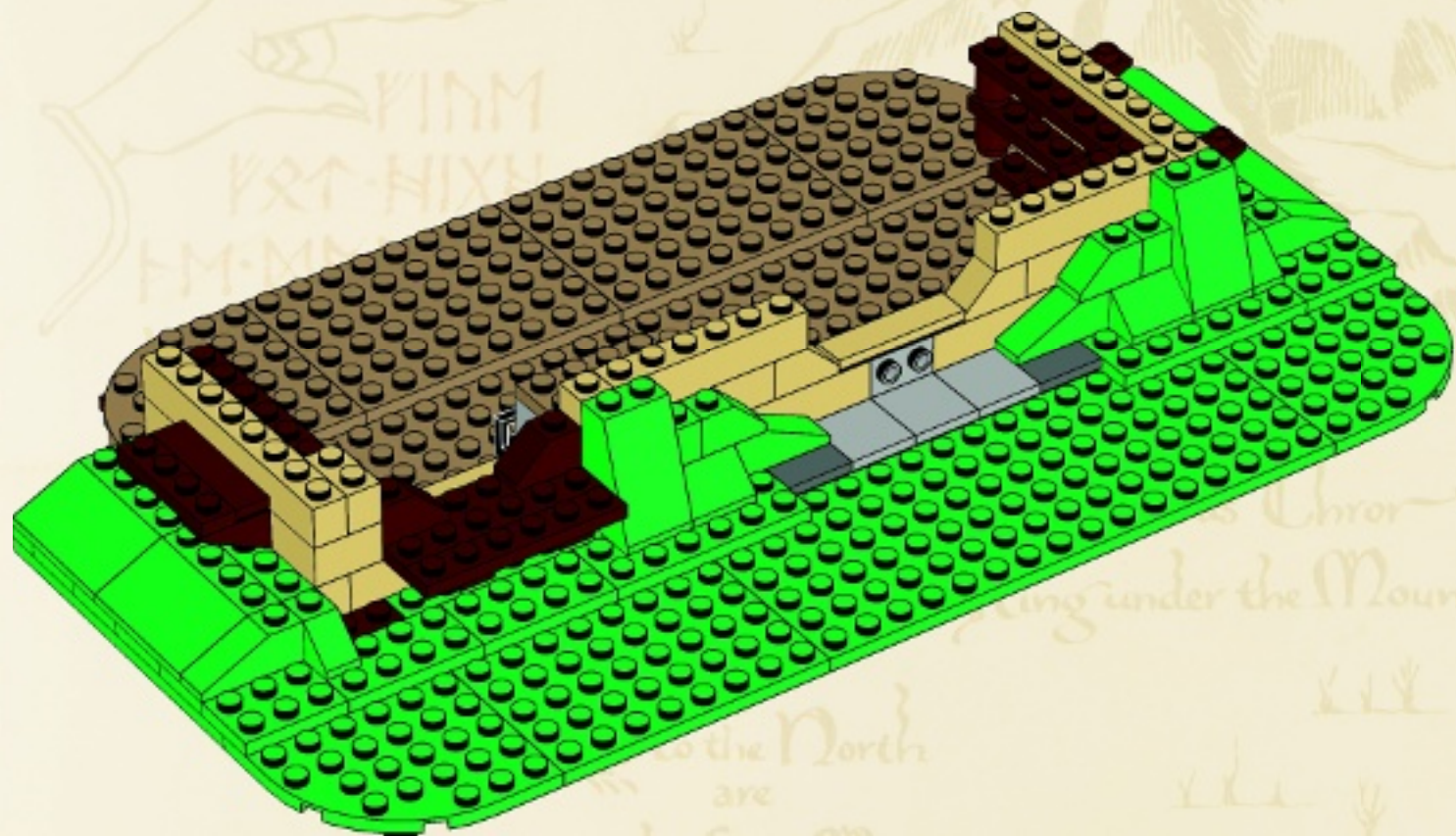

The  
 Lonely  
 Mountain

to the North  
 are  
 the Grey Mountains  
 &  
 the Withered Heath  
 whence came the

Chror  
 ing under the Mount



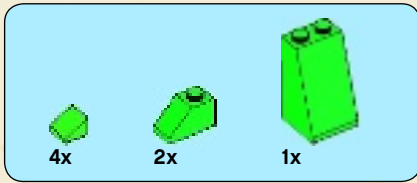

38

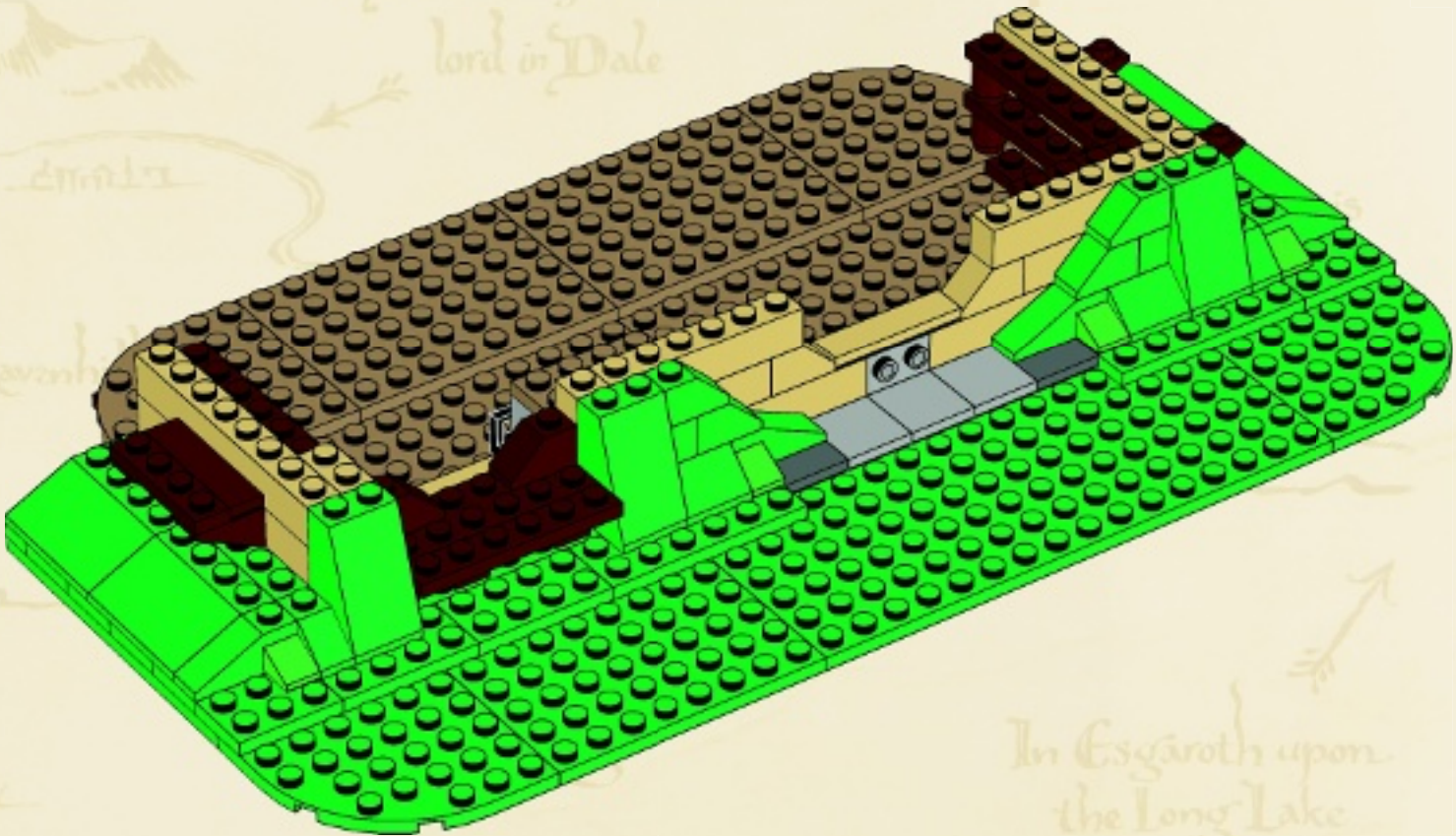

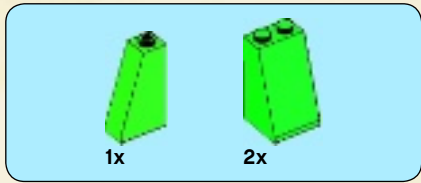

39

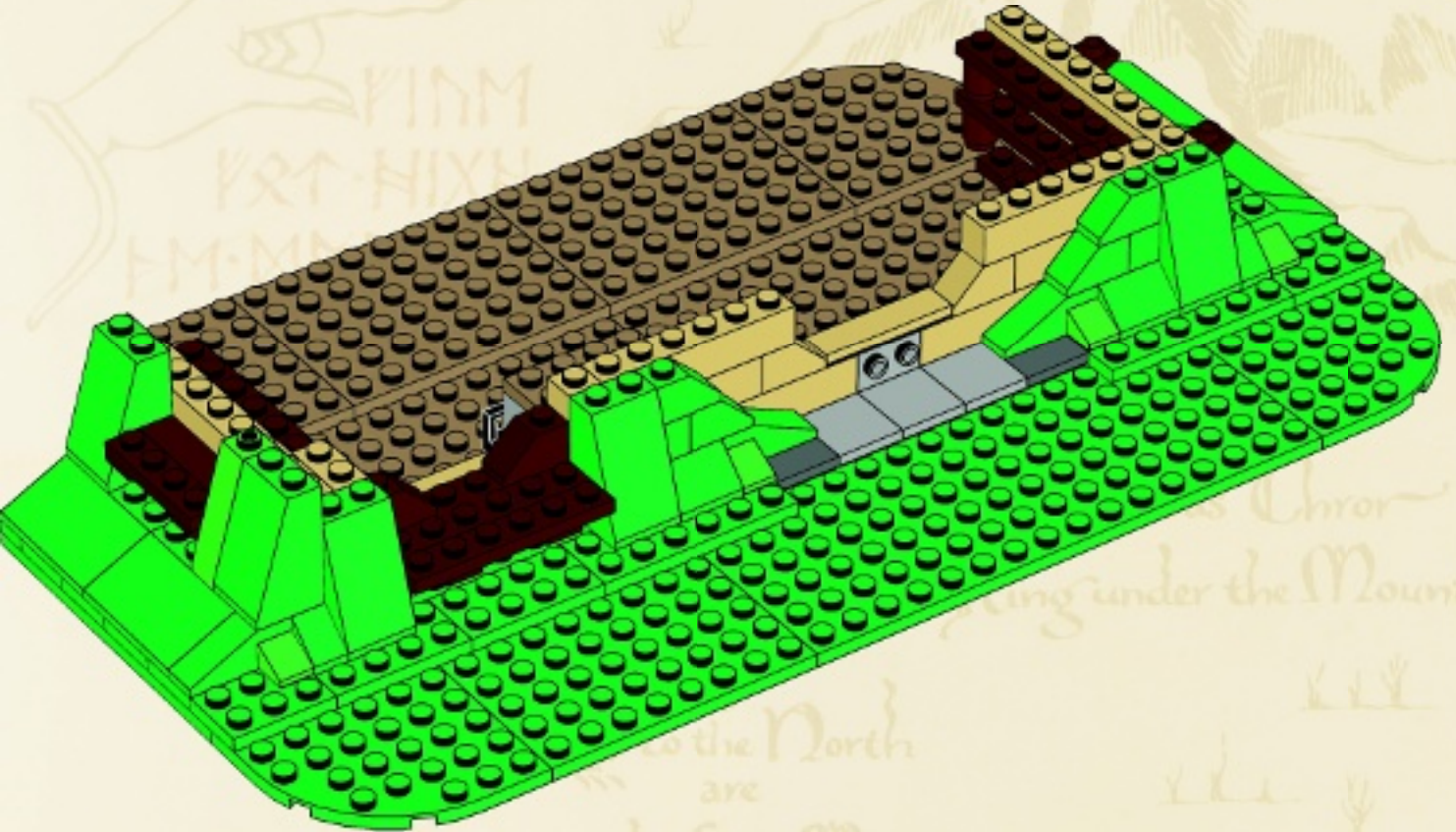

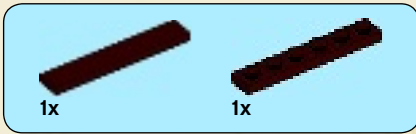

40

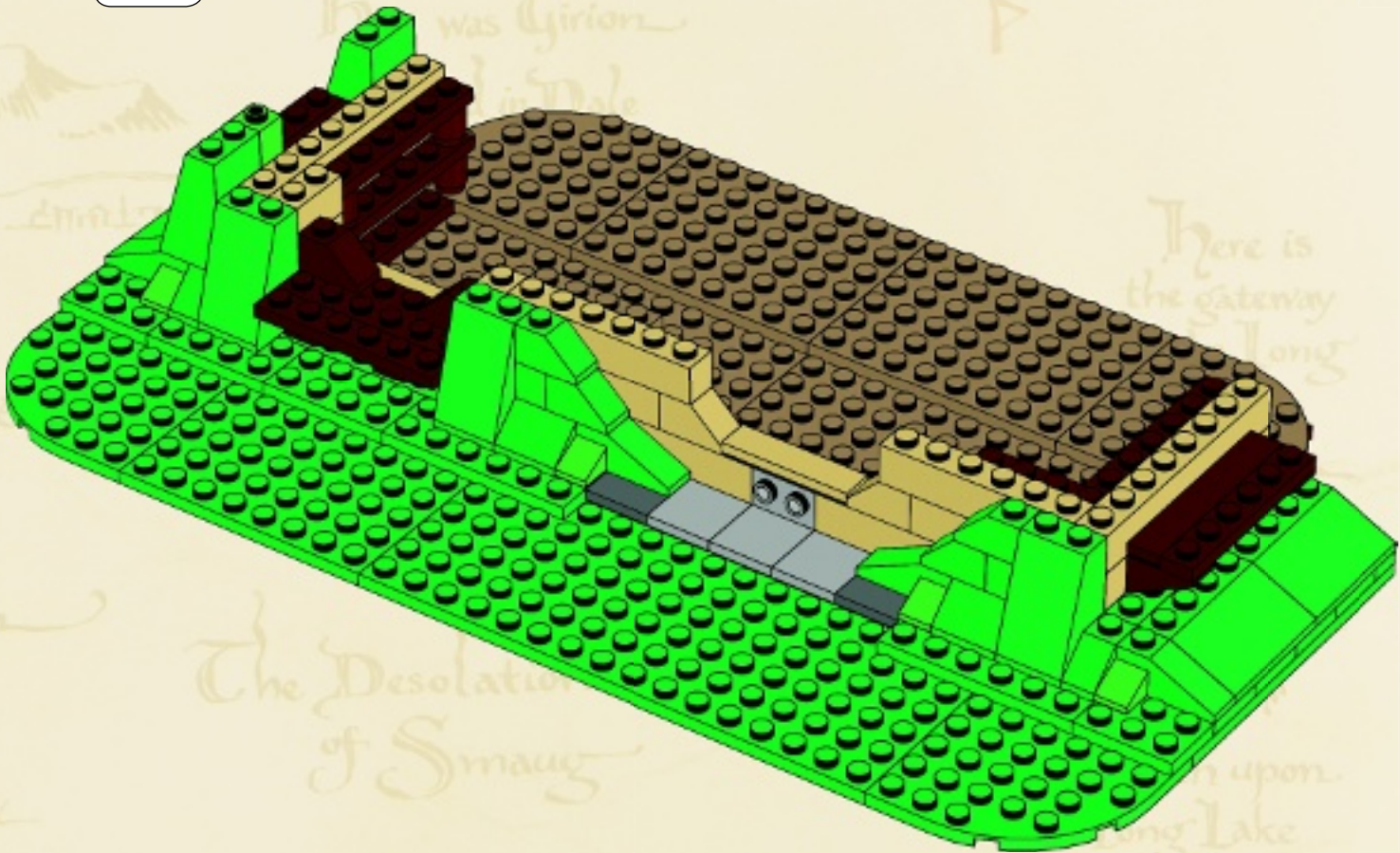

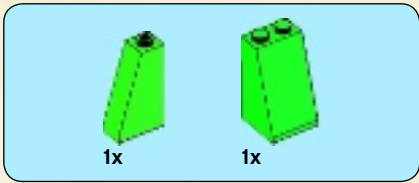

41

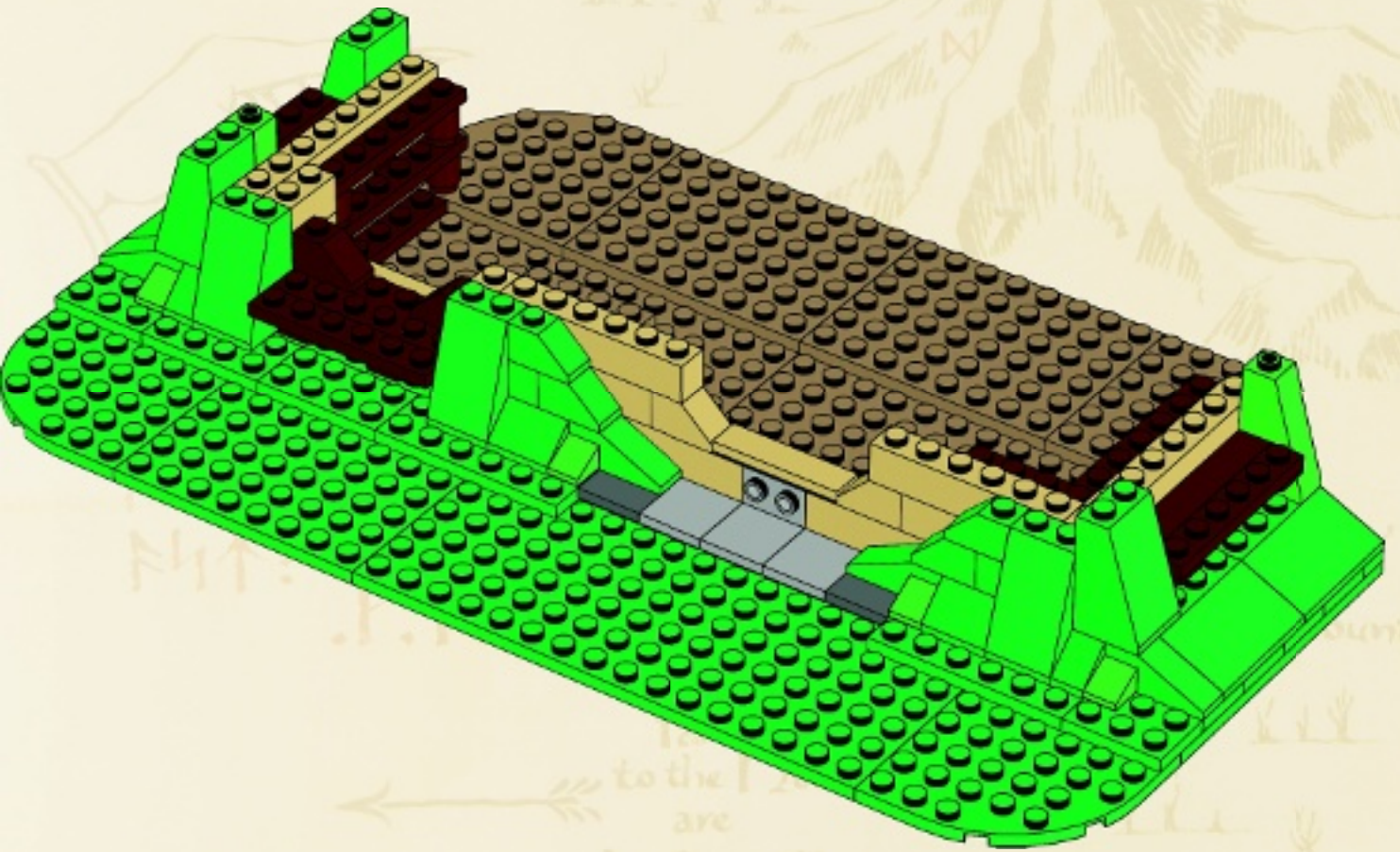

The  
Lonely  
Mountain

to the  
are  
the Grey Mountains  
&  
the Withered Heath  
whence came the

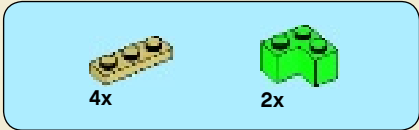
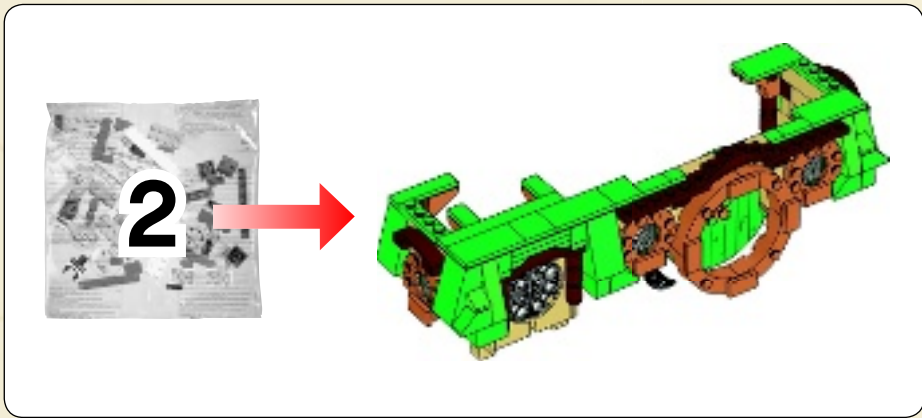

42

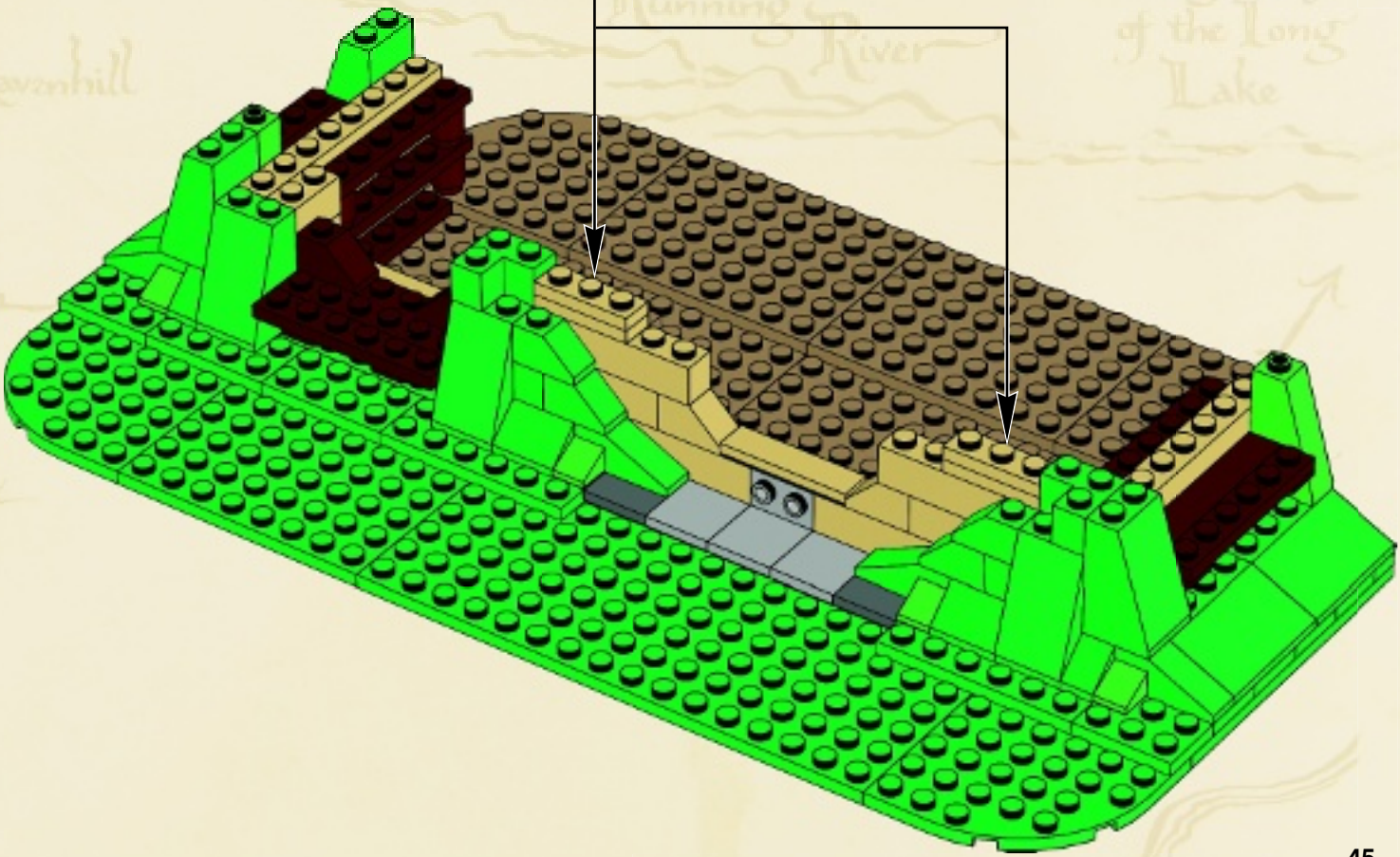
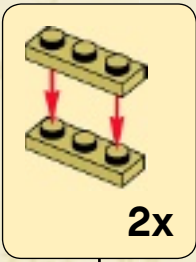

		
1x	1x	2x

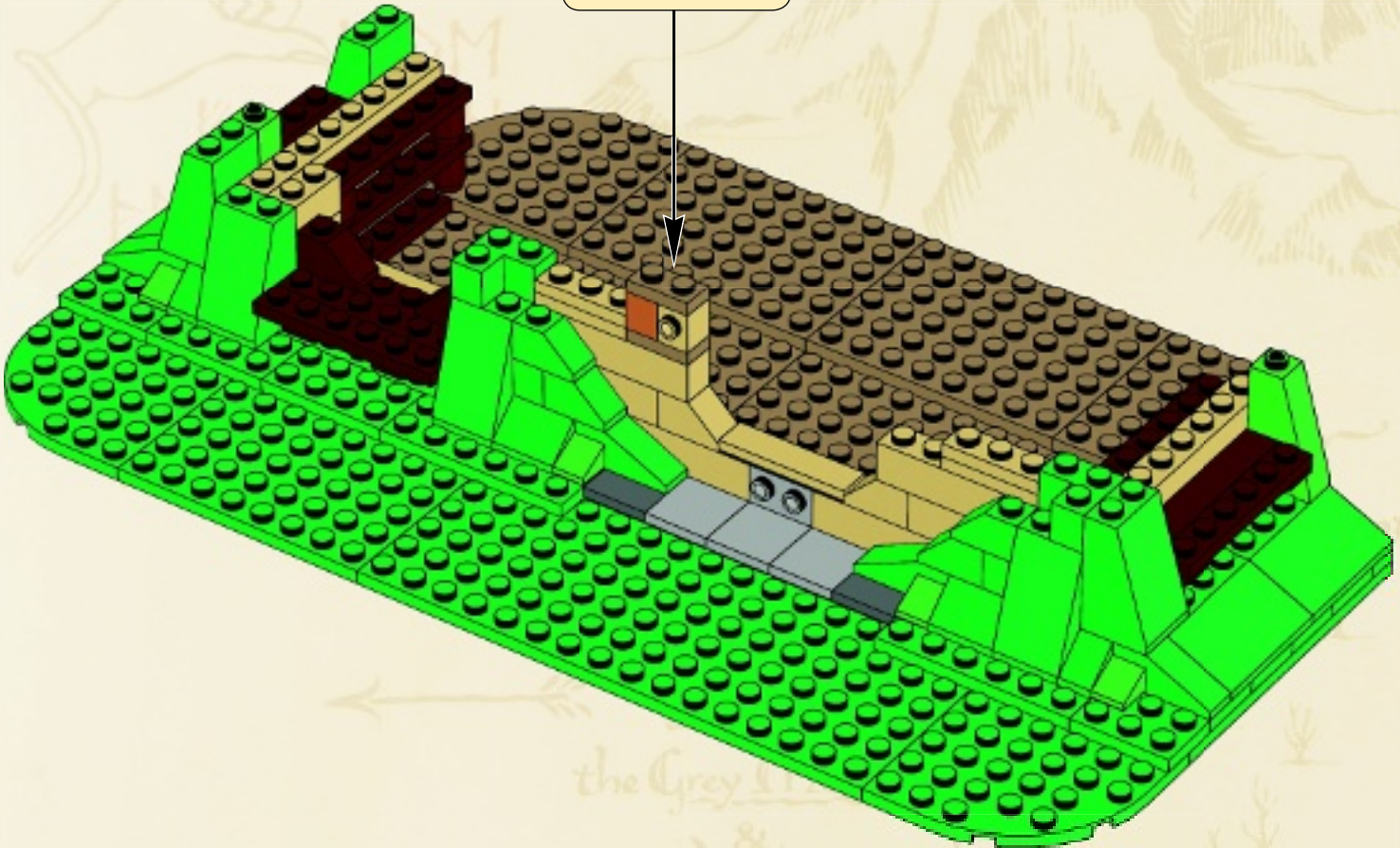

# 43

- 1 
- 2 
- 3 



1x 1x 2x

# 44

- 1 
- 2 
- 3 

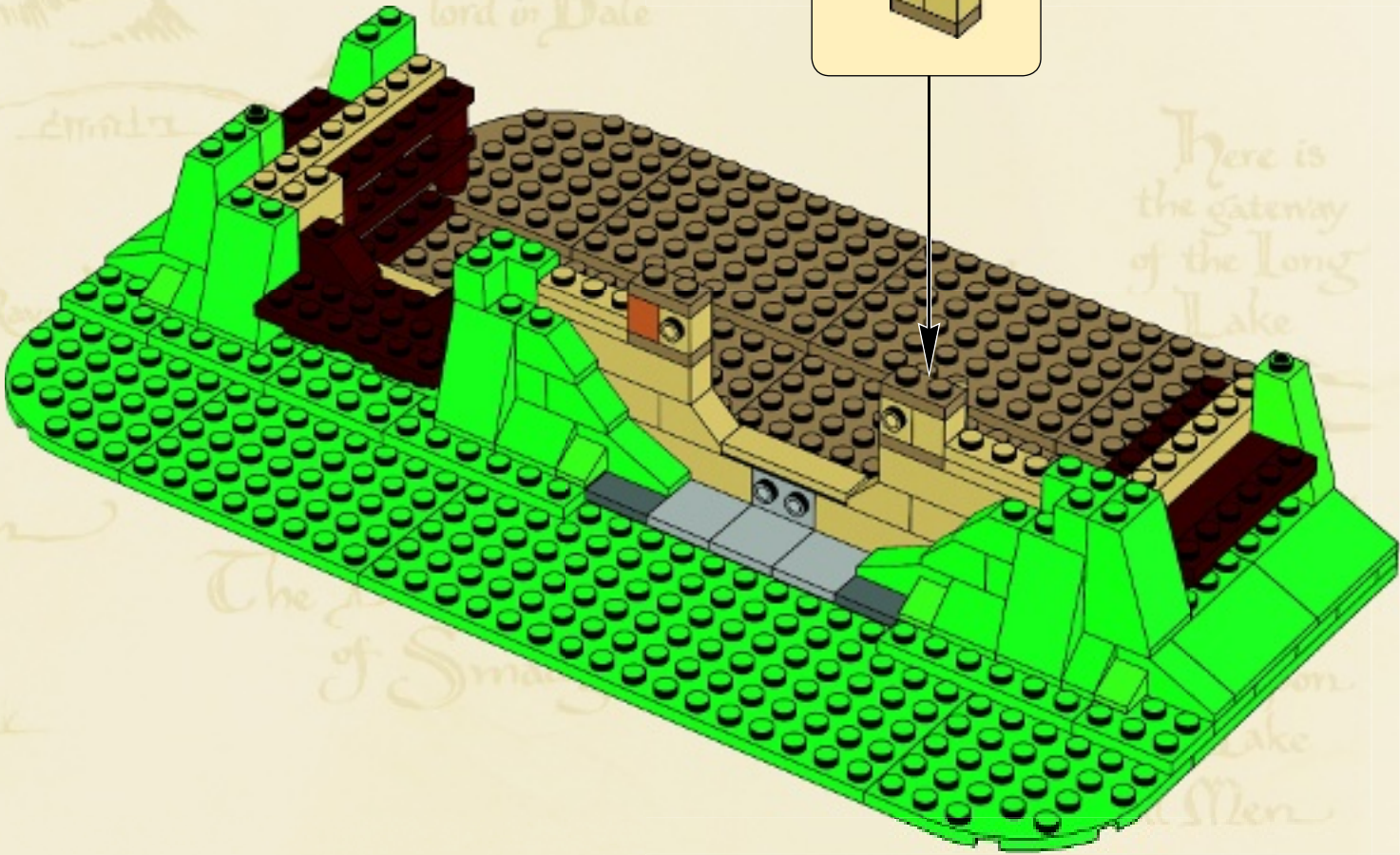

		
2x	2x	1x

# 45

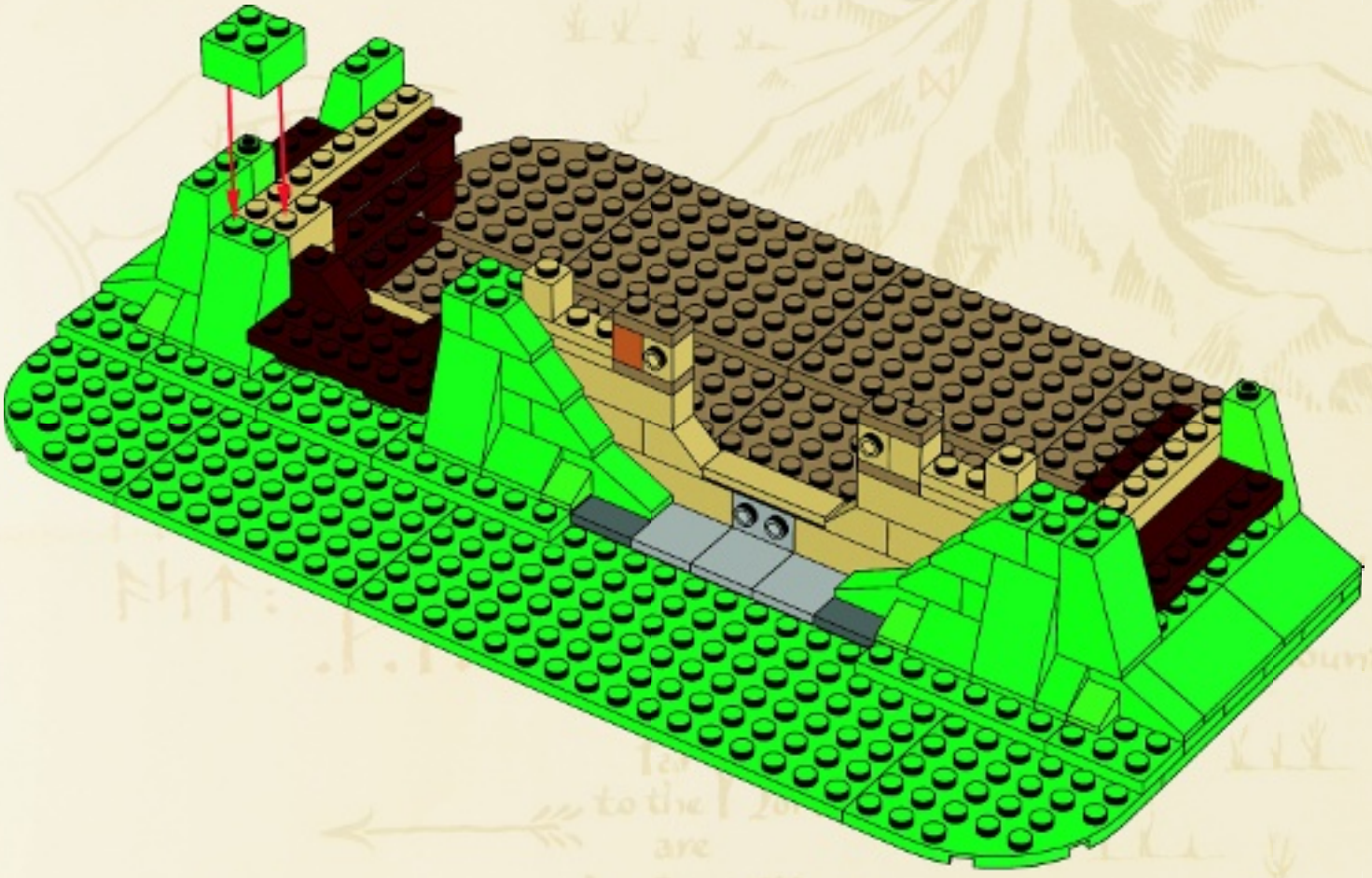





2x



2x

# 46

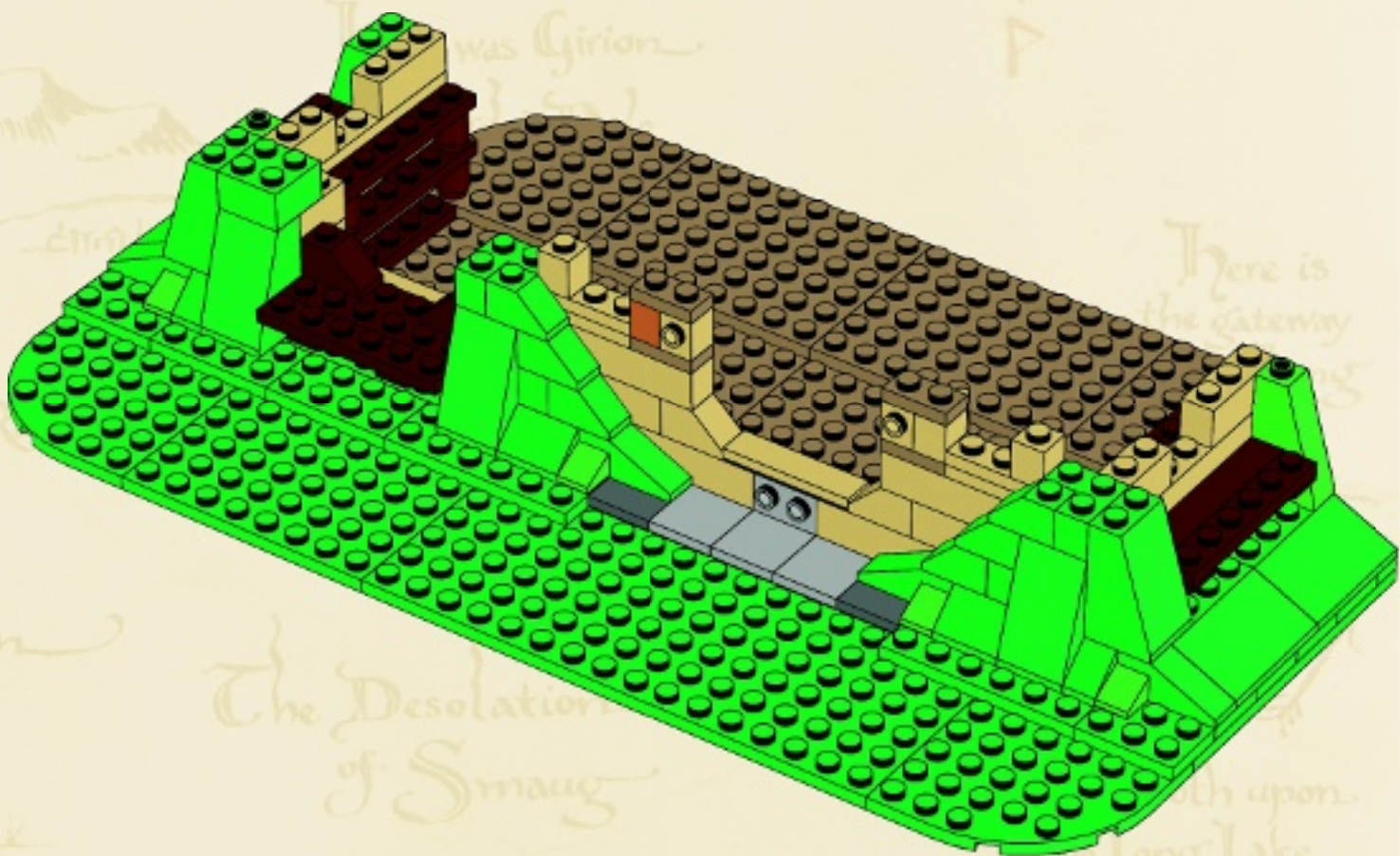

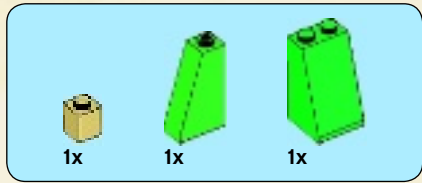

47

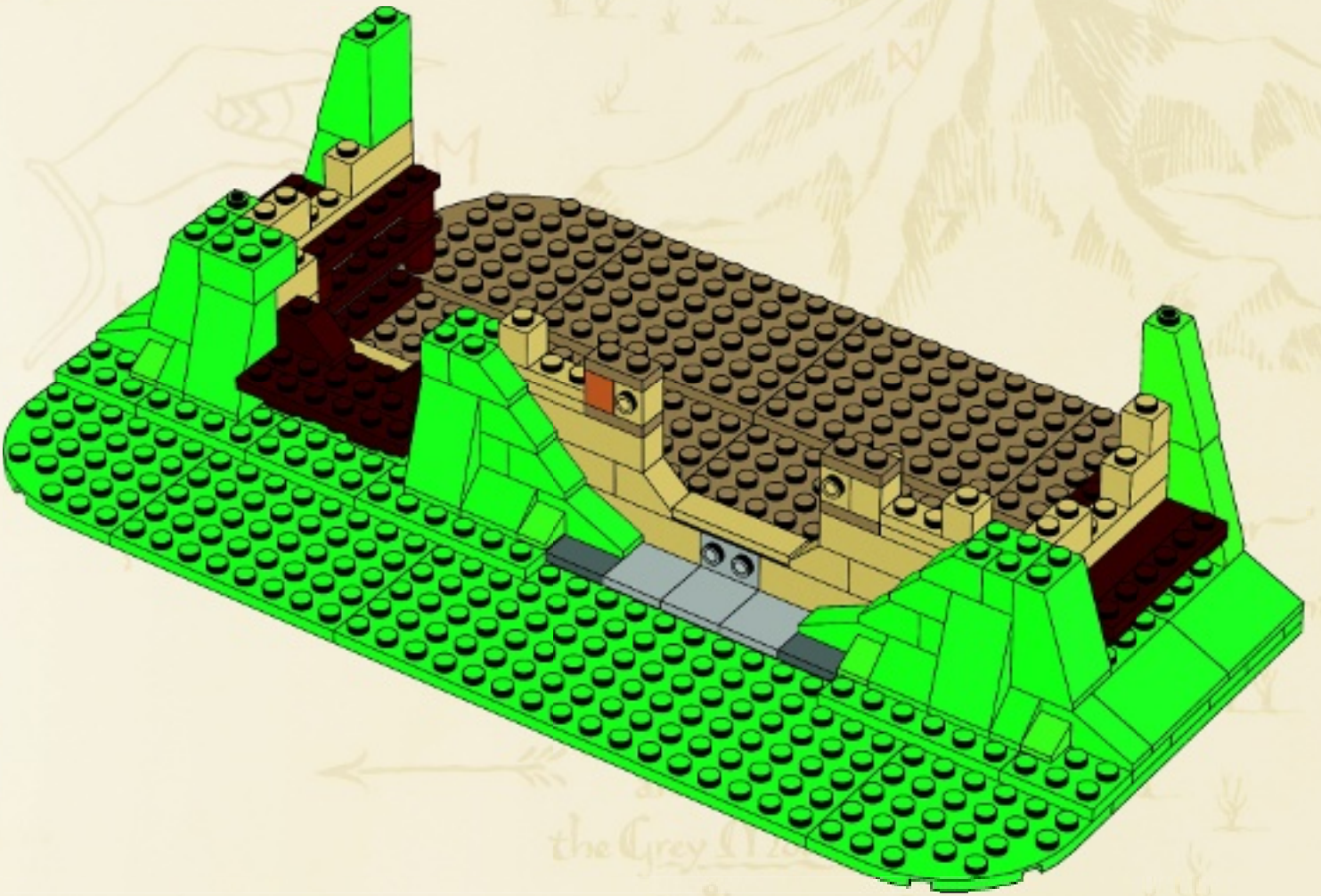



48

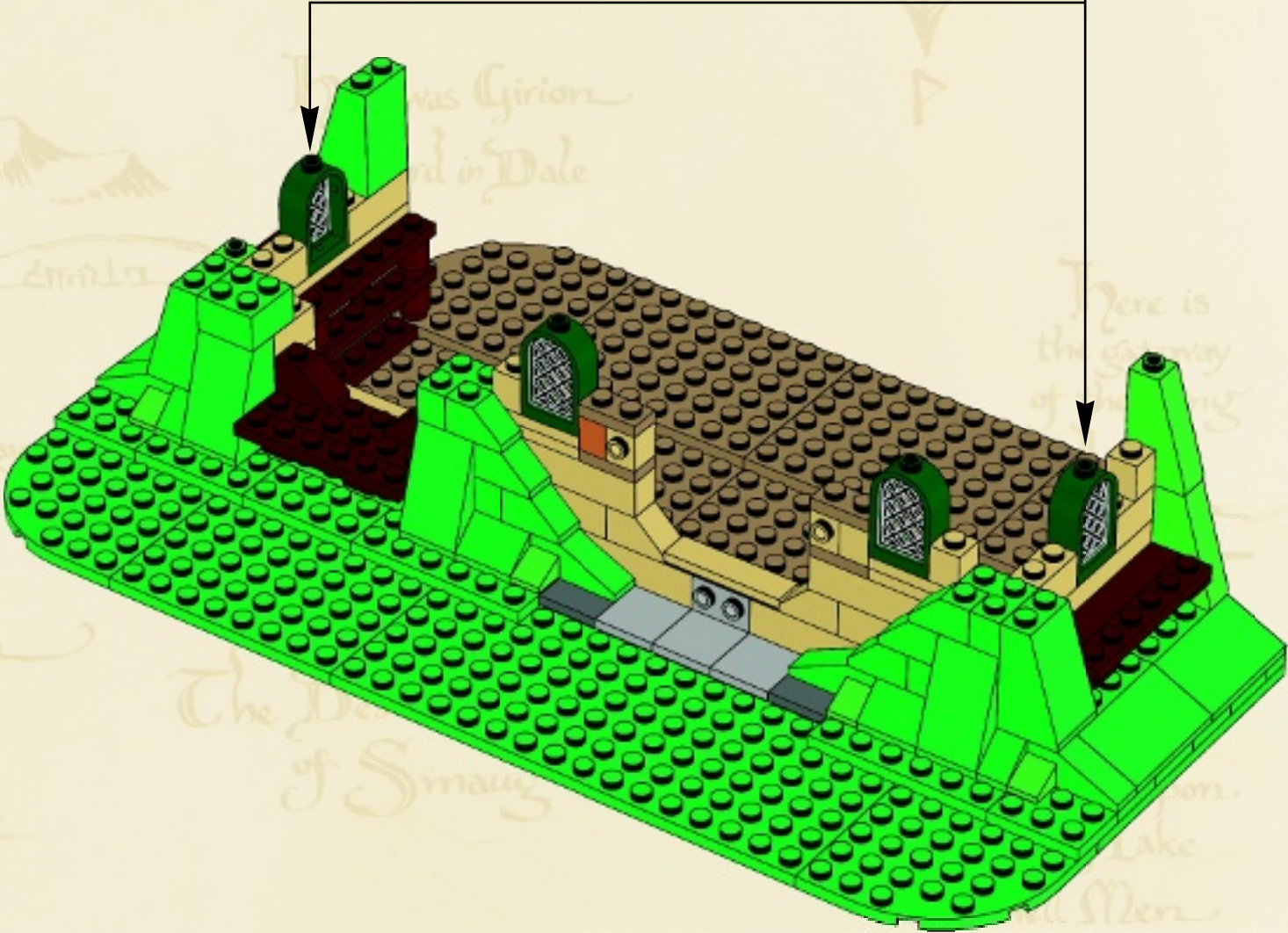



49

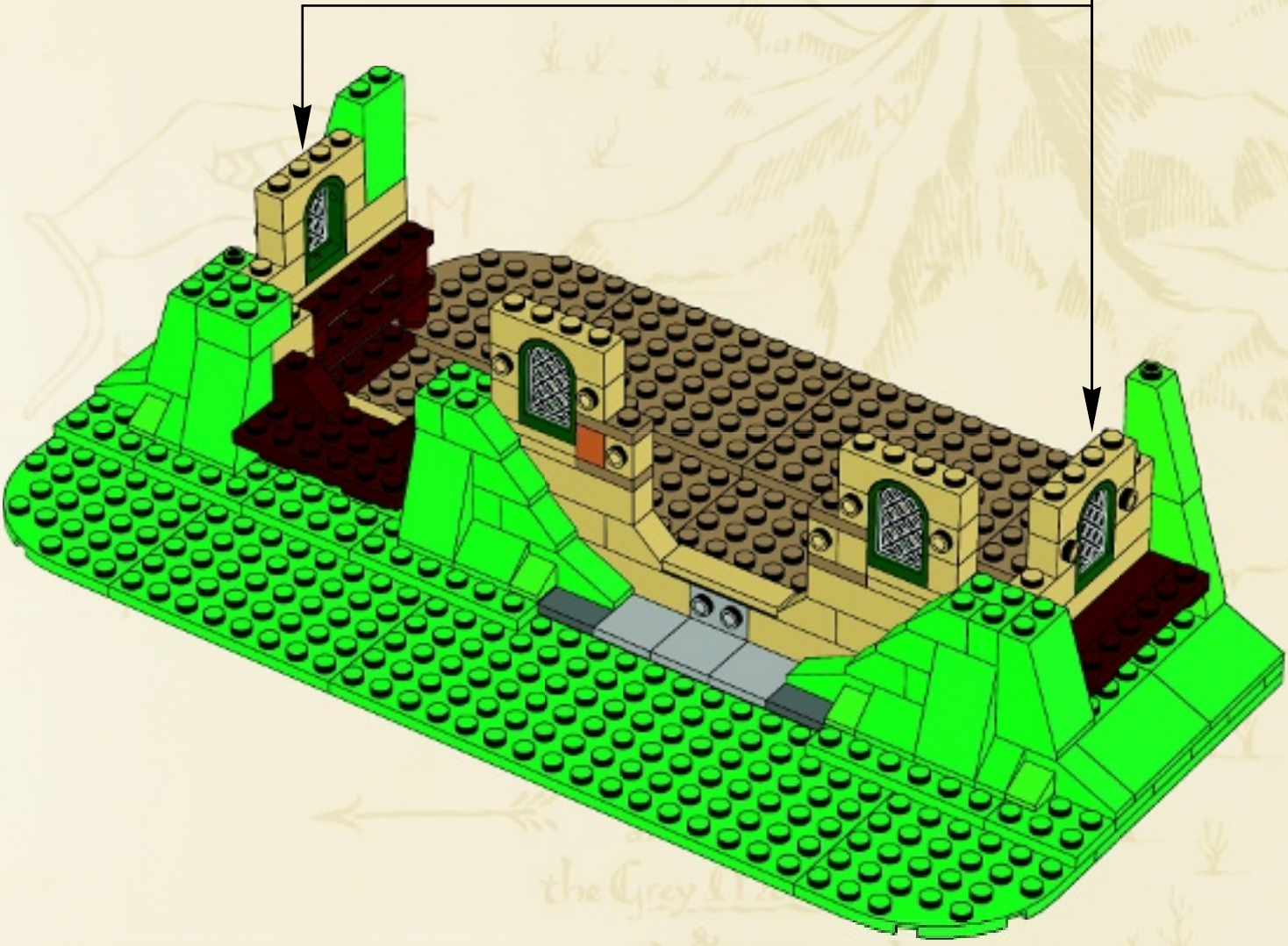
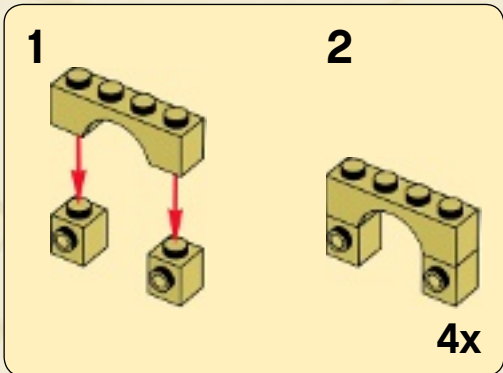



1x



2x

# 50

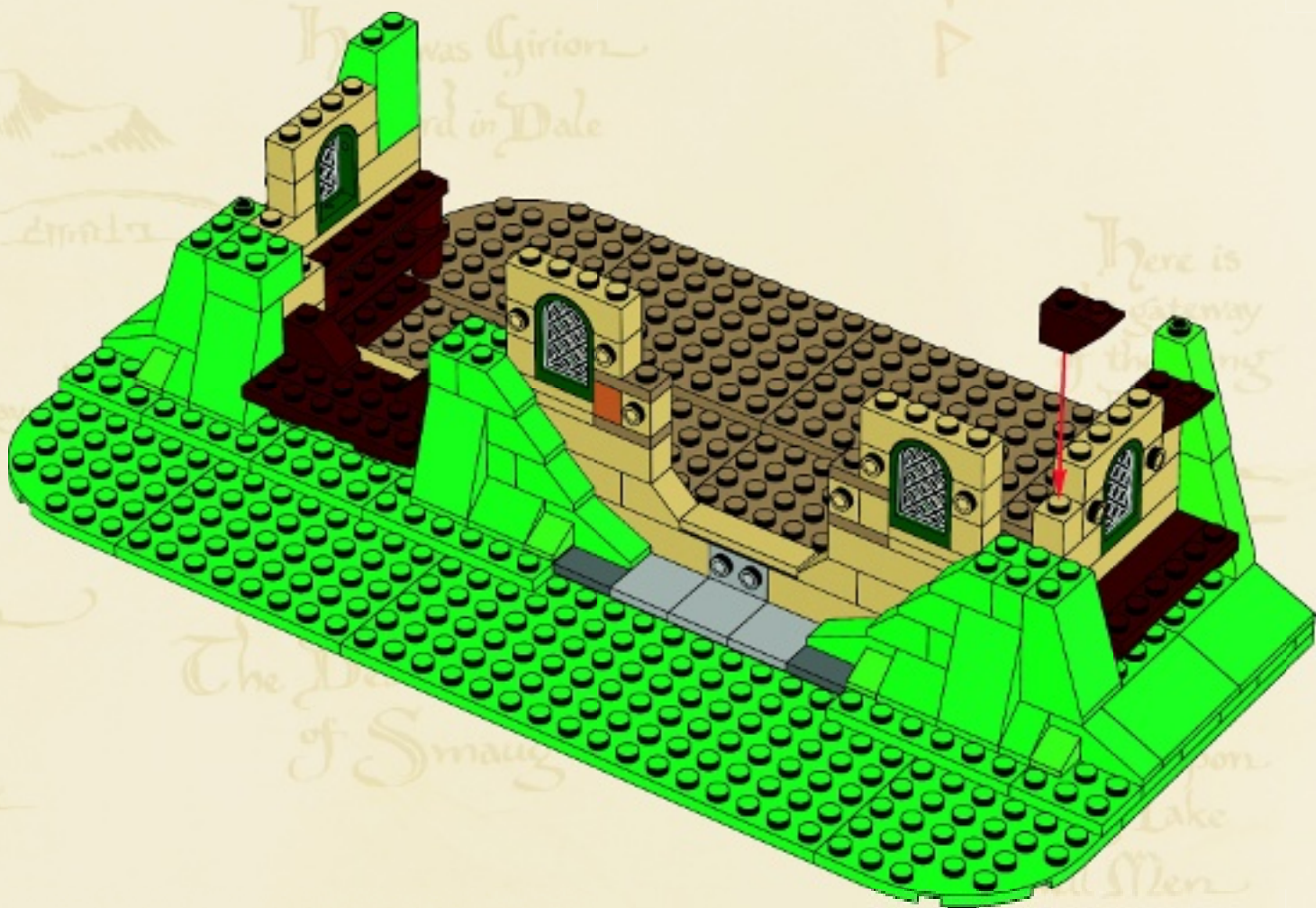

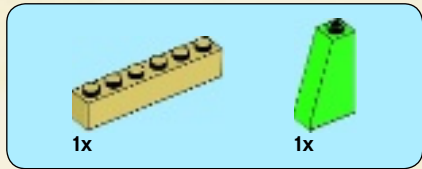

51

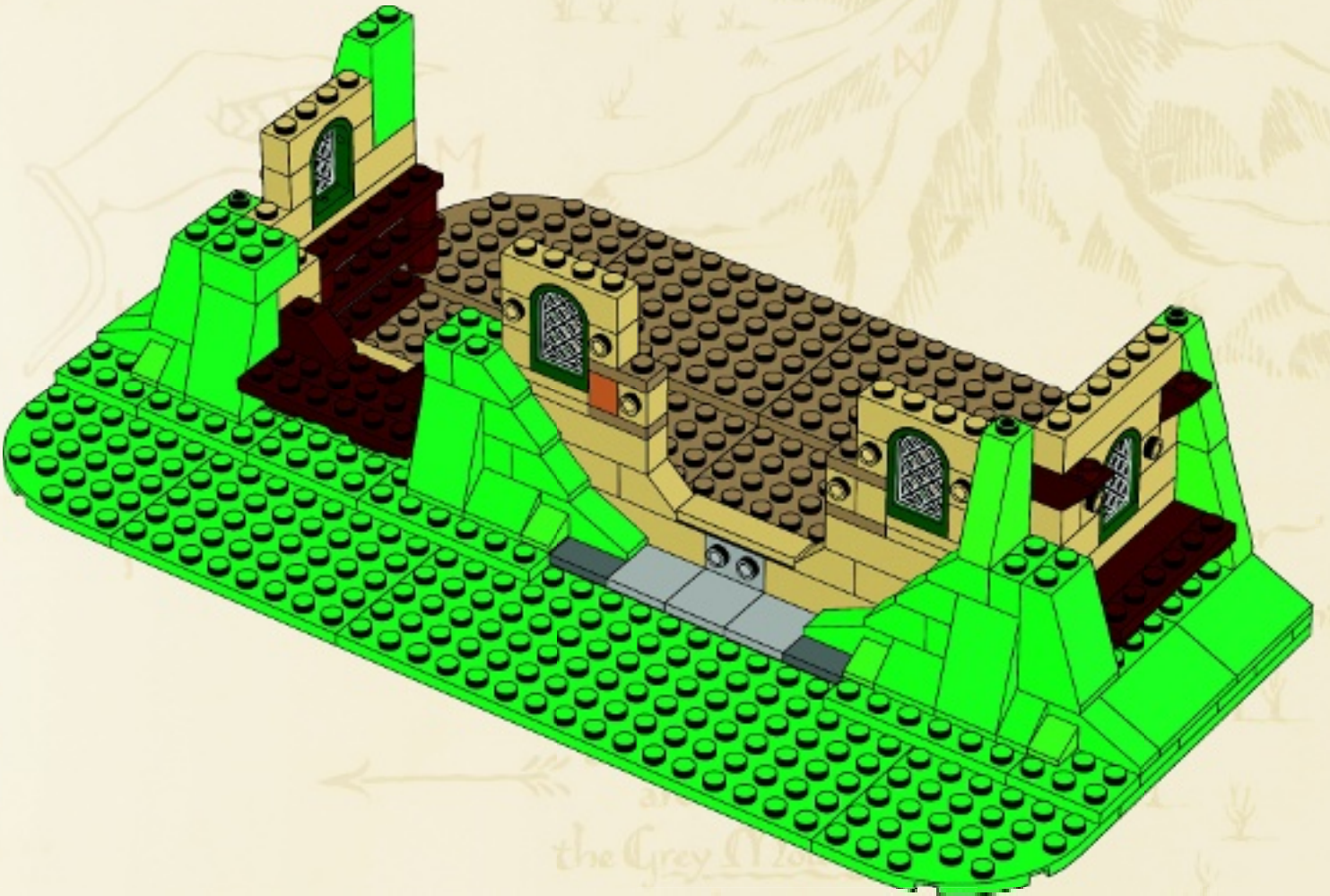

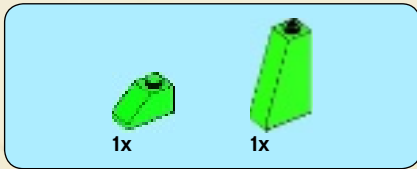

52

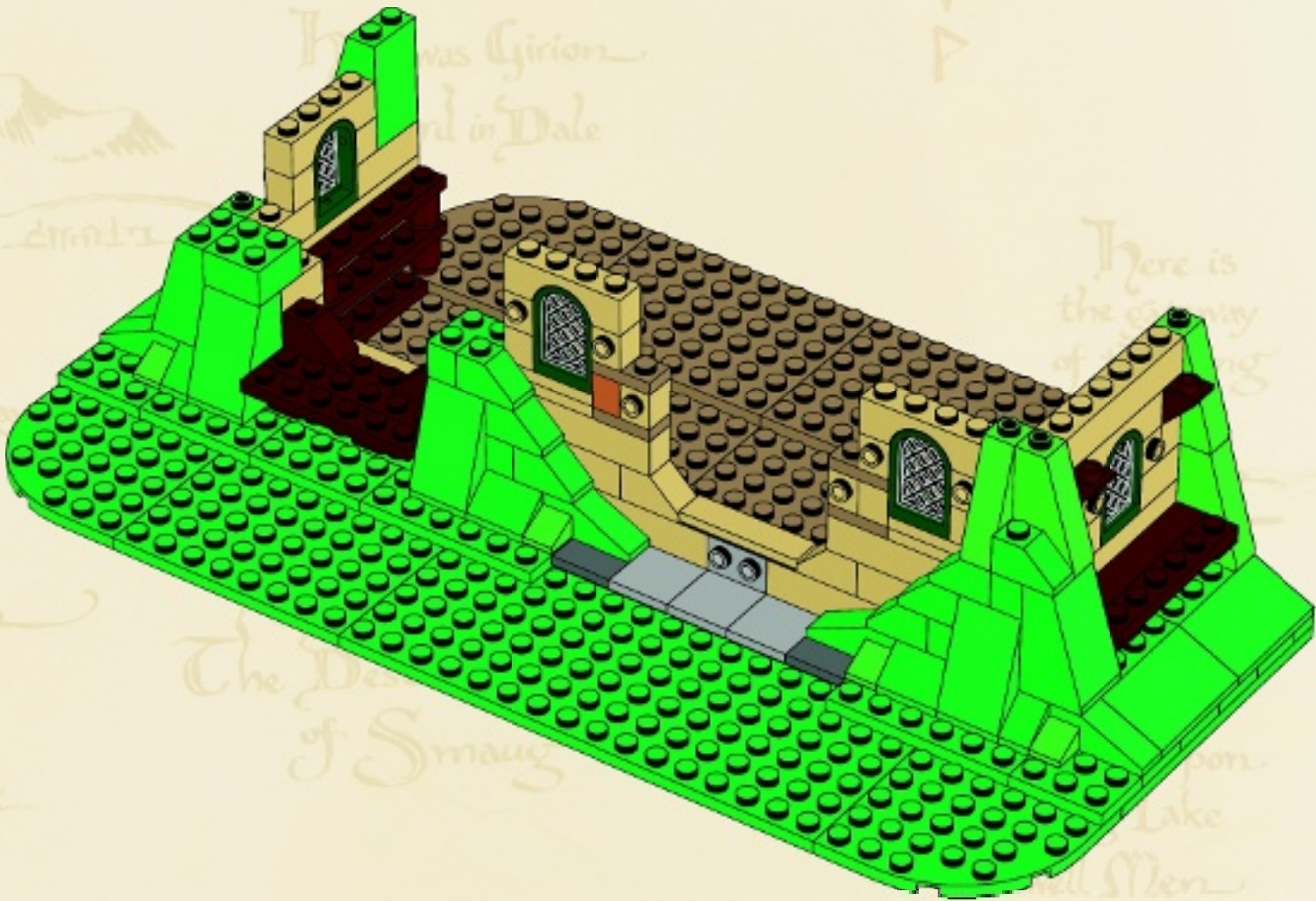



1x



2x

# 53

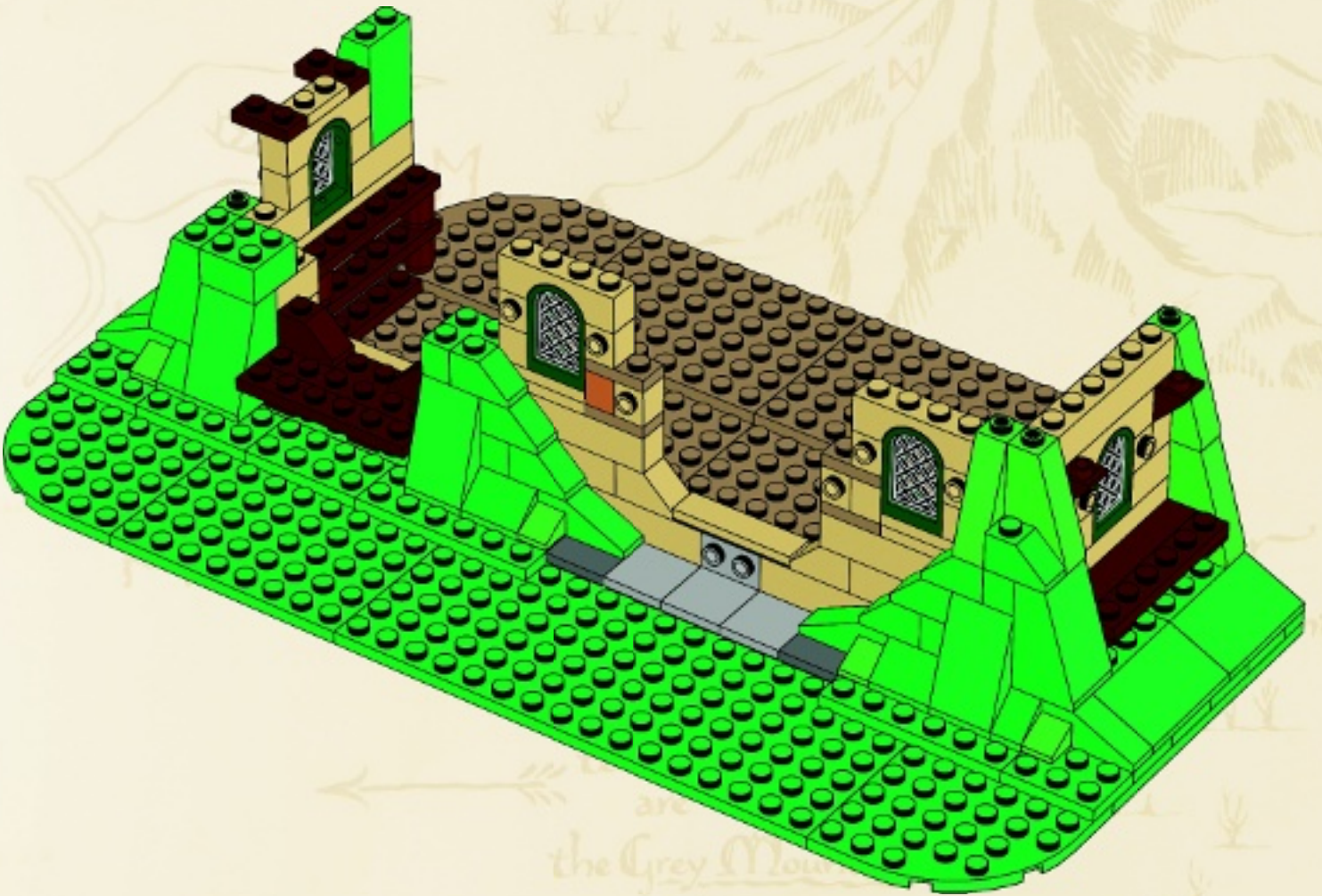



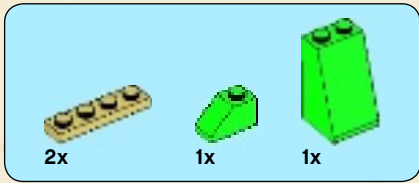

54

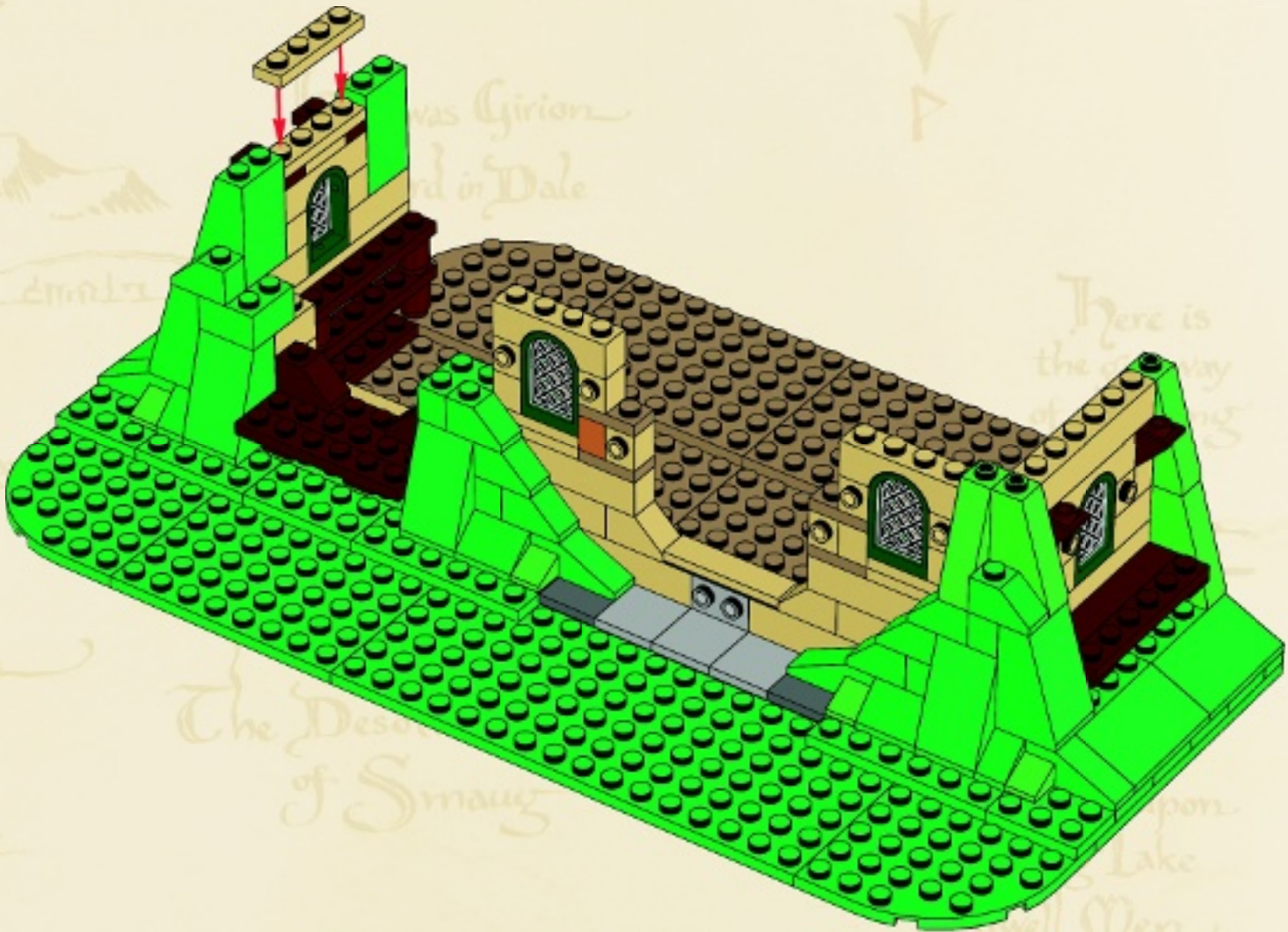

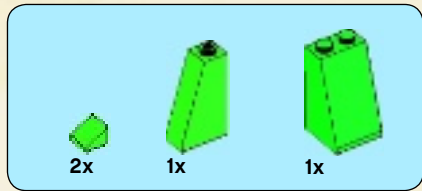

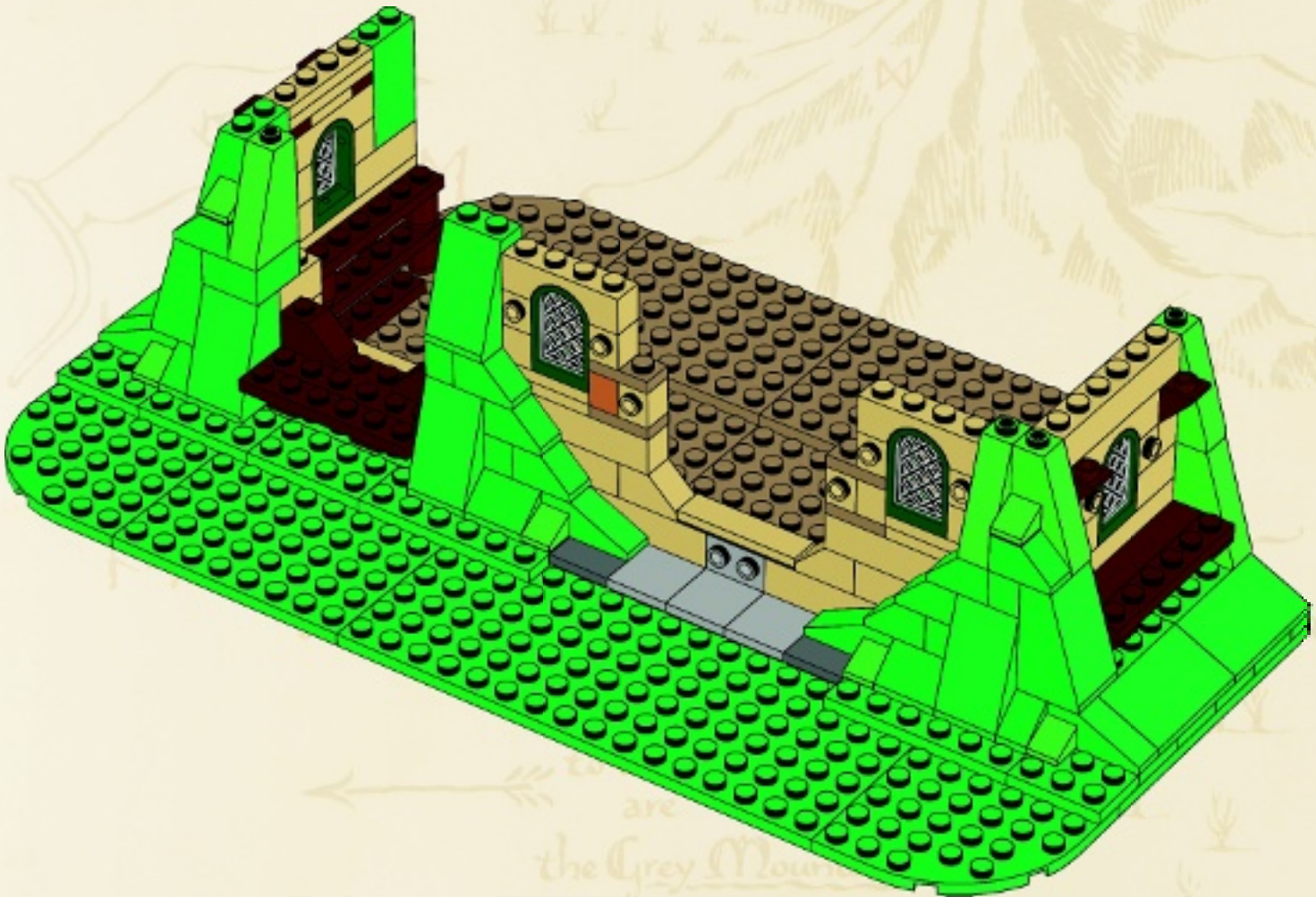

55

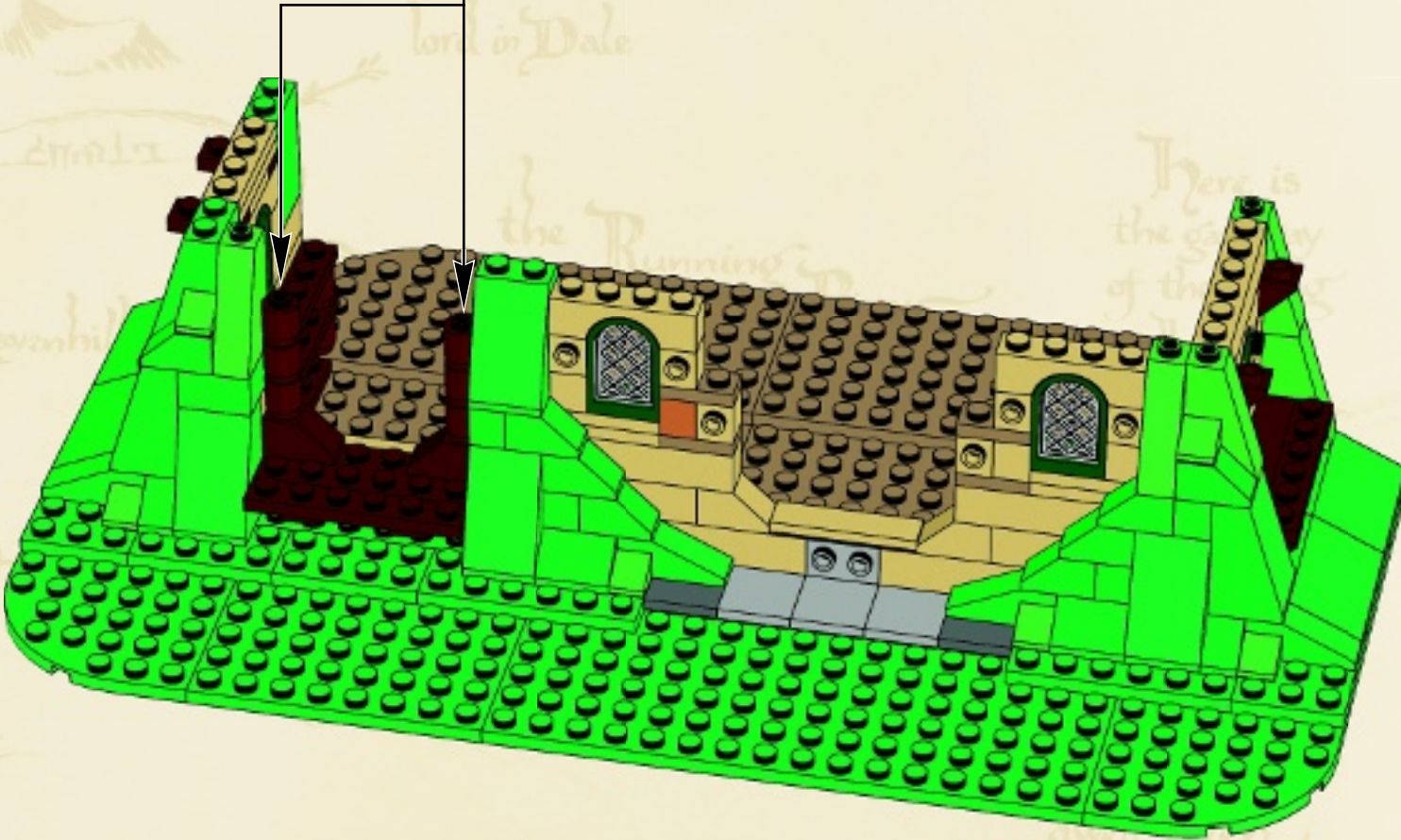
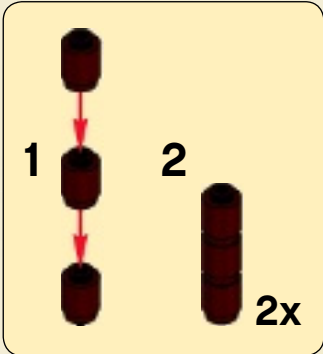

6x

# 56



2x  1x 

# 57

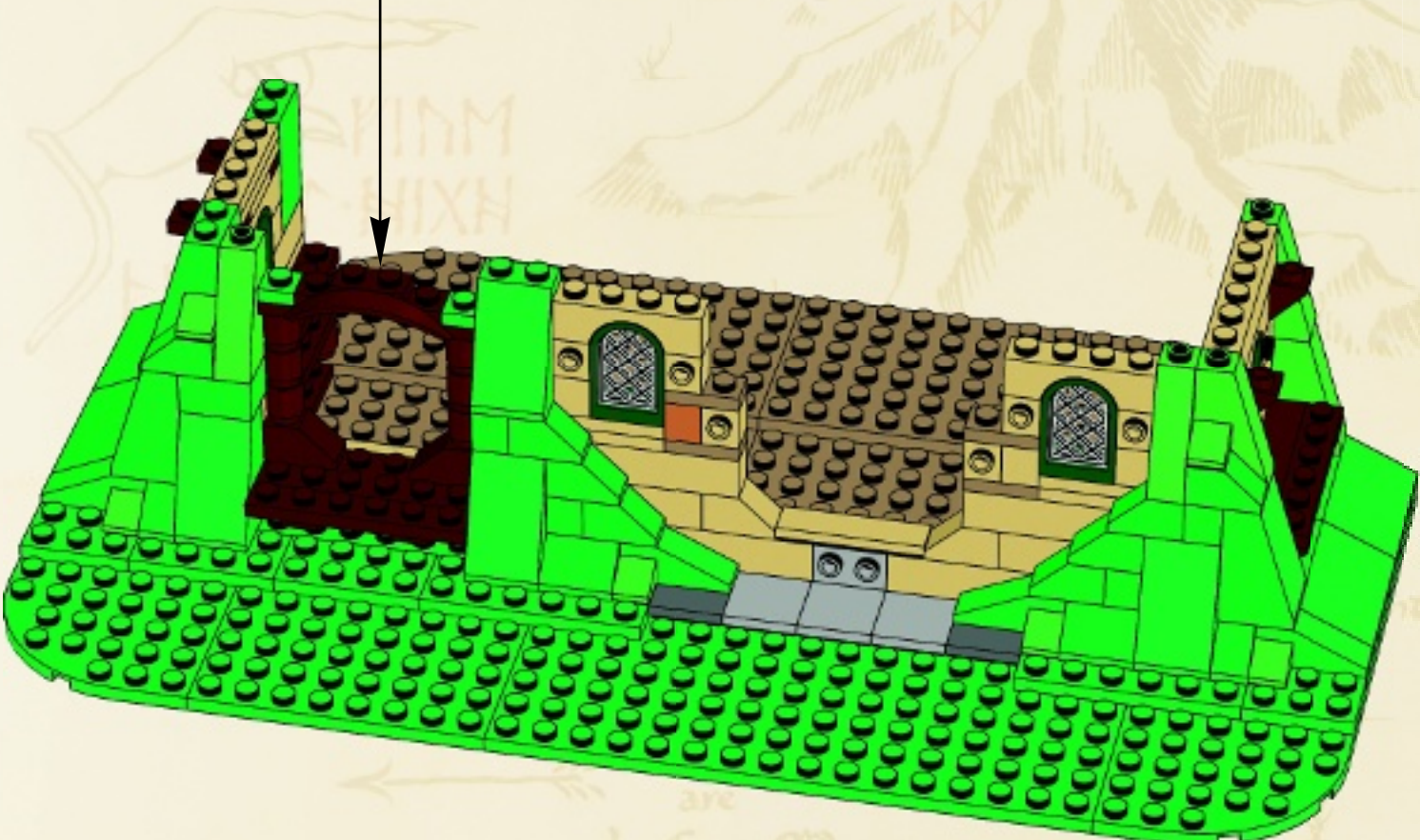

1 

2 







The  
Lovely  
Mountain

are  
the Grey Mountains  
&  
the Withered Heath  
whence came the

 2x
  2x
  4x

# 58

- 1 
- 2 
- 3 

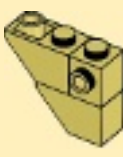
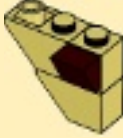
- 1 
- 2 
- 3 

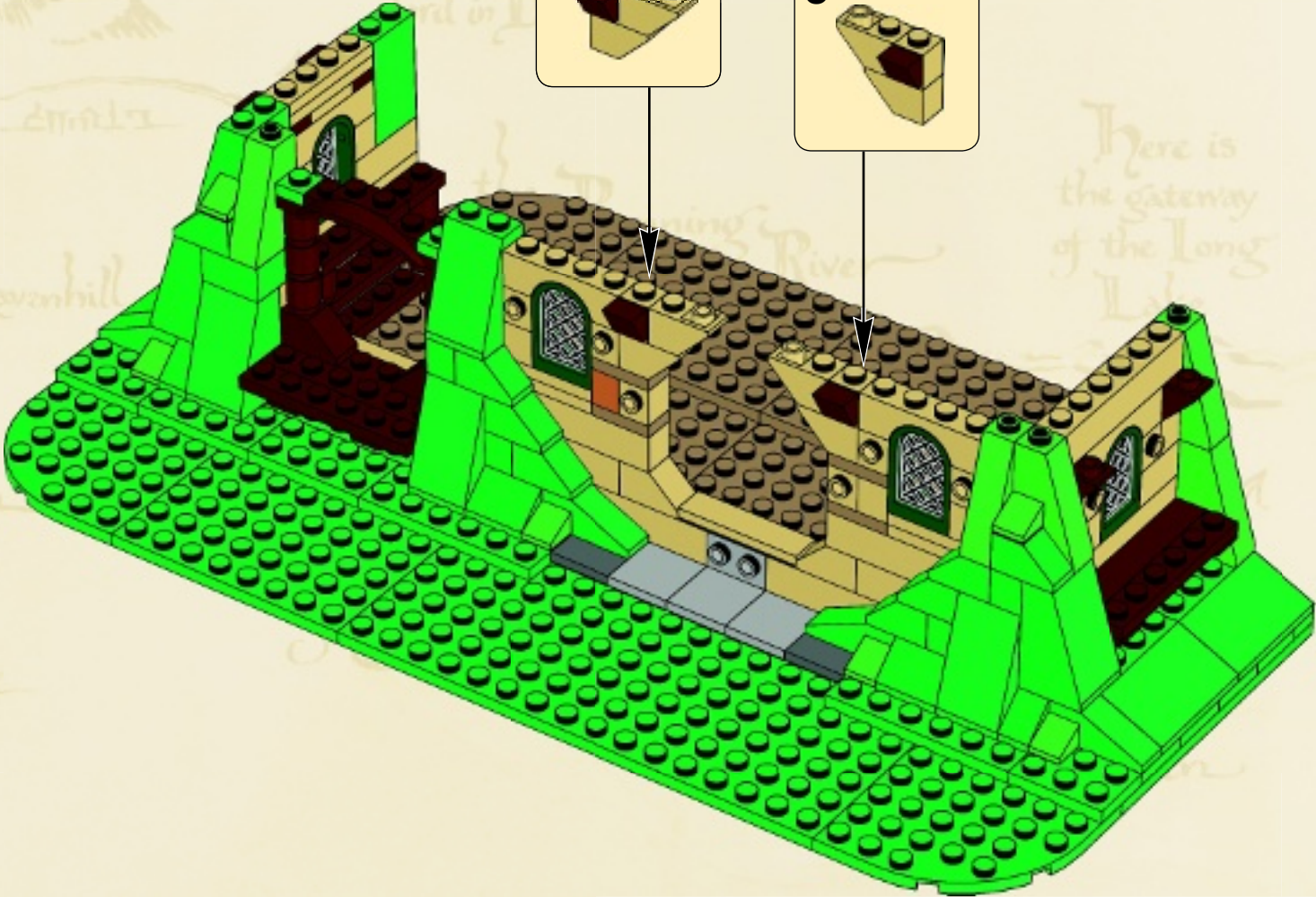

2x

59

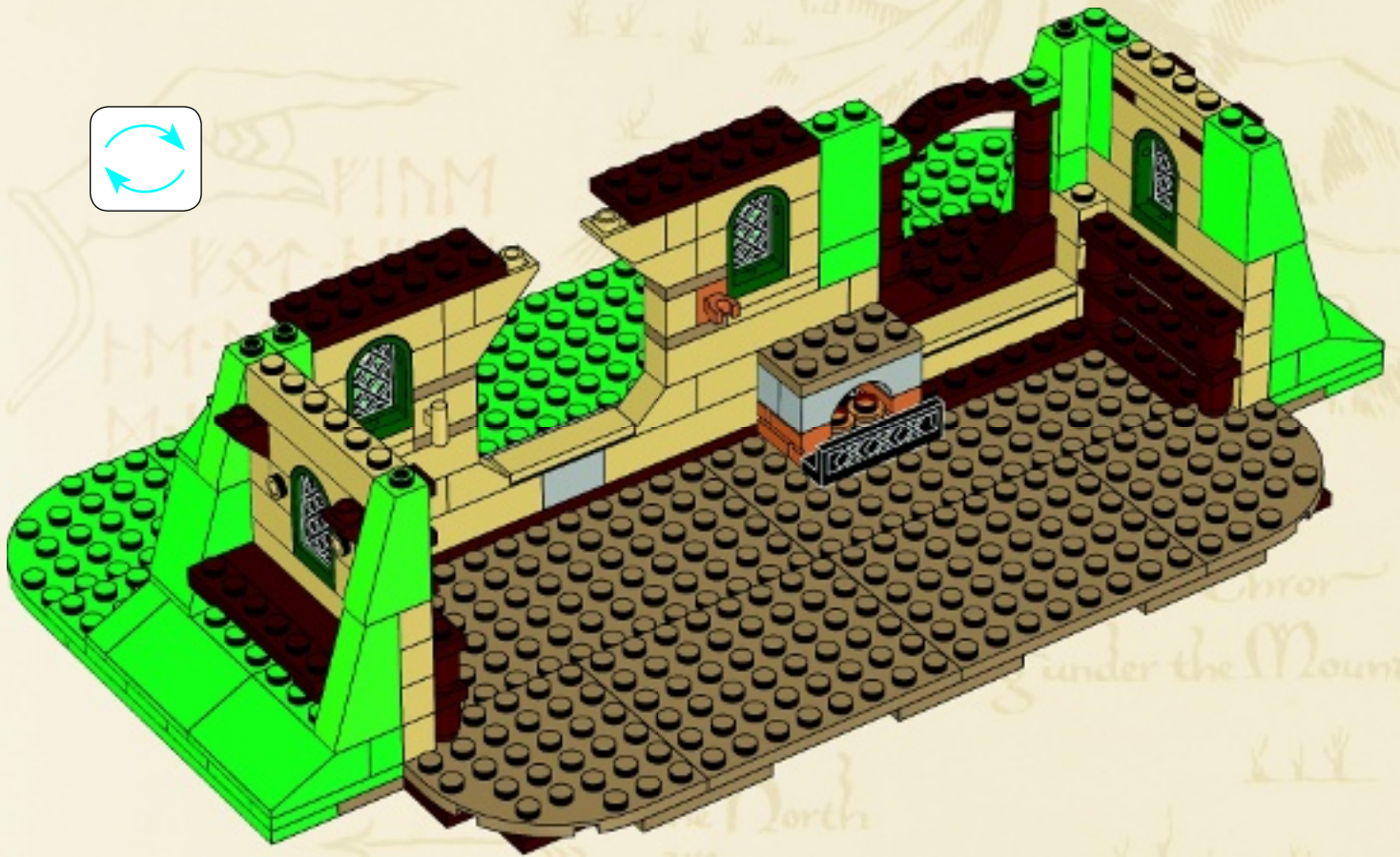



# 60

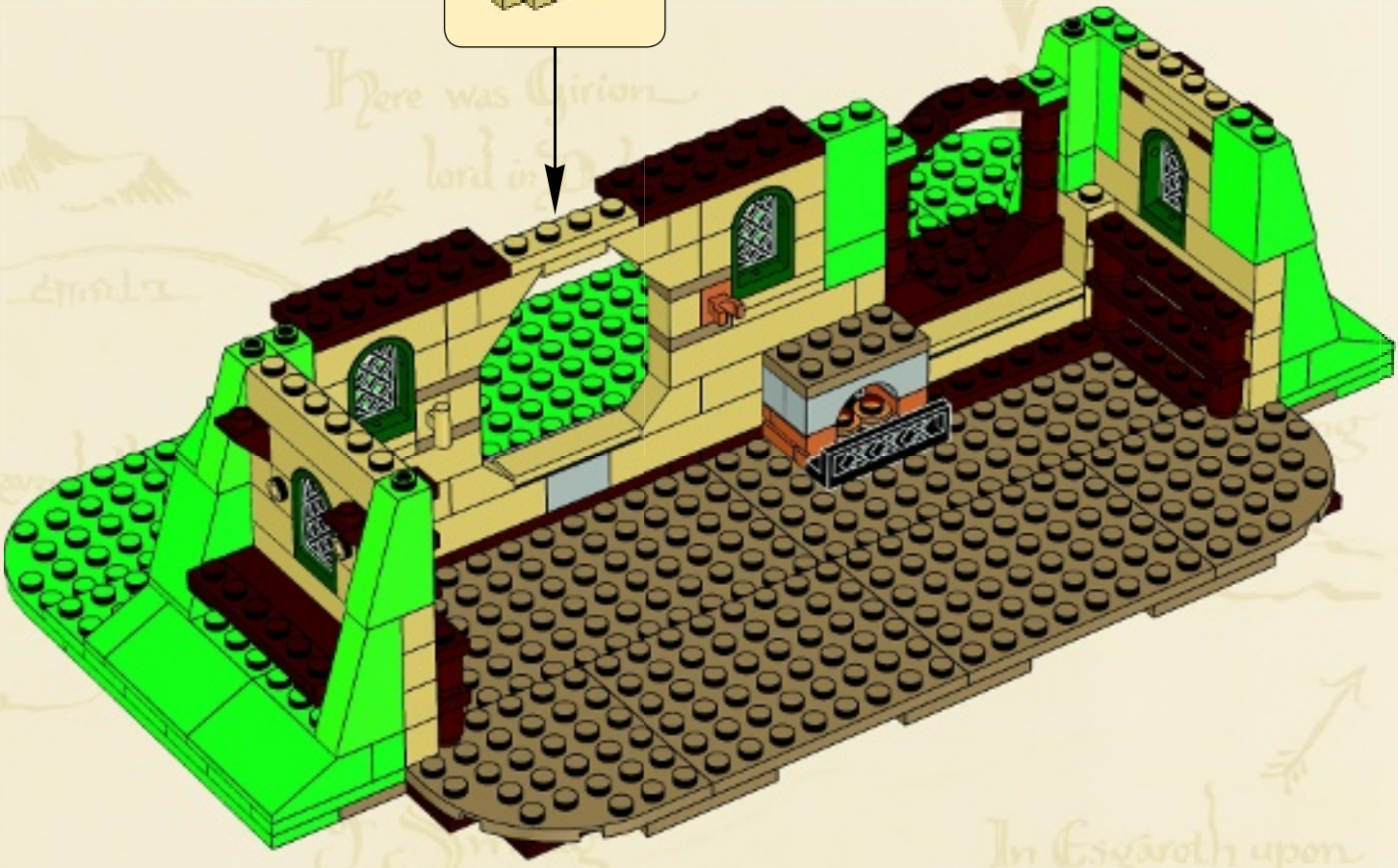
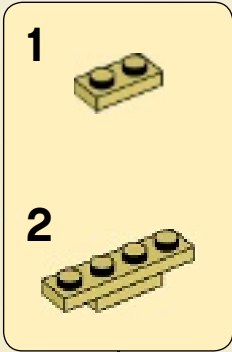

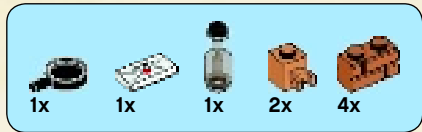

# 61

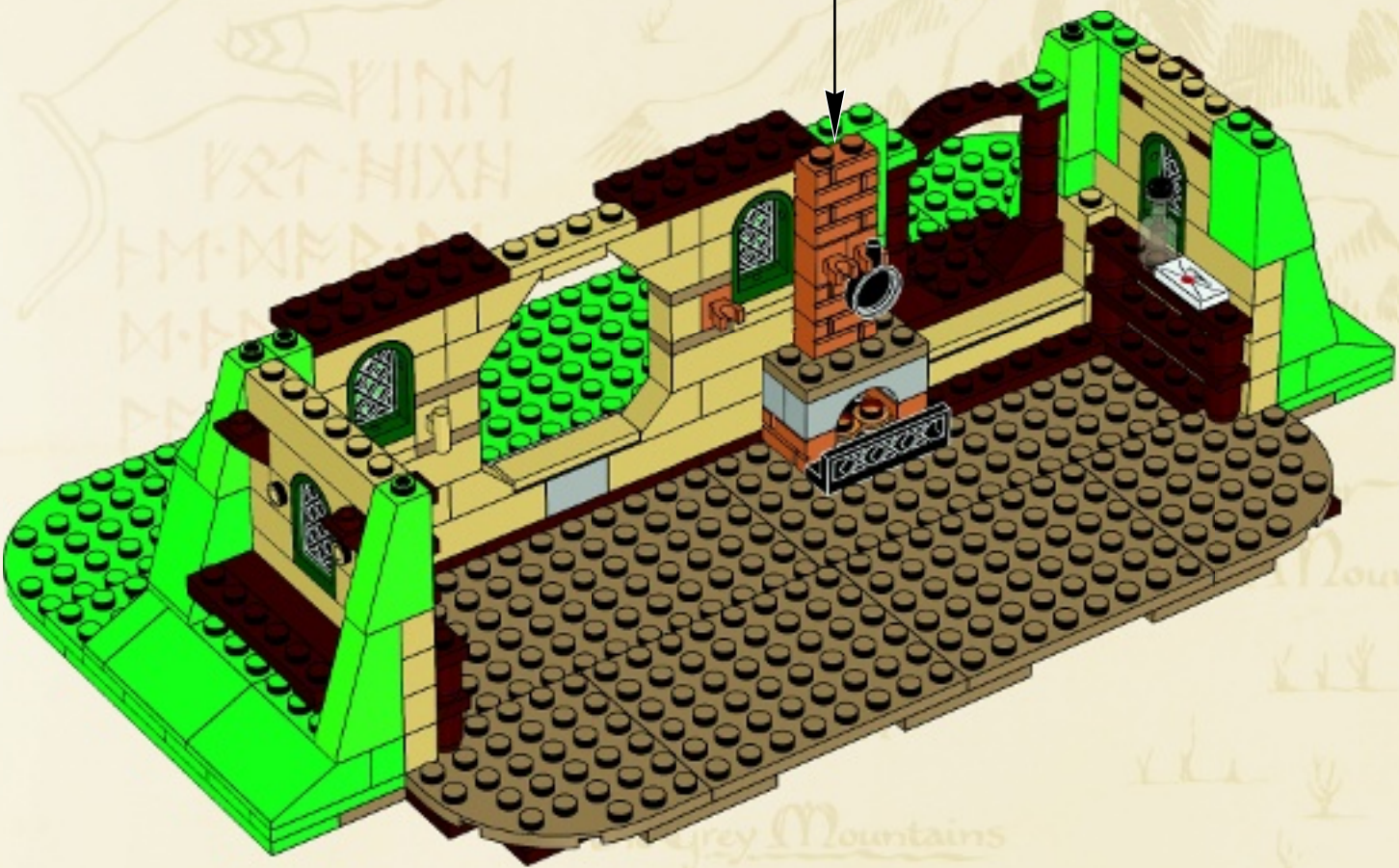
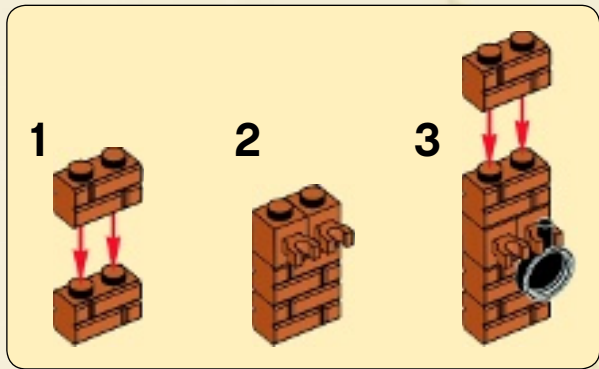



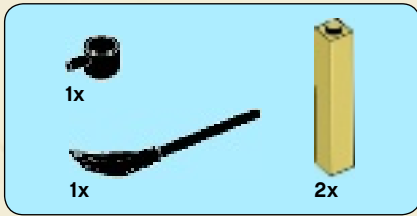

62

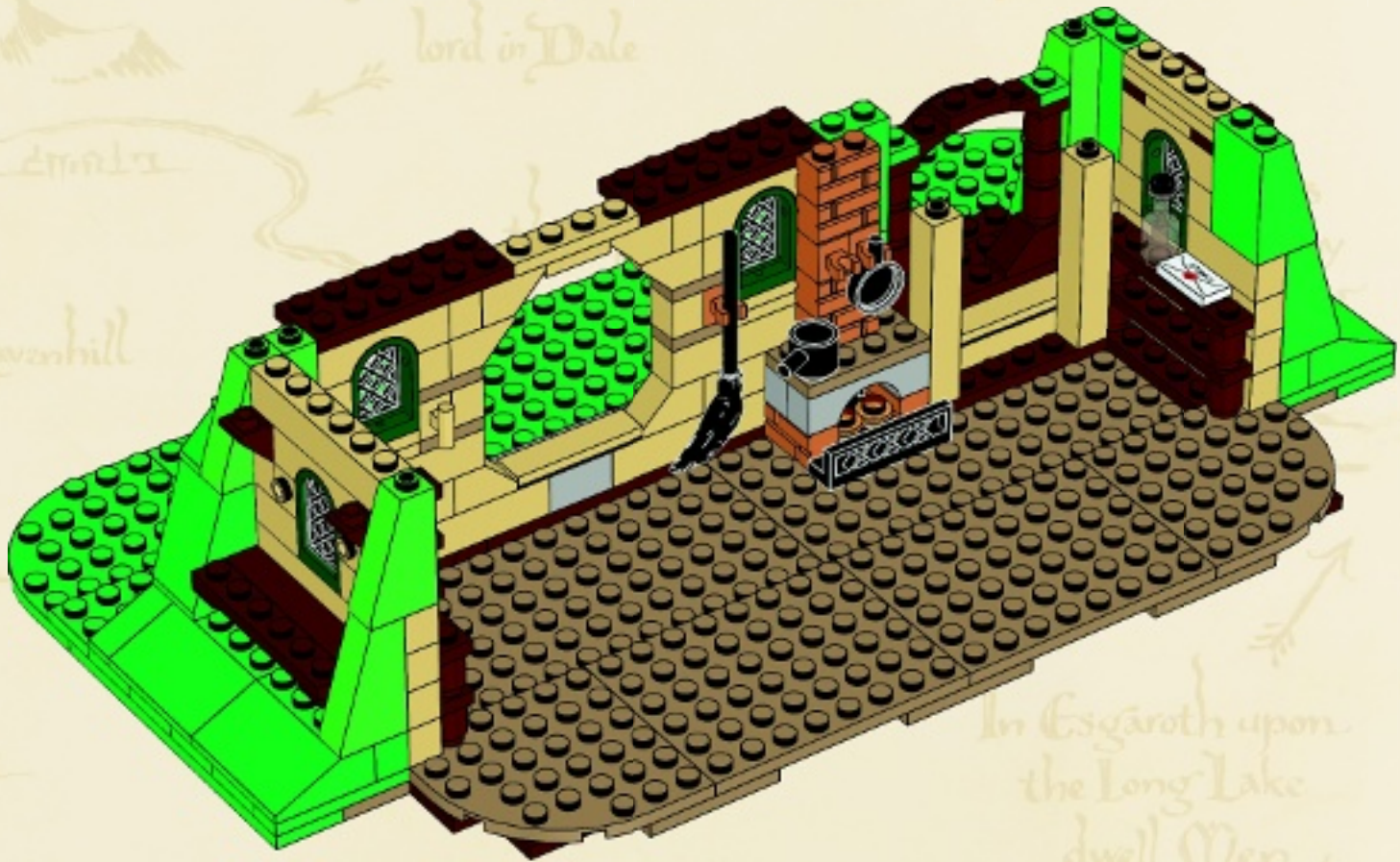

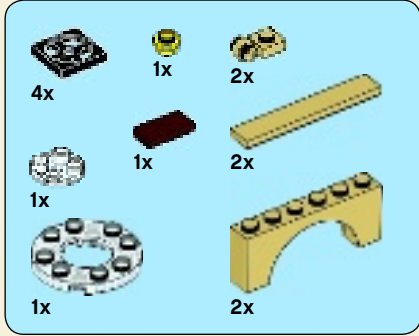

# 63

1



2



3

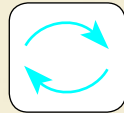

4



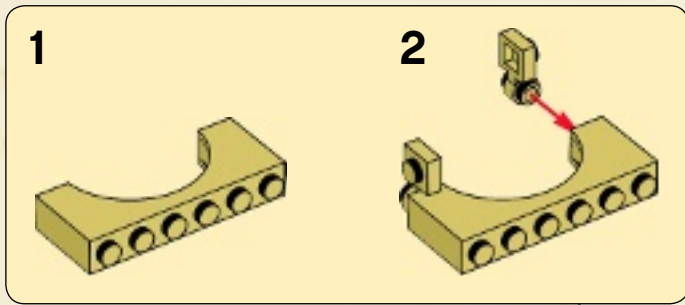

**5**

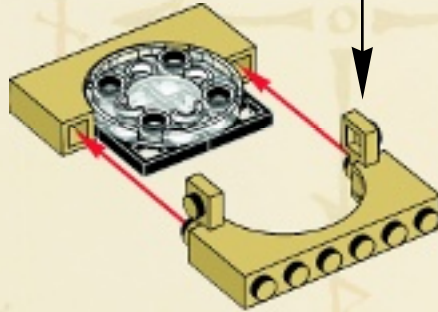

**6**



**7**

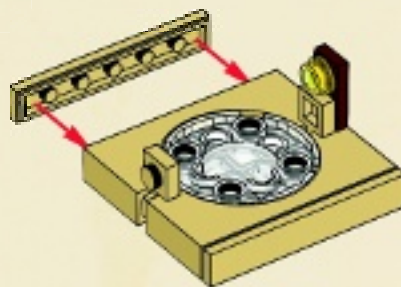

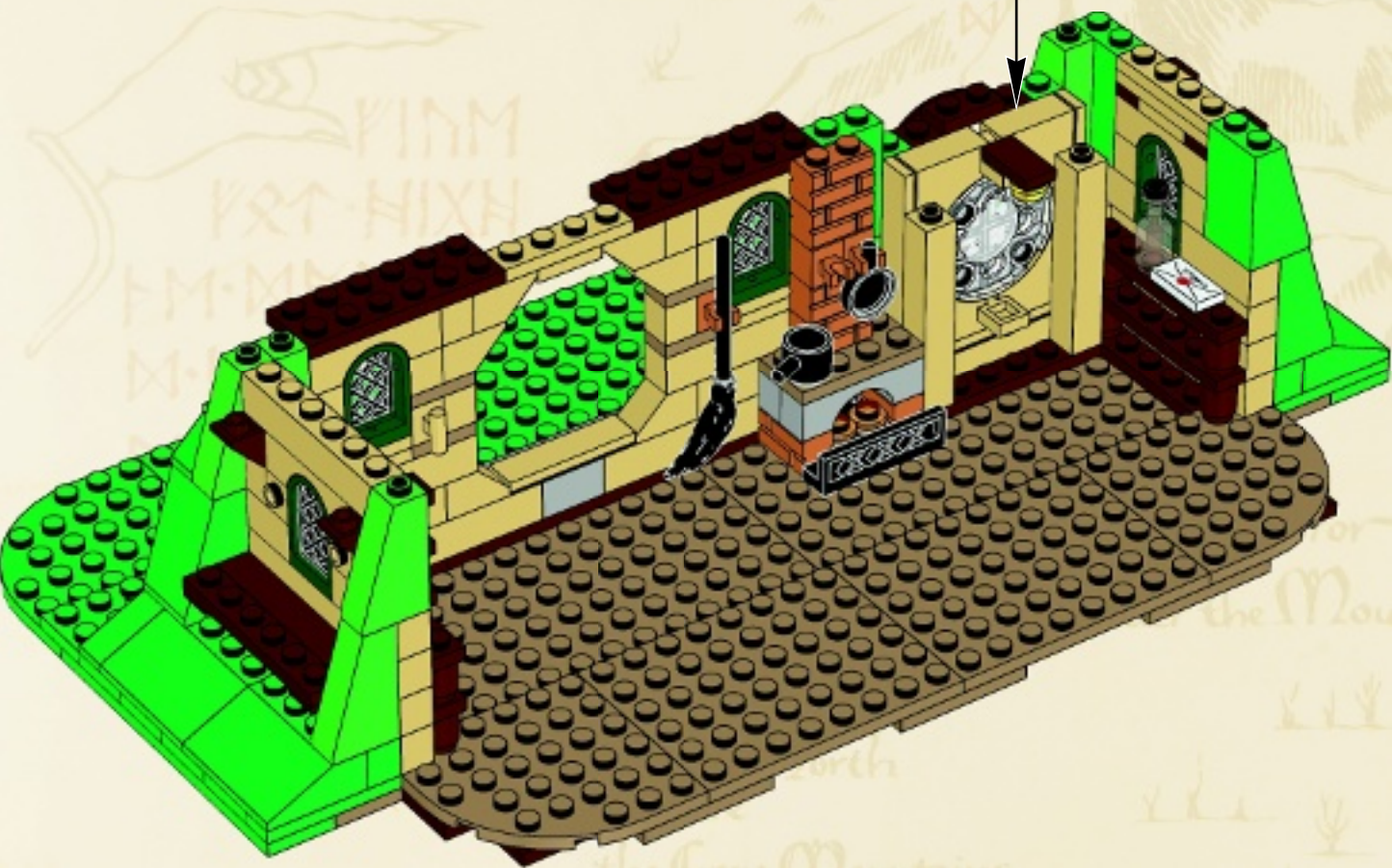
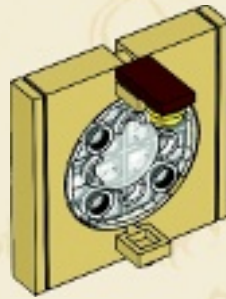
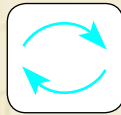



2x

64

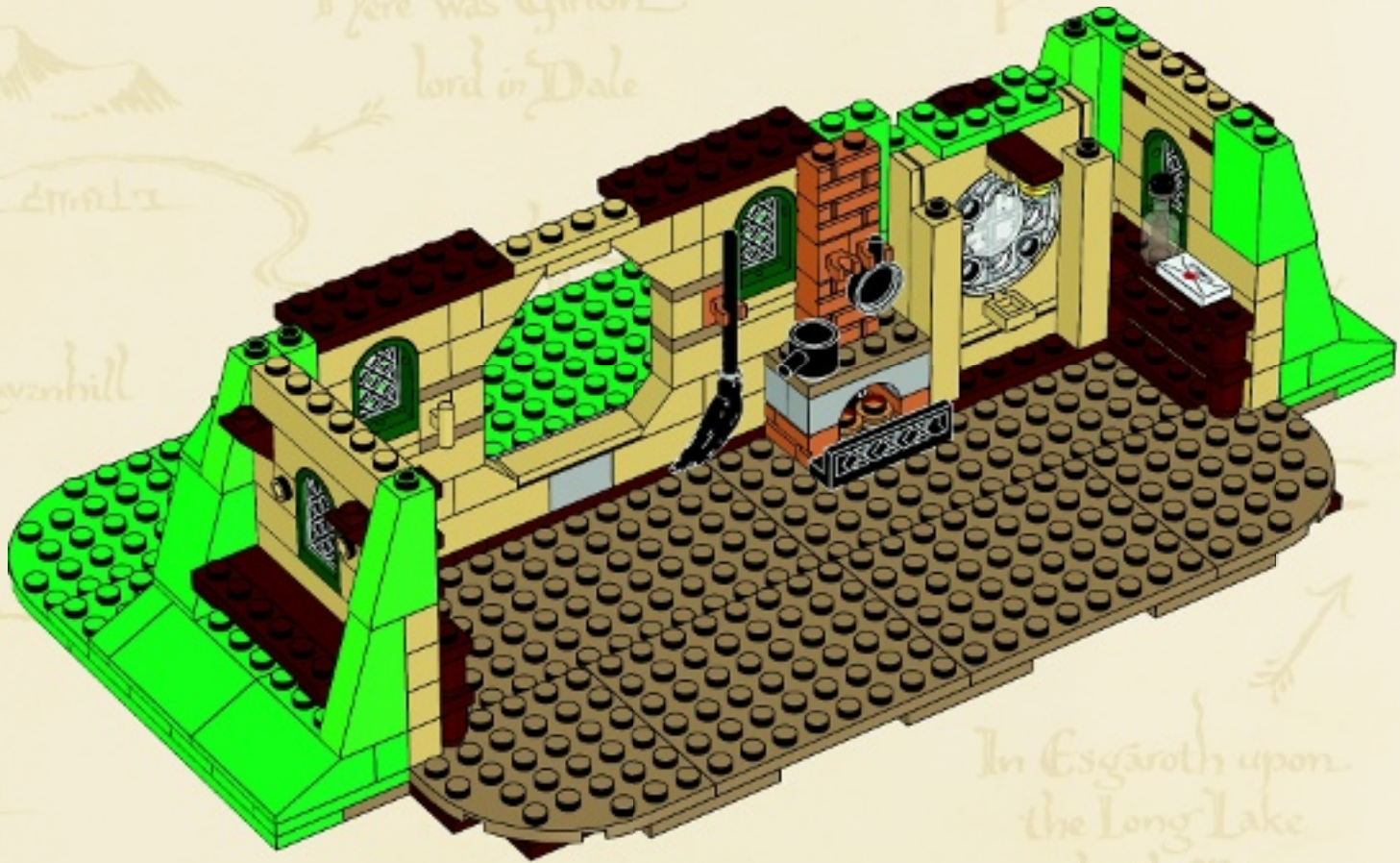

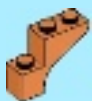

2x

65

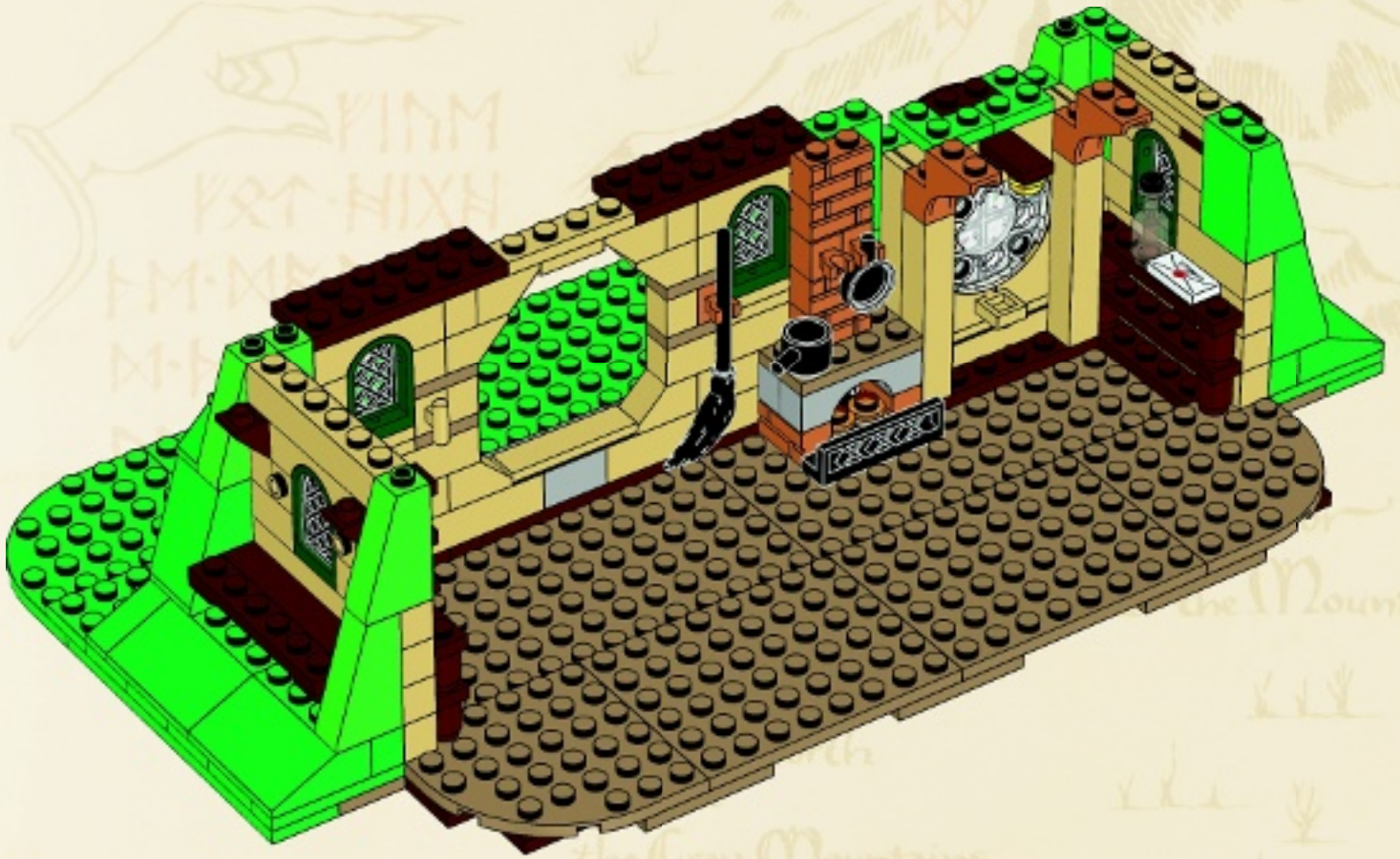

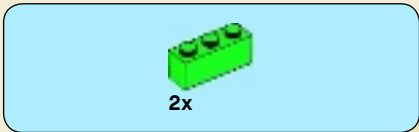

66

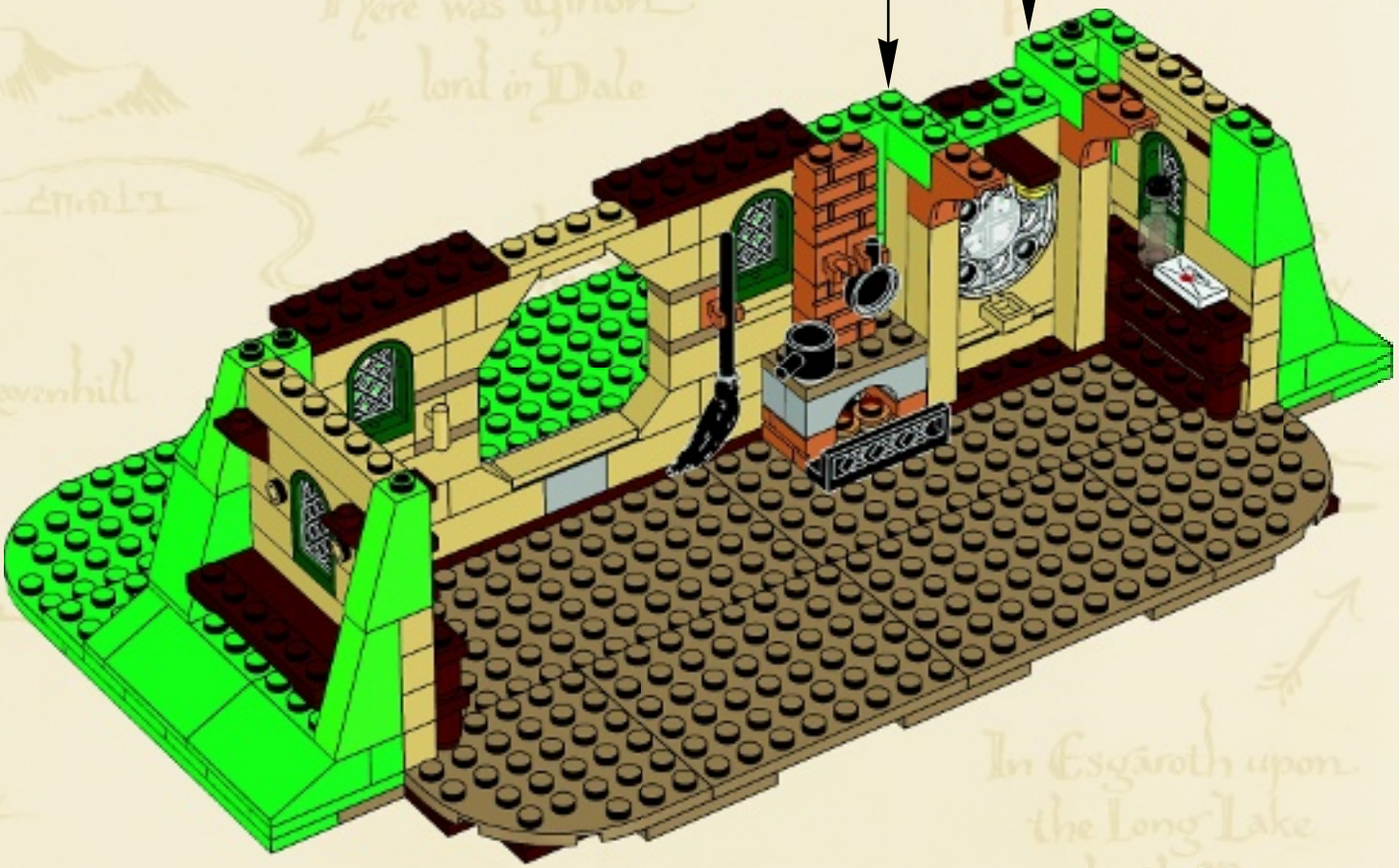
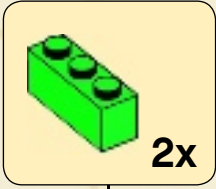



2x

67

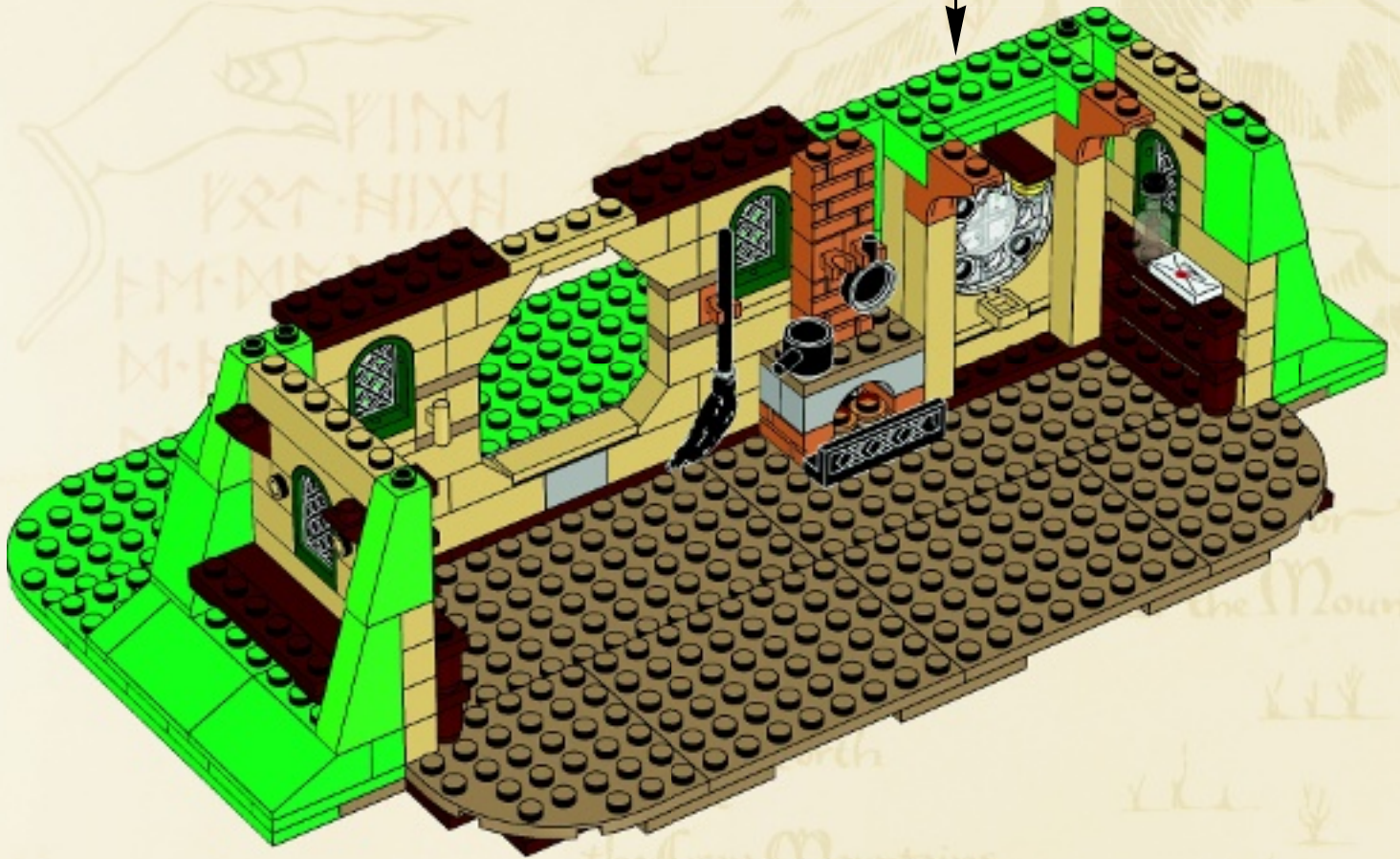
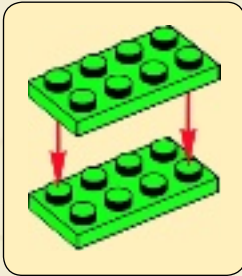



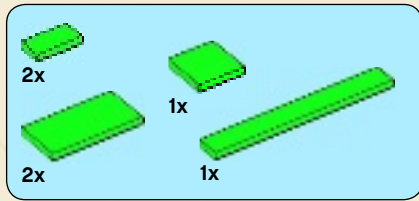

68

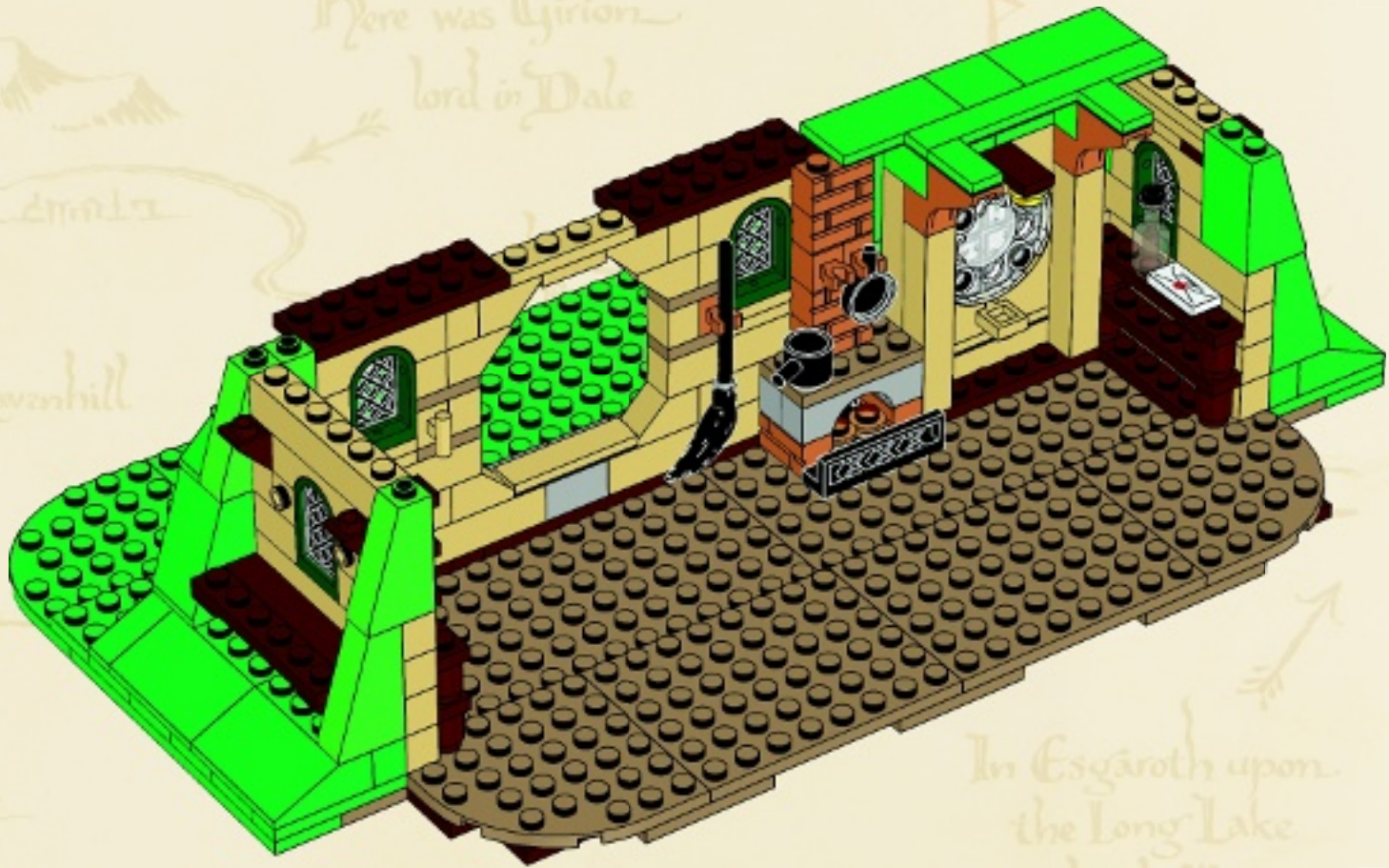



# 69

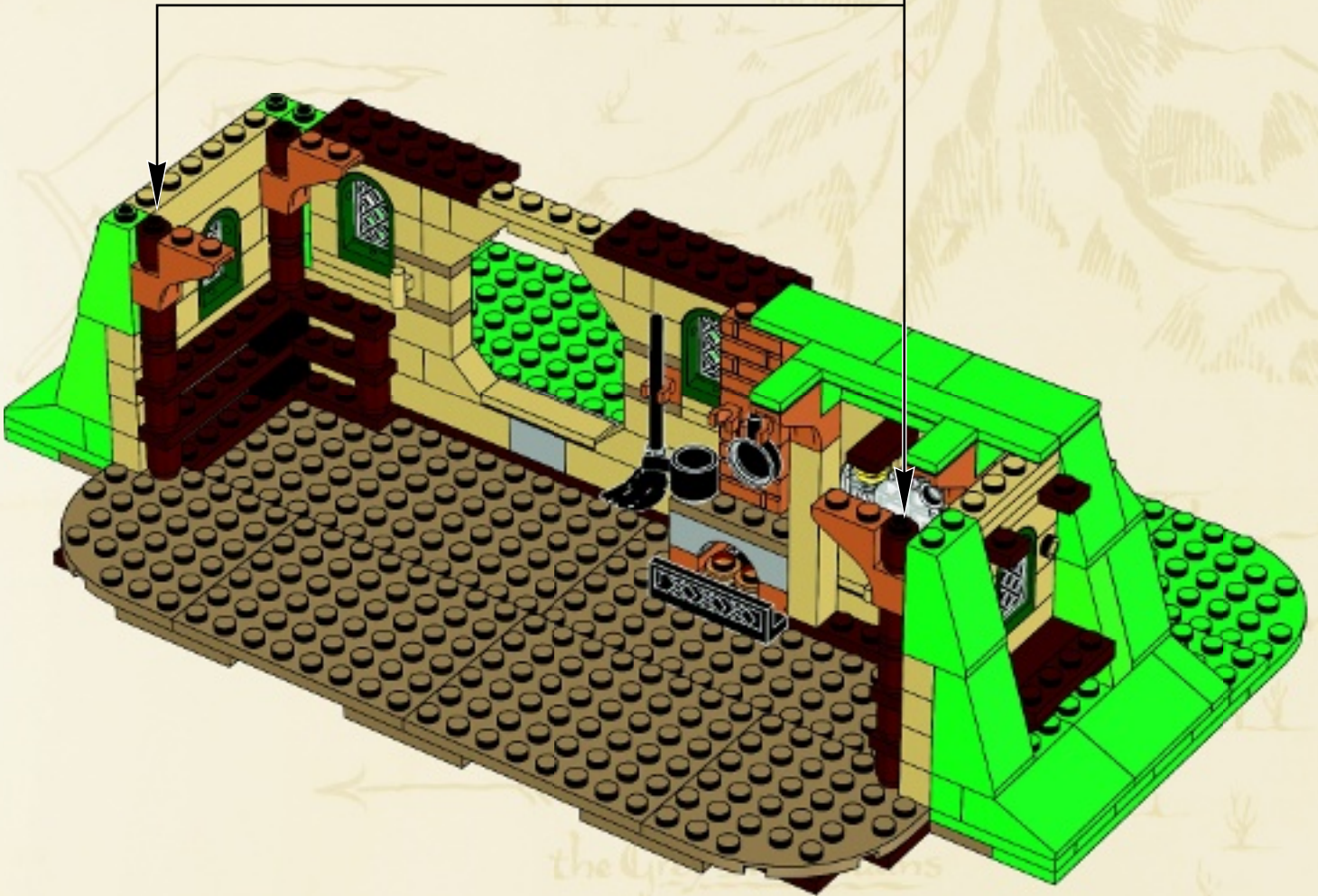
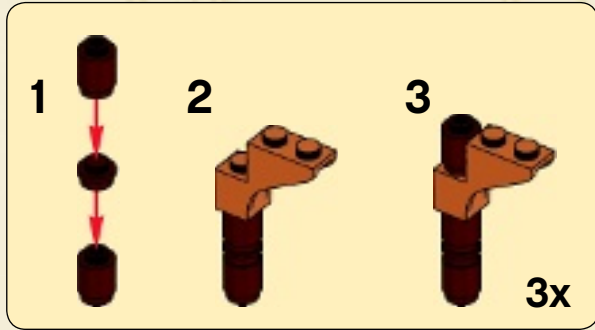

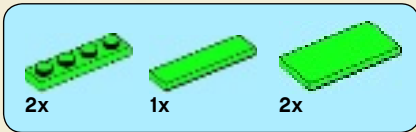

70

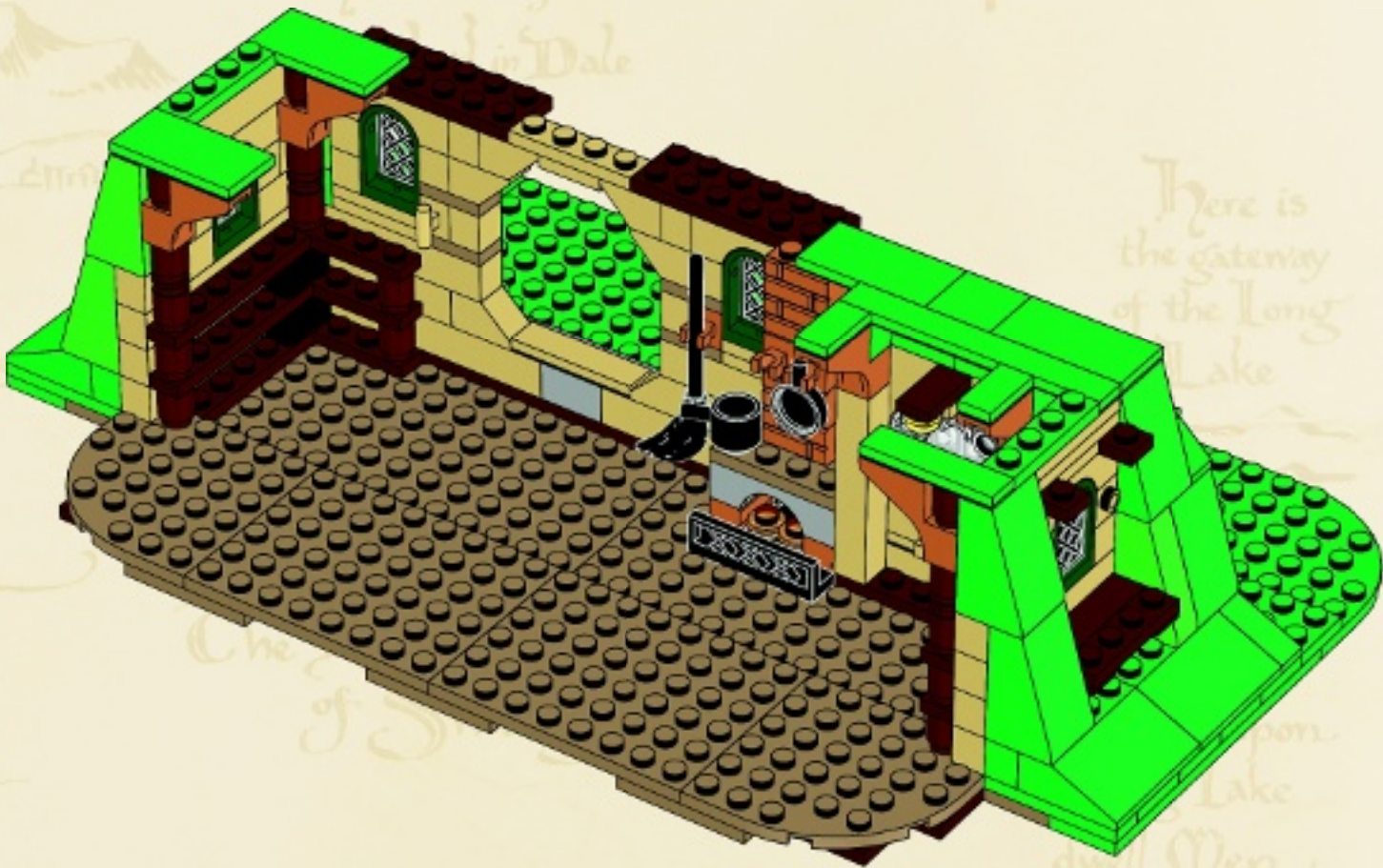

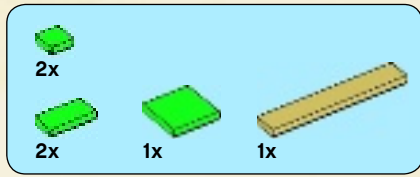

71

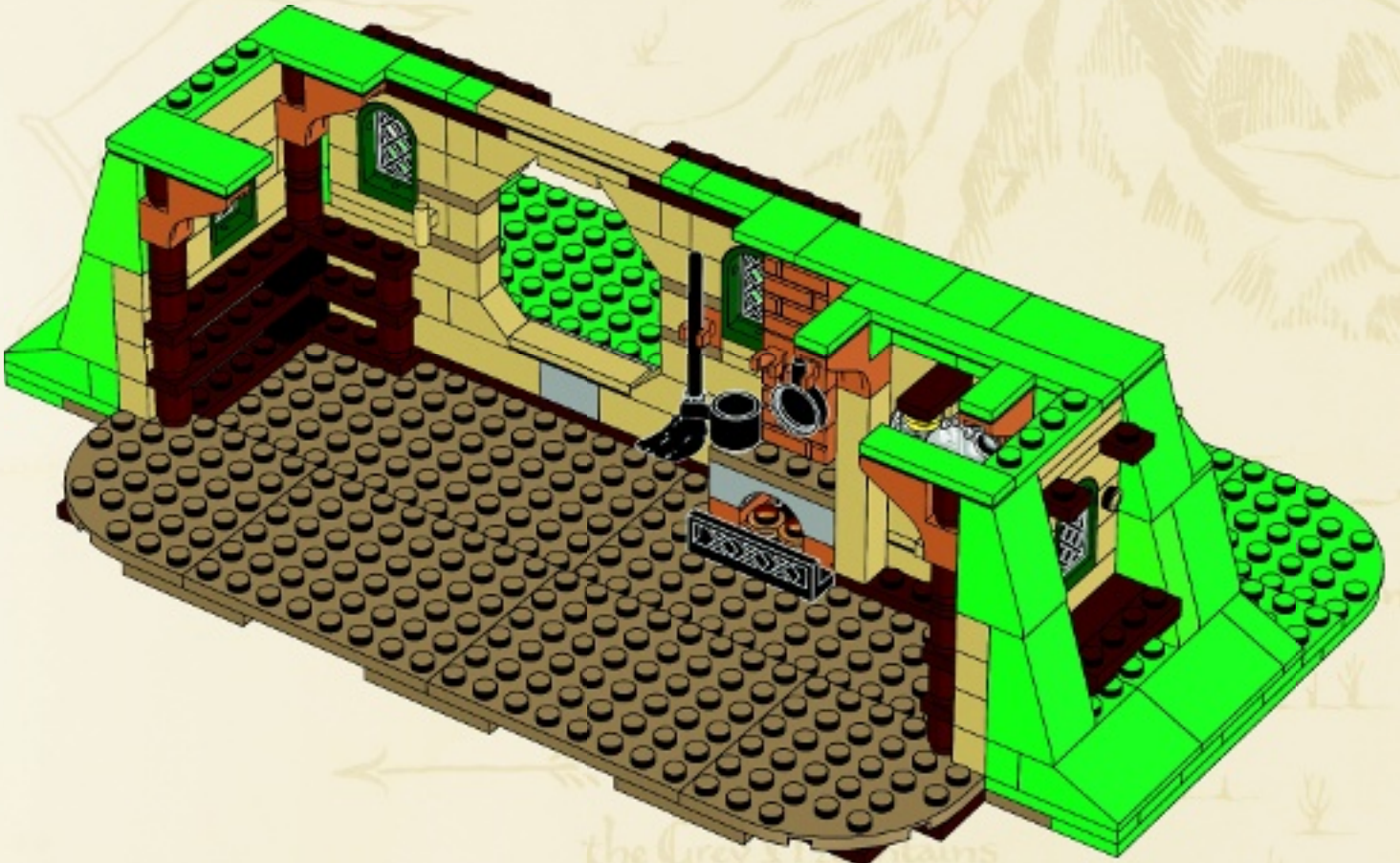

*the Grey's...  
&  
the Withered Heath  
whence come the*

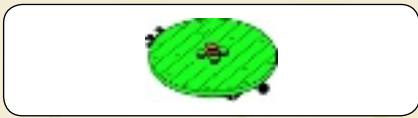

1

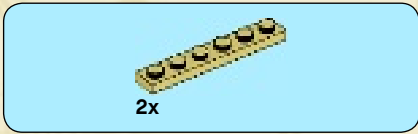
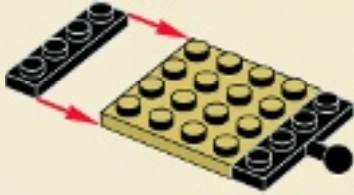

2



3

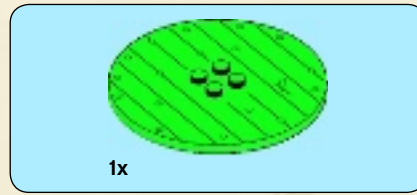
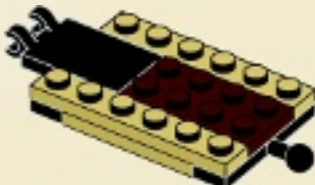

4

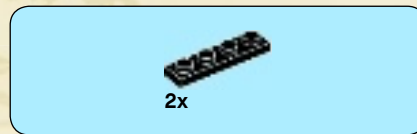
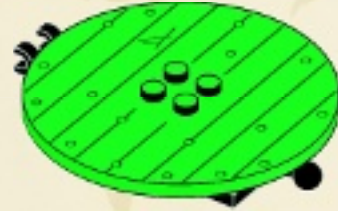

5

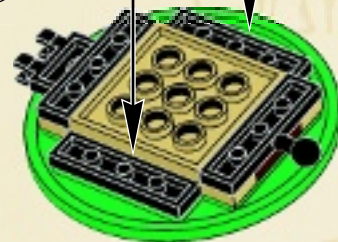
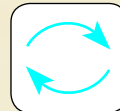
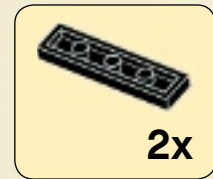





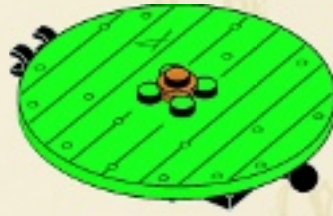
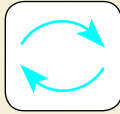

1x

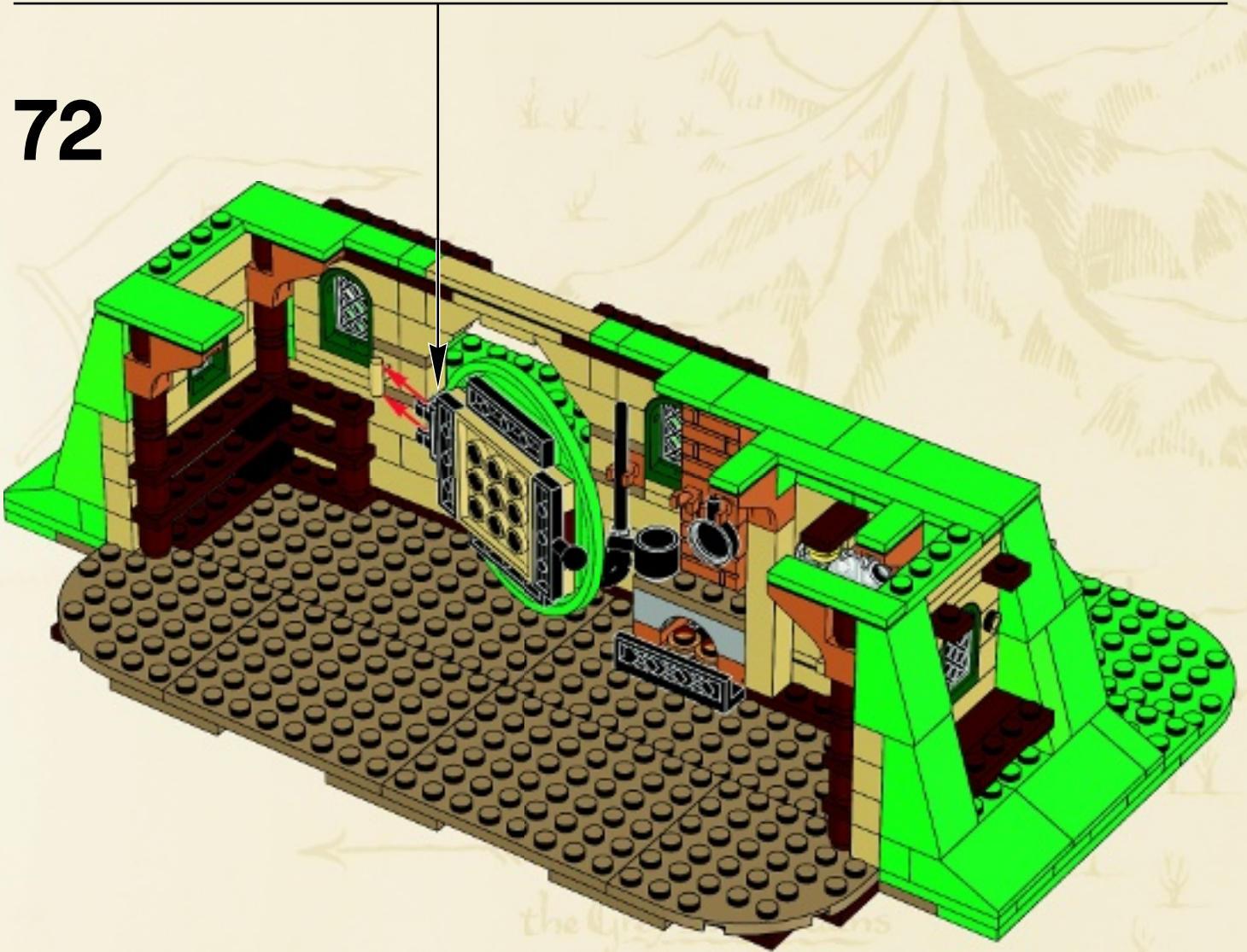
6



72



-   
1x
-   
2x
-   
1x
-   
1x
-   
1x

# 73

- 1 
- 2 

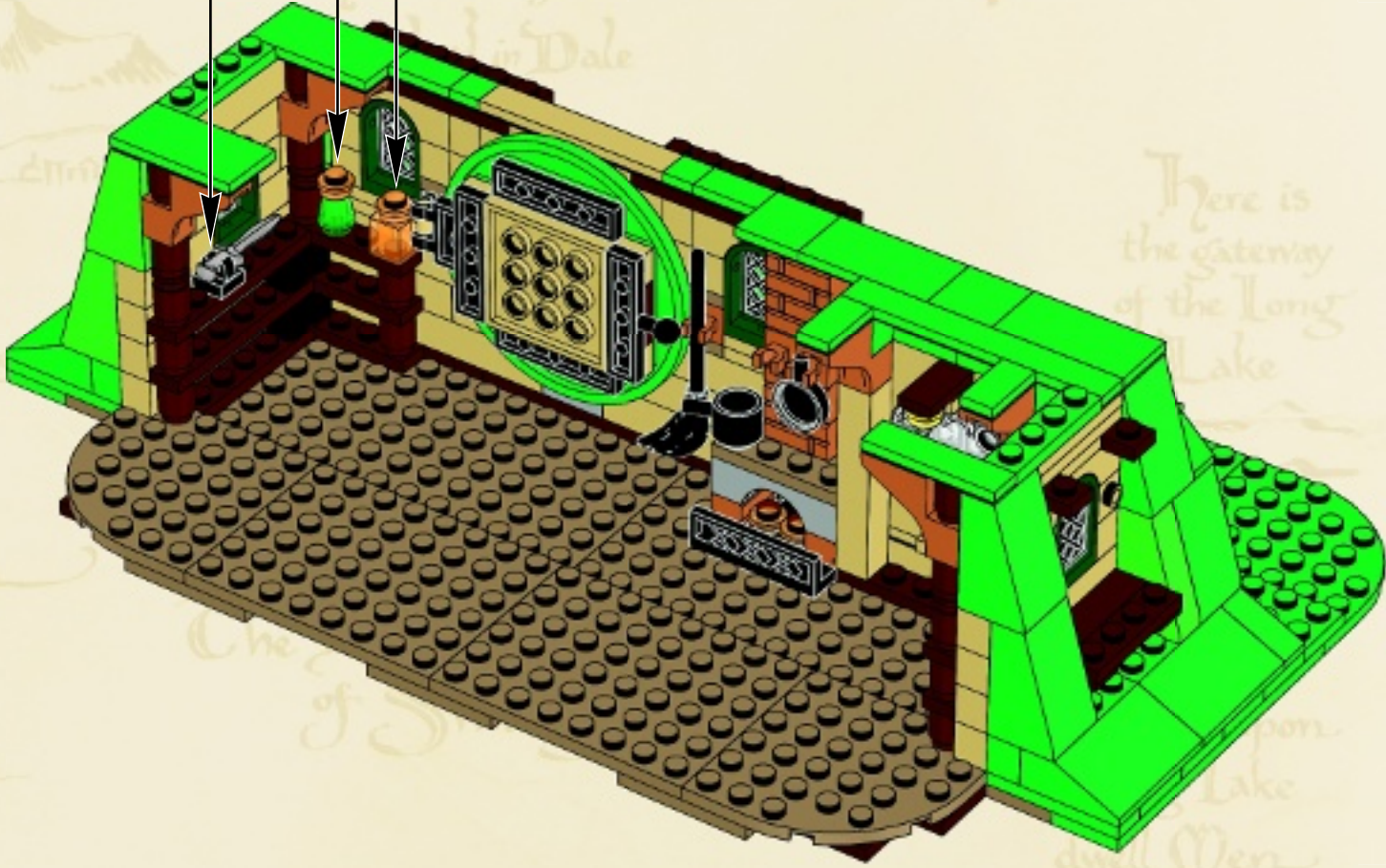

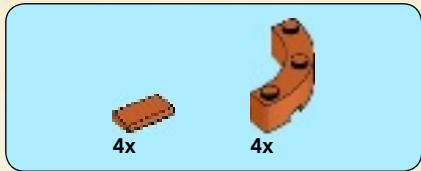

# 74

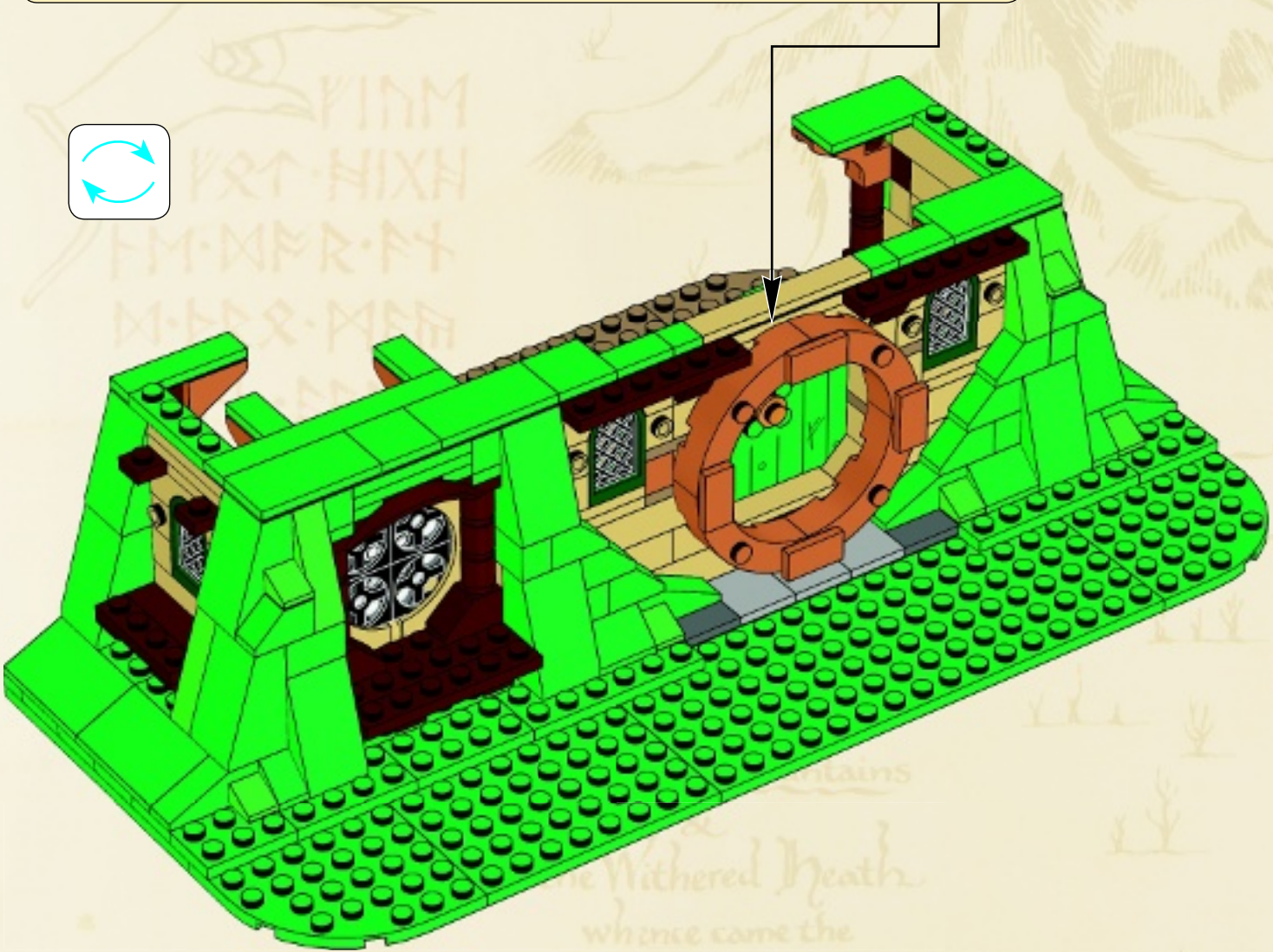
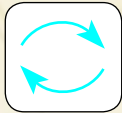
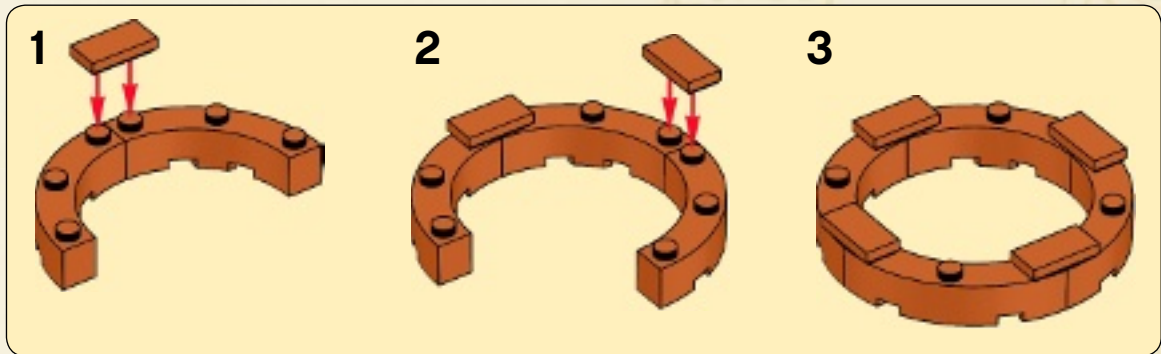





# 75

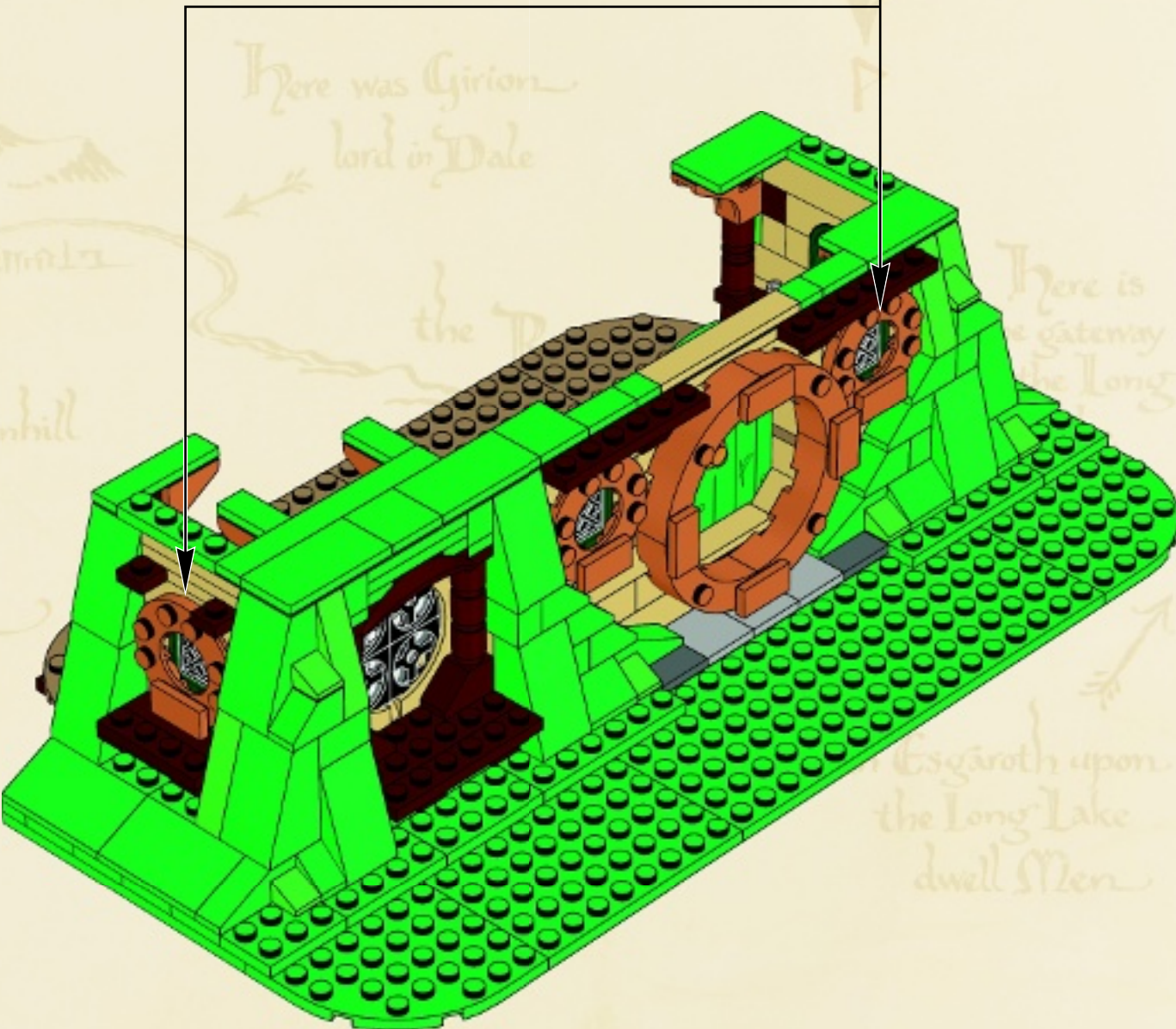

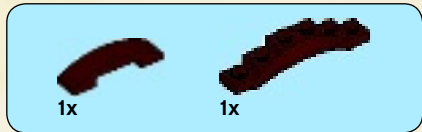

76

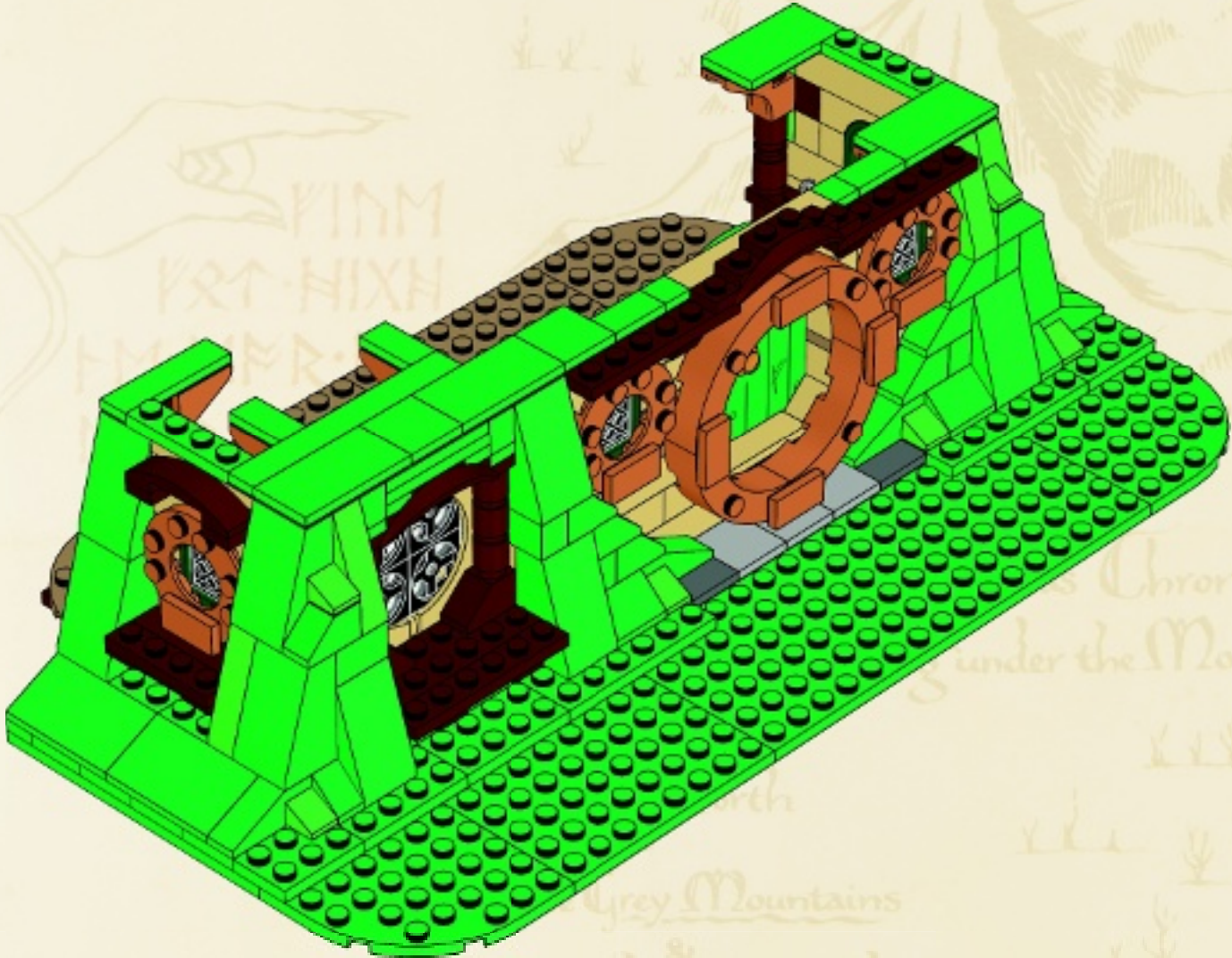

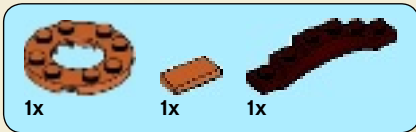

77

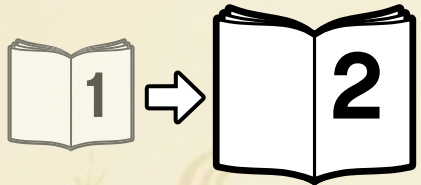
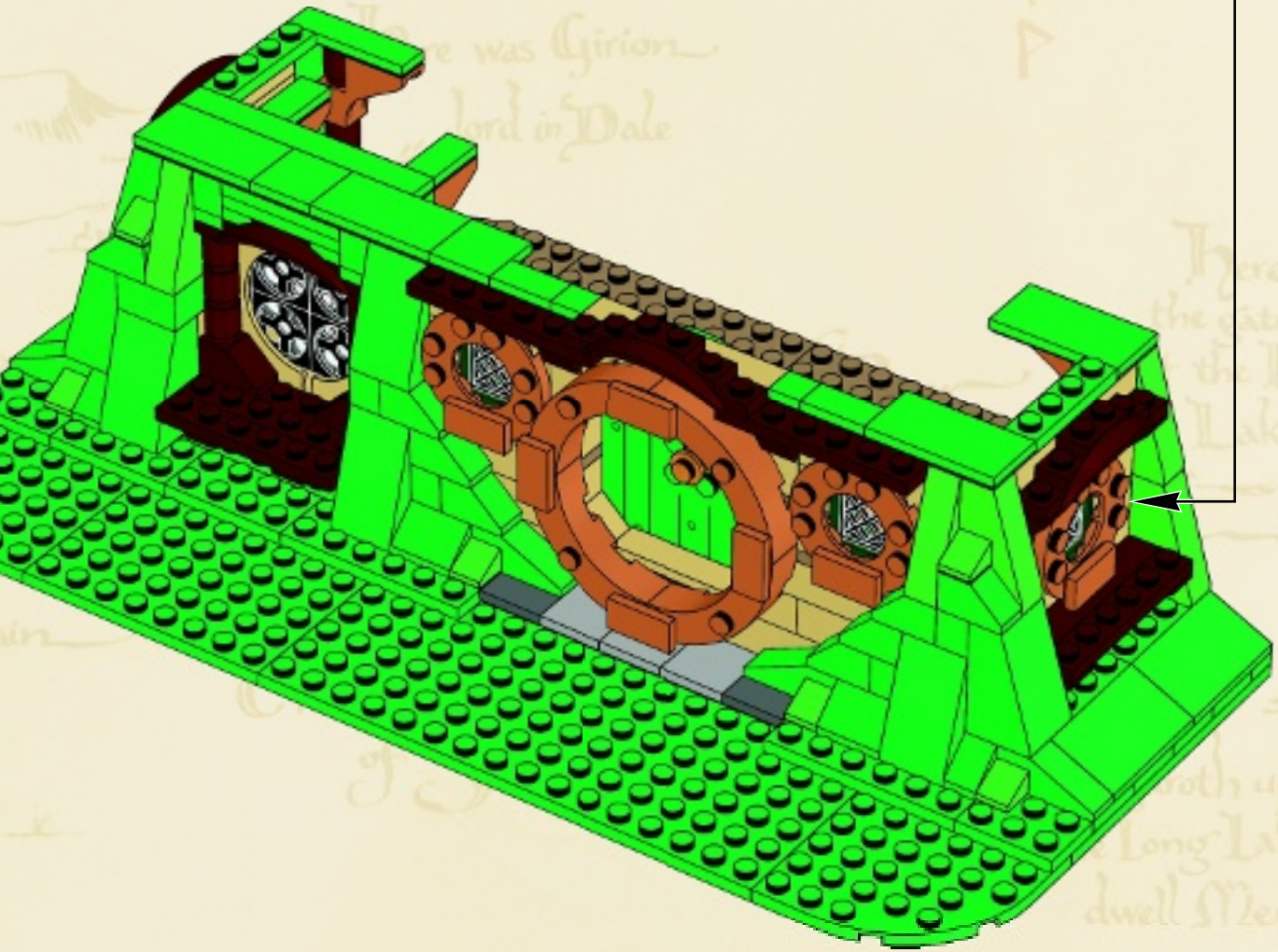



# WIN!

Go to [www.LEGOsurvey.com/product](http://www.LEGOsurvey.com/product) to fill out a survey for a chance to win a cool LEGO® Product.

No purchase necessary.

Open to all residents where not prohibited.



## [www.LEGOsurvey.com/product](http://www.LEGOsurvey.com/product)

### GEWINNE!

Nimm an der Umfrage auf [www.LEGOsurvey.com/product](http://www.LEGOsurvey.com/product) teil und hab die Chance ein cooles LEGO® Produkt zu gewinnen!

Die Teilnahme am Gewinnspiel führt zu keinerlei Kaufverpflichtungen. Teilnahme in allen nicht ausgeschlossenen Ländern möglich.

### WIN!

Ga naar [www.LEGOsurvey.com/product](http://www.LEGOsurvey.com/product), vul een enquêteformulier in en maak kans op een cool LEGO® product.

Geen aankoopverplichting. Iedereen mag deelnemen, uitgezonderd ingezetenden van landen waar een enquêteverbod geldt.

### GAGNE!

Visite [www.LEGOsurvey.com/product](http://www.LEGOsurvey.com/product) pour répondre à un questionnaire et avoir une chance de gagner un produit LEGO® très cool!

Aucune obligation d'achat. Ouvert à tous les résidents des pays autorisés.

### 当てよう!

[www.LEGOsurvey.com/product](http://www.LEGOsurvey.com/product) にアクセスして、アンケートにご記入ください。当選者にはレゴ製品を差し上げます。

お買い上げの必要はありません。禁止されていない限り、すべての皆様にご利用いただけます。



LEGO.com

LEGO and the LEGO logo are trademarks of the/sonnt des marques de commerce de/son marcas registradas de LEGO Group.  
©2012 The LEGO Group. 6036617

THE HOBBIT: AN UNEXPECTED JOURNEY: © NLP™ Middle-earth Ent. Lic. to New Line. (s12)  
LE HOBBIT : UN VOYAGE INATTENDU : © NLP™ Middle-earth Ent. Lic. à New Line. (s12)  
EL HOBBIT: UN VIAJE INESPERADO: © NLP™ Middle-earth Ent.; uso autorizado a New Line. (s12)