



Friends



3185



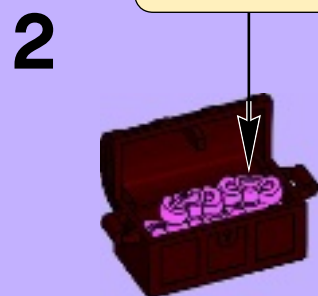
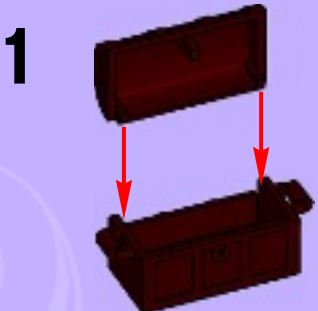
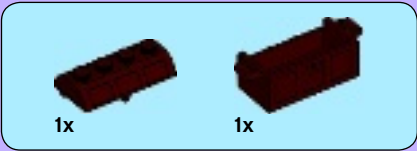
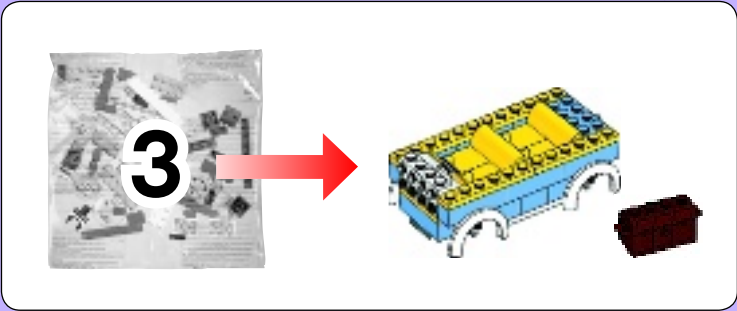
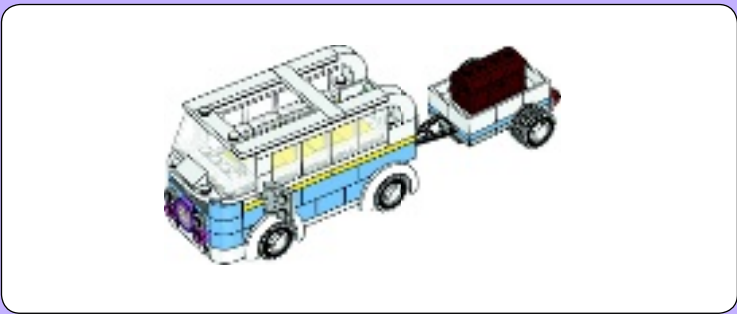

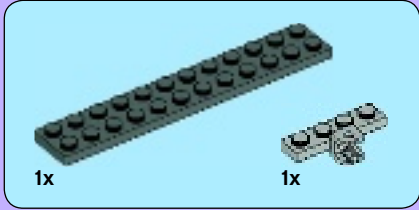
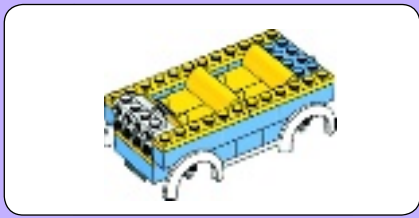

1

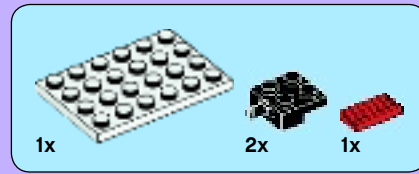
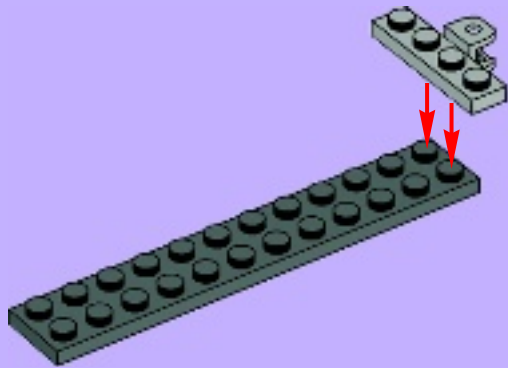

2





3

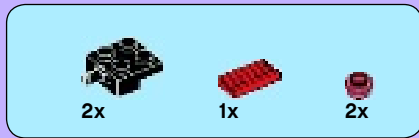

4

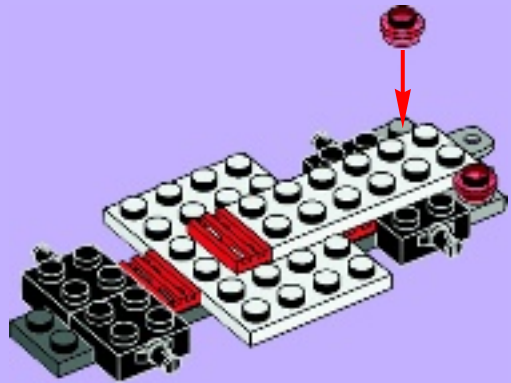



5

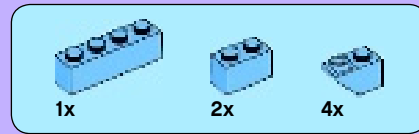

6

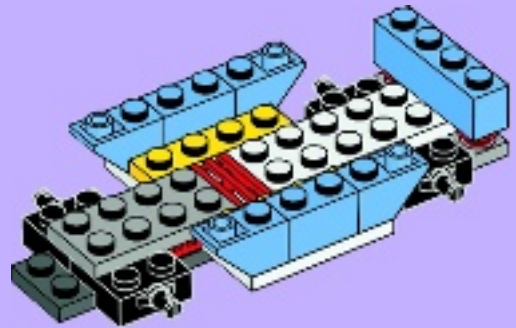



4x

7

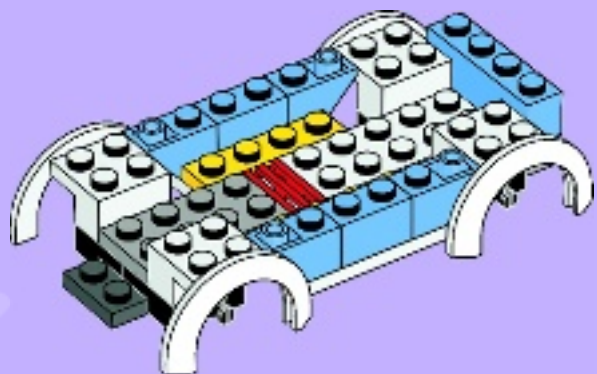

1x

8

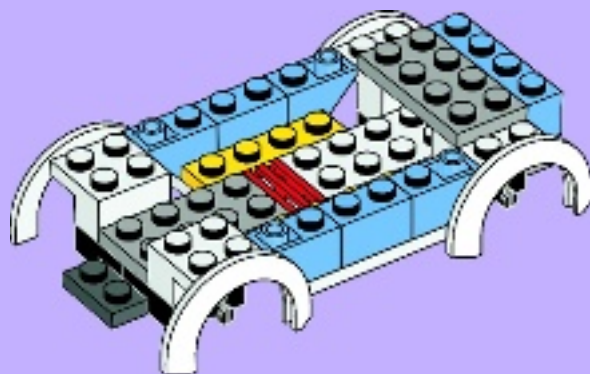

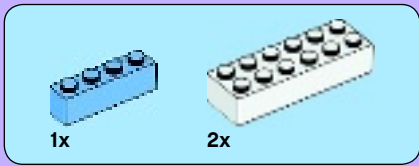

9

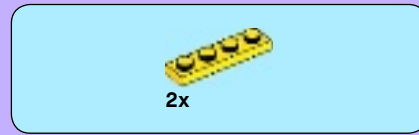
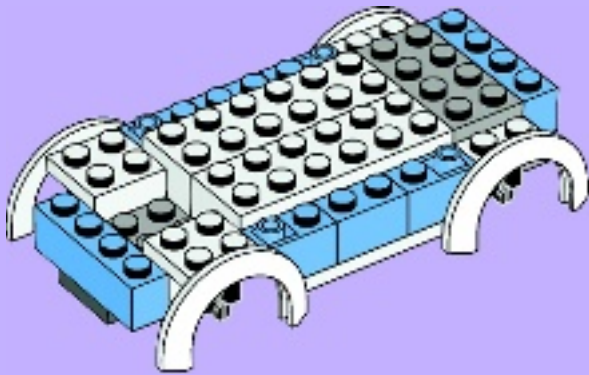

10

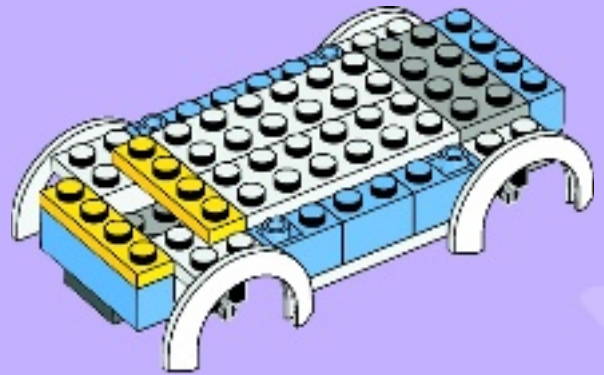



2x

11

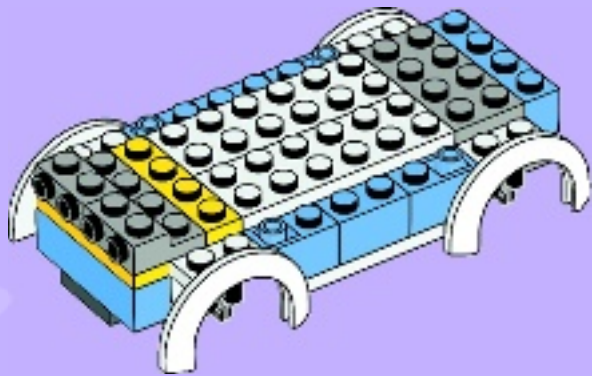

1x



2x

12

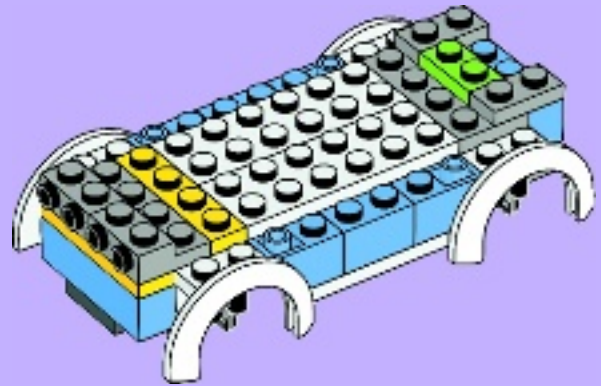



13

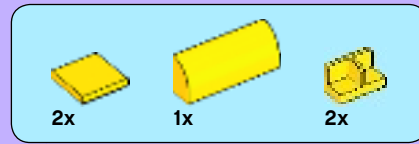
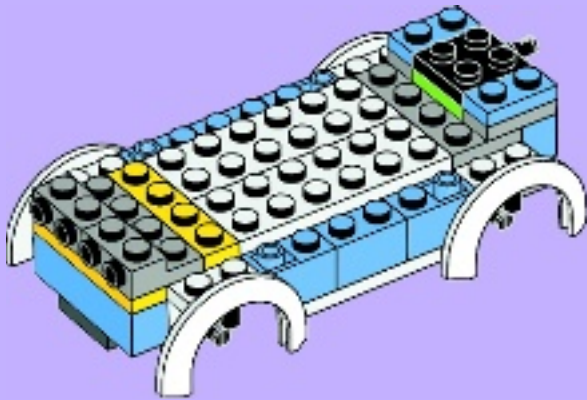

14

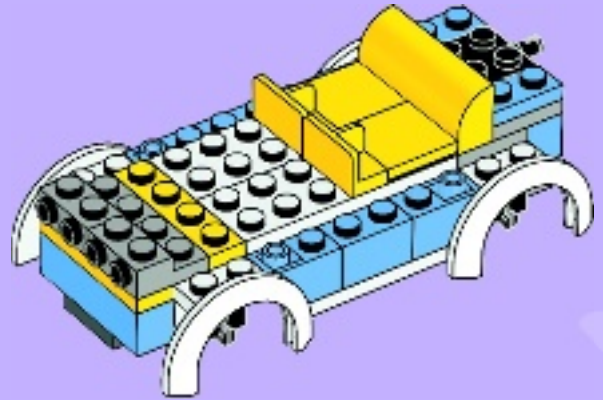

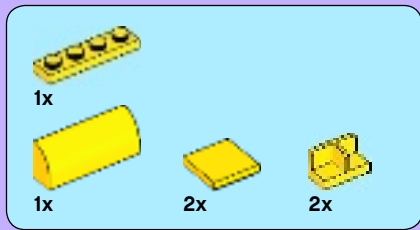

15

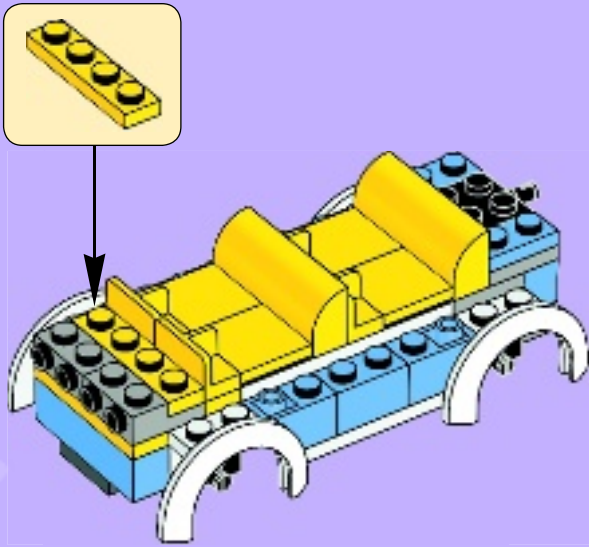

16

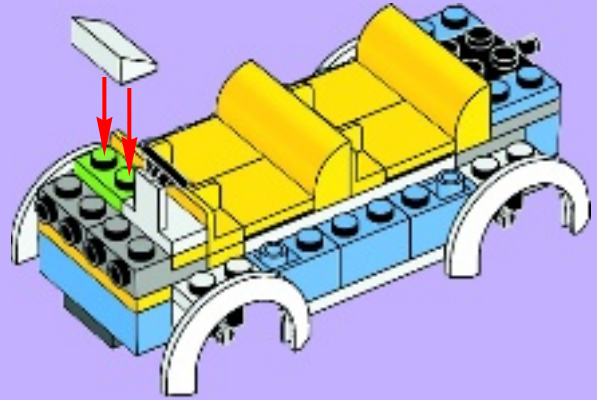

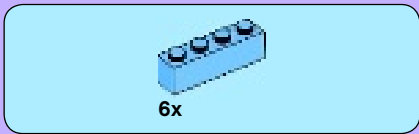

17

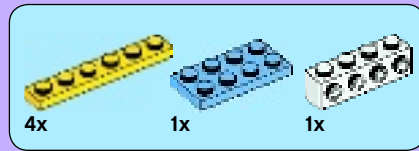
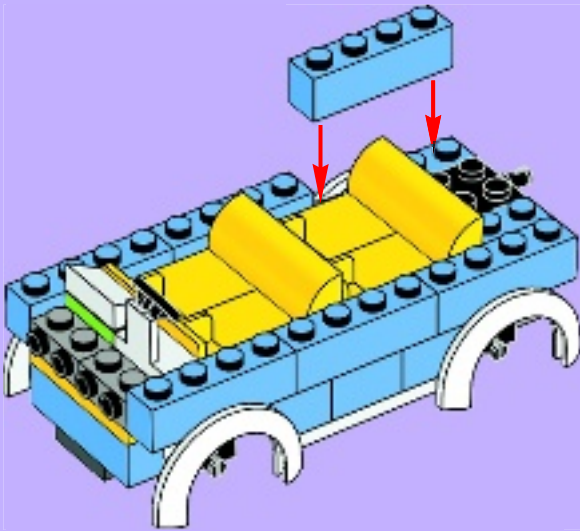

18

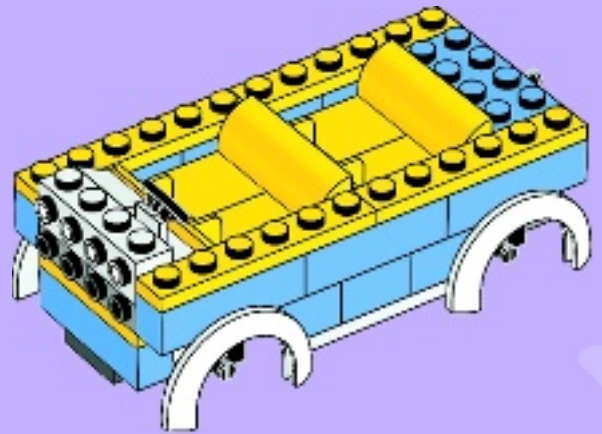



1x

19

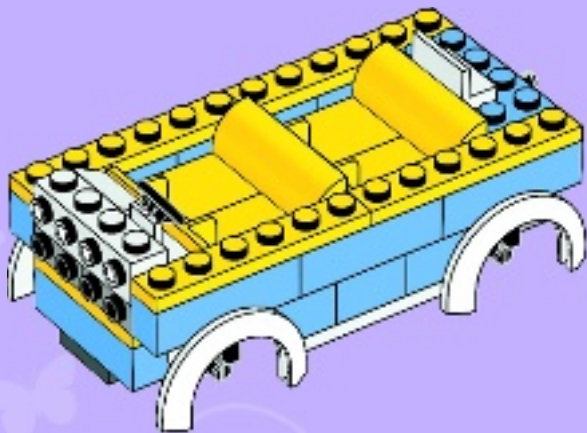

2x

20

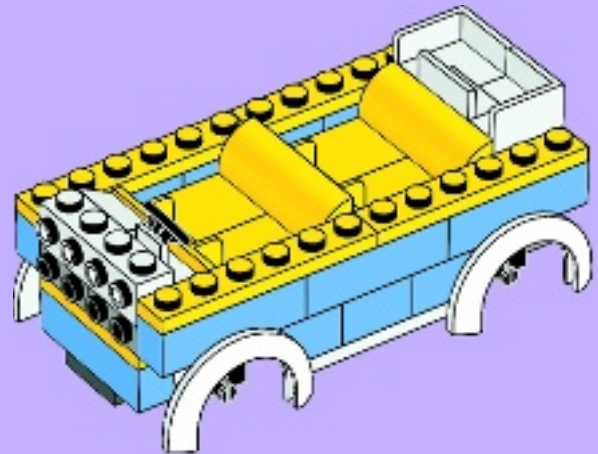

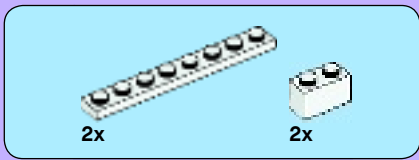

21

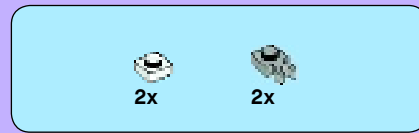
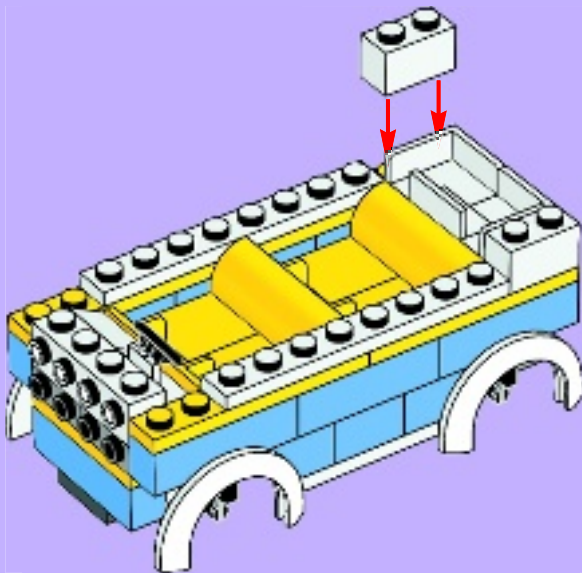

22

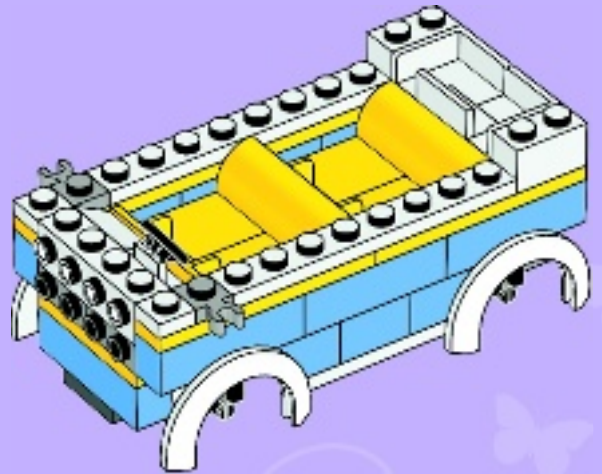



1x

1



2x

2



1x

3



2x



6x

4

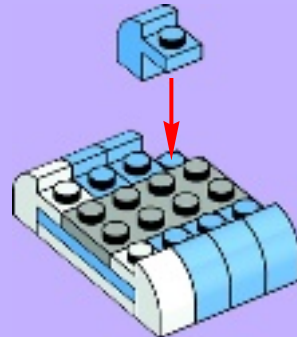



5

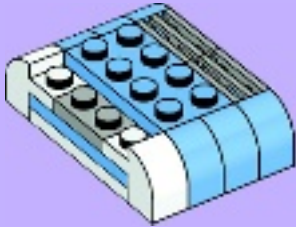

6

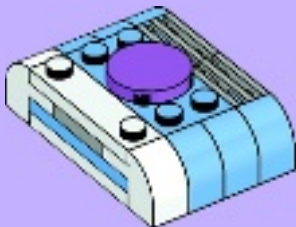

7

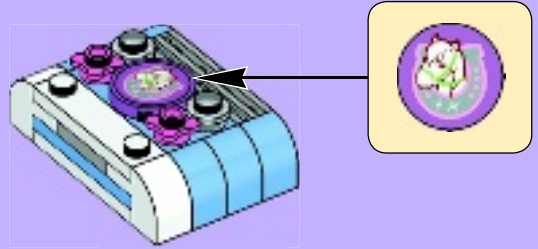



8x

24

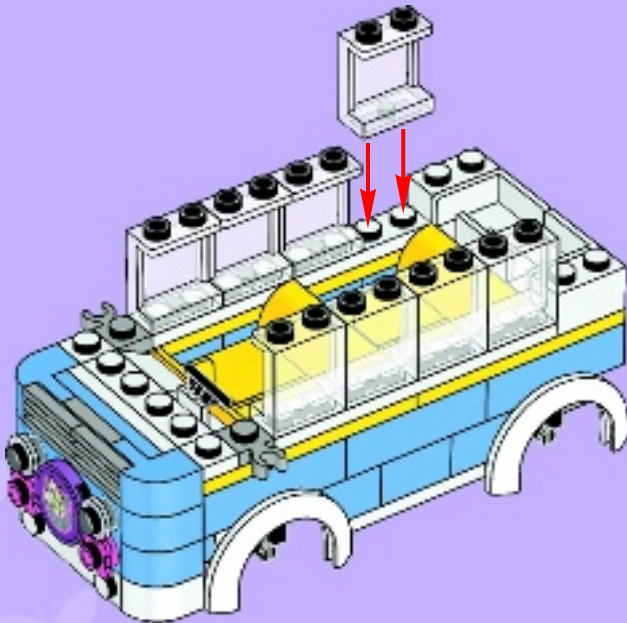

4x

25

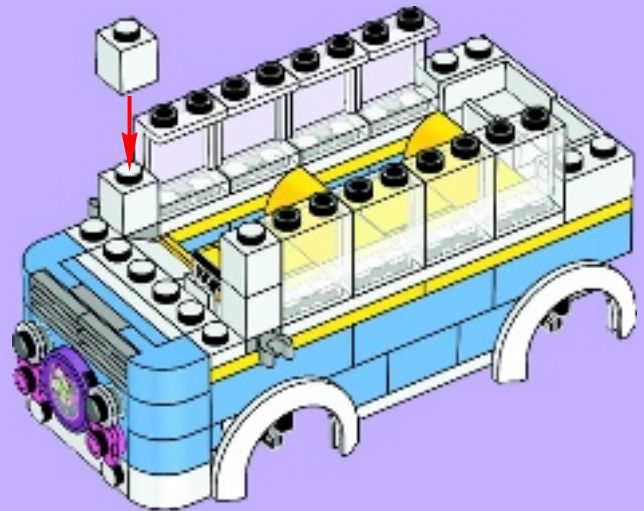

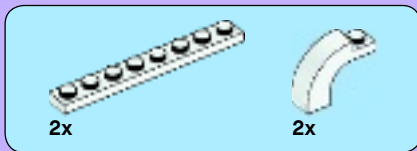

26

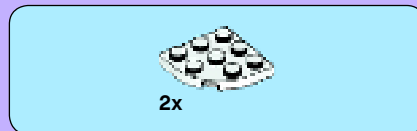
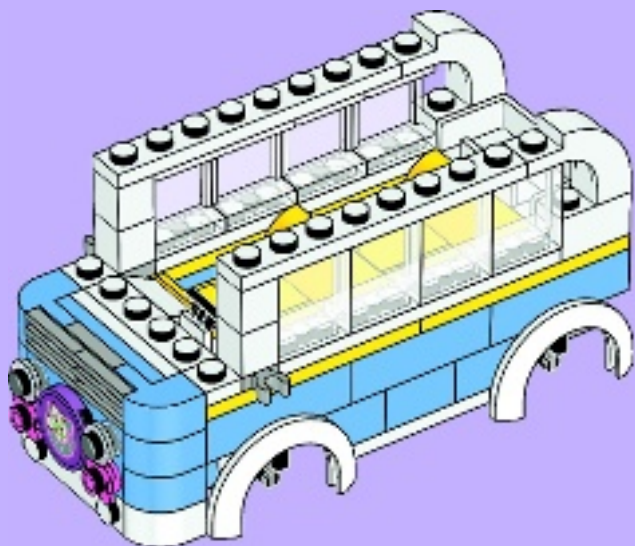

27



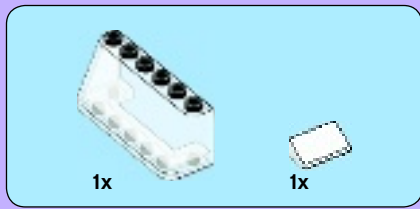

28

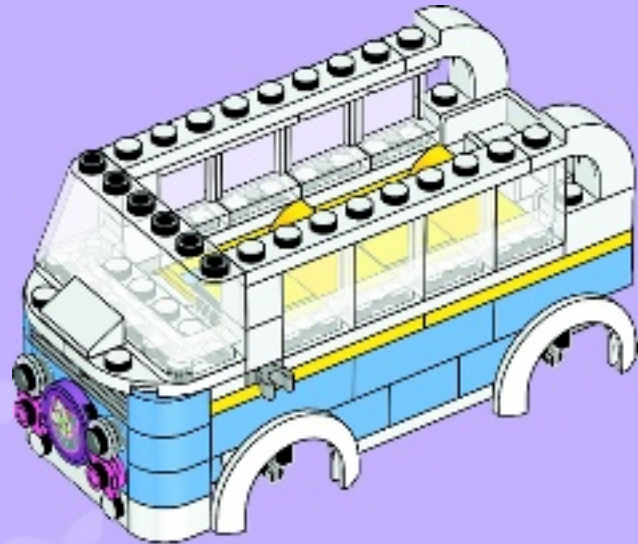

29

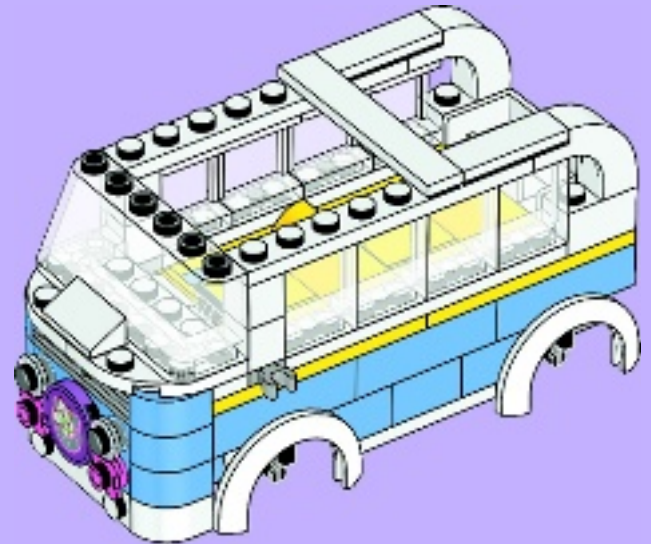



30

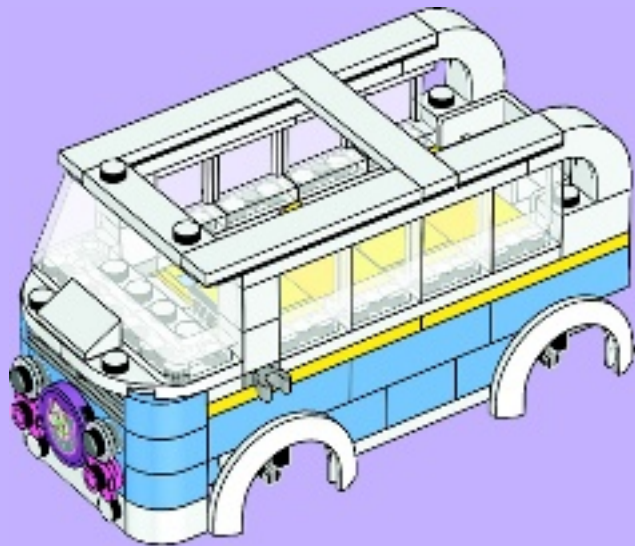

31

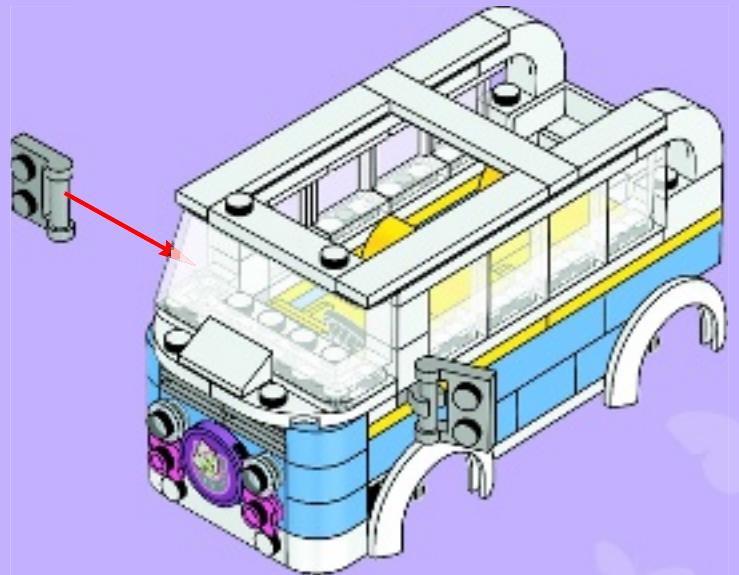



32

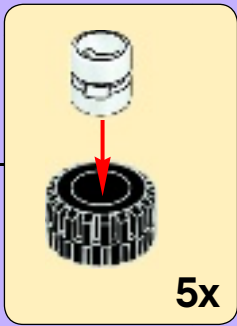
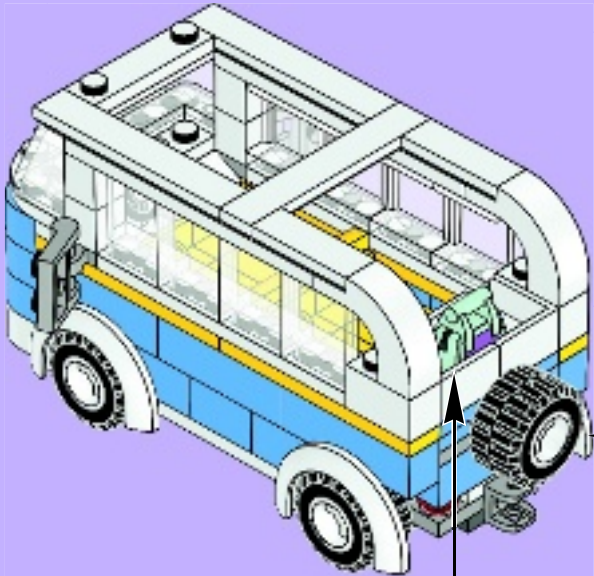

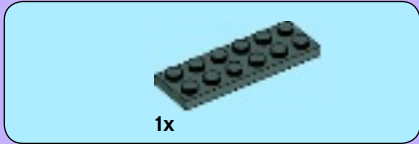

1



2

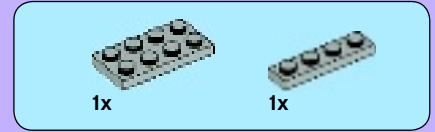
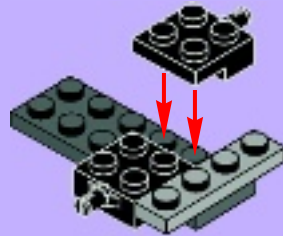

3





4

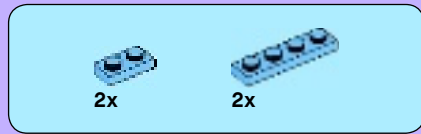
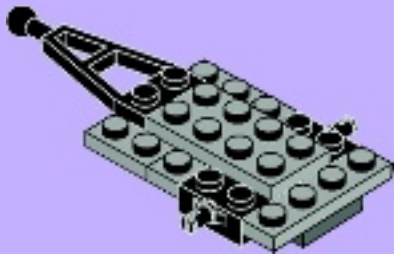

5





6

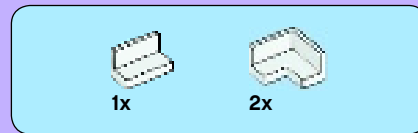
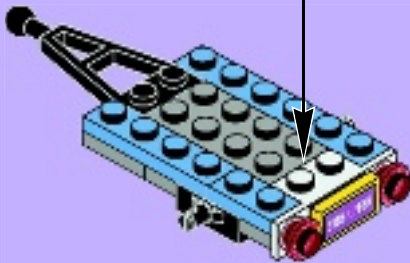
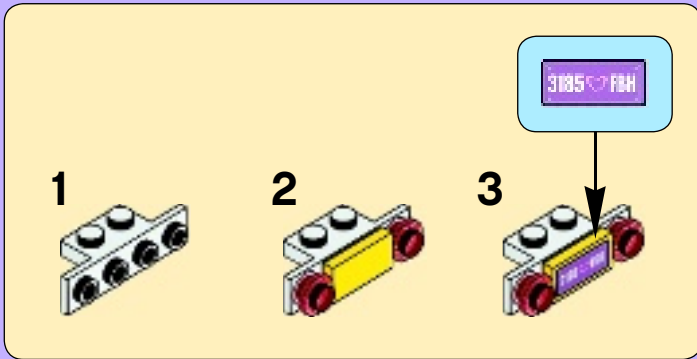

7

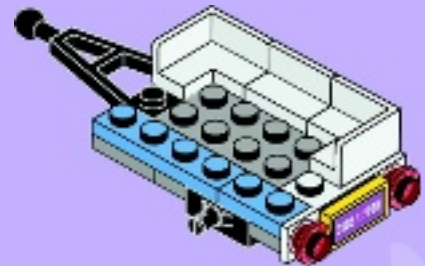

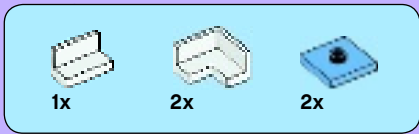

8

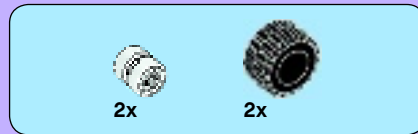
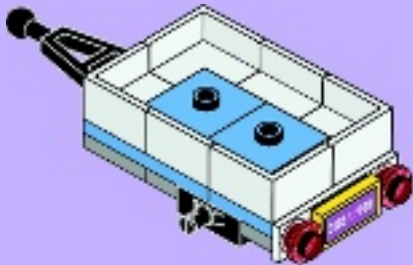

9

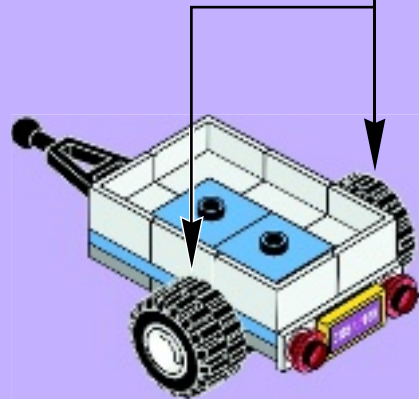
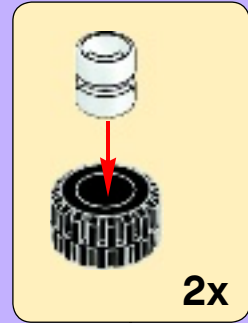

33

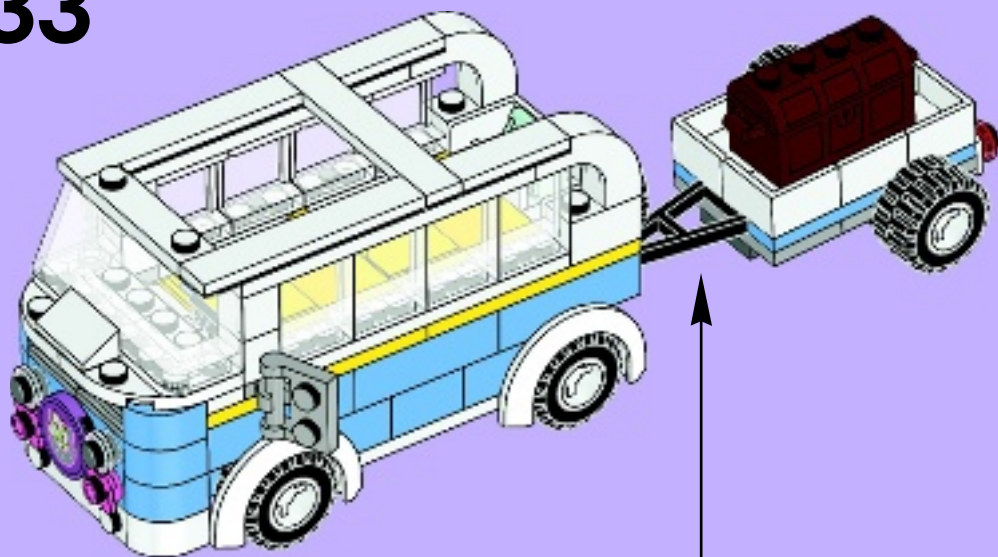

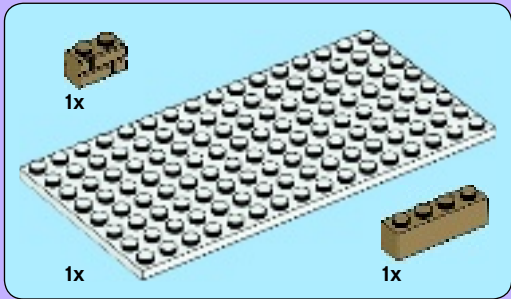
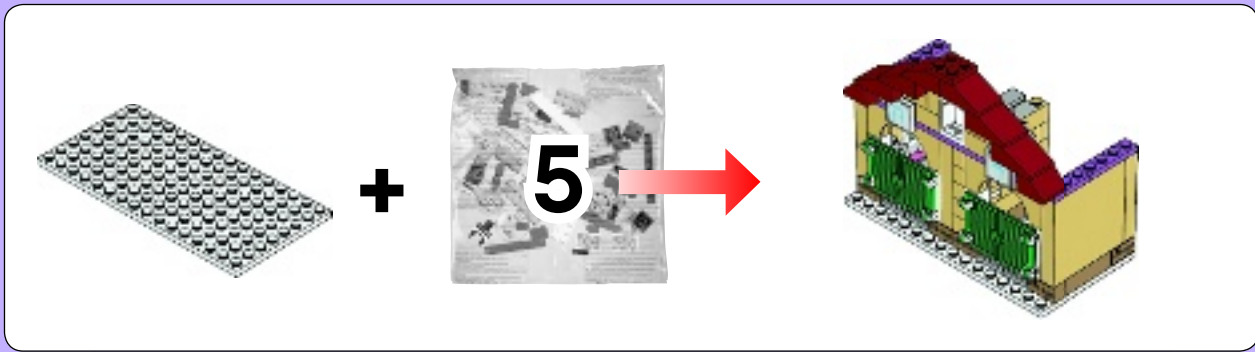

1

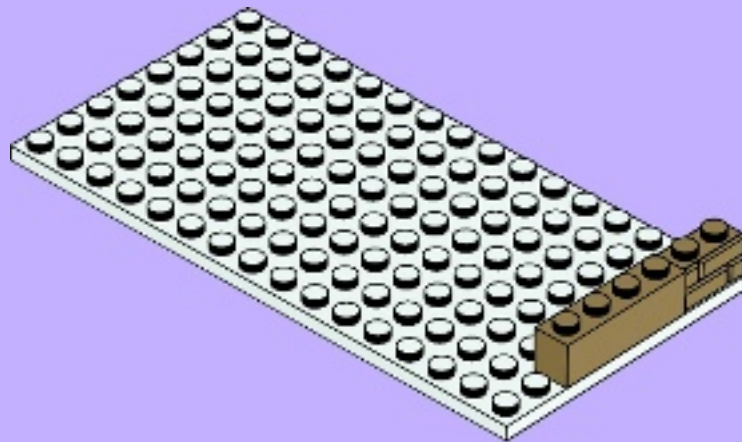



2x



2x

2



1x



1x



1x

3



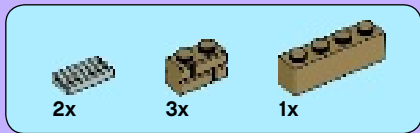

4

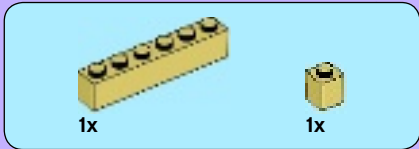

5

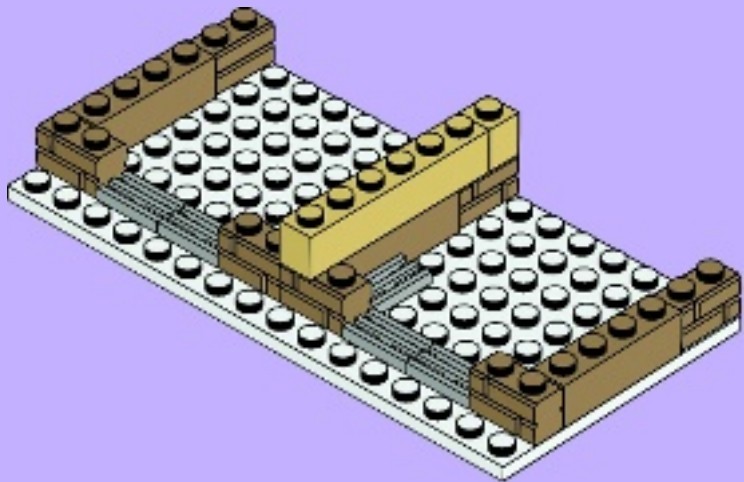



3x



2x



1x

6

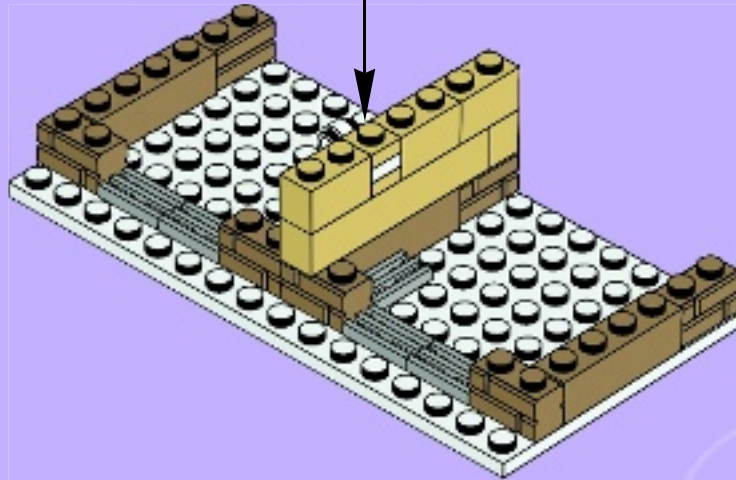
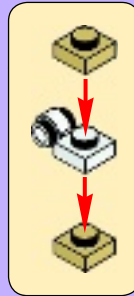



7

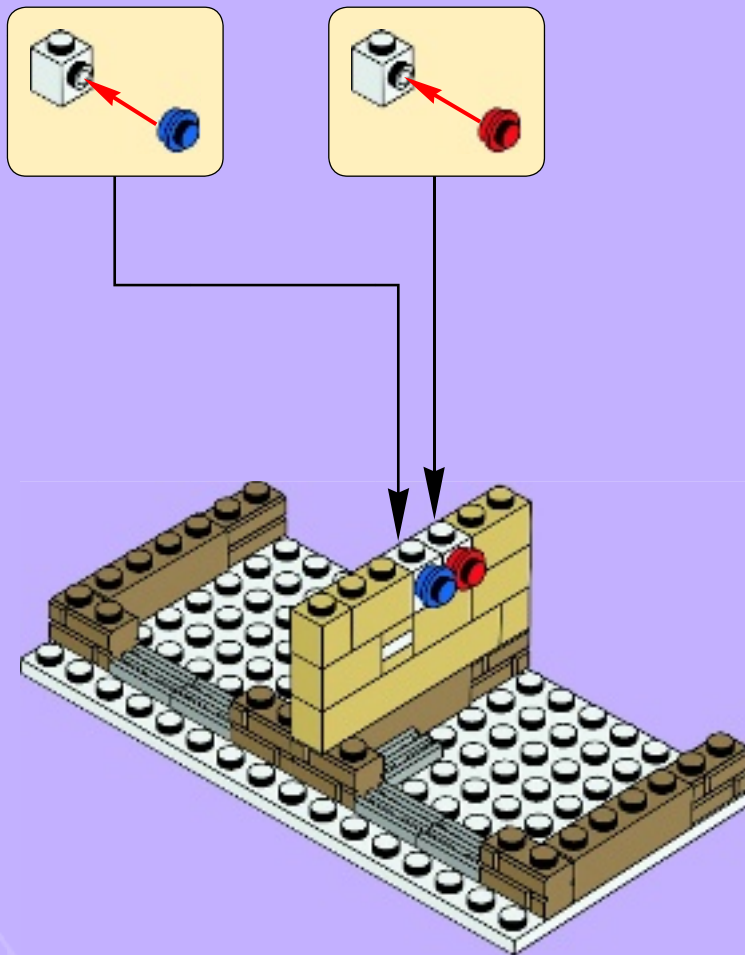

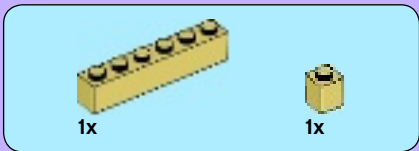

8



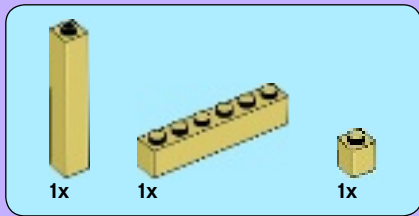

9

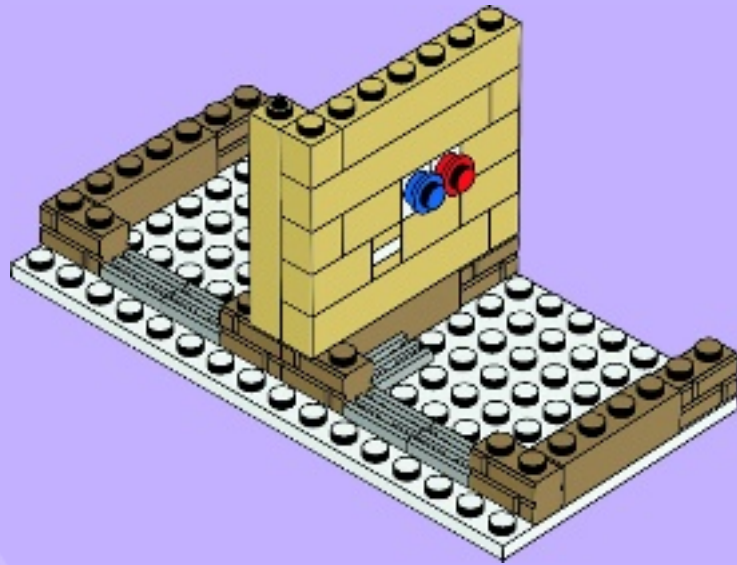

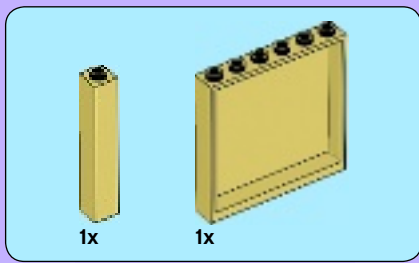

10

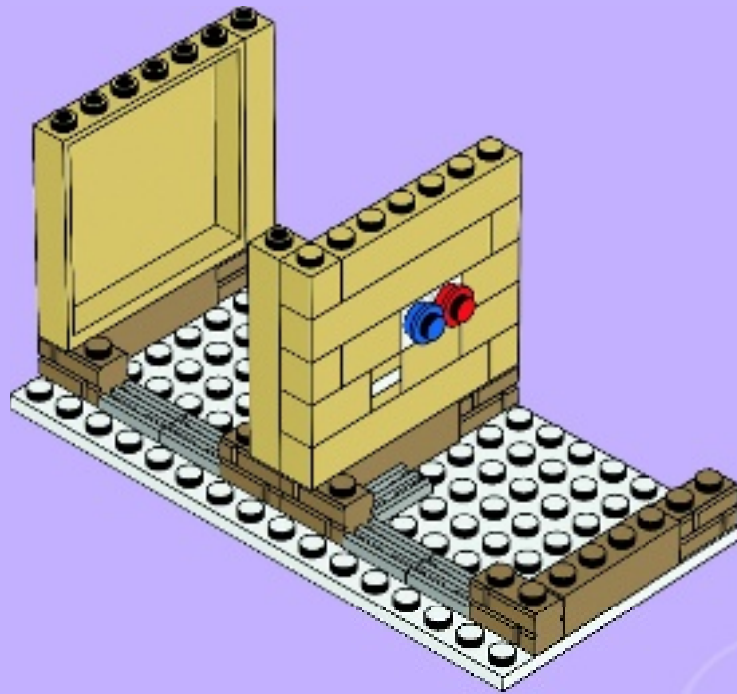

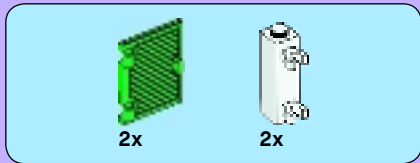

11

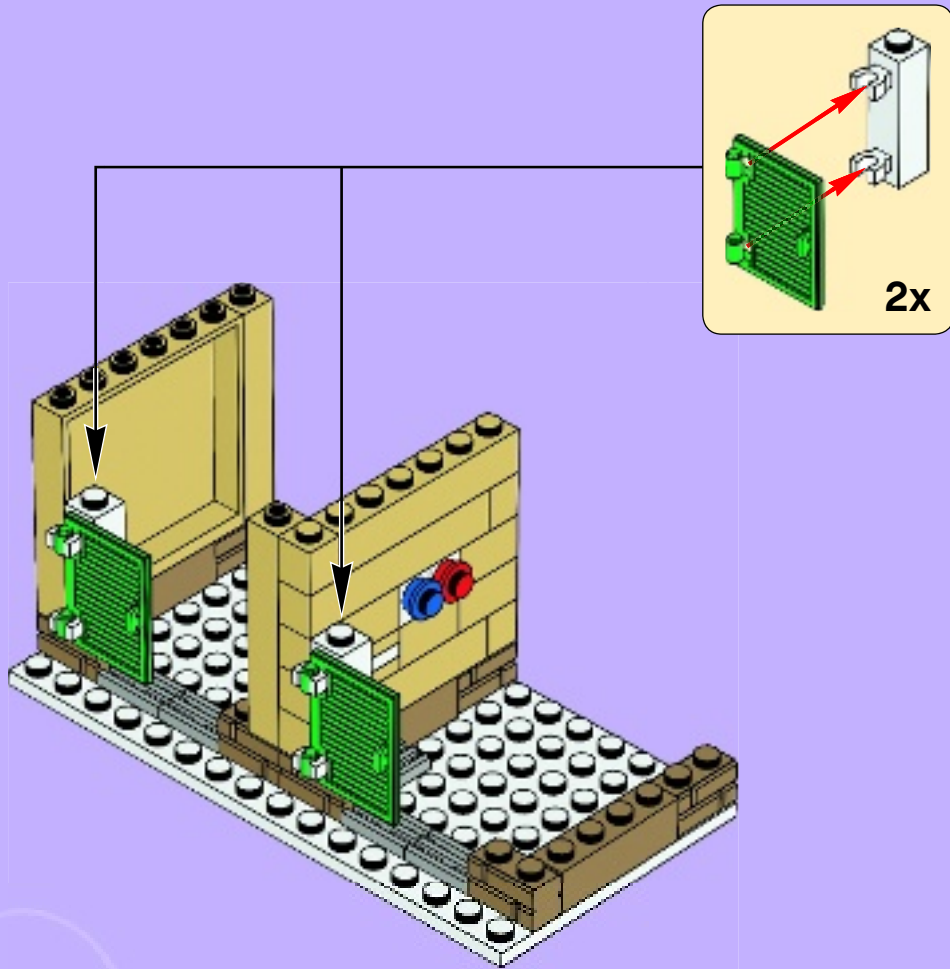

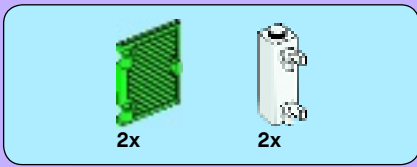

12

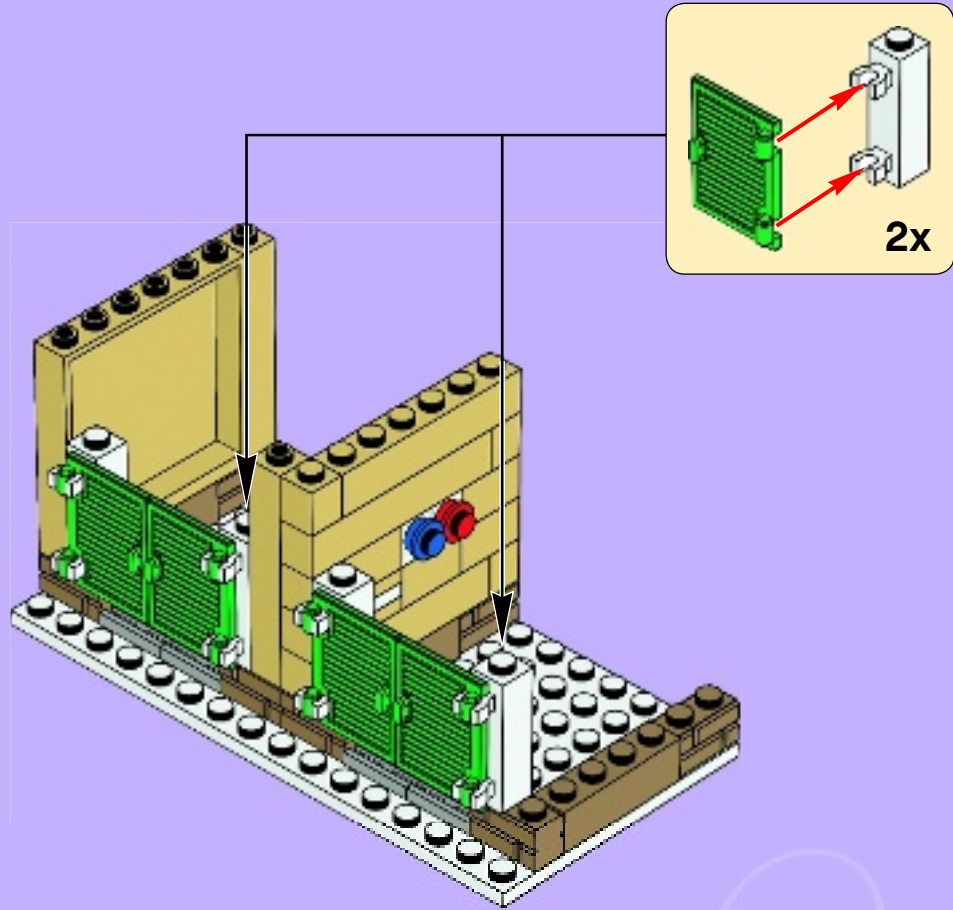

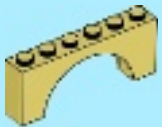

2x

13

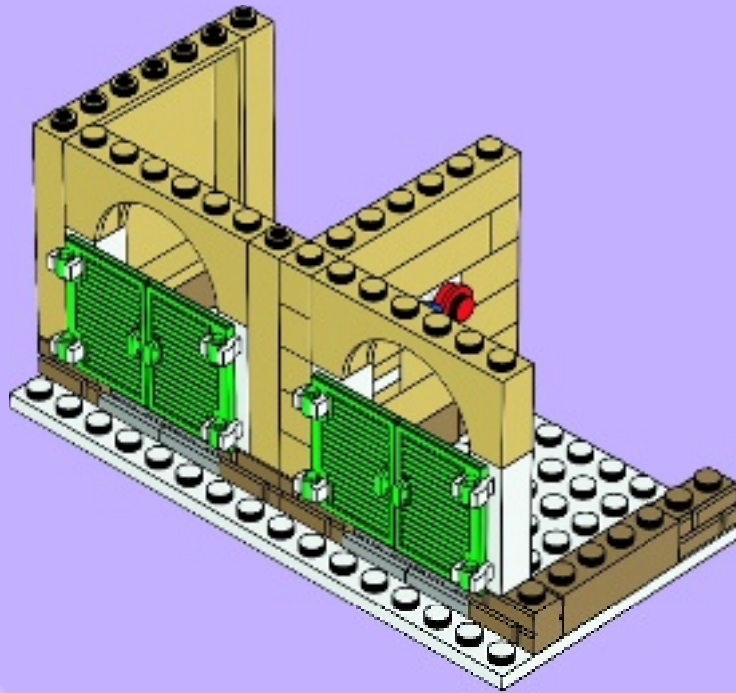



14

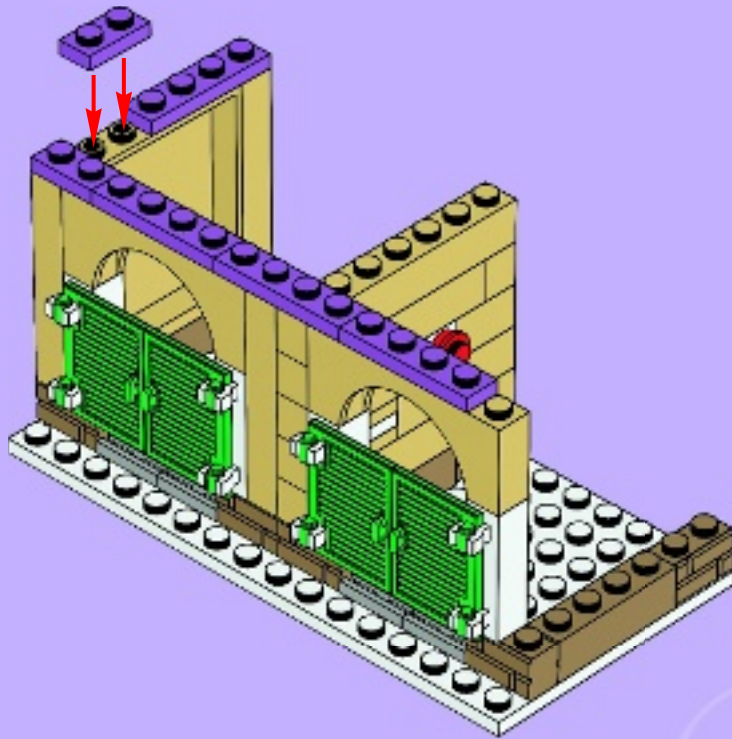



2x



1x



1x

15

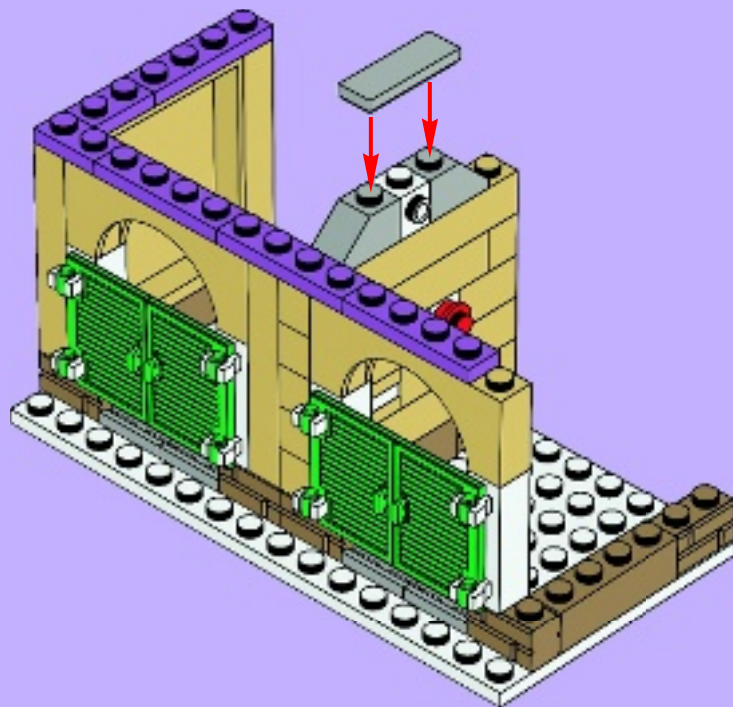



1x



1x

16

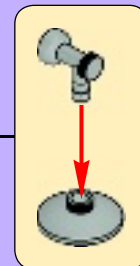
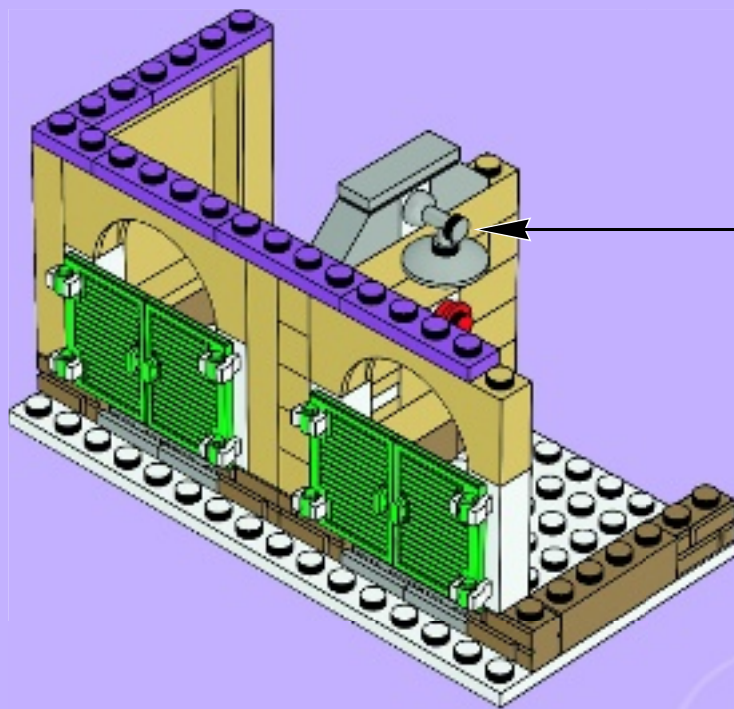

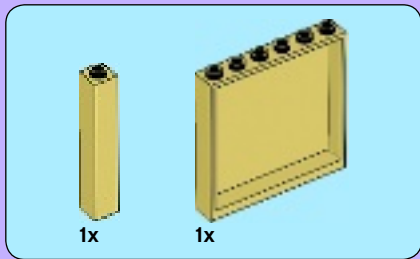

17

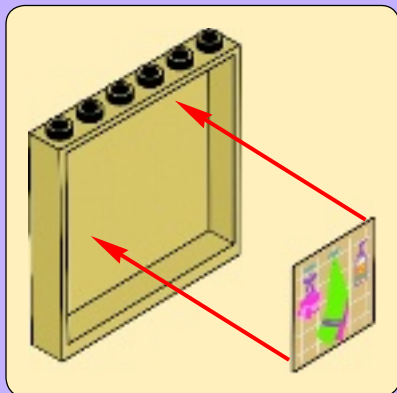
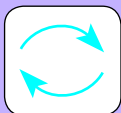



18

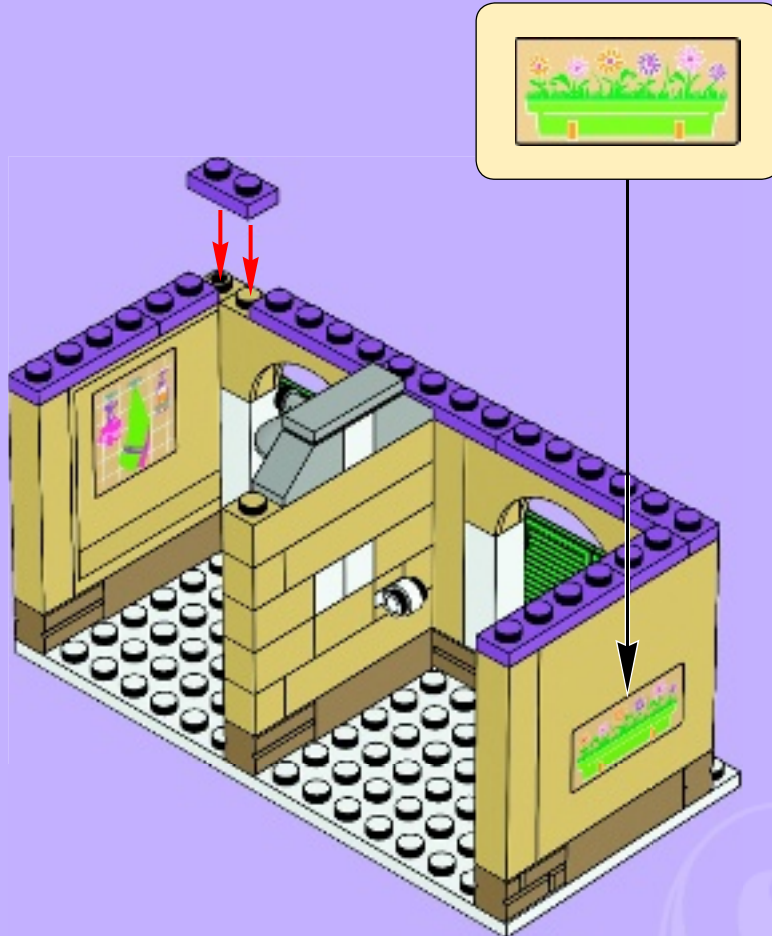

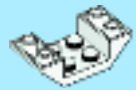

1x

1

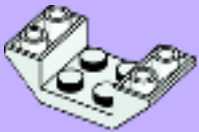

2x

2



1x

3





2x

4

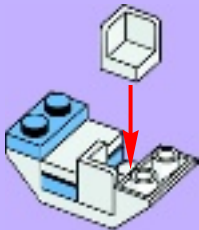

1x



1x

5

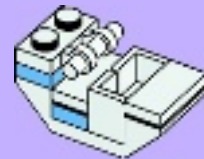



1x

6

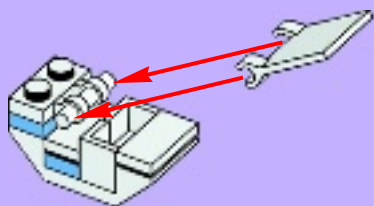

1x

7

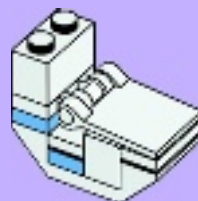



1x



1x

8



1x



1x

9

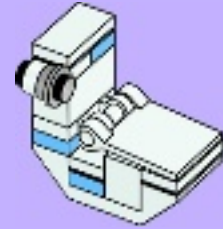

19



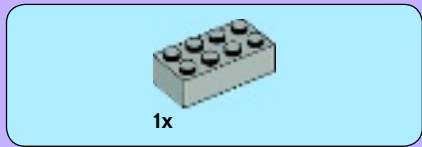

1

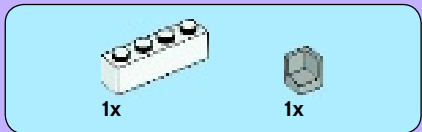
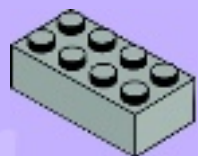

2

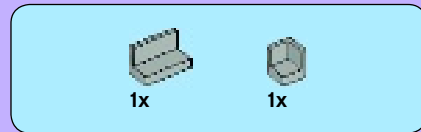
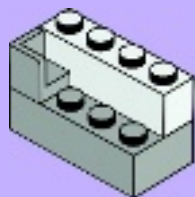

3

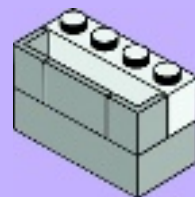

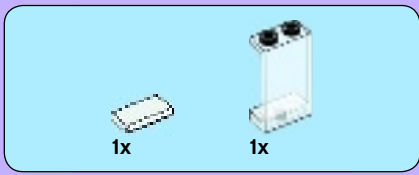

4

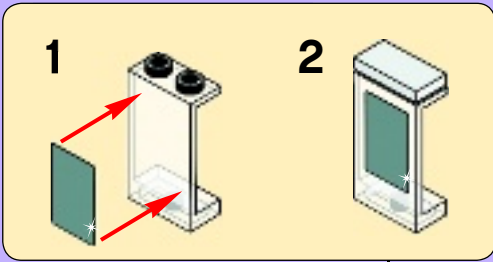

5

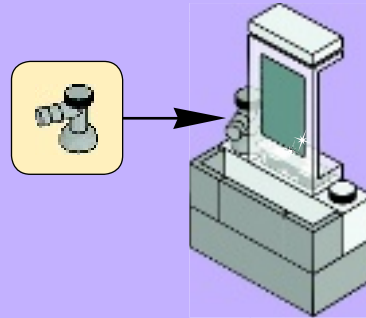



1x



1x

6

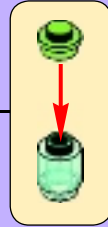
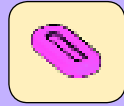

20

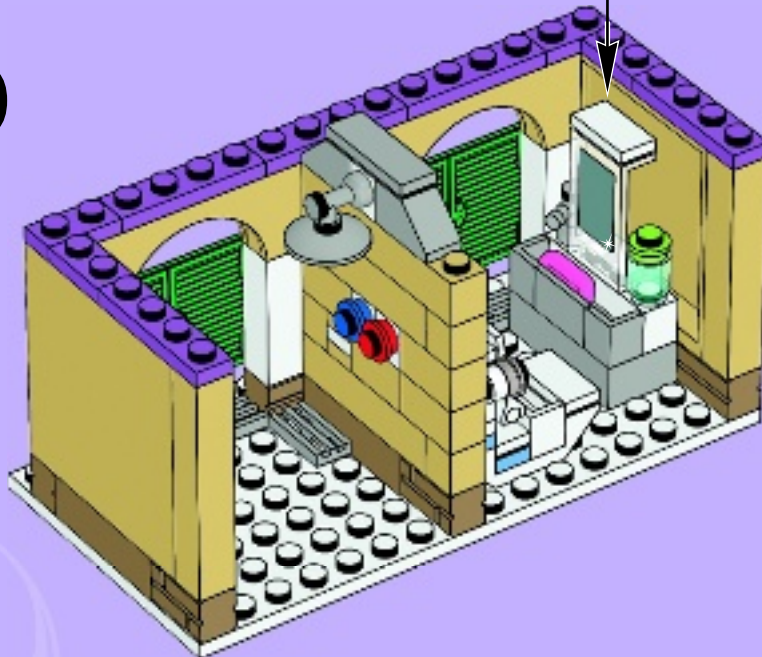



2x



4x



2x

21

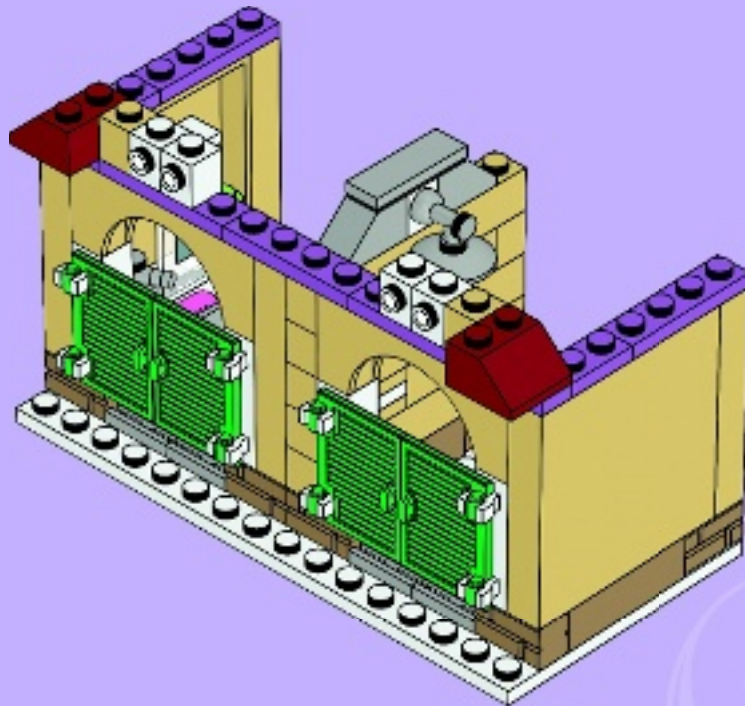
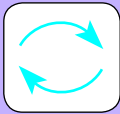

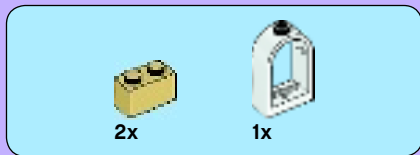

22

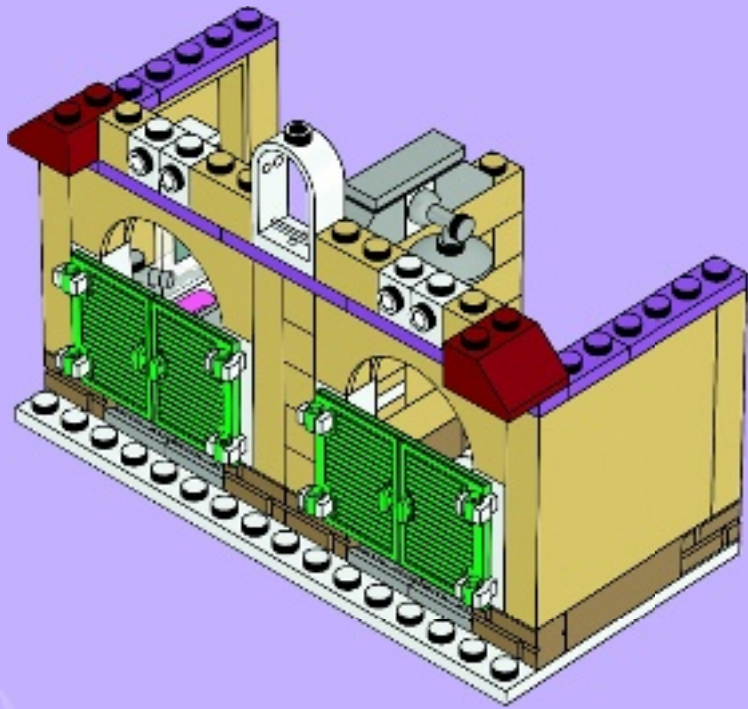



2x

23

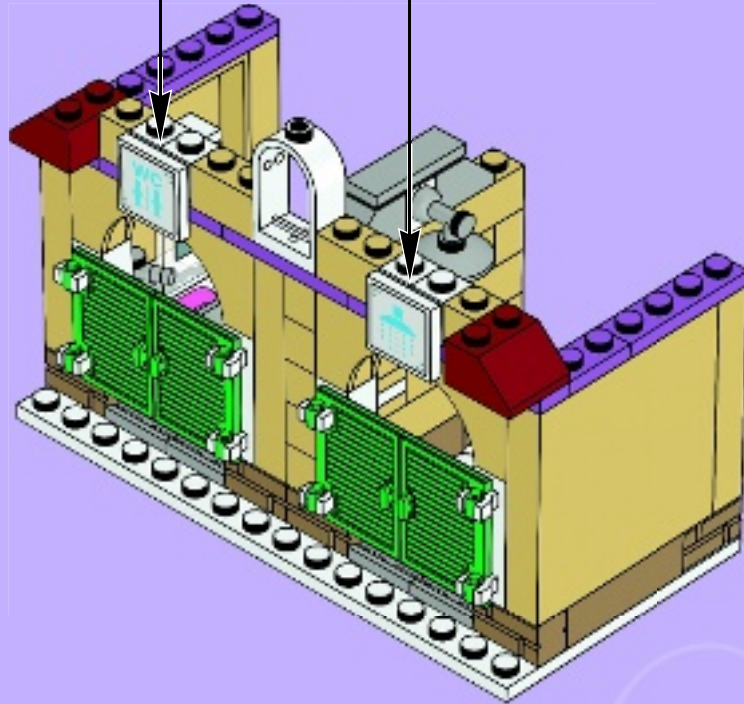
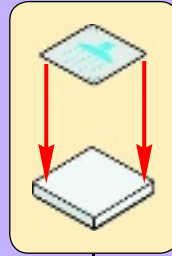
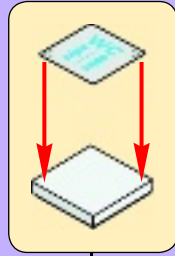



24

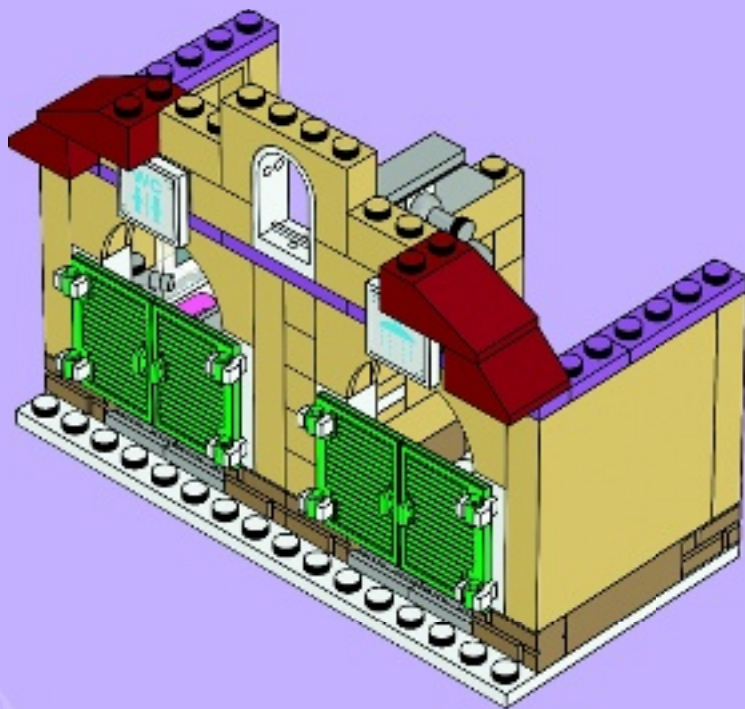



2x

25

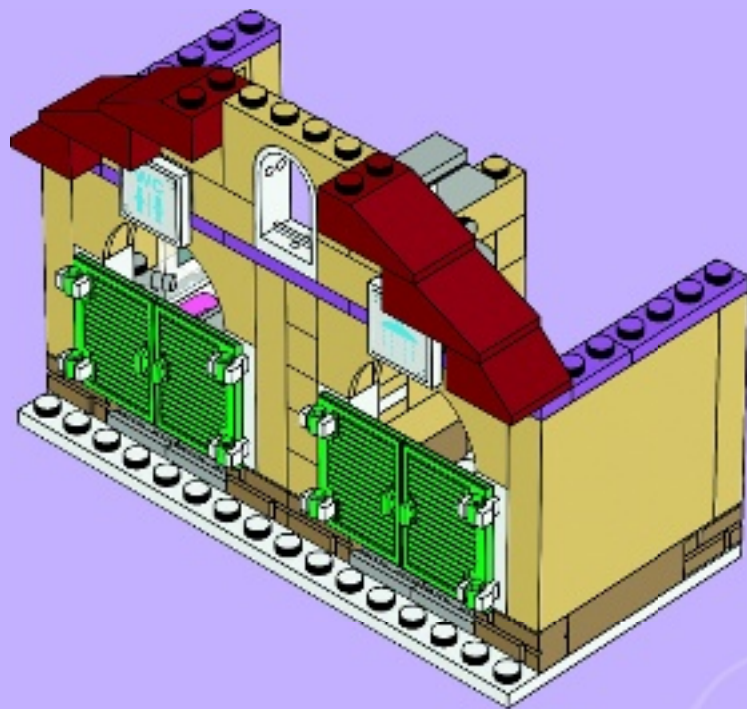



26

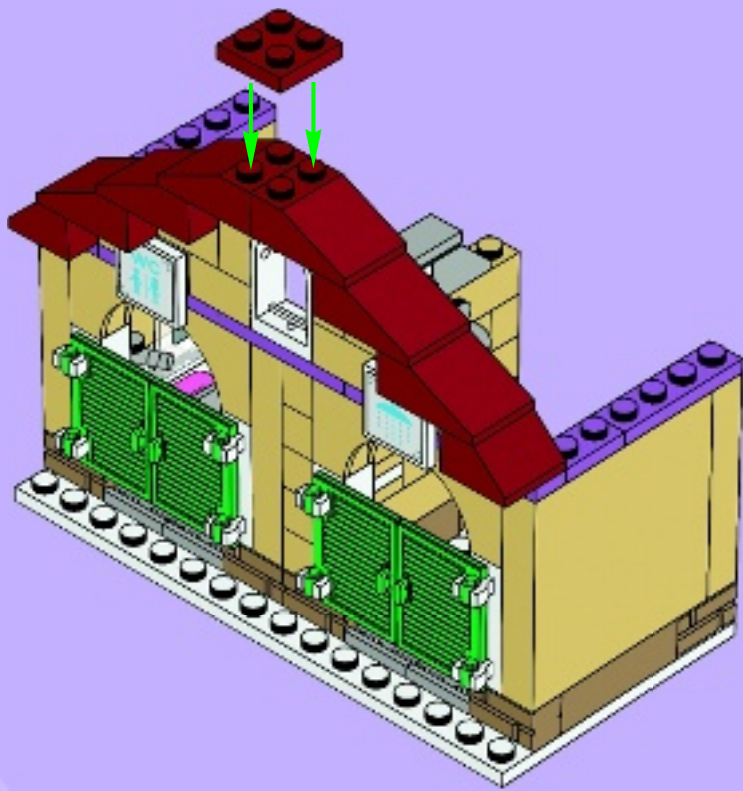

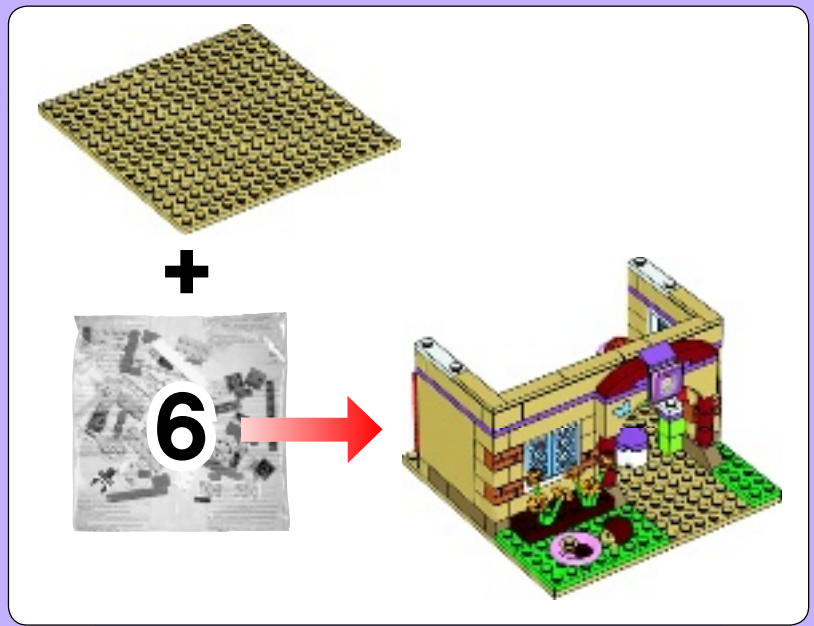

1





3x

2

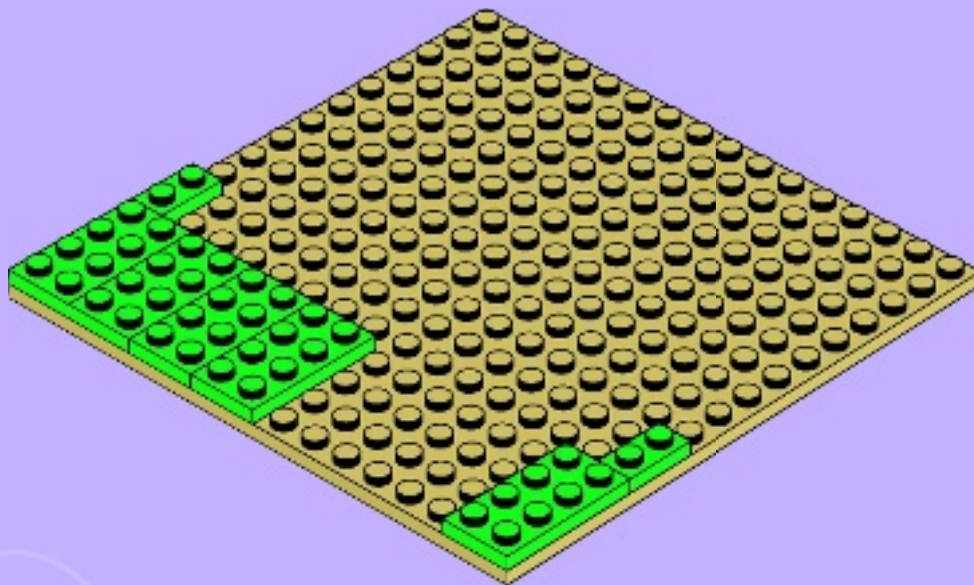



3

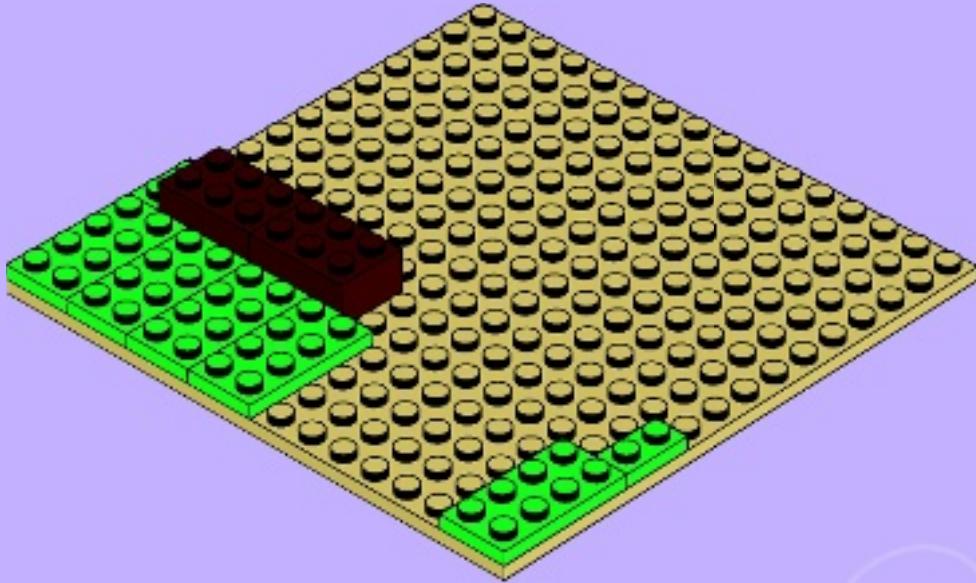

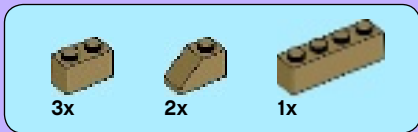

4

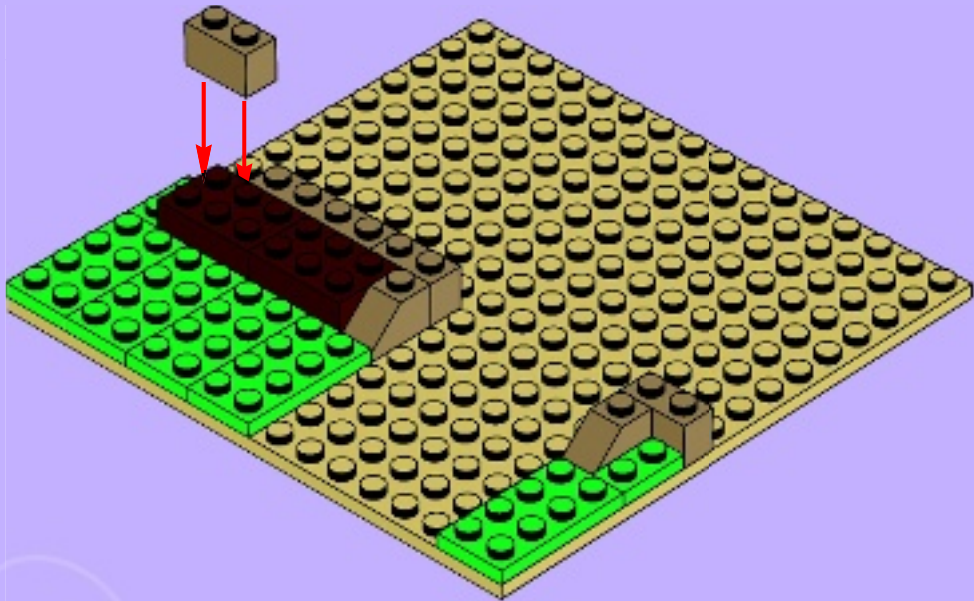

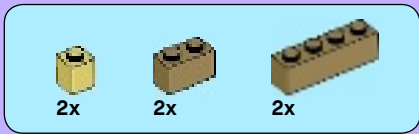

5

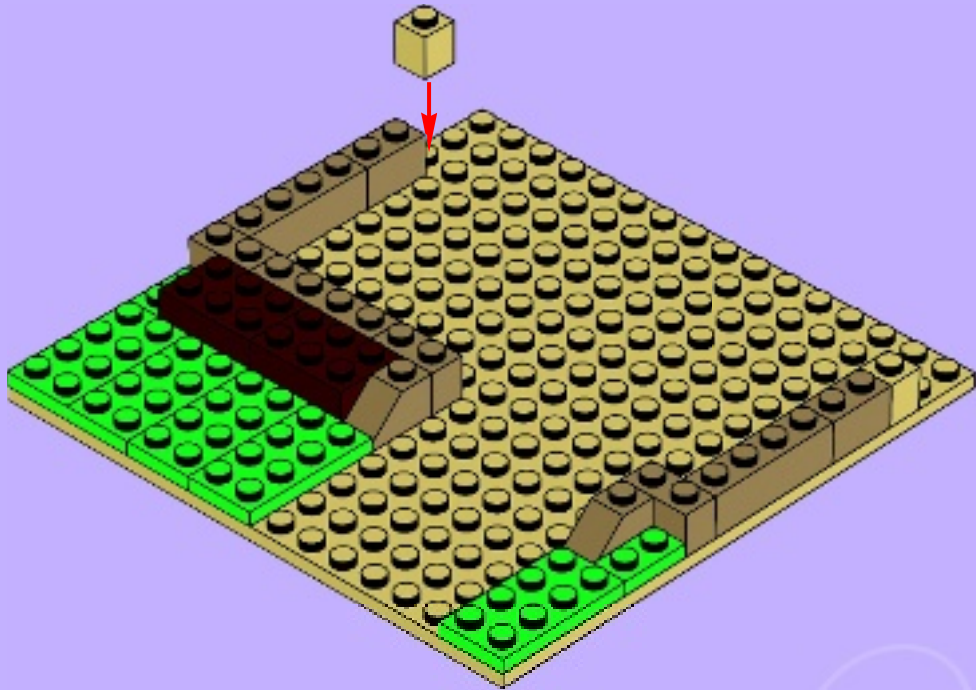

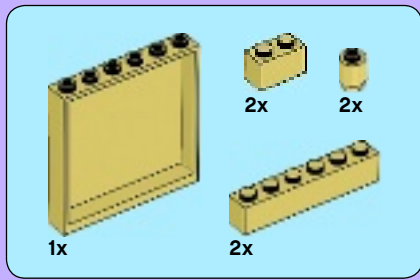

6

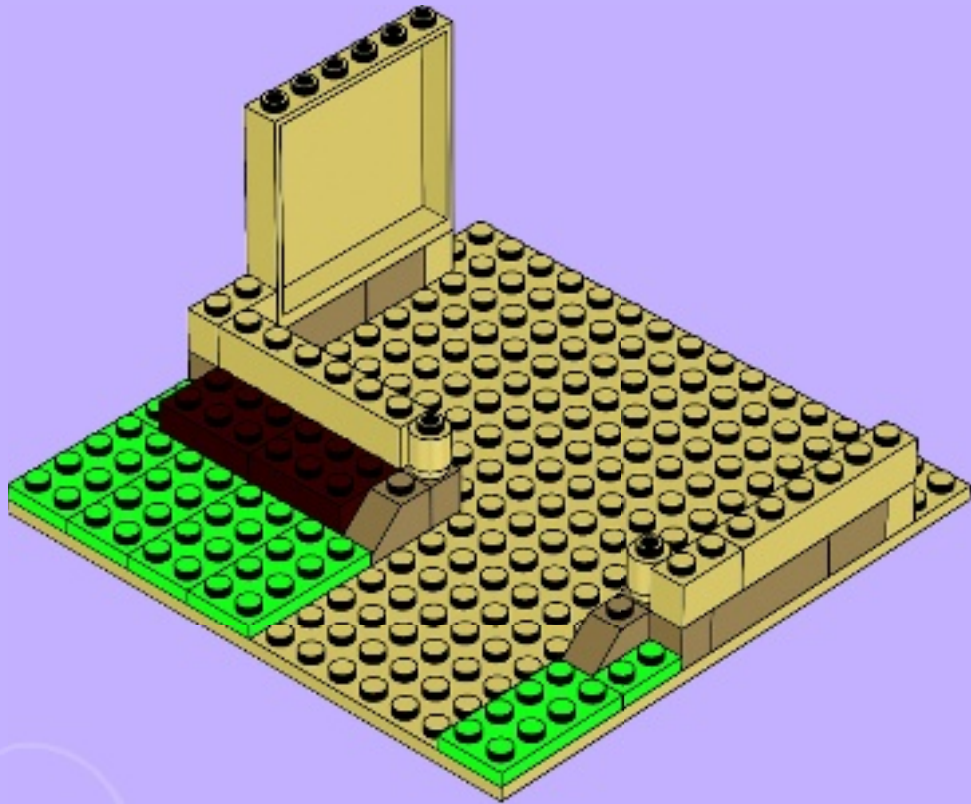

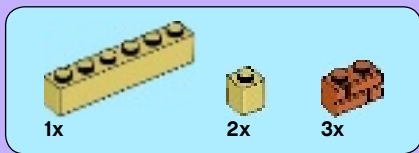

7

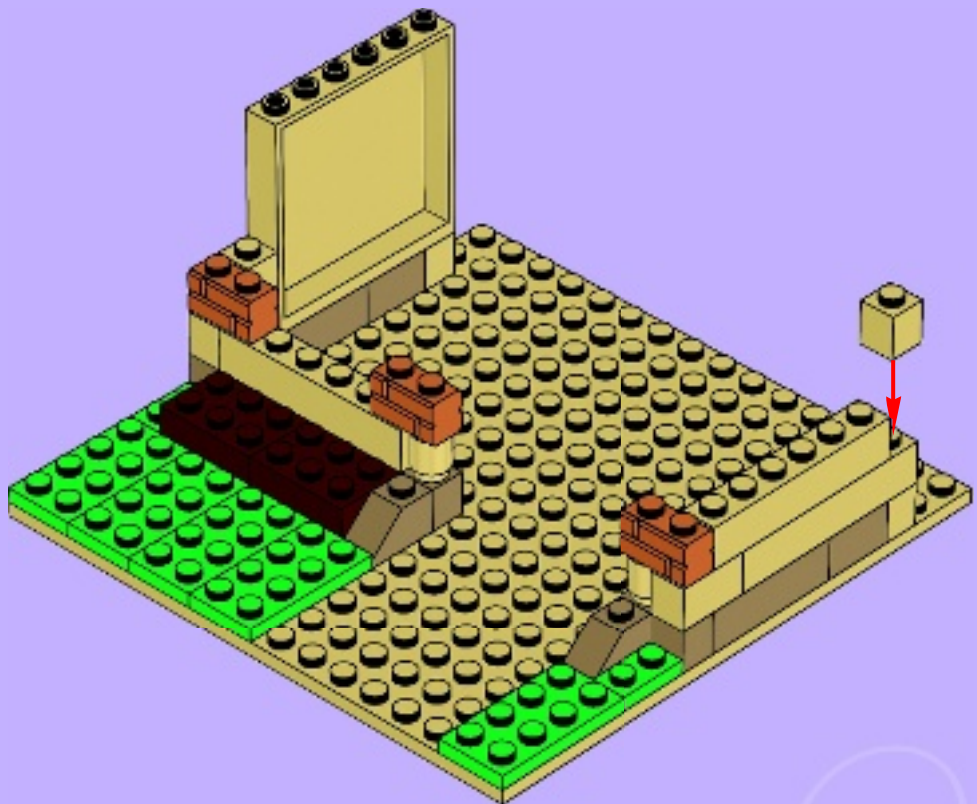



1x



2x



2x

8

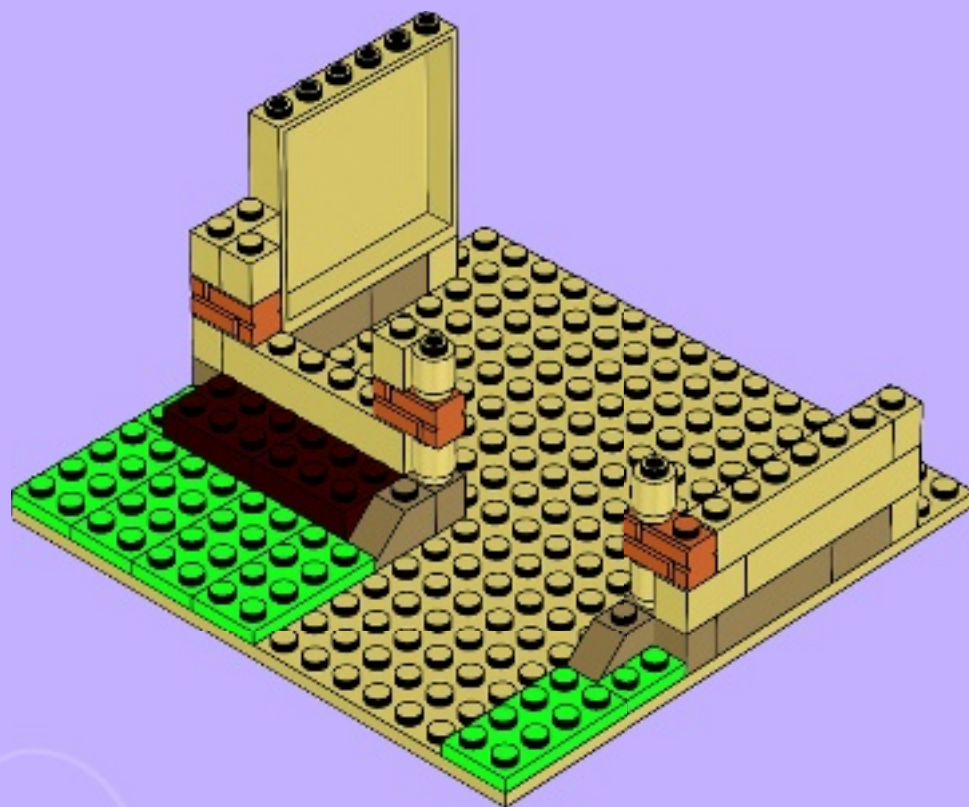



2x



1x

9

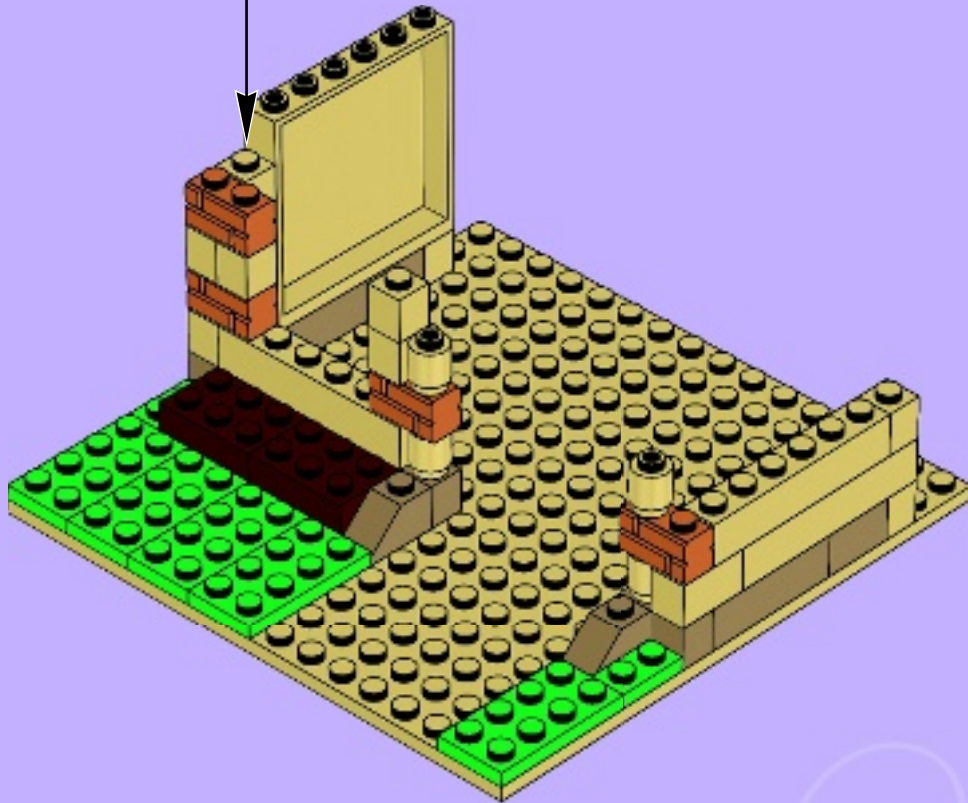

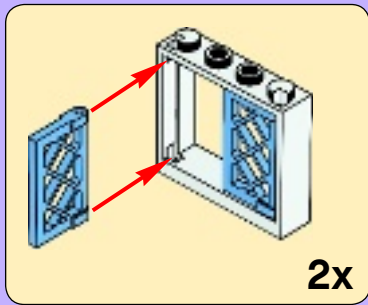
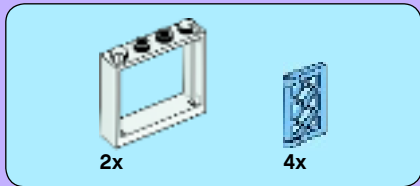

10

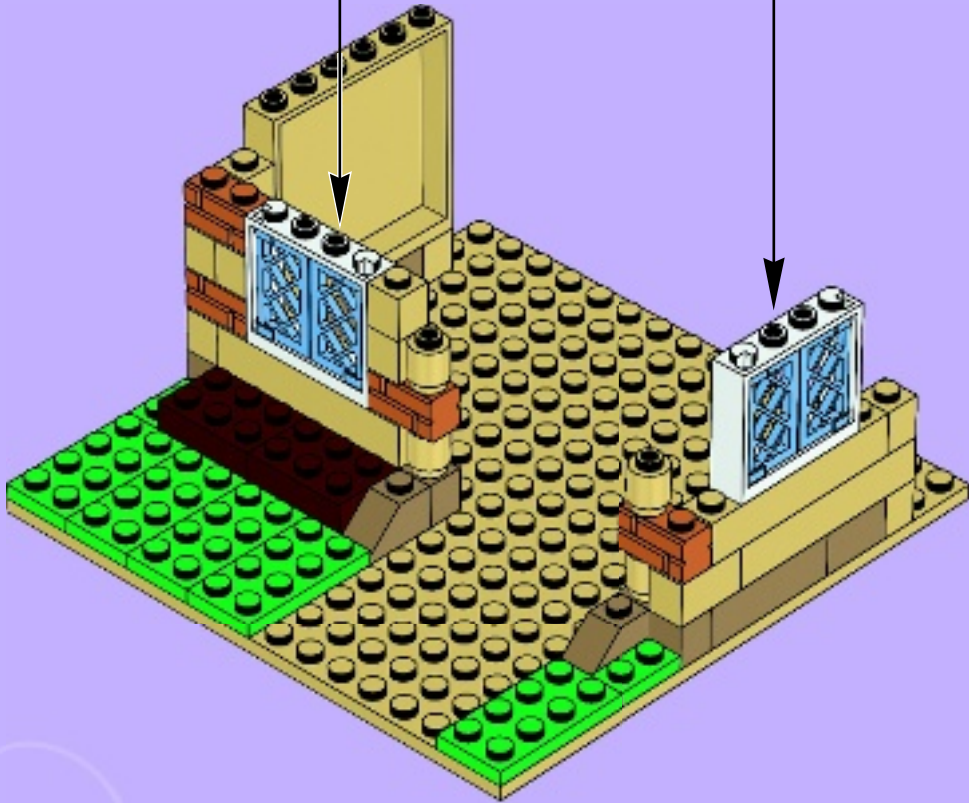

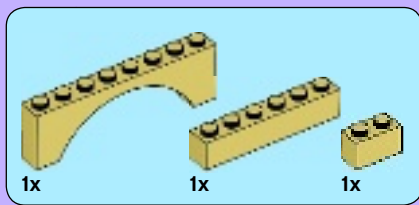

11





6x

12

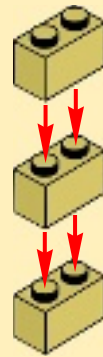

2x

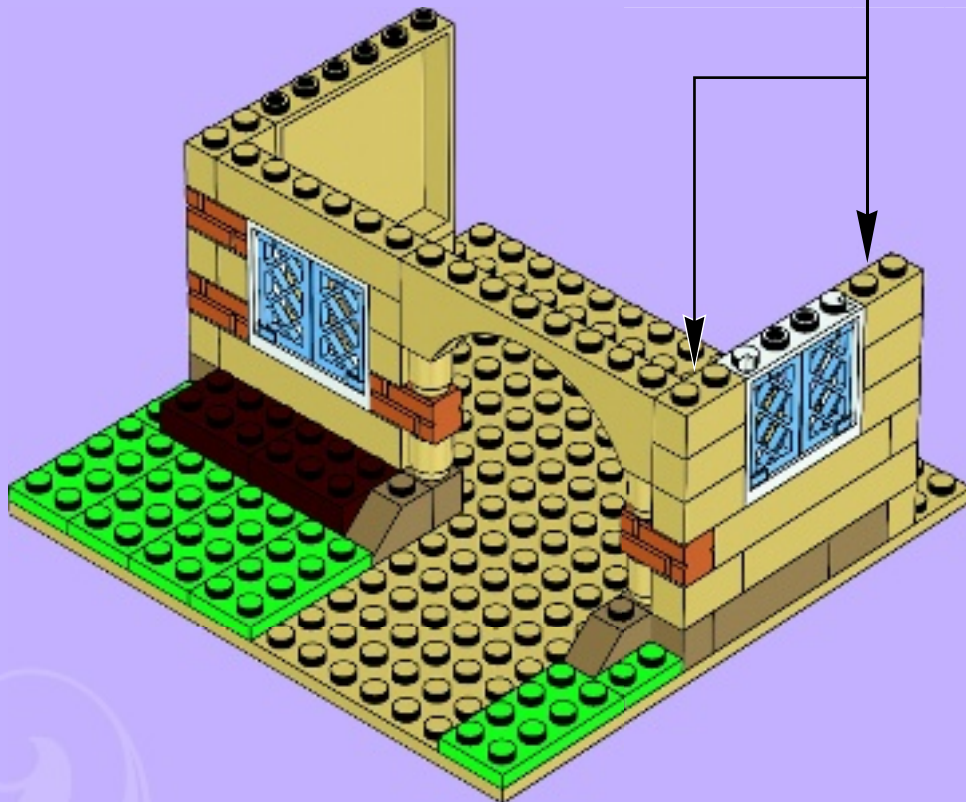



6x

13



2x

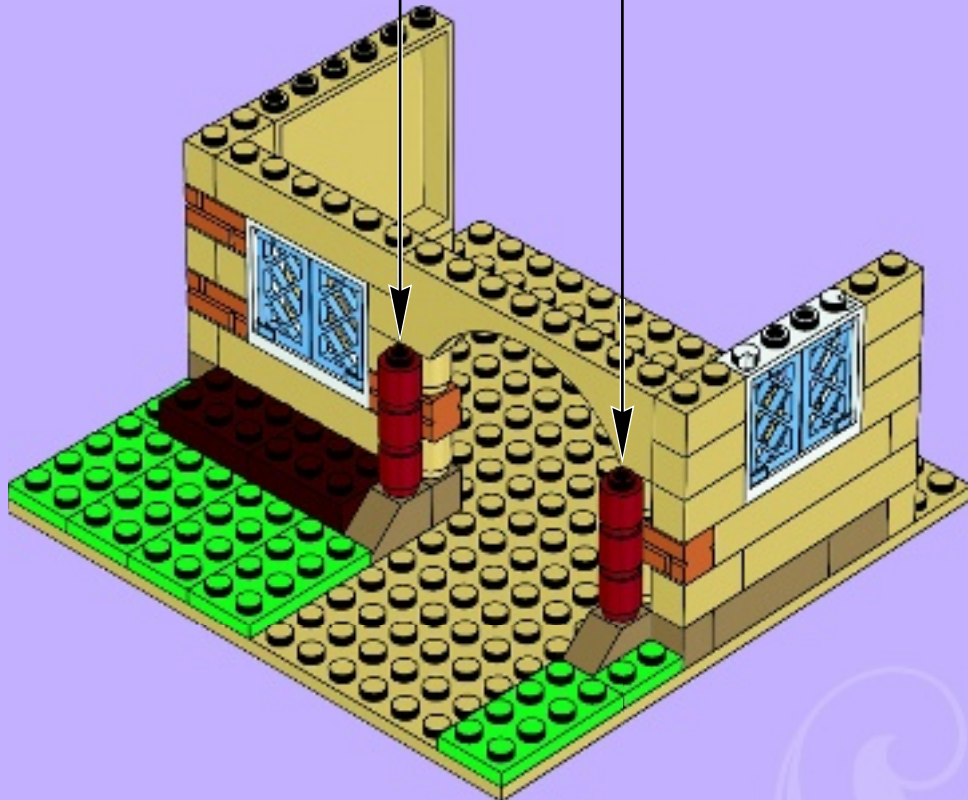

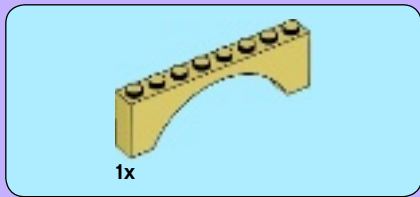

14

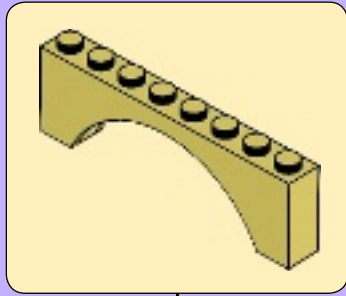

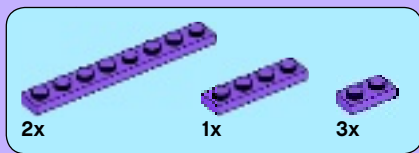

15



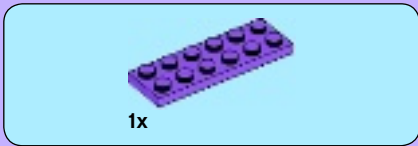

16



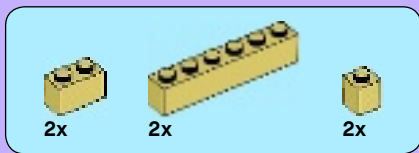

17



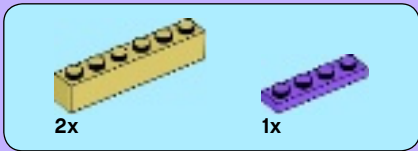

18

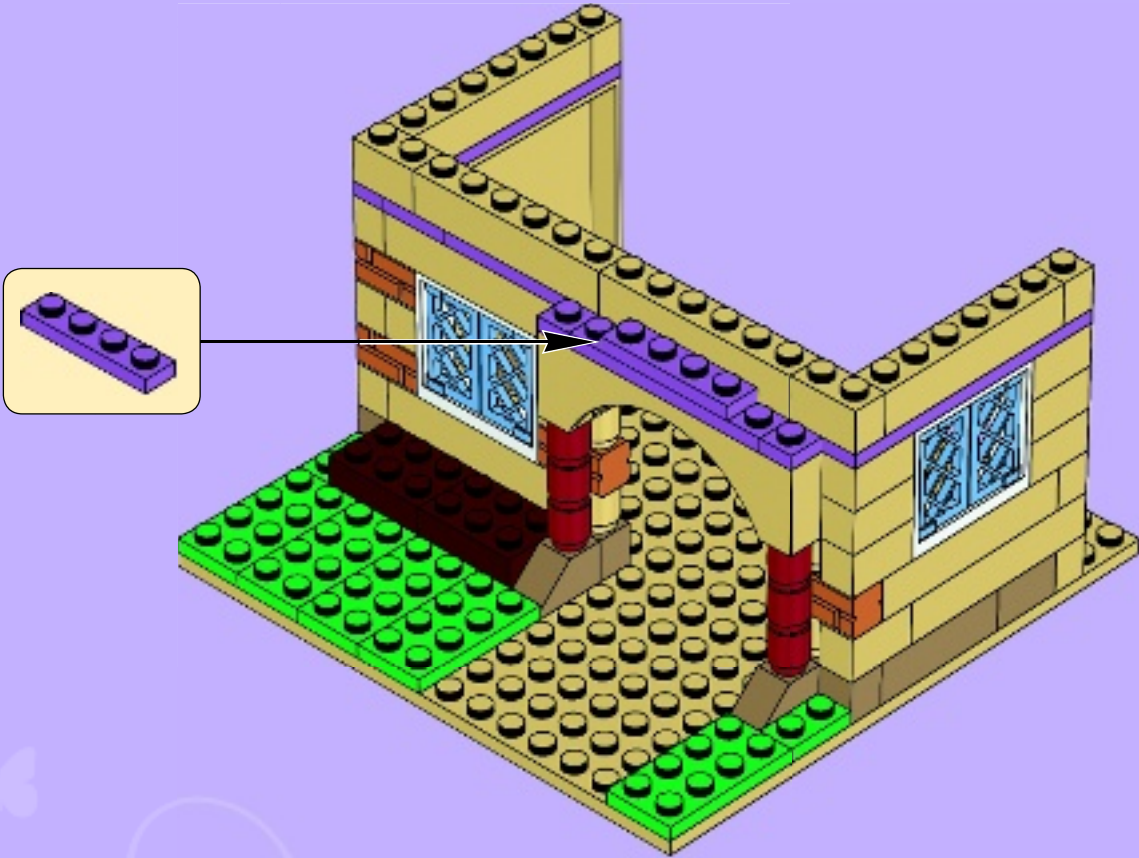



19

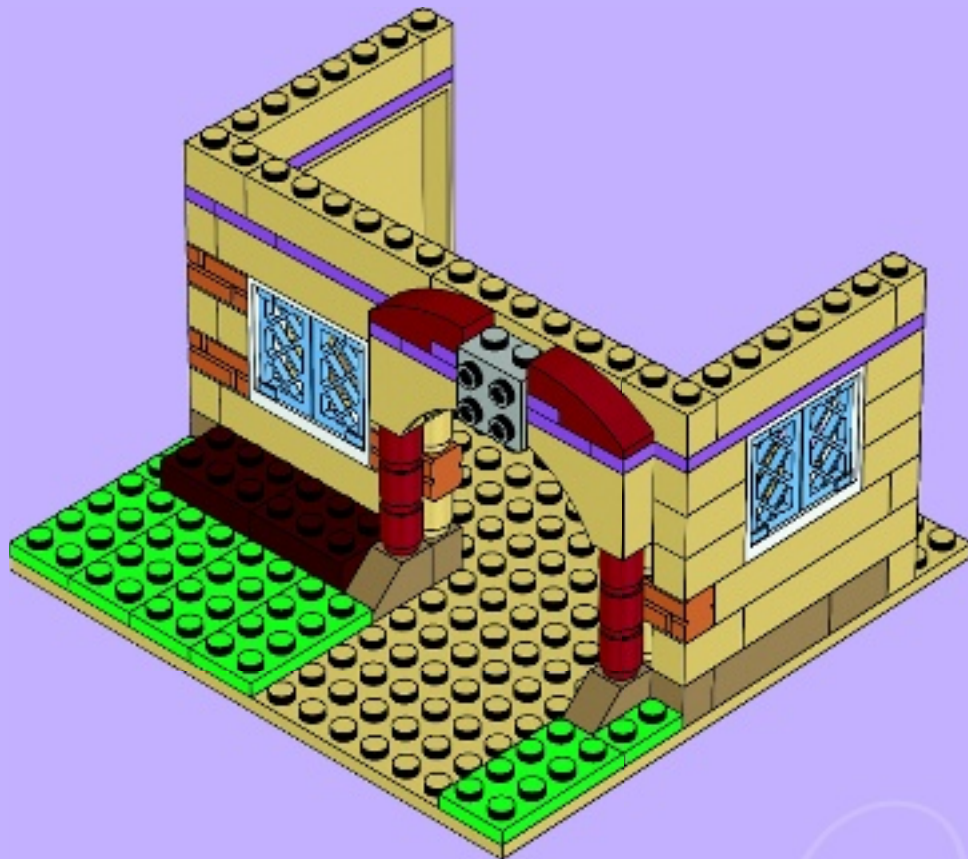

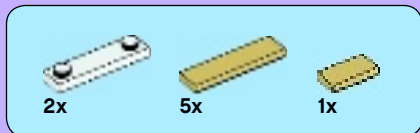

20



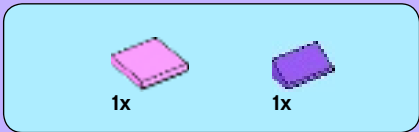

21

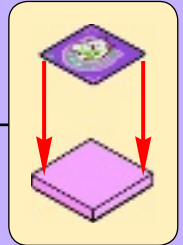
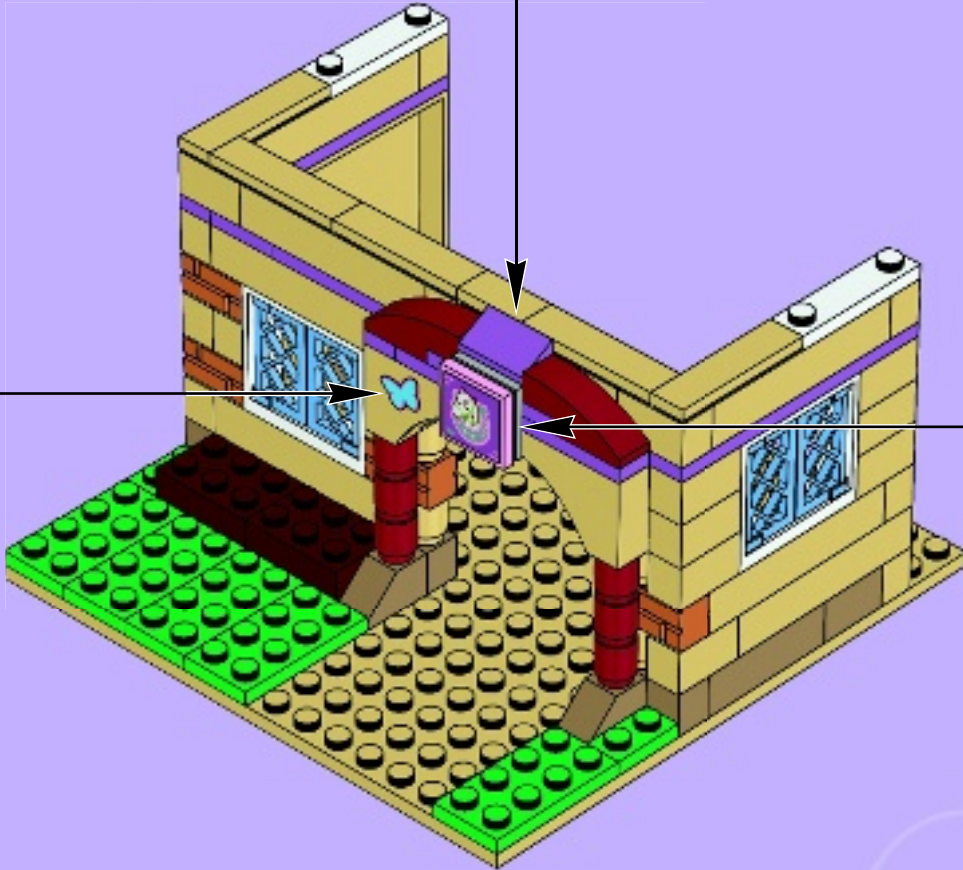
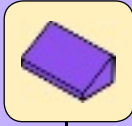



1x



1x

1

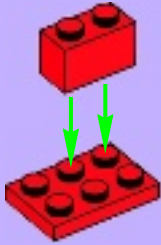

1x



2x

2



1x

3

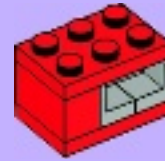

2x



2x

4



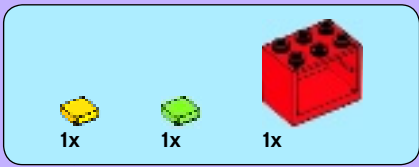

5

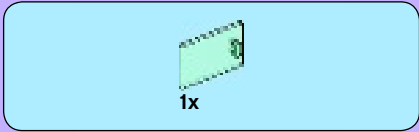

6

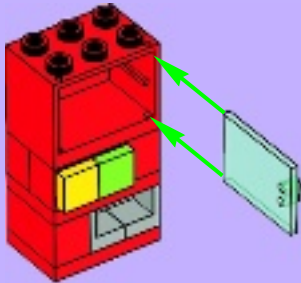

7

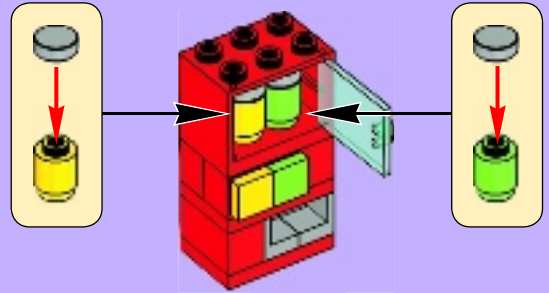

22

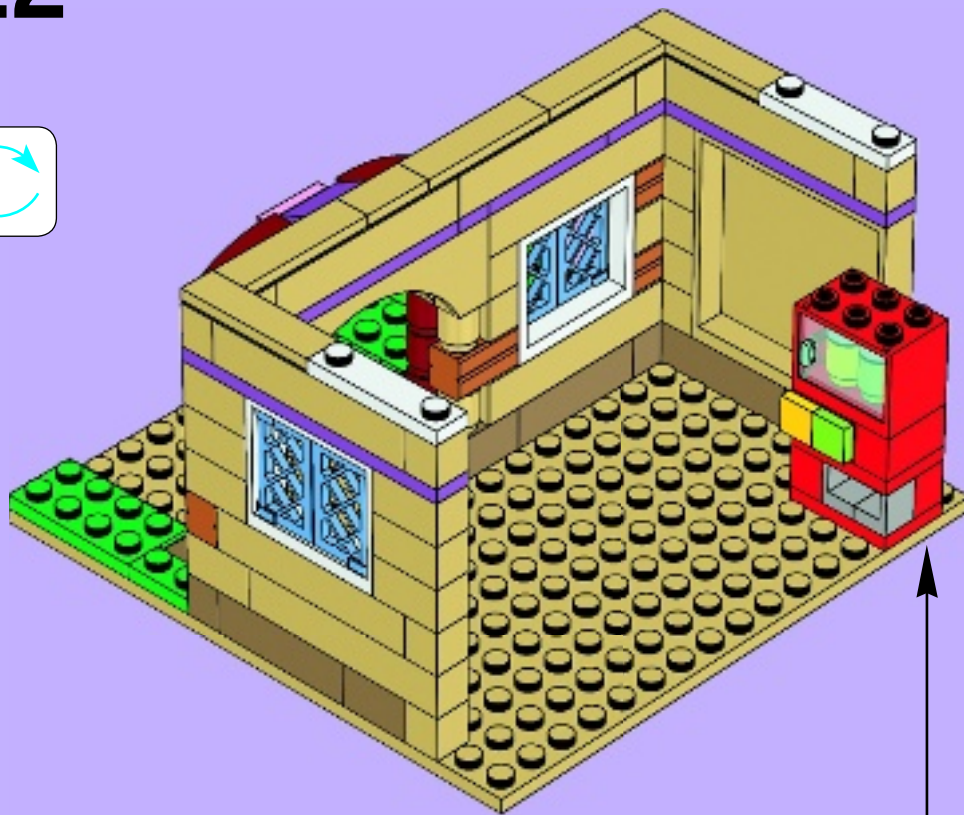
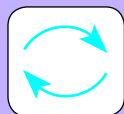

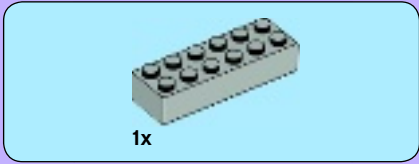

1

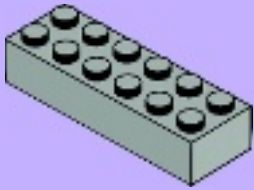

2

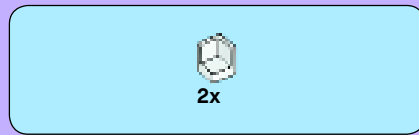
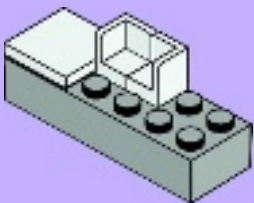

3

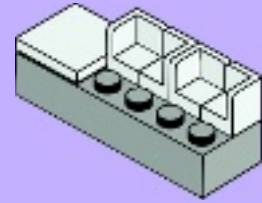

4

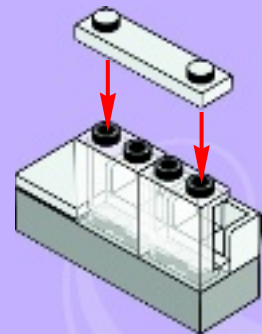

3x

2x

5

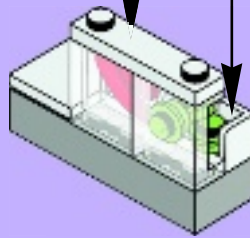
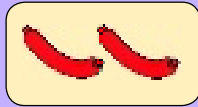

23



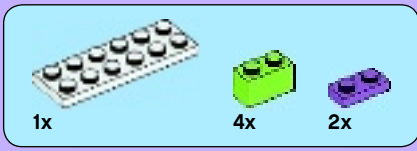

24

1

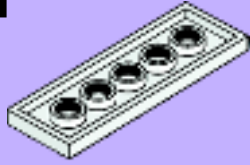

2



3

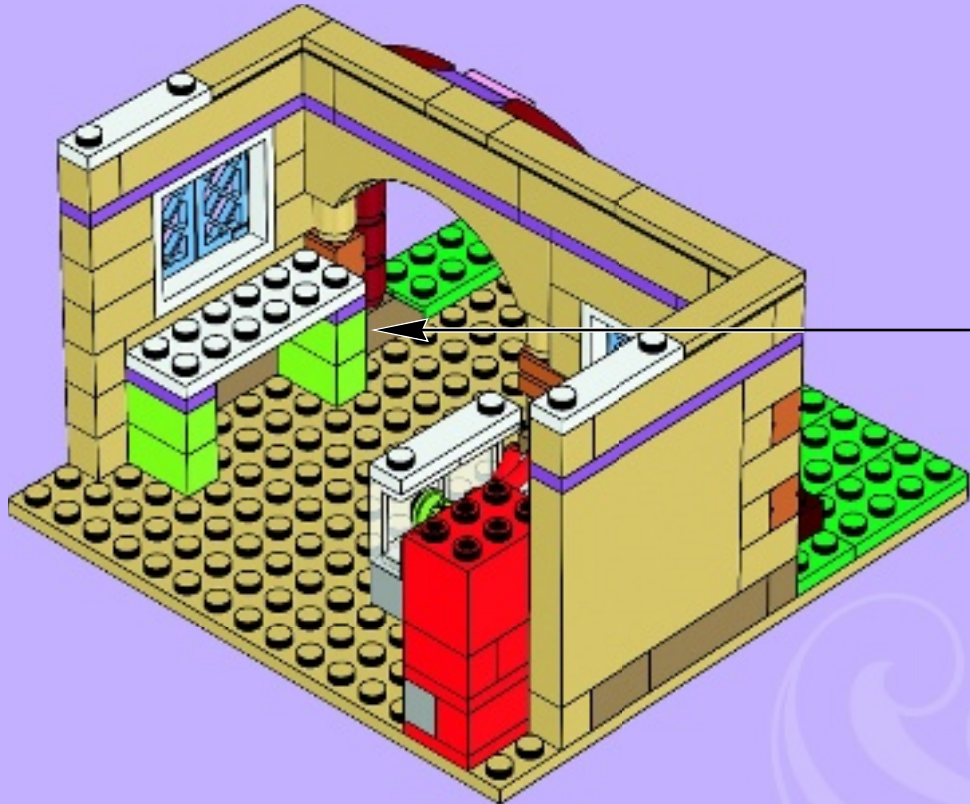
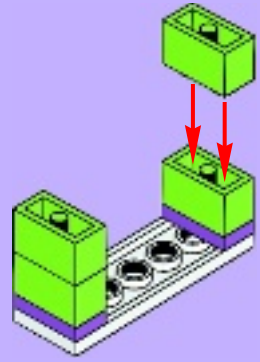

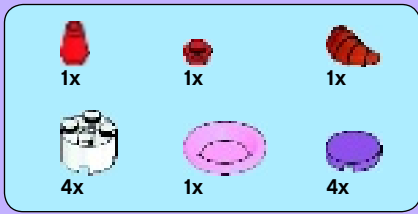

25

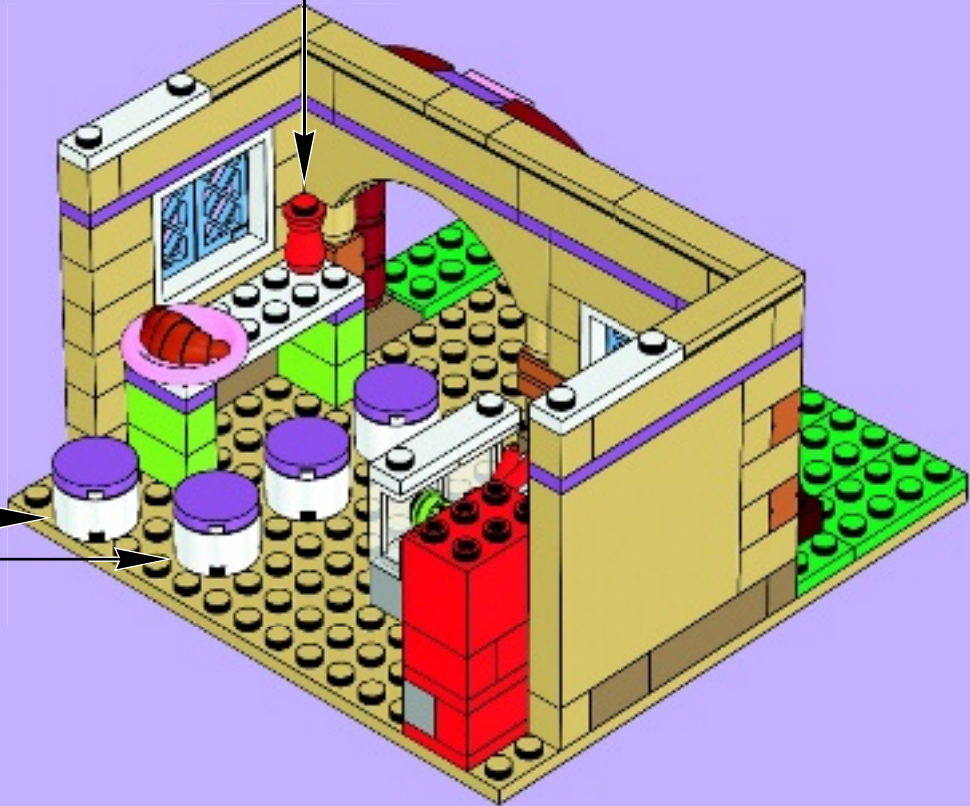
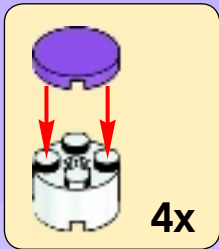
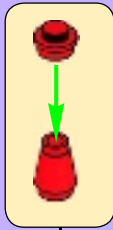

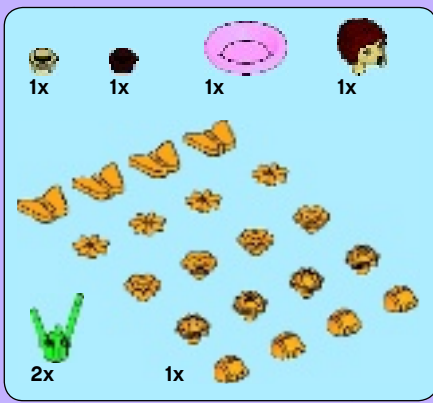

26

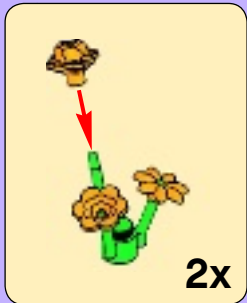
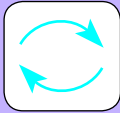



Friends



LEGOFriends.com