



STAR WARS

TM



7961





2x

48

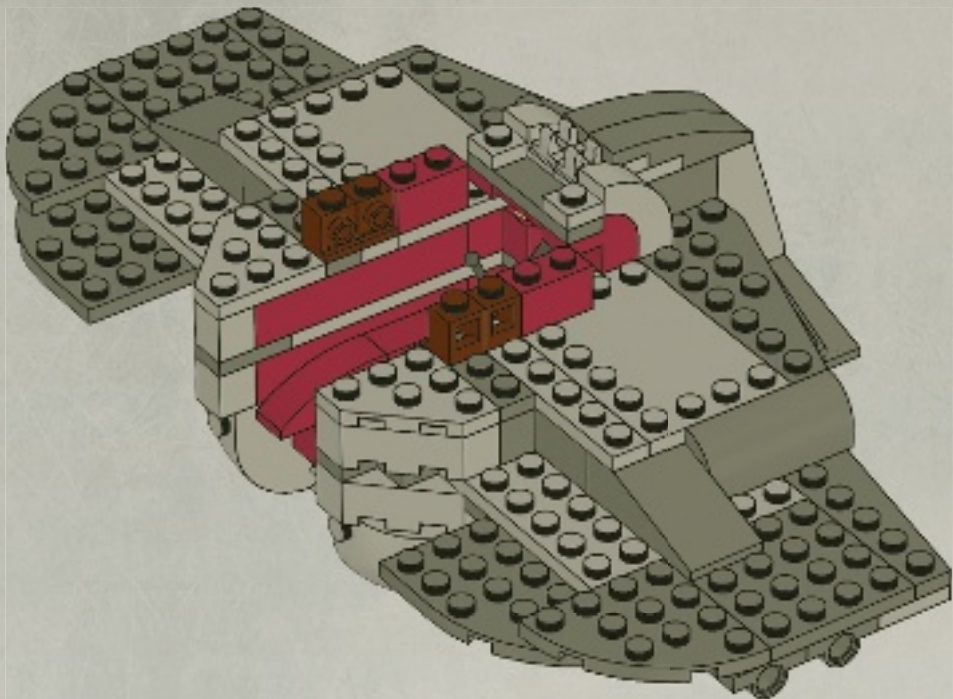

2x



2x

49

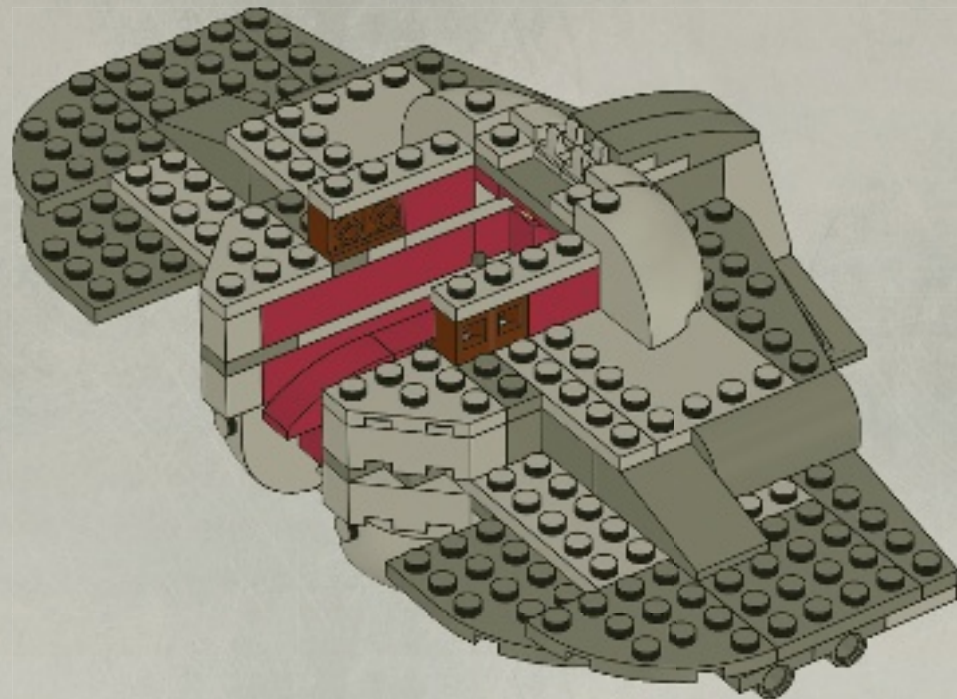



2x

50

1



2



2x

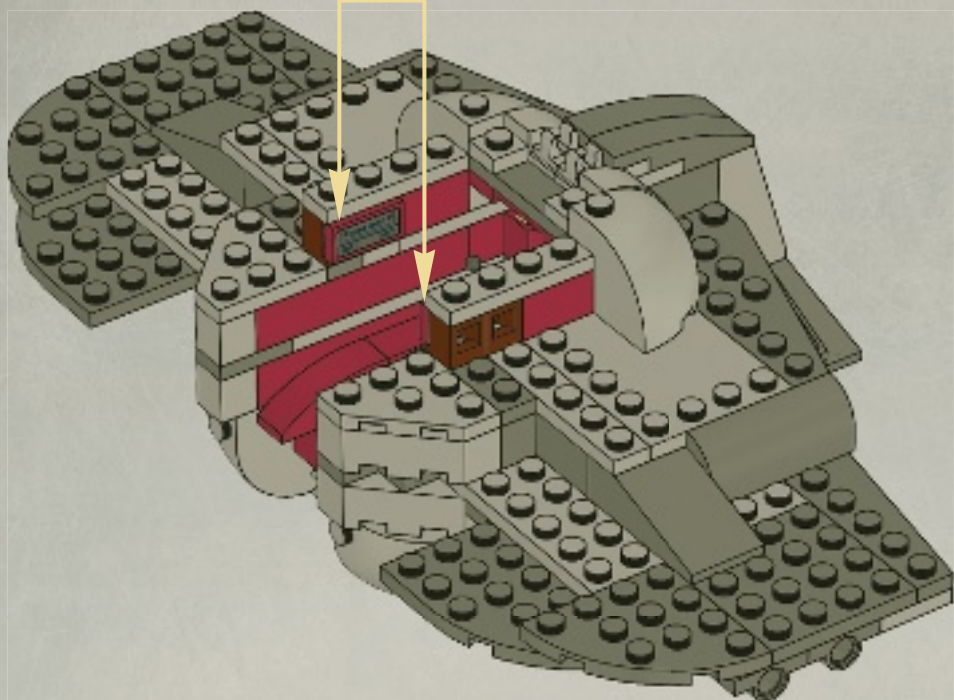

2x

51

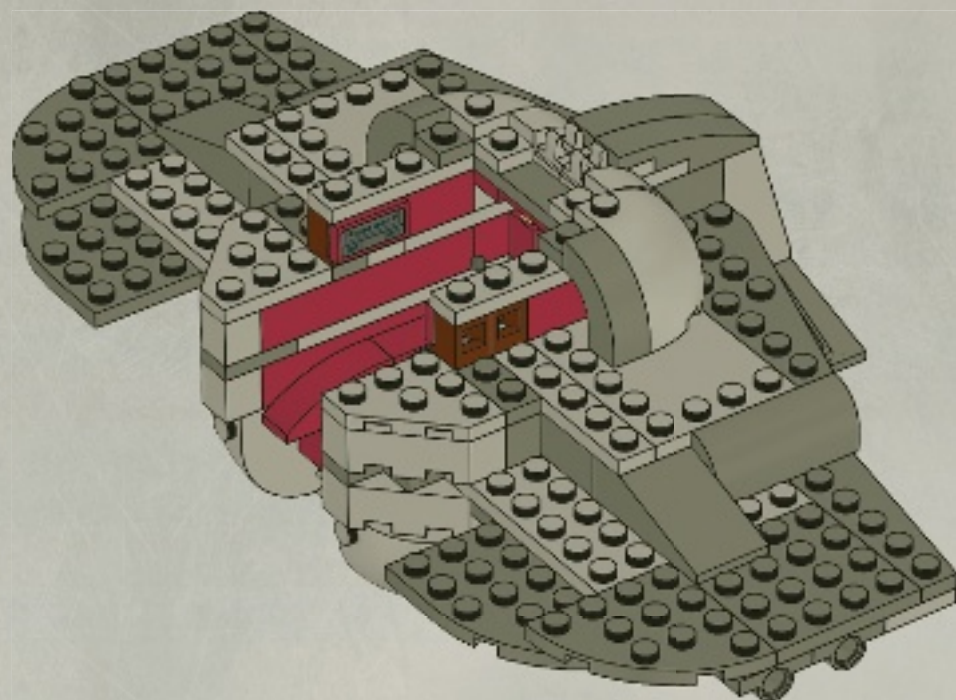



2x



1:1

52

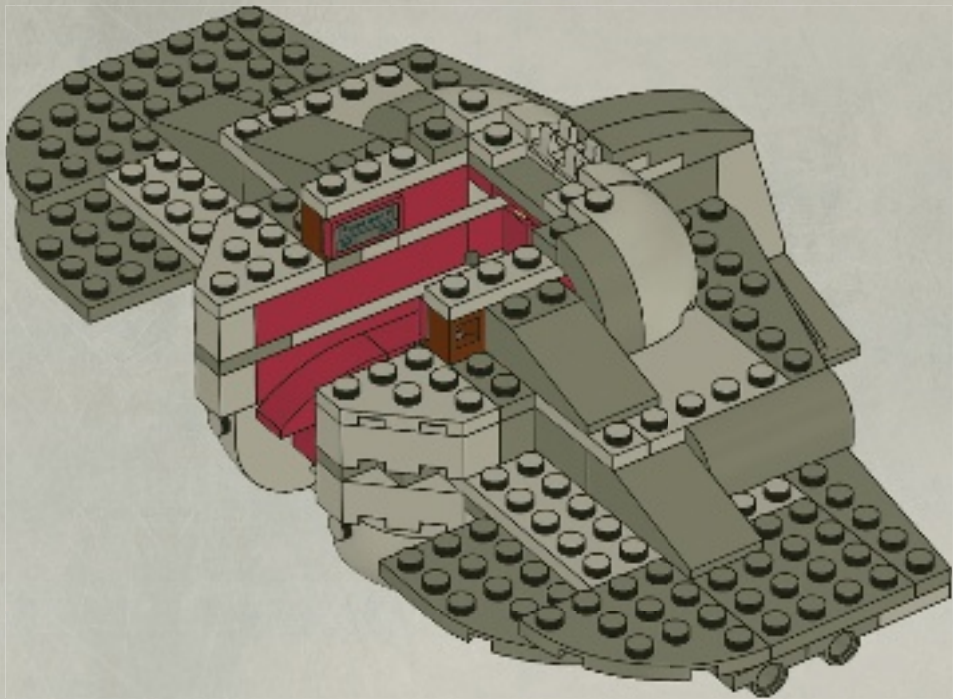

2x

53

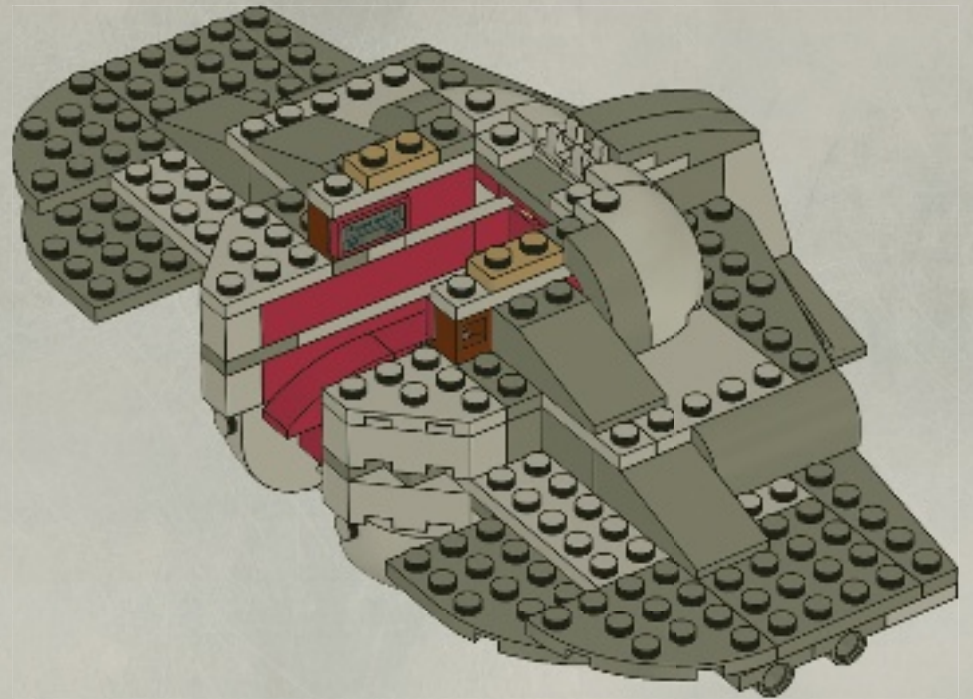



4x

54

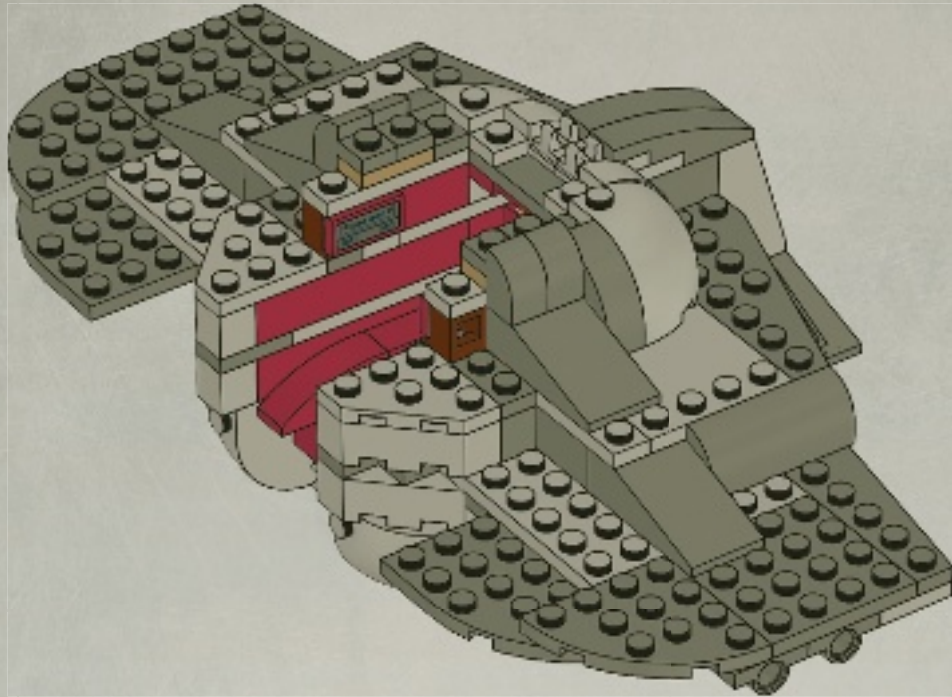

2x

55

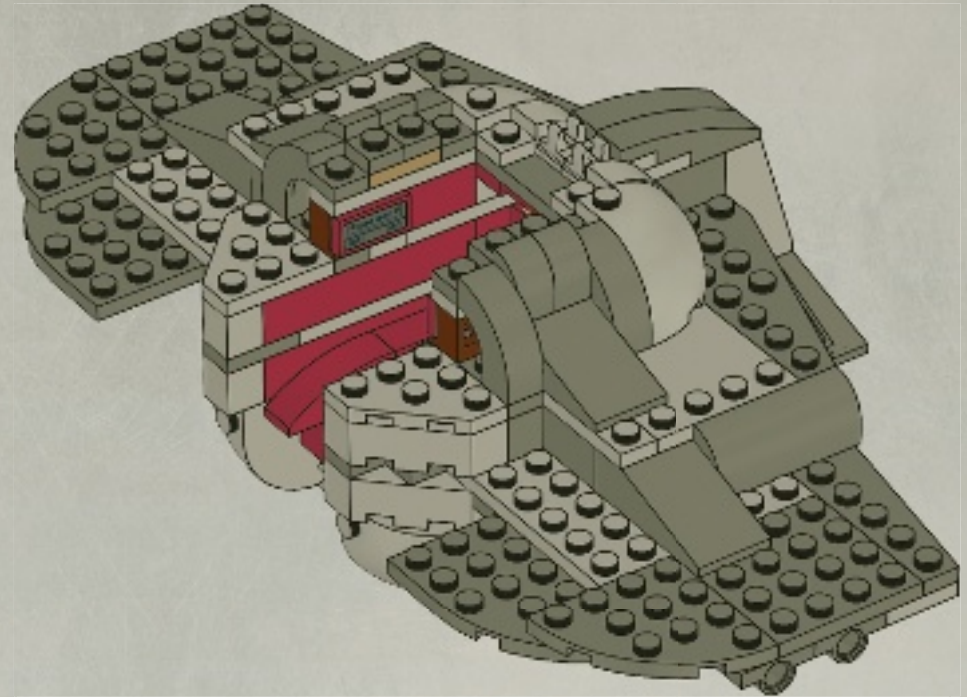



4x

56

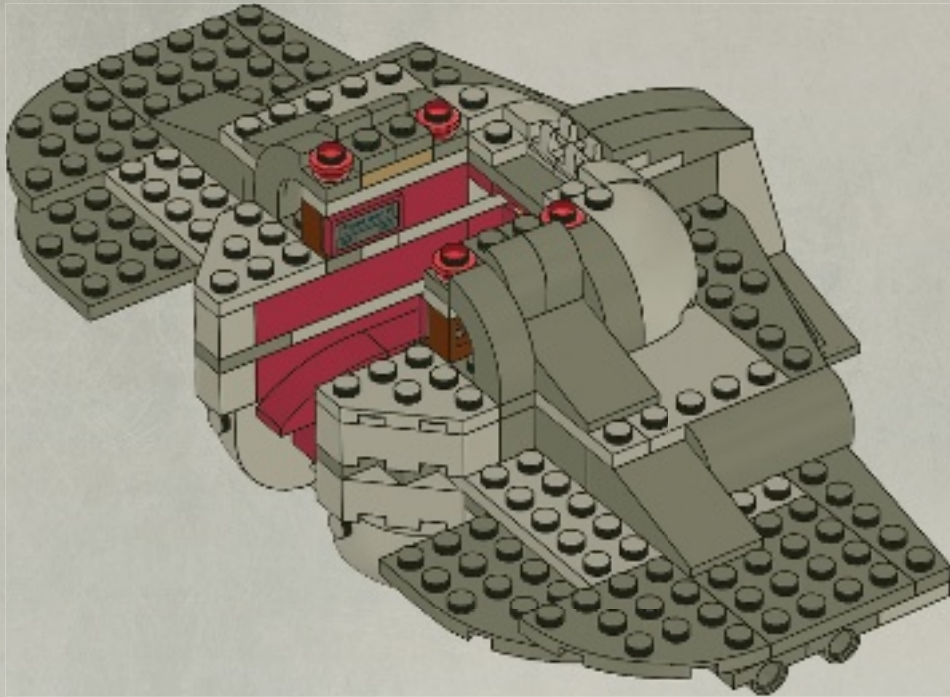

2x

57

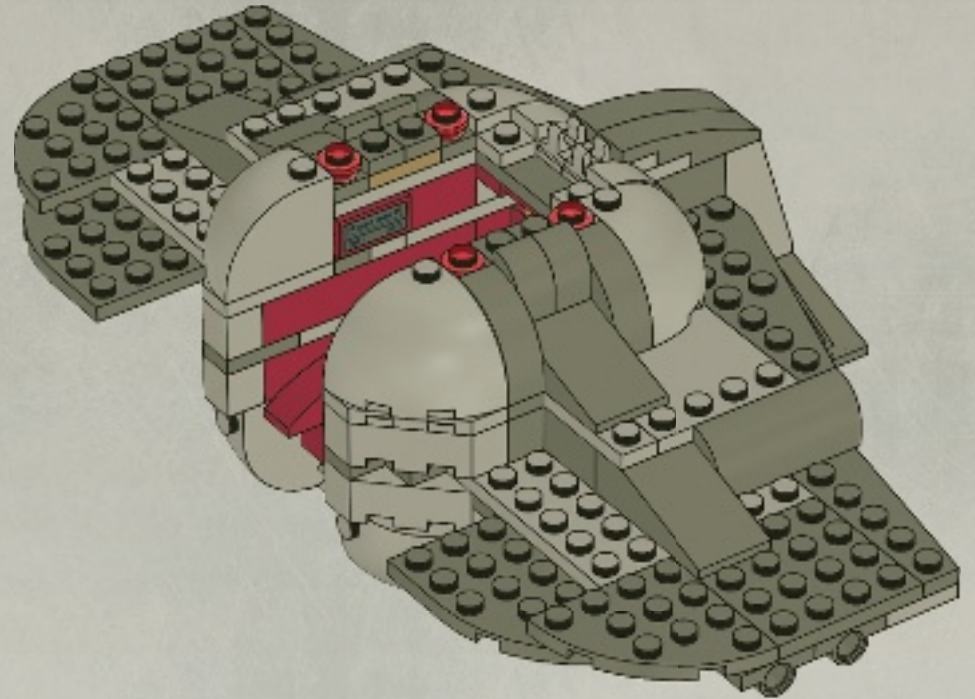



2x

58

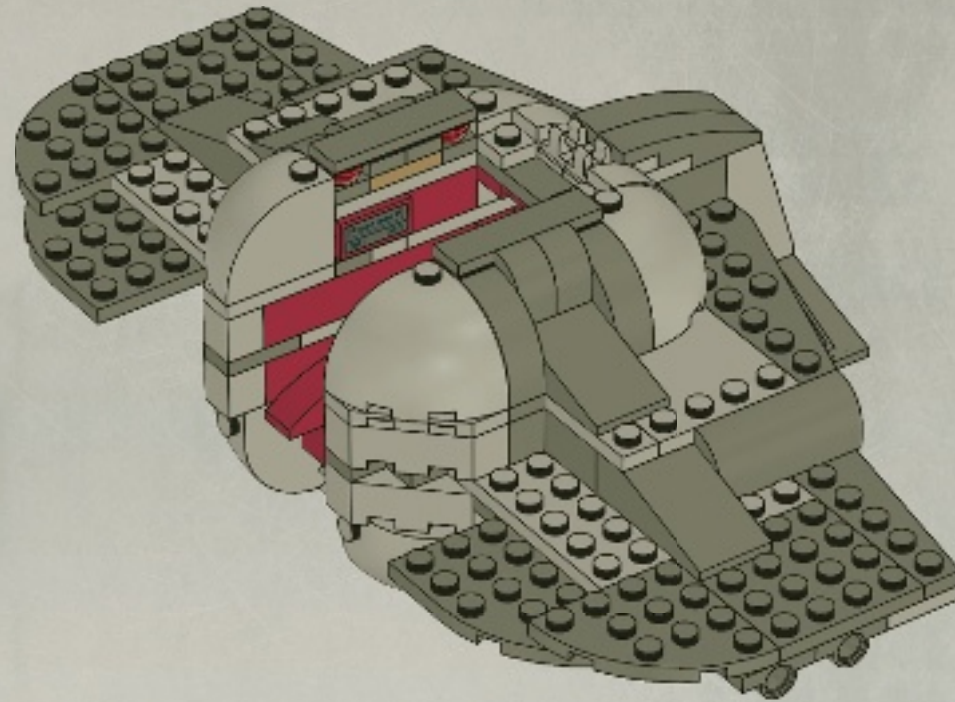

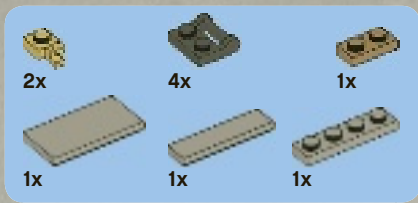

59

1. Two dark grey 1x2 Technic connectors are joined together.
2. A dark grey 1x2 Technic connector is added to the top of the assembly.
3. A gold pin is inserted into the top hole of the assembly.
4. A grey 1x4 Technic beam is attached to the bottom of the assembly.

1. A grey 1x4 Technic beam with 4 holes is shown.
2. A grey 1x4 Technic beam is shown.
3. A white sticker is placed on the top surface of the grey 1x4 Technic beam with 4 holes.
5. The sub-assembly from step 4 is attached to the top of the grey 1x4 Technic beam with 4 holes.

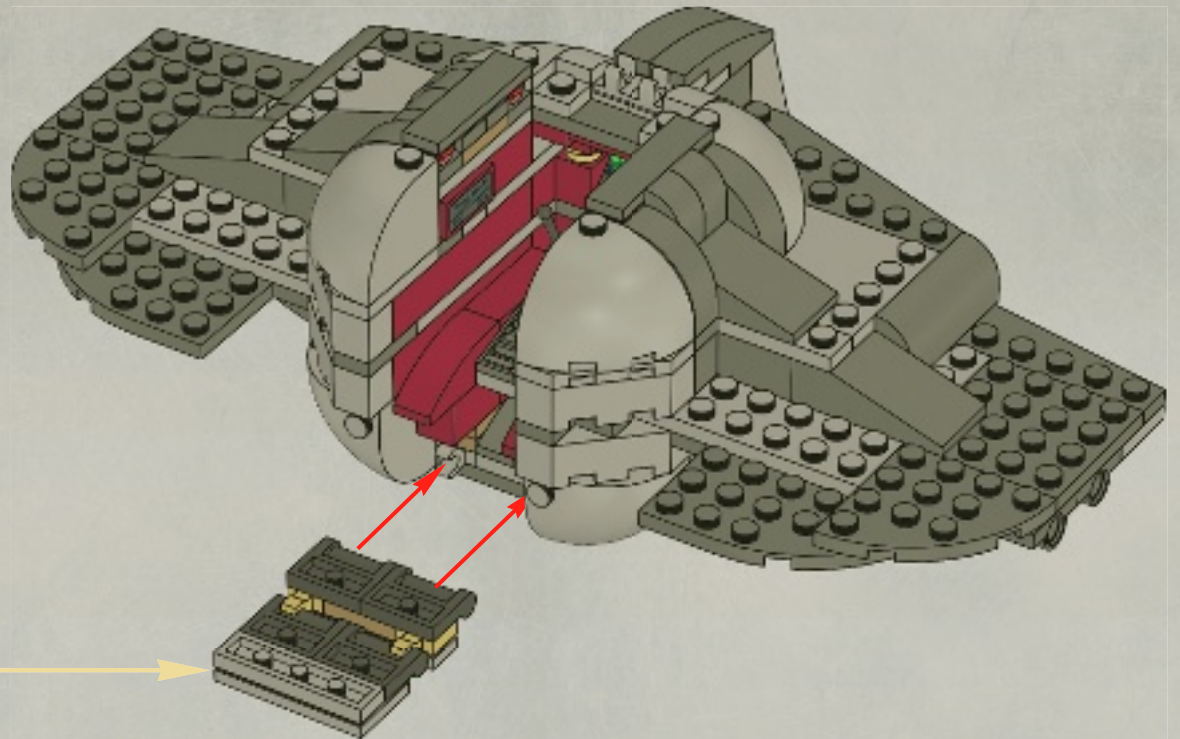



2x

60

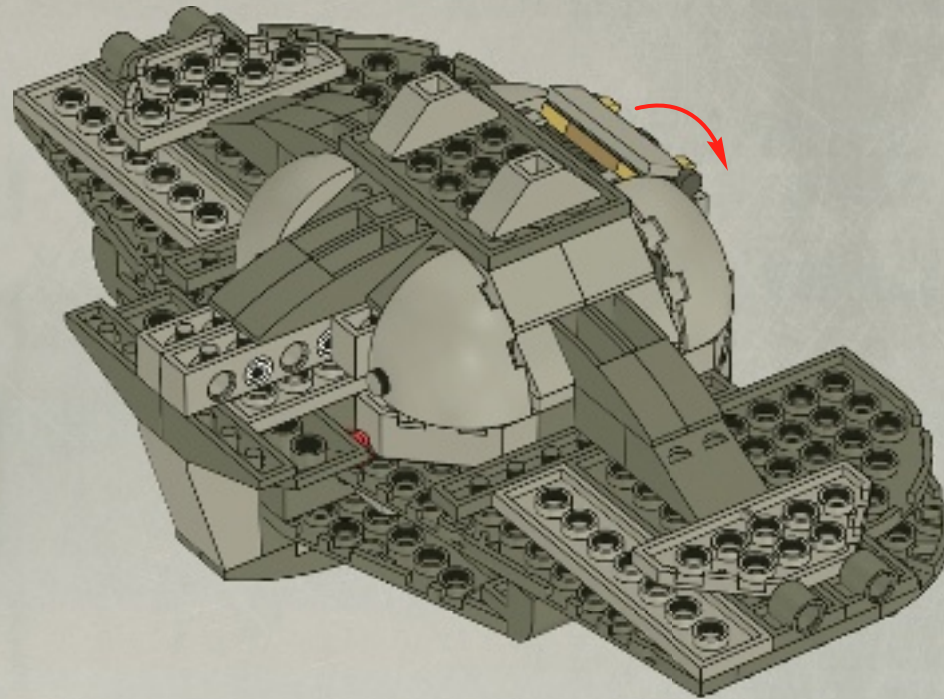

61

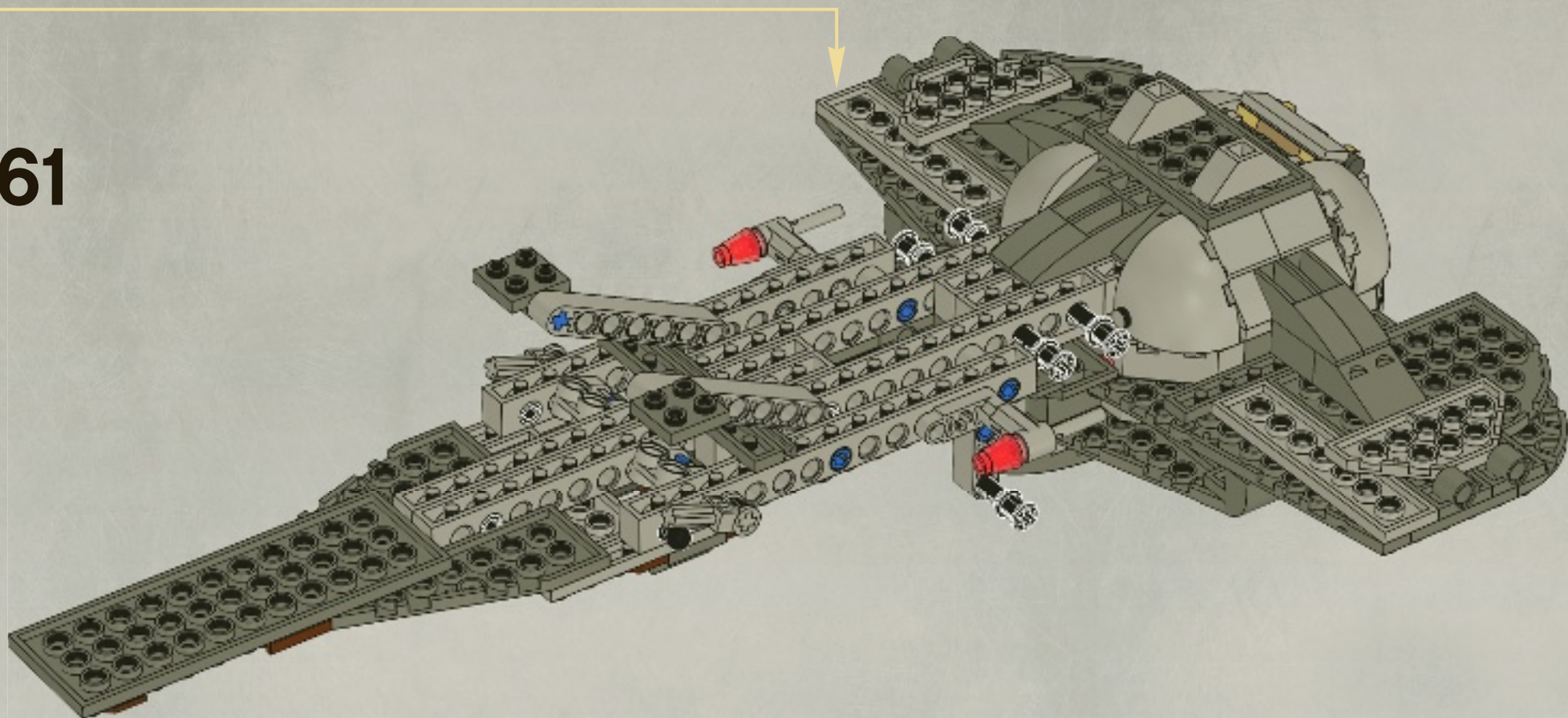

62

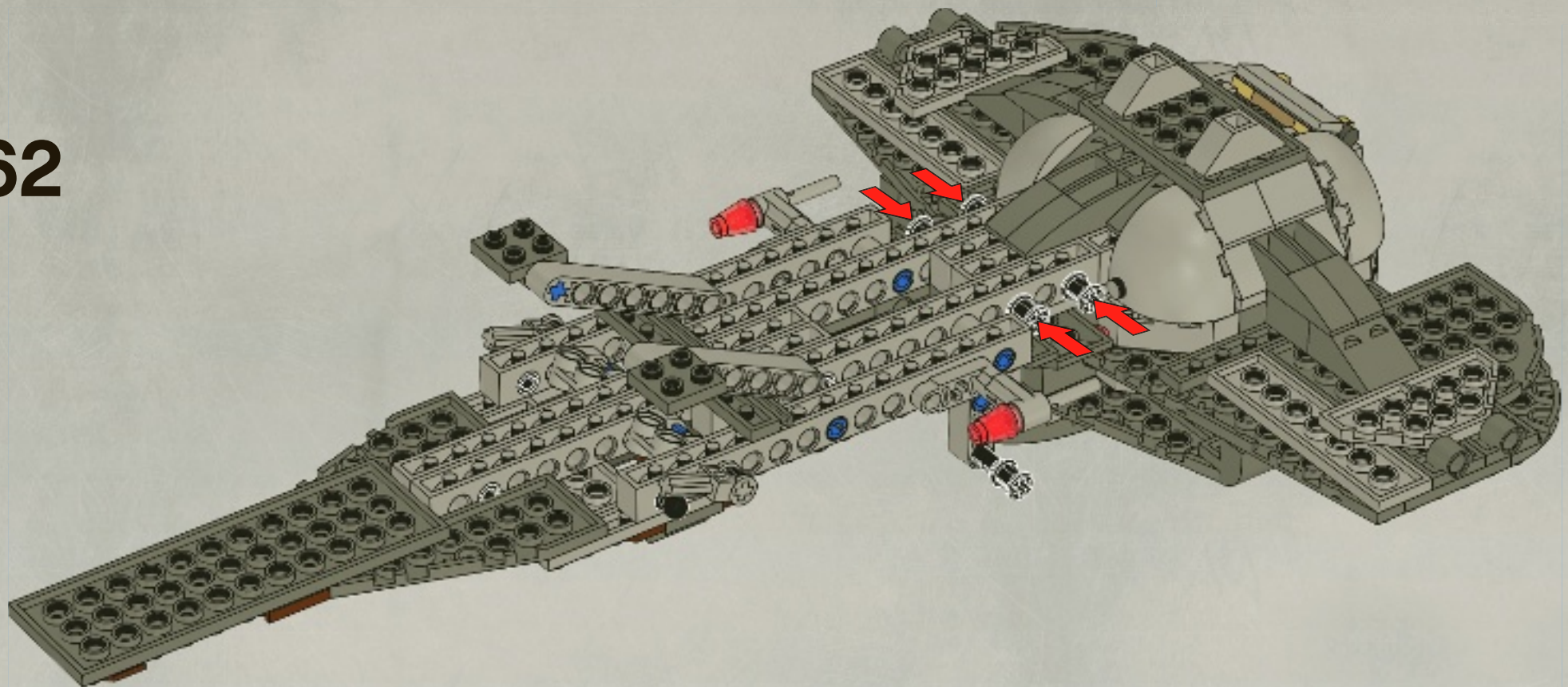



63

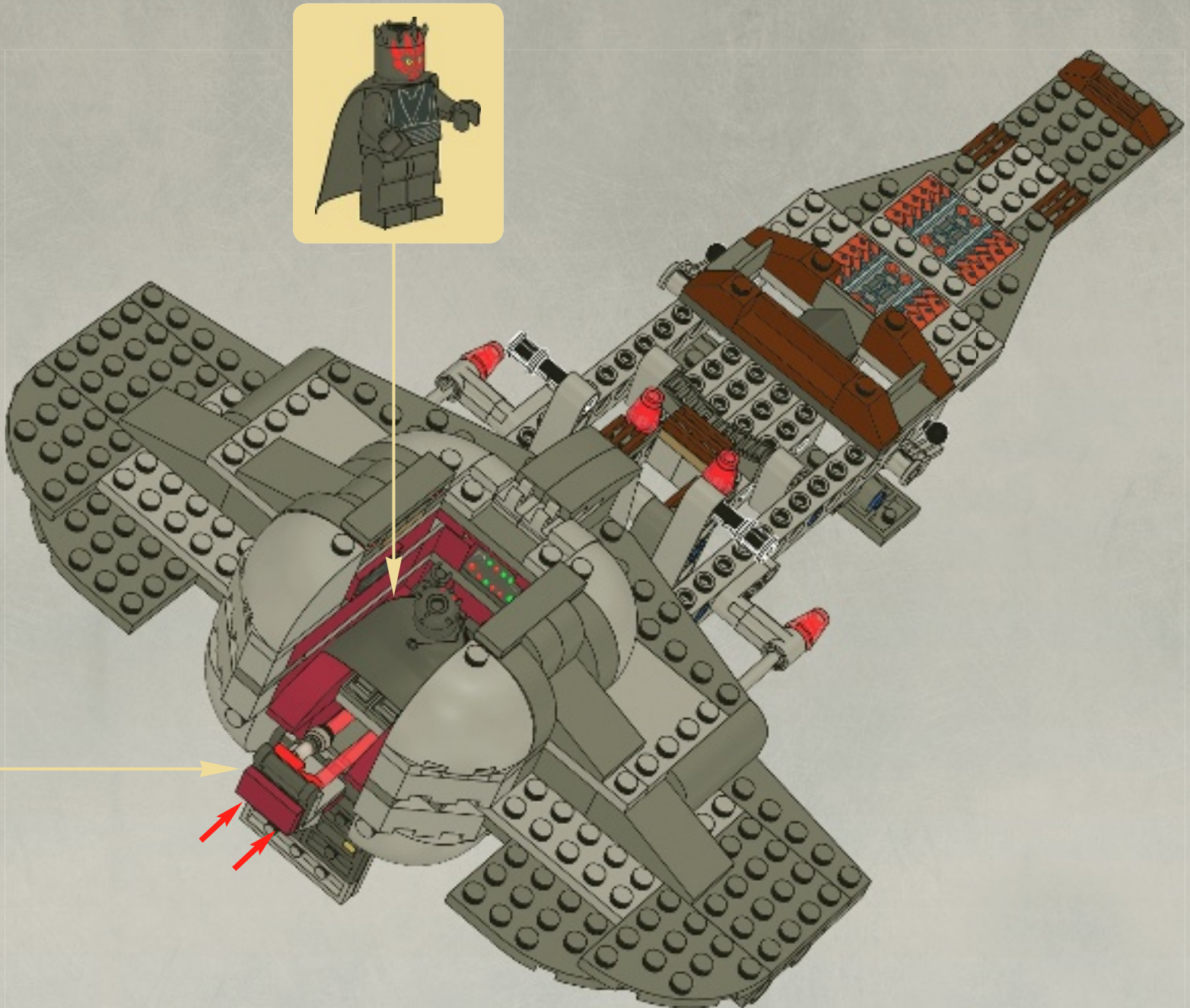

64

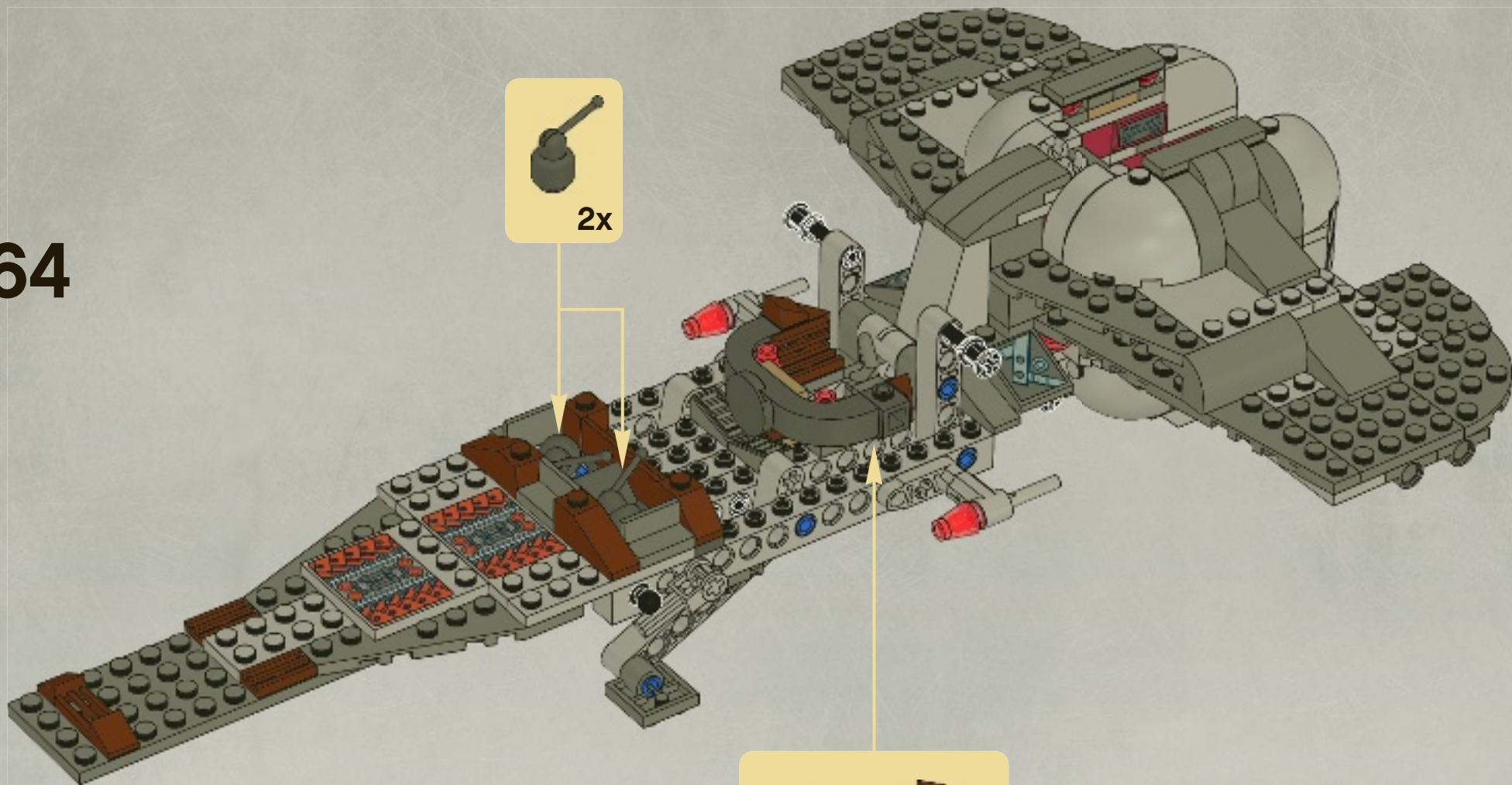



1x

1

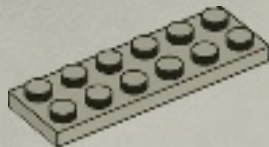

1x



2x

2

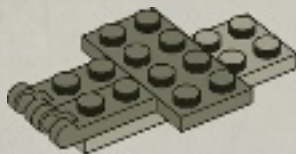

2x

3

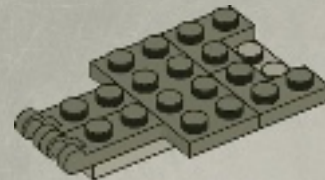

1x

4

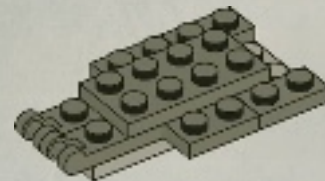



2x

5

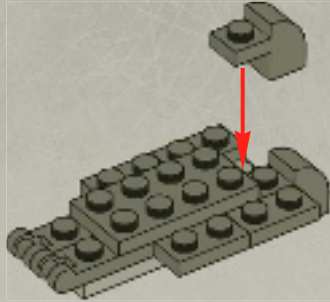

1x

6

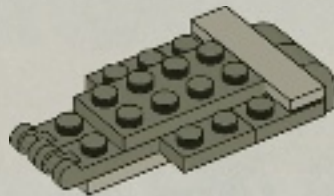

2x

7

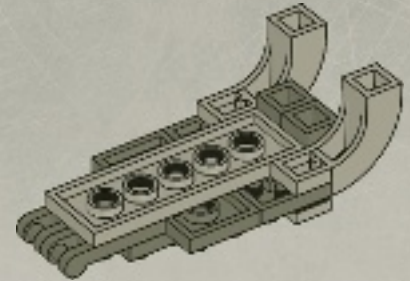

2x

8

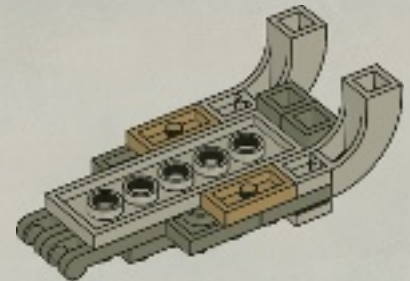



1x

9

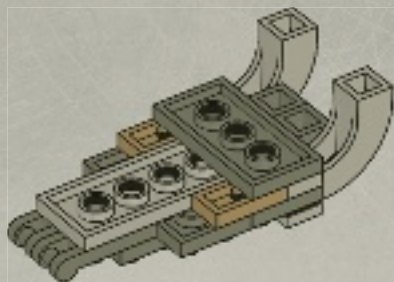

2x

10

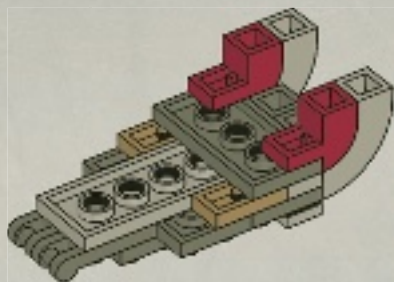

1x

11

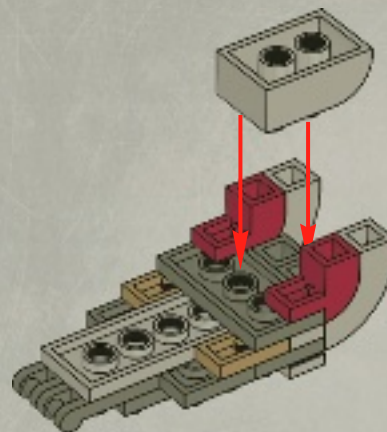

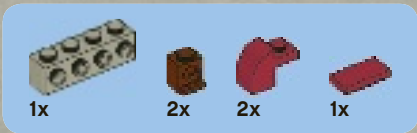

12

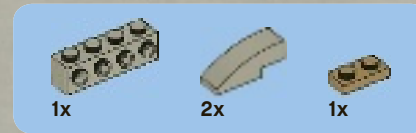
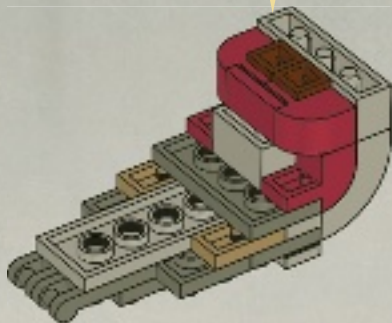
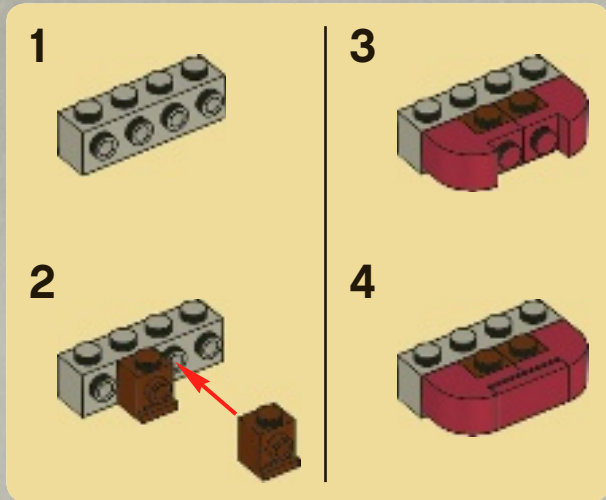

13

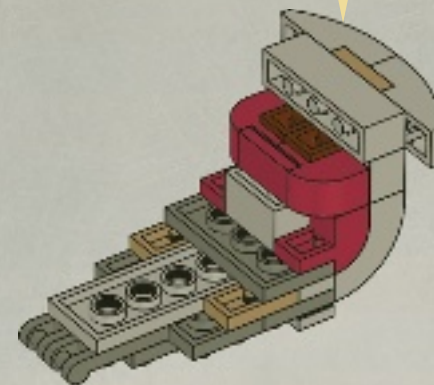
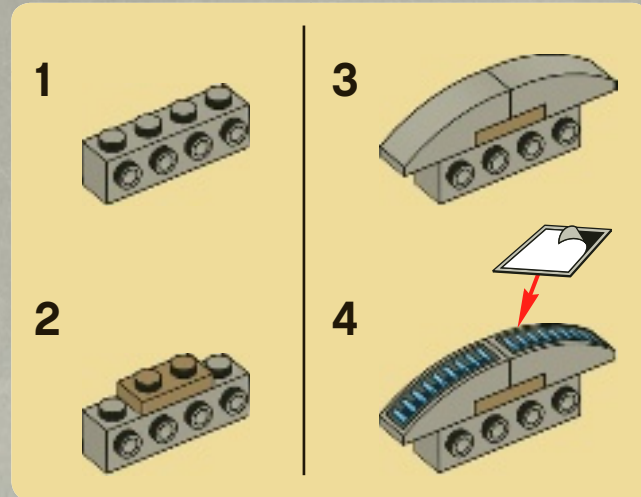



1x



1x

14

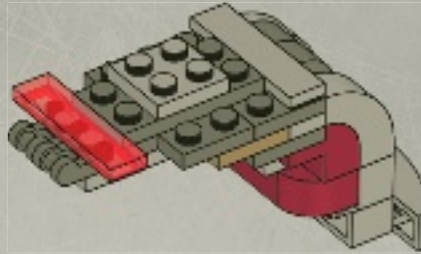

1x

15



65

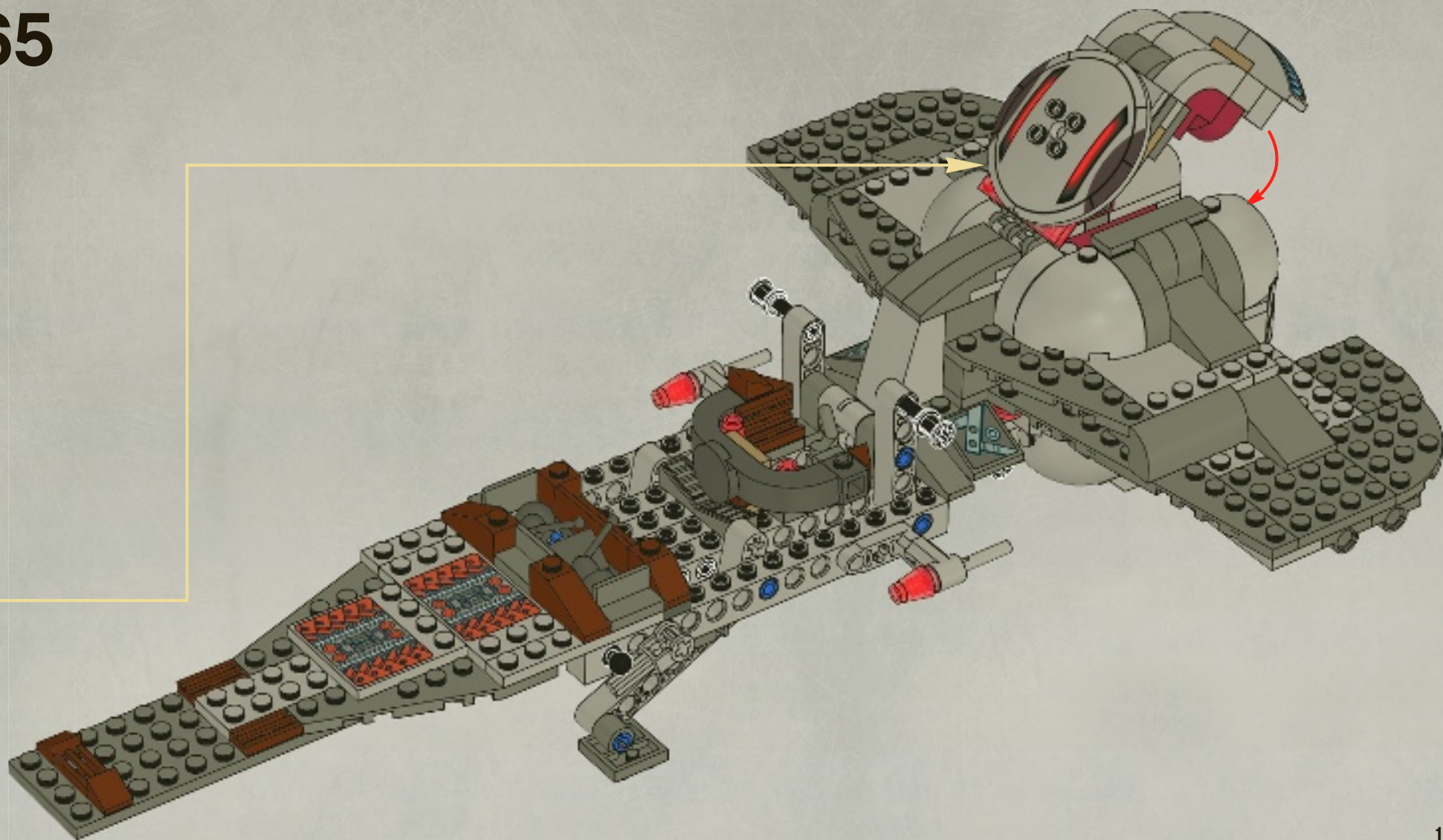

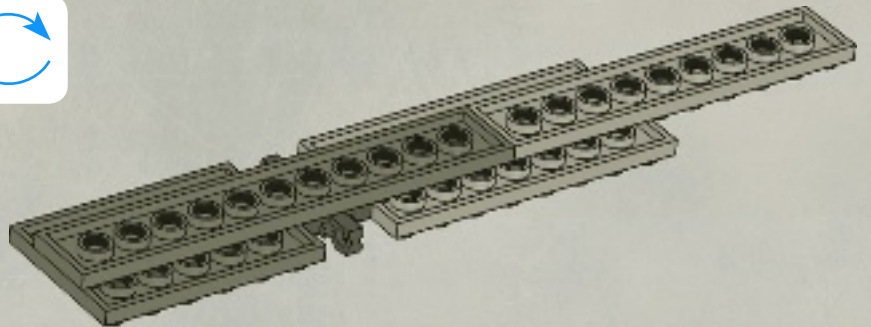
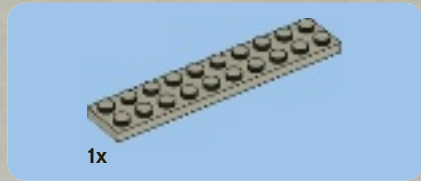
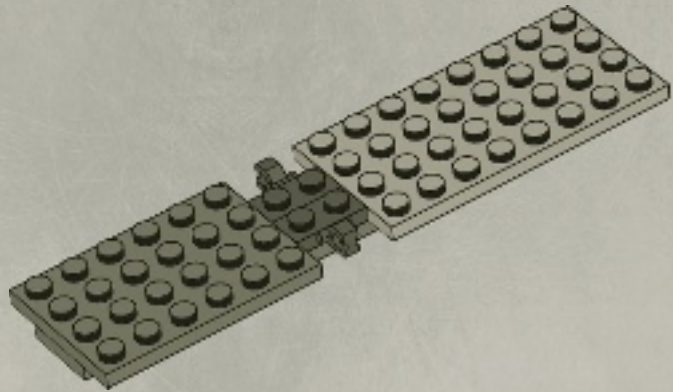
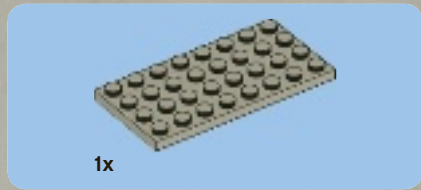
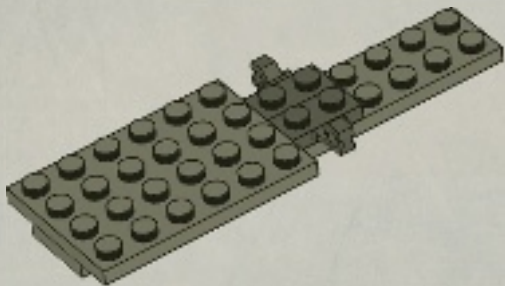
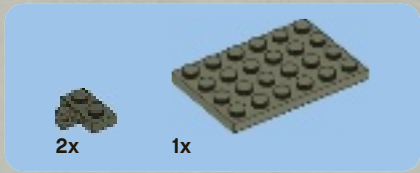
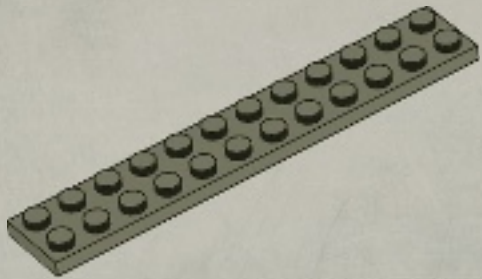
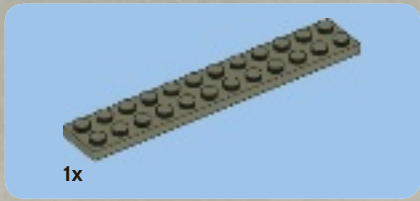
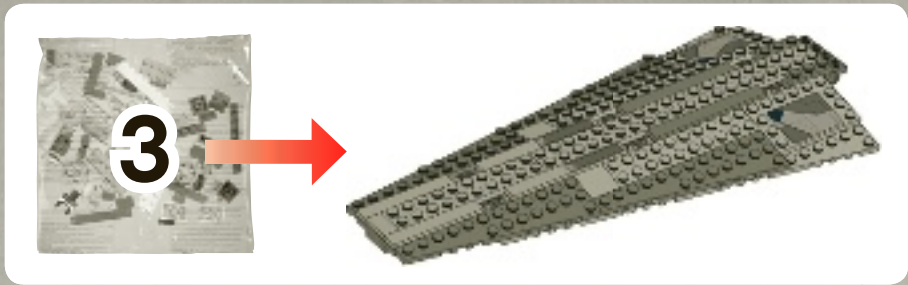

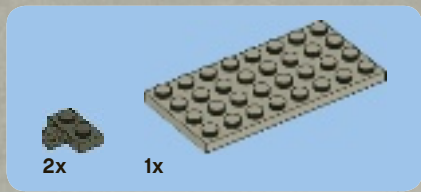

5

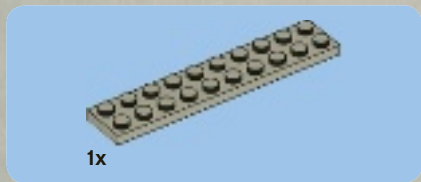
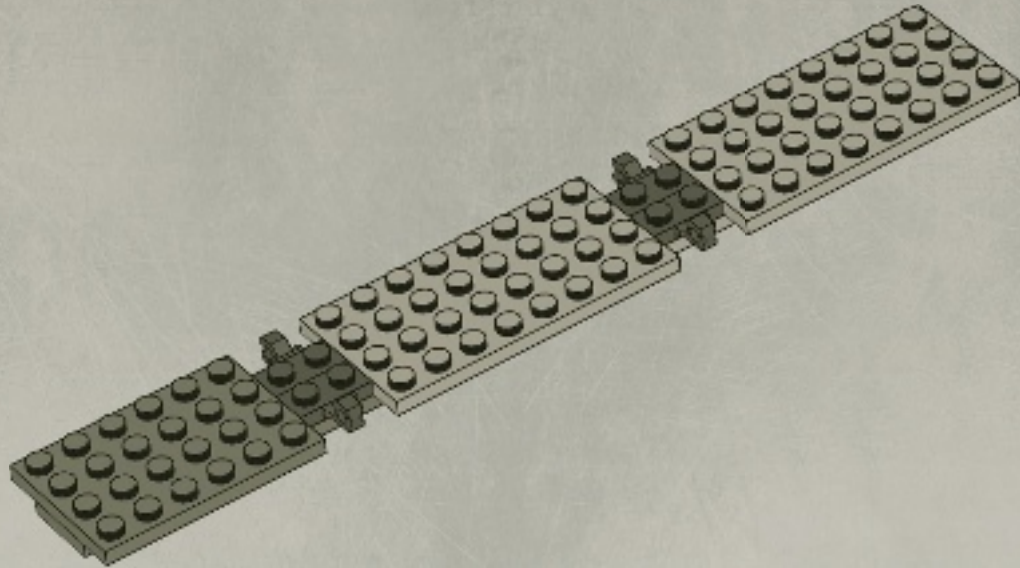

6

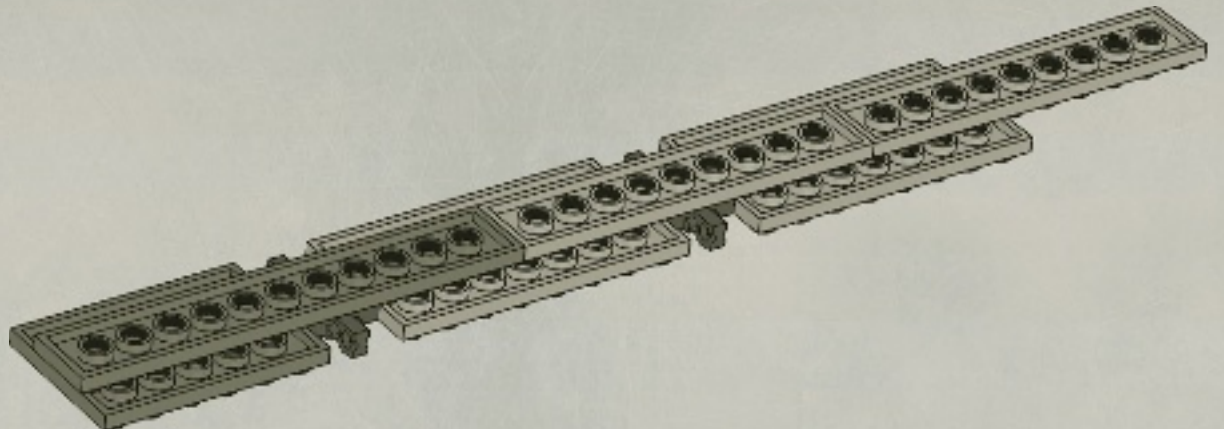



7

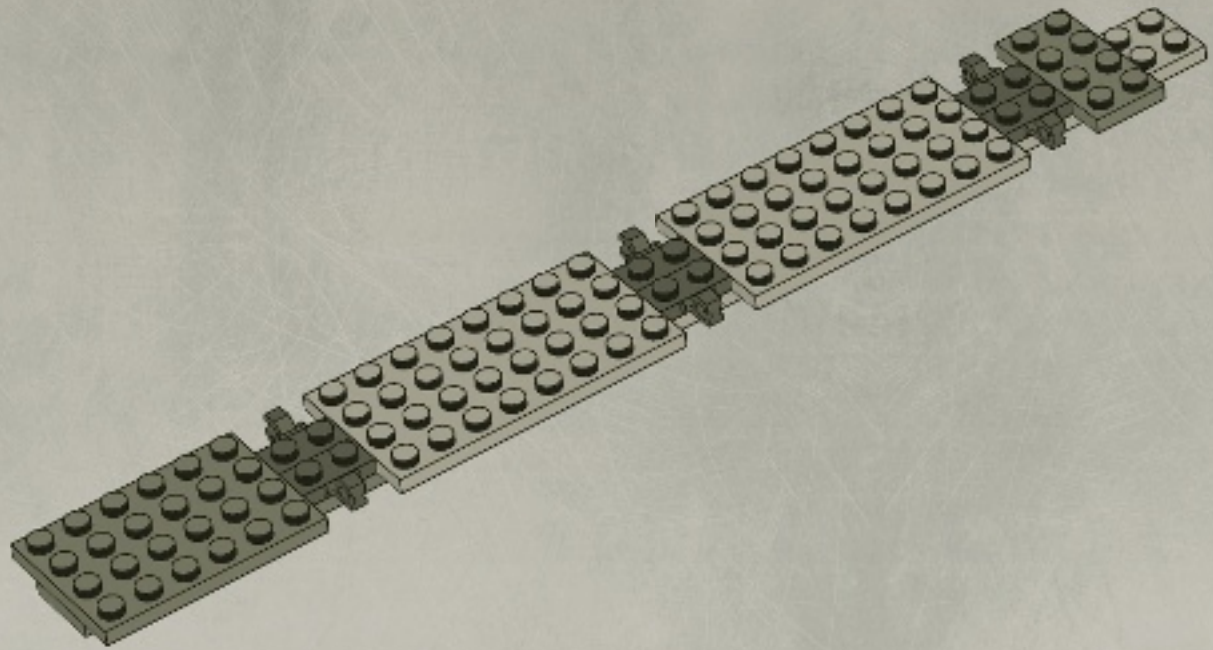

8

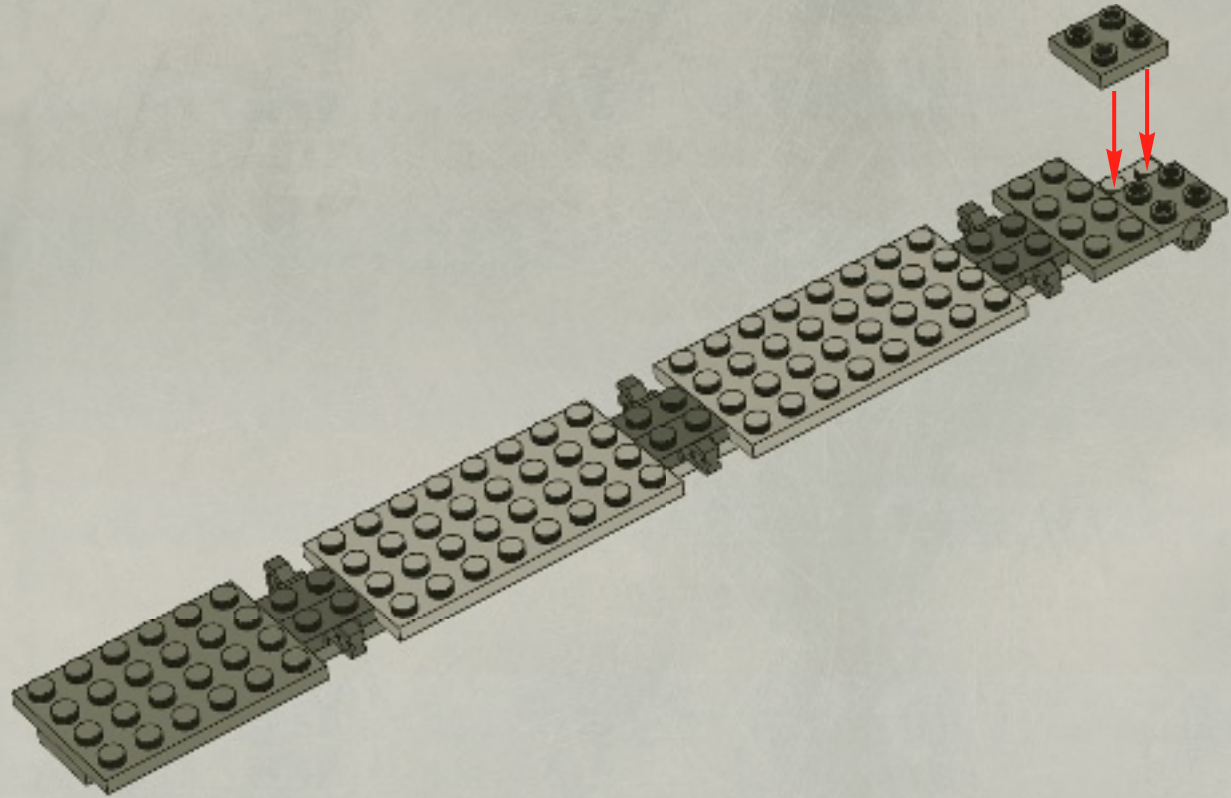

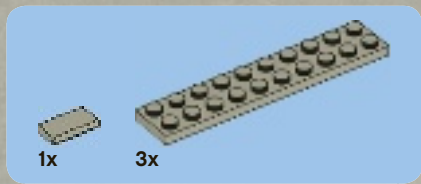

9

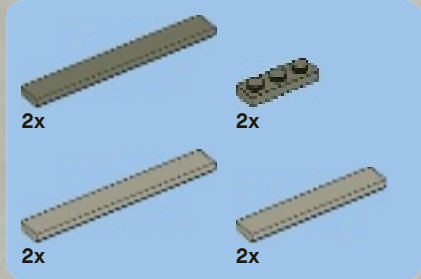
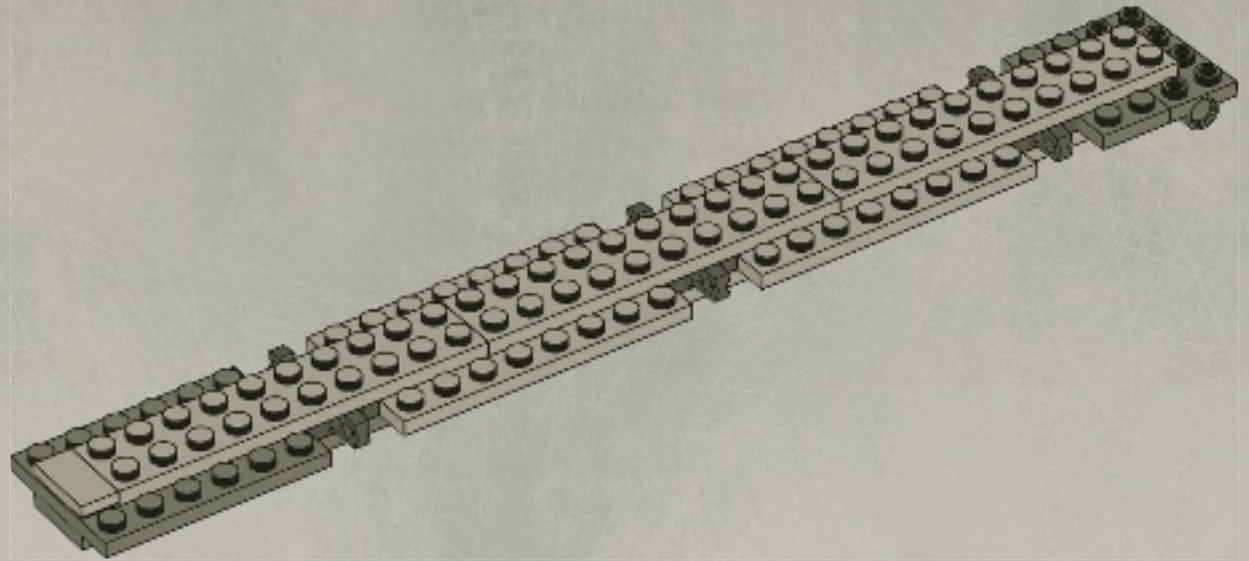

10

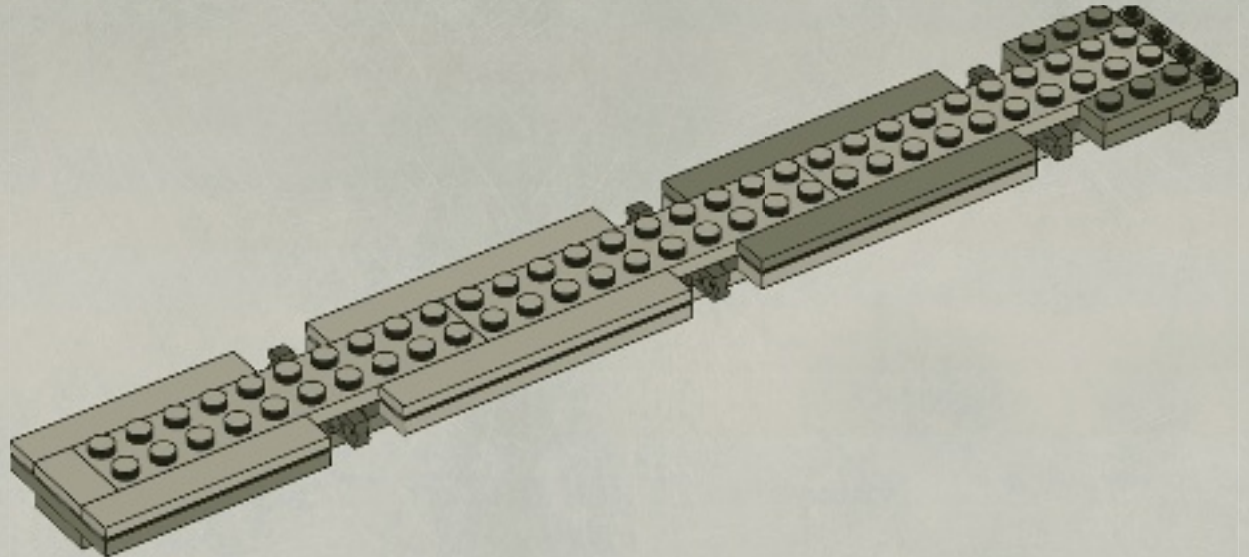



2x

11

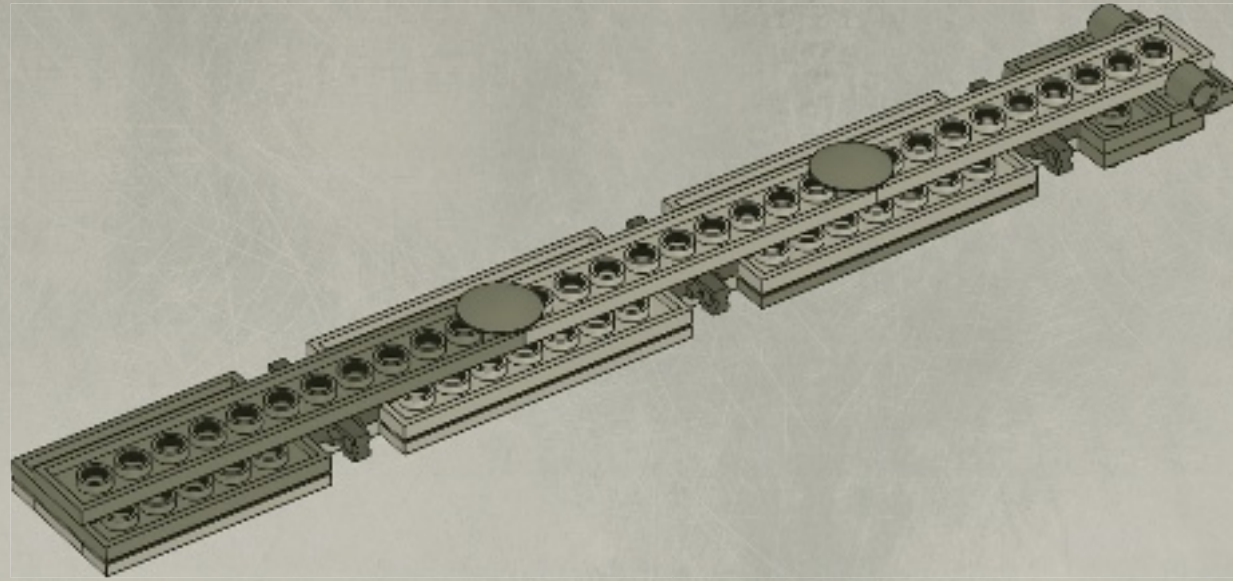

12

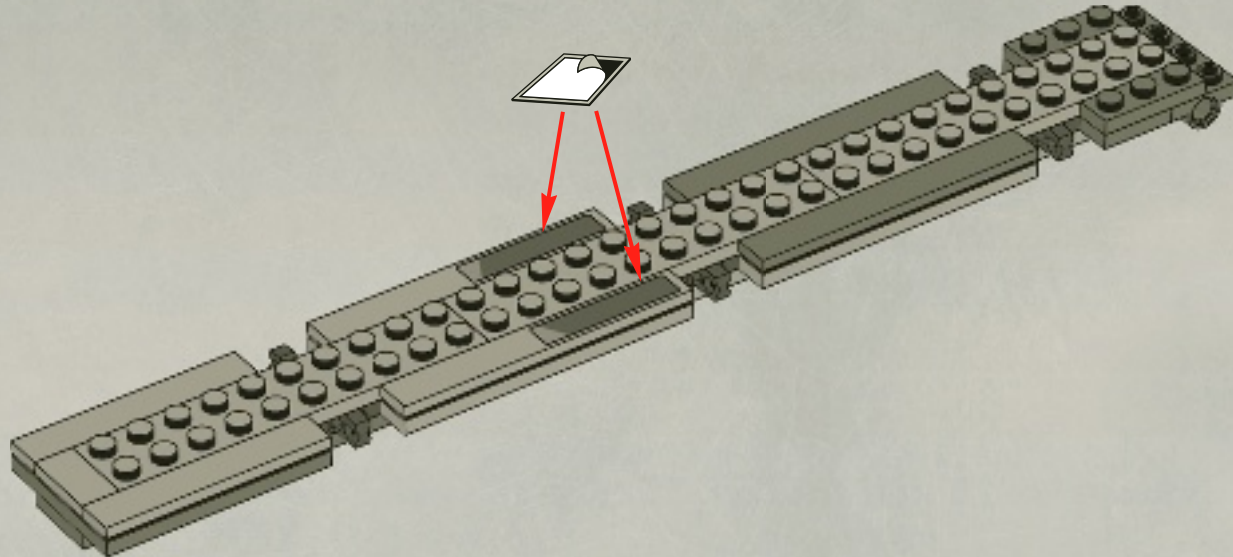

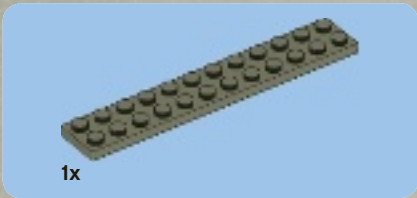
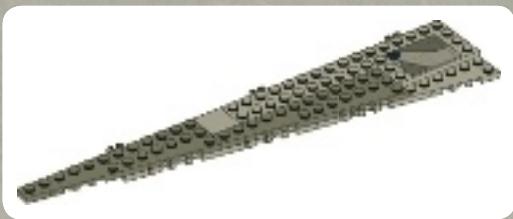

1

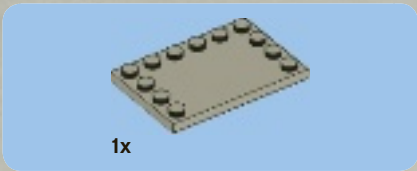
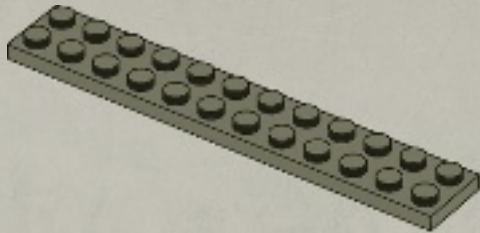

2

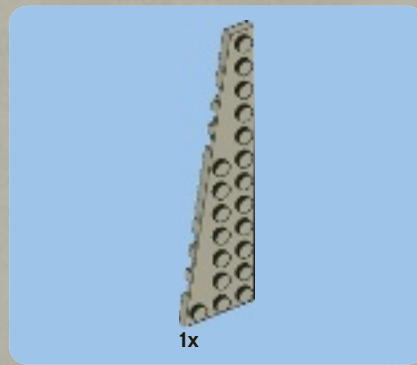
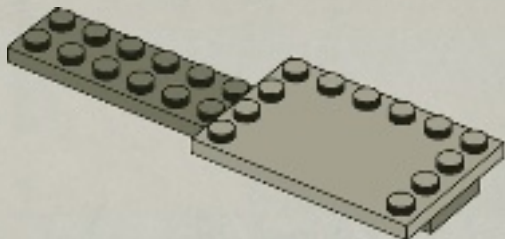

3

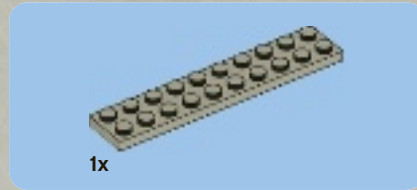
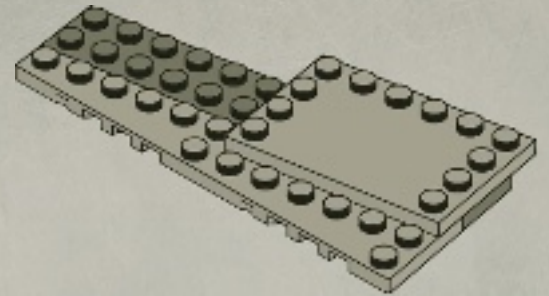

4

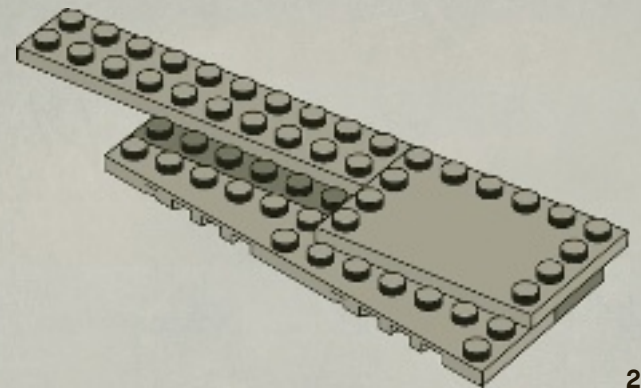

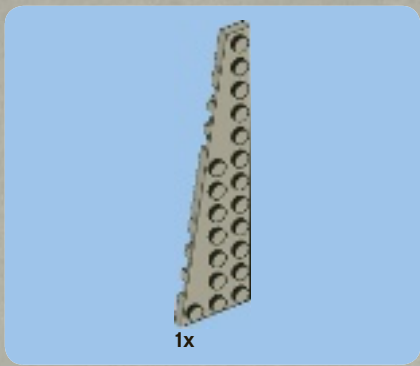

5

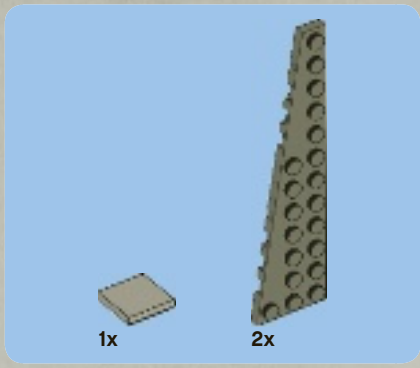
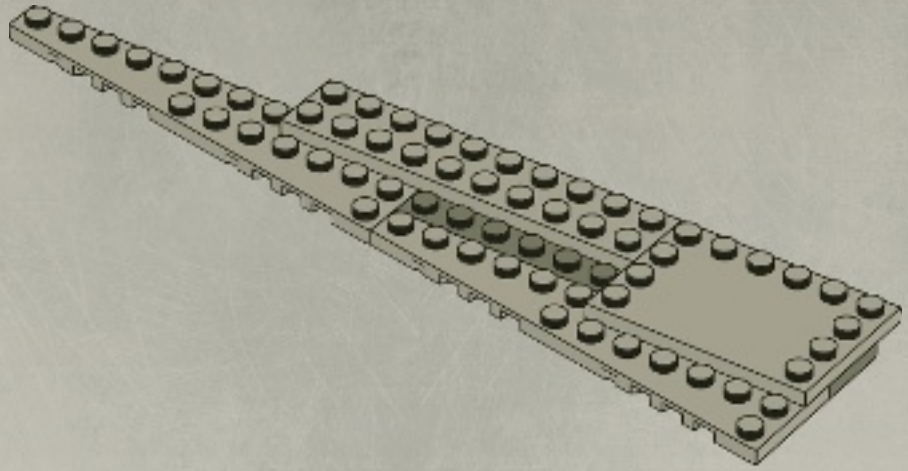

6

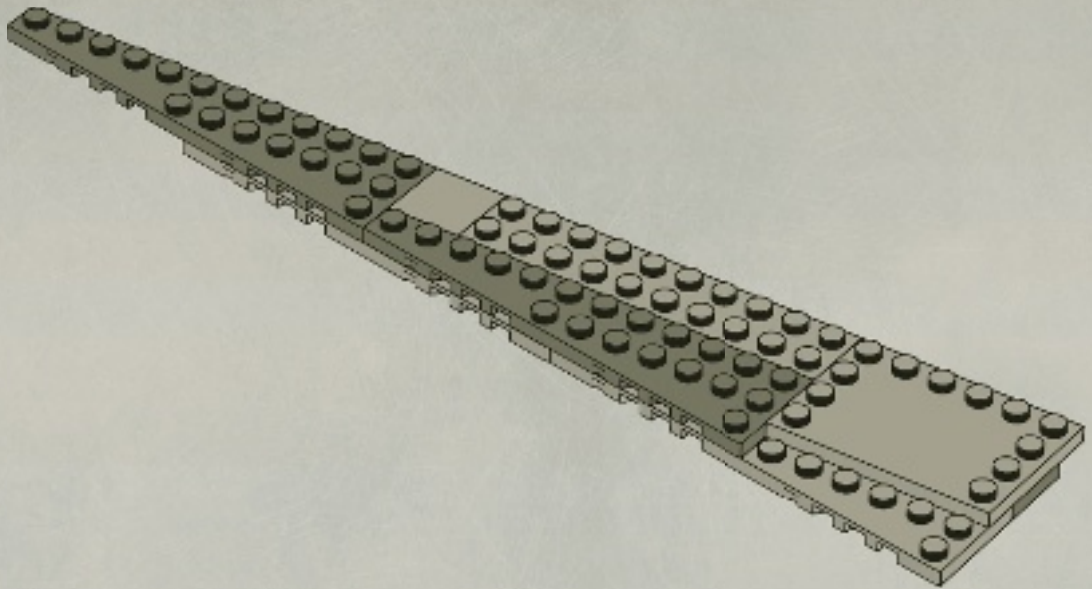



3x

7

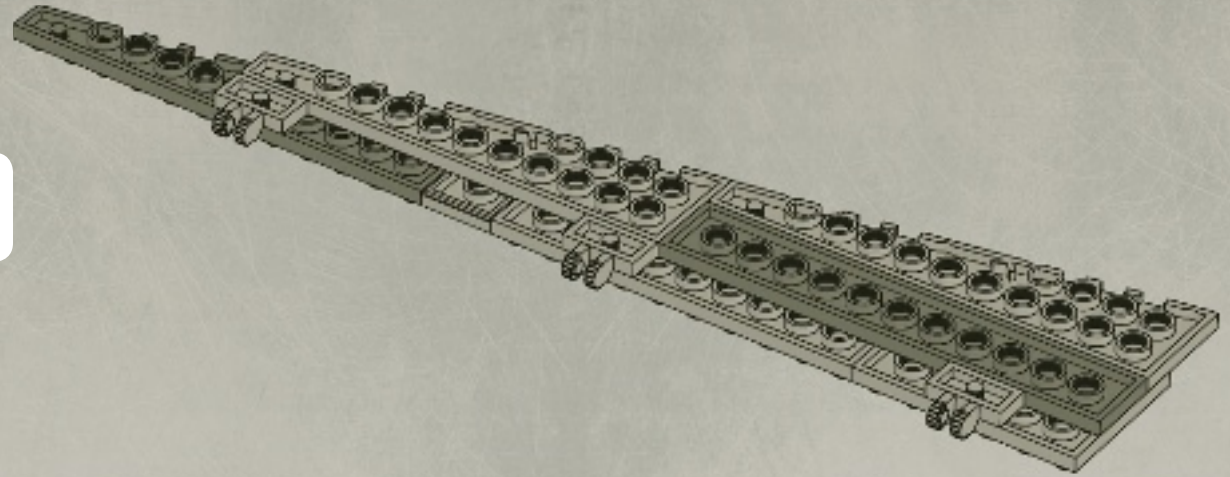

3x

8

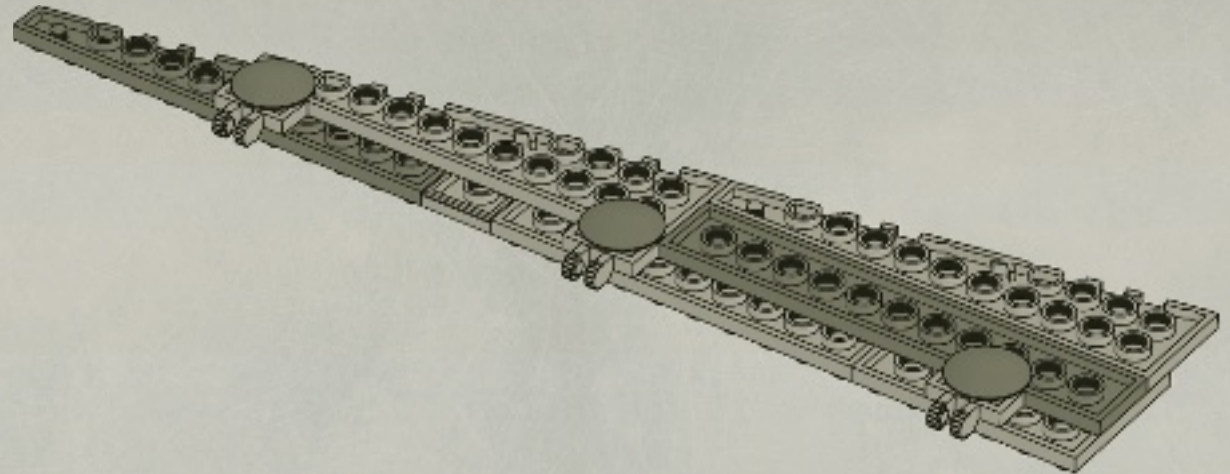

9

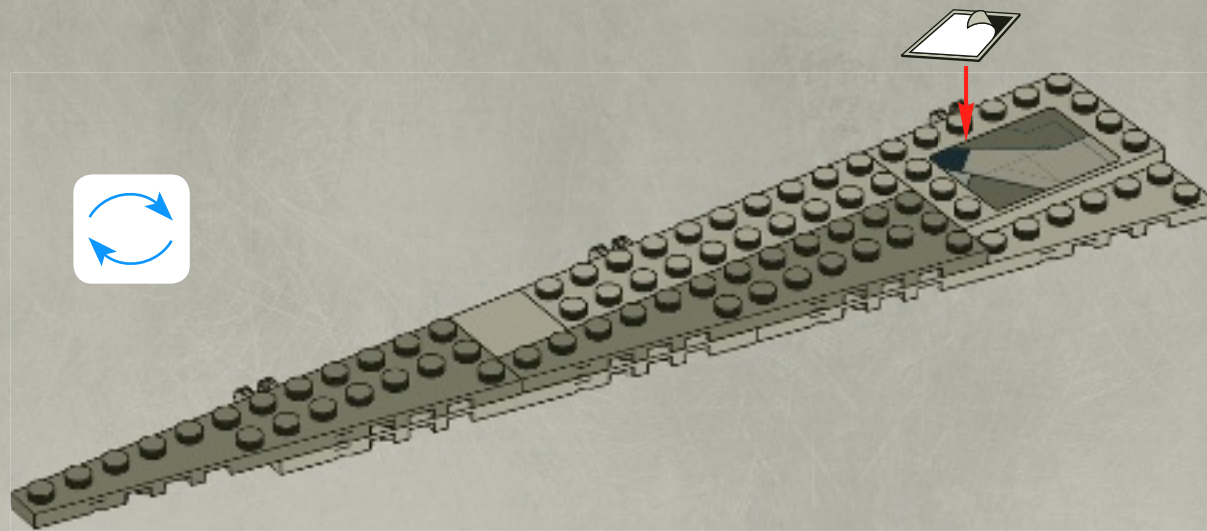

12

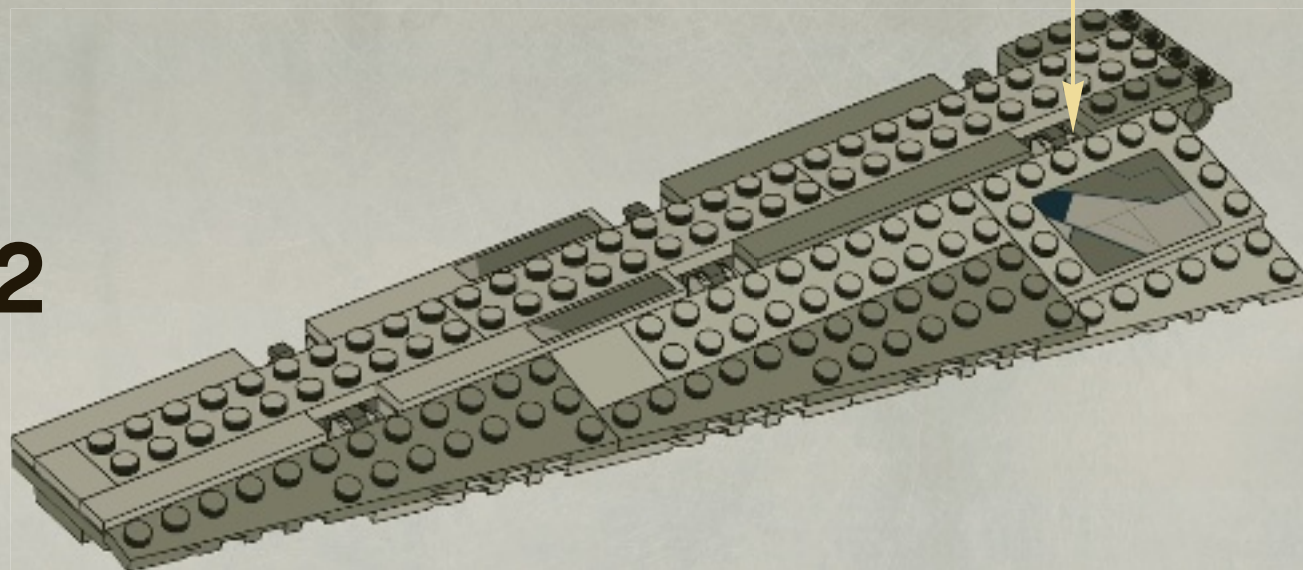

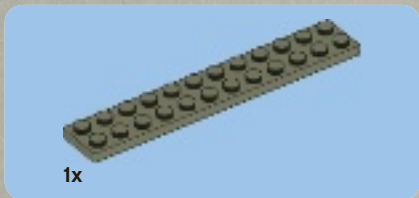

1

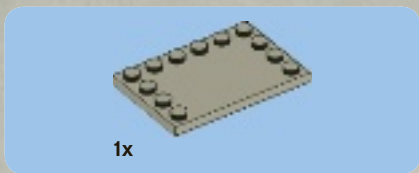
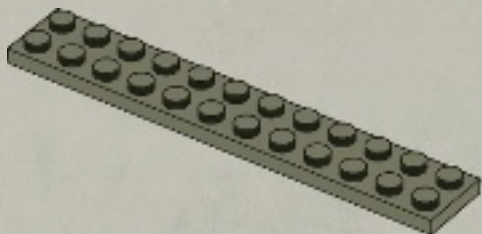

2

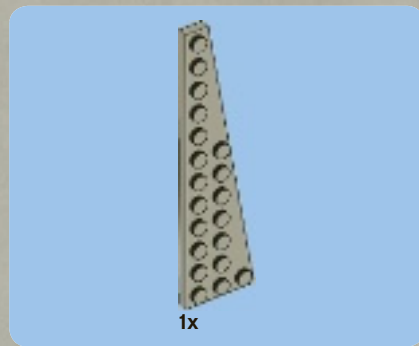
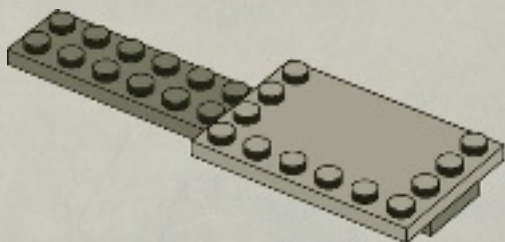

3

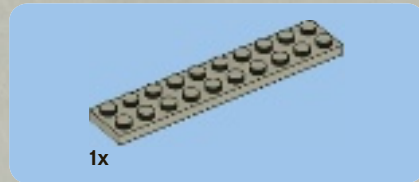
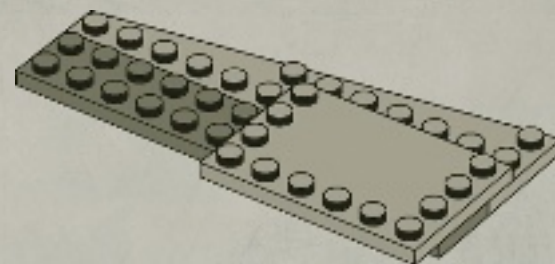

4

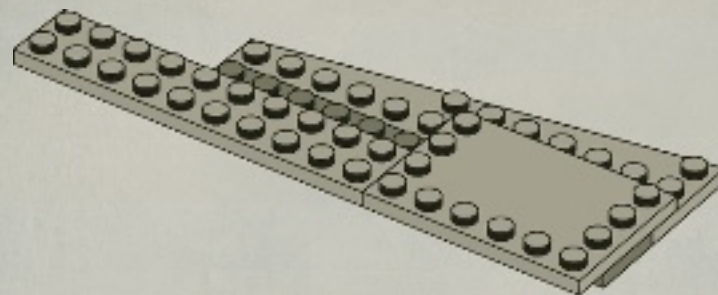

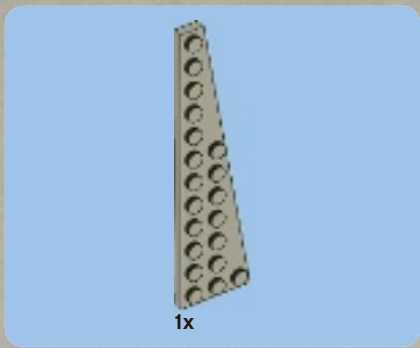

5

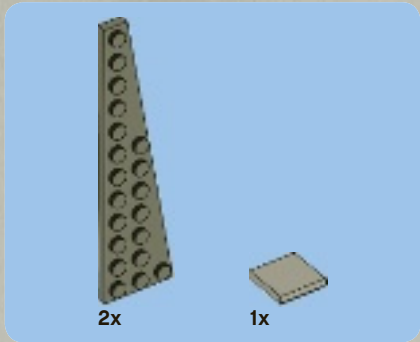
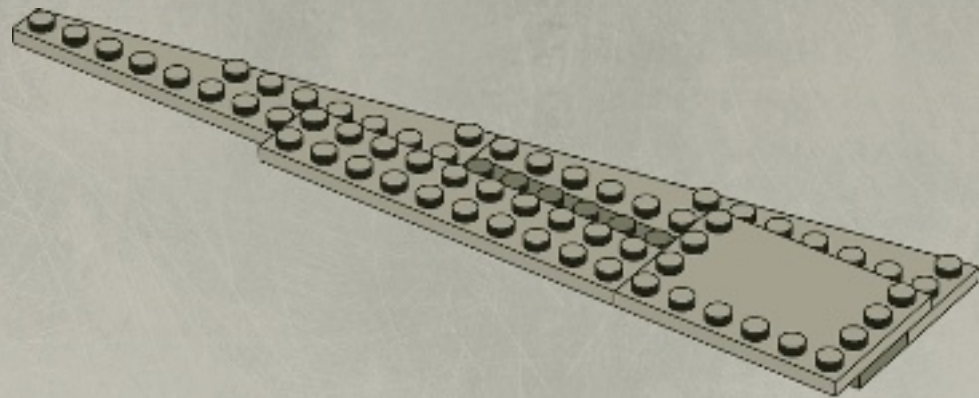

6

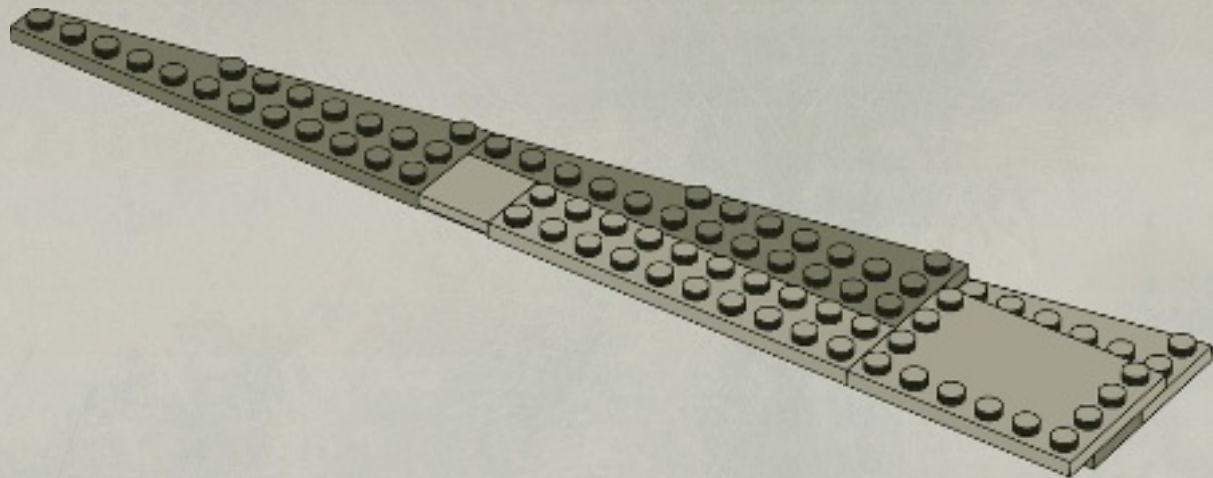



3x

7

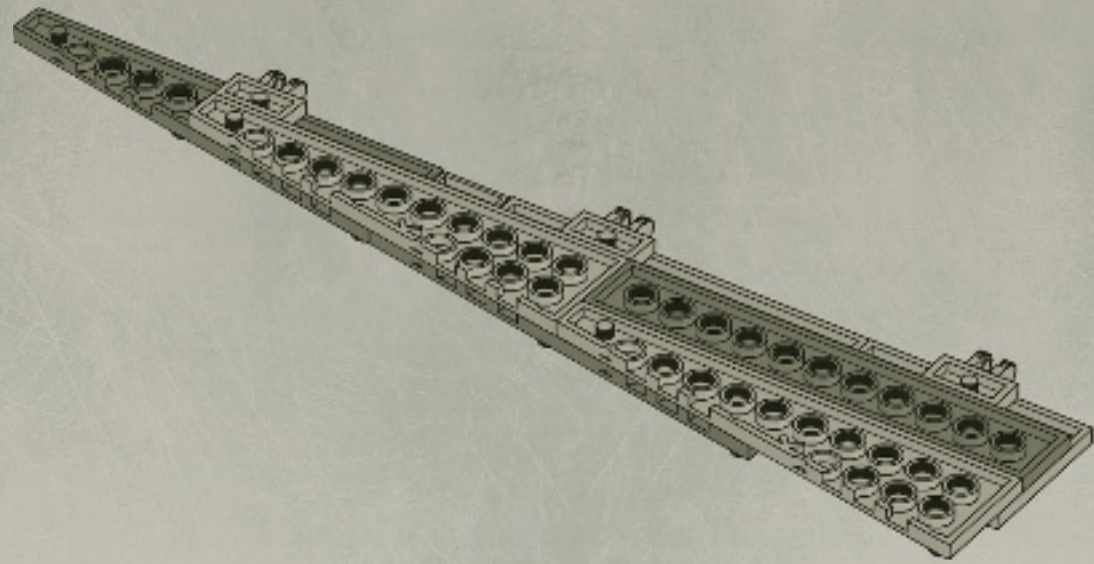

3x

8

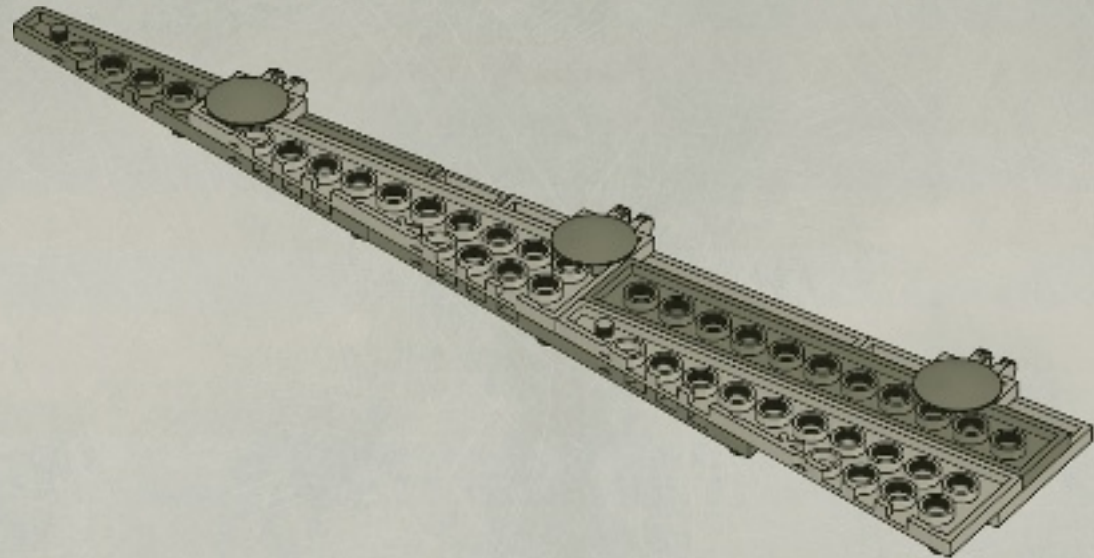



9

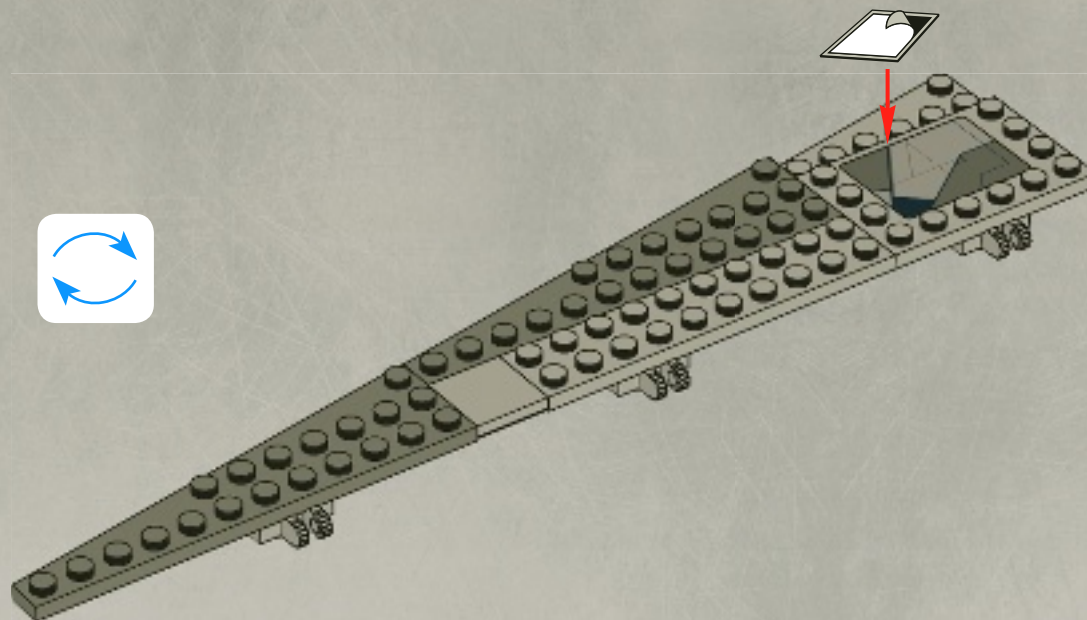

13

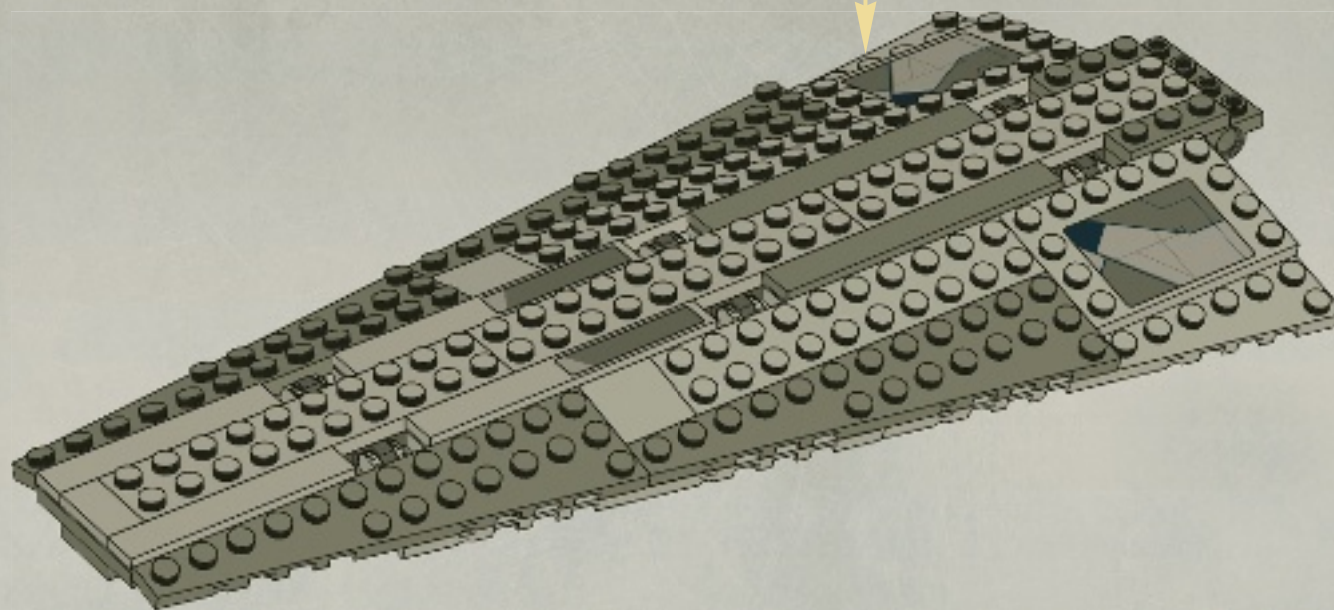

14

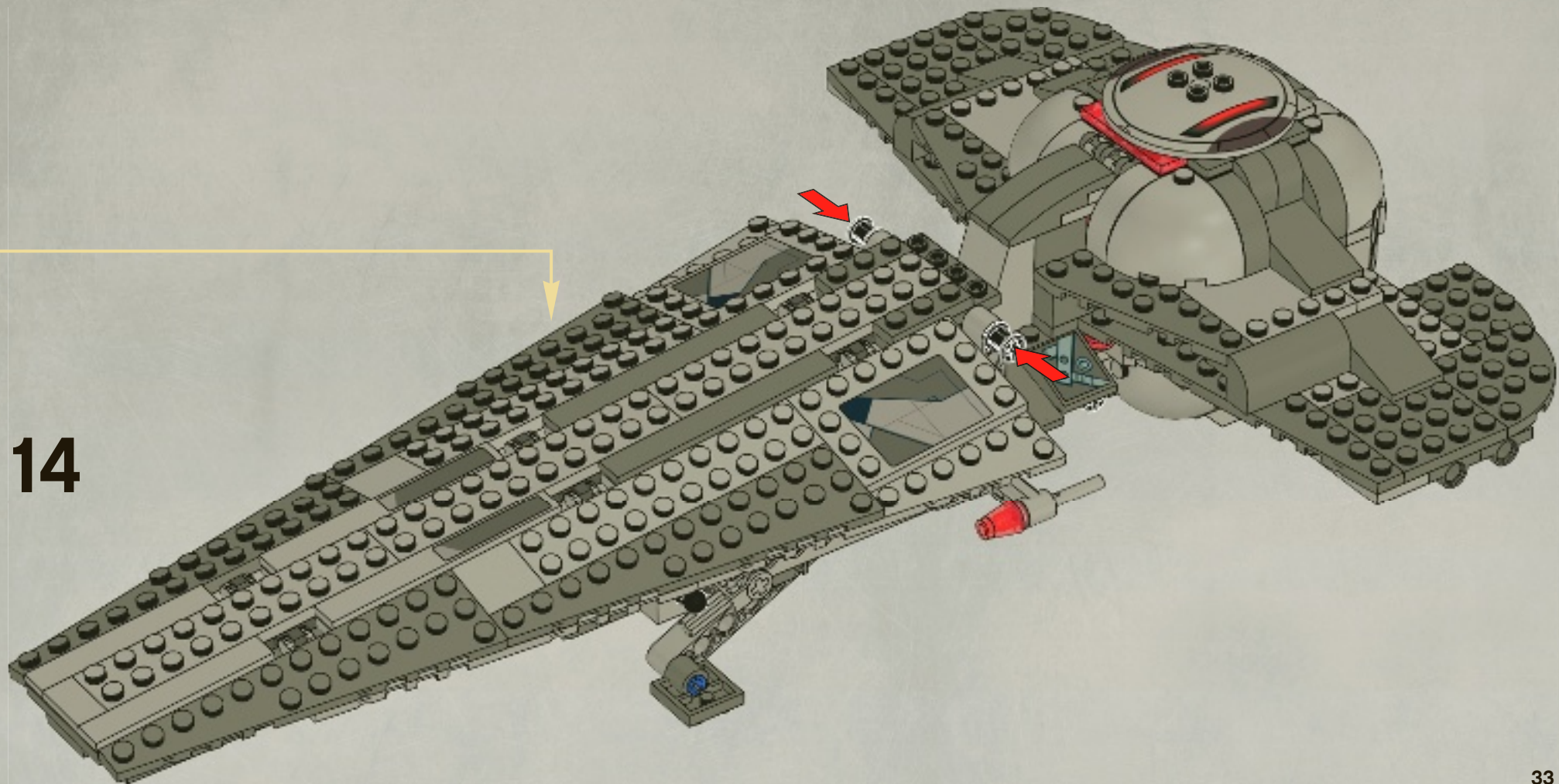

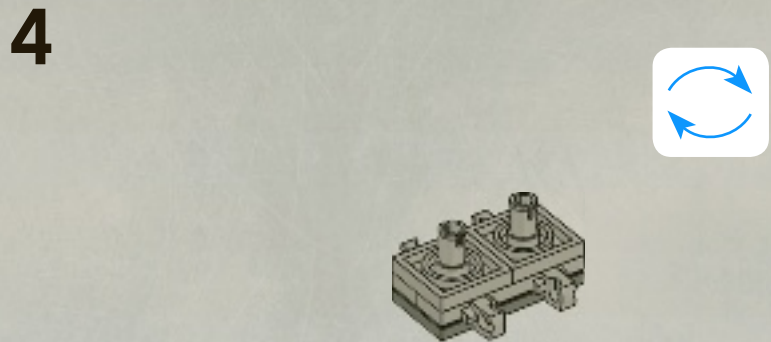
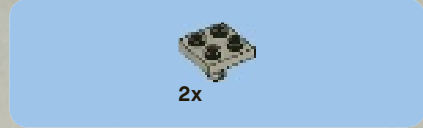
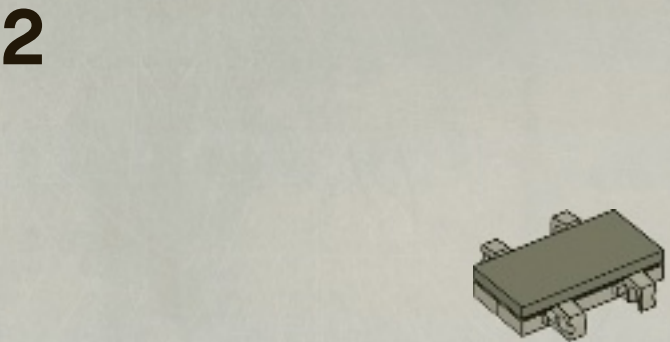
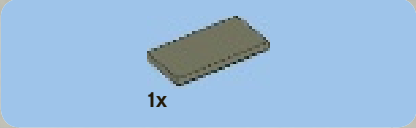
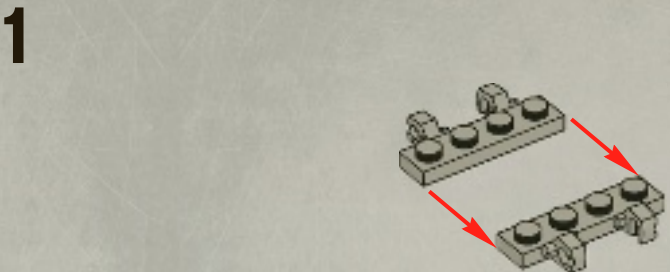

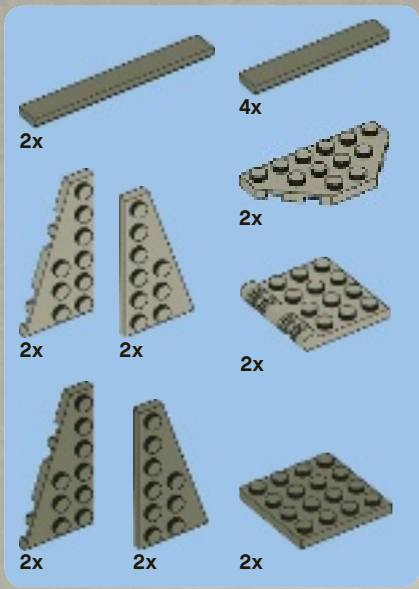

5

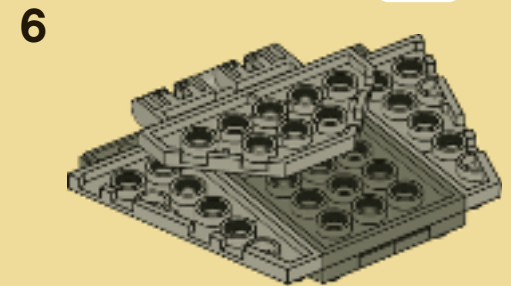
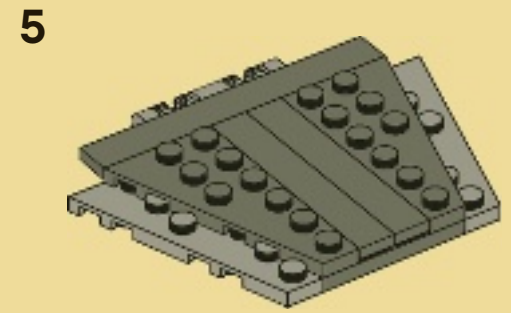
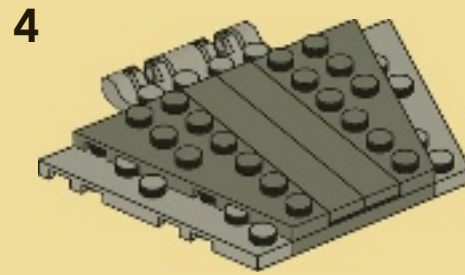
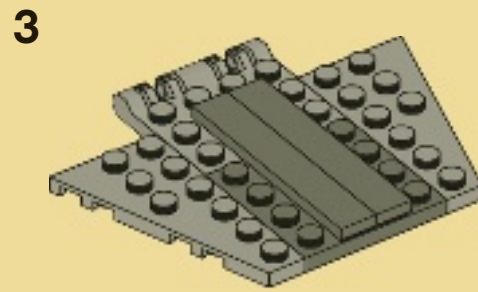
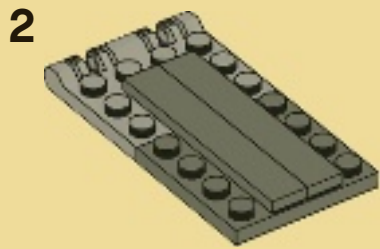
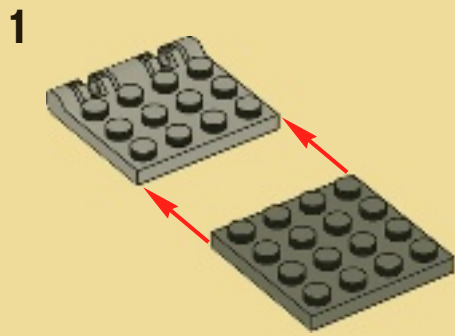

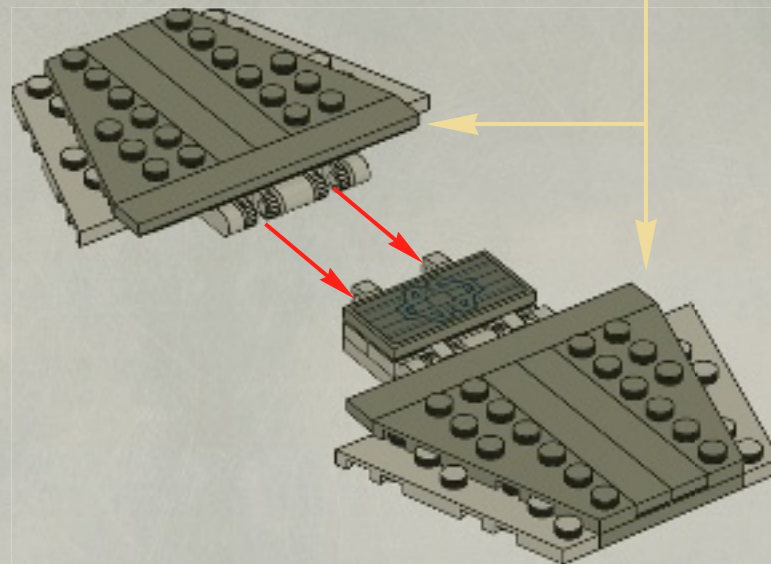

2x

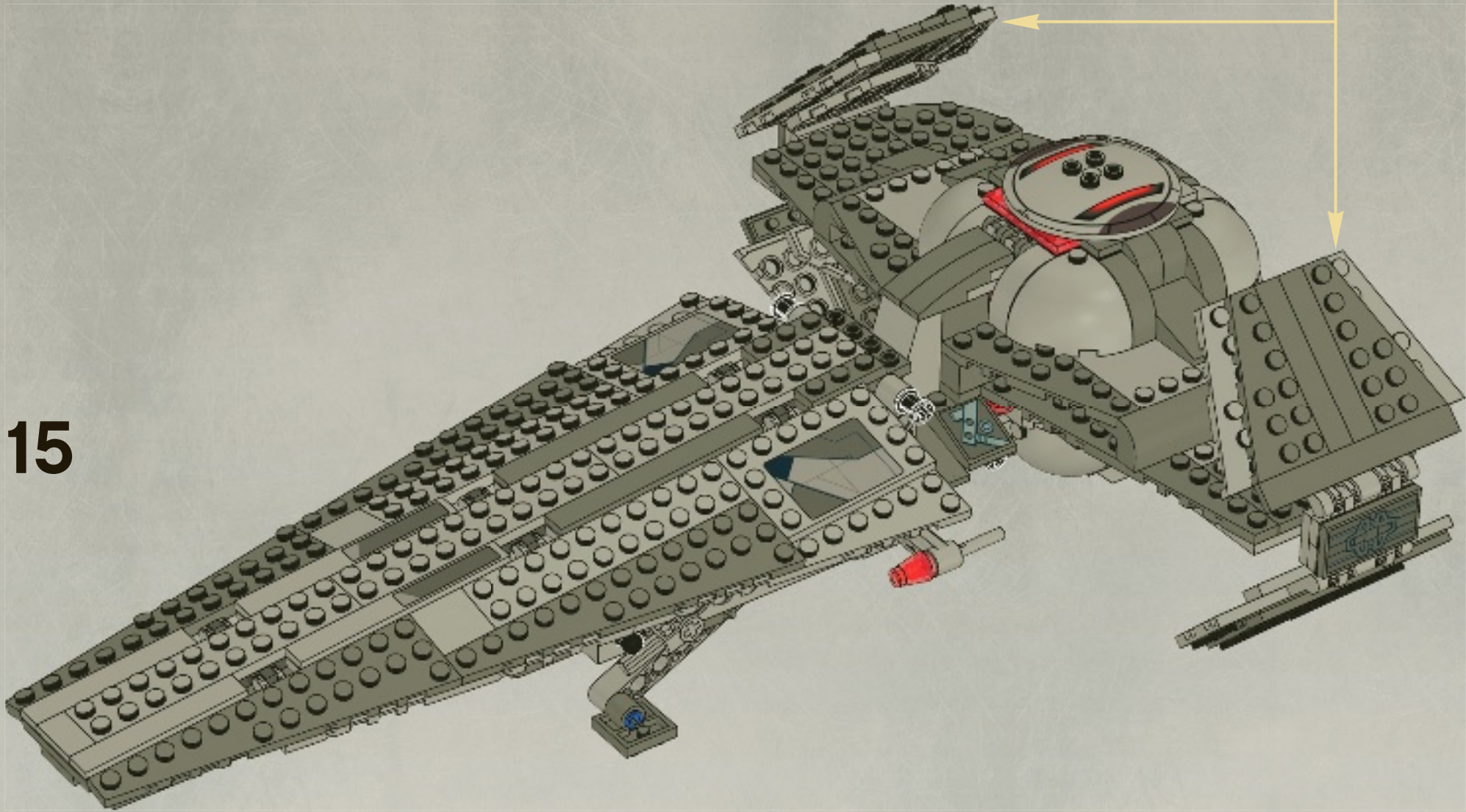

2x

15



Customer Service
Kundenservice
Service Consommateurs
Servicio Al Consumidor
www.lego.com/service or dial

: 00800 5346 5555
: 1-800-422-5346





Darth Maul™



Captain Panaka™



Padmé™



Qui-Gon Jinn™



7956



7957



7961



7962



7964



7965

STAR WARS

LEGO





STAR WARS III

THE CLONE WARS™



videogames.LEGO.com
www.LucasArts.com

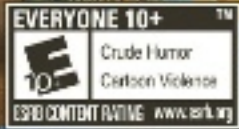

LEGO, the LEGO logo, the LEGO minifigure, and the word "LEGO" are registered trademarks of the LEGO Group, © 2005-2010. LucasArts, the LucasArts logo, and the word "LucasArts" are registered trademarks of LucasArts Ltd. © 2005-2010. LucasArts Entertainment Company Ltd. or LucasArts Ltd. All rights reserved. LucasArts, the LucasArts logo, and the word "LucasArts" are registered trademarks of LucasArts Ltd. © 2005-2010. LucasArts Entertainment Company Ltd. or LucasArts Ltd. All rights reserved. LEGO, the LEGO logo and the Minifigure are trademarks of the LEGO Group. All rights reserved. This does not imply that LEGO is a LucasArts product.

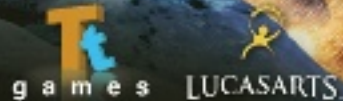



www.LEGOclub.com

LEGO club

FREE! GRATIS! GRATUIT!



LEGO Club Magazine



LEGO Club Email



YES! I want to join the LEGO® Club FREE! **OUI!** Je veux m'abonner au LEGO® Club GRATUITEMENT!
Ja! Ich möchte Mitglied im kostenlosen LEGO® Club werden. **Ja!** Ik wil graag GRATIS lid worden van de LEGO® Club.
Ja! Jeg ønsker å melde meg inn i LEGO® Club gratis! **Ja!** Jag vill gå med i LEGO® Club GRATIS!

First name · Prénom
 Vorname · Voornaam
 Fornavn · Förnamn

Last name · Nom de famille
 Name · Achternaam
 Etternavn · Efternamn

Date of Birth · Date de naissance
 Geburtstag · Geboortedatum
 Fødselsdato · Födelsedatum

Boy · Garçon · Junge ·
 Jongen Gutt · Pojke

Girl · Fille Mädchen ·
 Meisje Jente · Flicka

Street · Adresse
 Straße, Hausnr.
 Straat, huisnr.
 Address

City · Ville
 Ort · Woonplaats
 Poststed · Postort

State
 Prov. County

Zip/Postcode · Code
 Postal · PLZ · Postcode ·
 Postnummer

Country
 Pays · Land

Email · Courriel ·
 E-Mail · E-post

- Fill in your email address and we will send you a membership confirmation and monthly email newsletters. If you do not wish to receive the newsletters please tick here. Remplis ton adresse e-mail et nous t'enverrons une confirmation d'adhésion ainsi que le bulletin e-mail mensuel. Si tu ne désires pas recevoir le bulletin, coche cette case. Vul je e-mailadres in en we sturen je een bevestiging van je lidmaatschap en maandelijke e-mail nieuwsbrieven. Als je geen e-mail wilt ontvangen, kruis dan dit vakje aan.
- Ich möchte per E-Mail den monatlichen LEGO Club Newsletter erhalten. Ønsker du at vi skal sende en liten hilsen til barnet ditt for å bekrefte medlemskapet, ber vi deg krysse av i feltet, samt oppgi e-postadressen som hilsenen skal sendes til. Om du vill att vi ska skicka en bekräftelse på ditt barns medlemskap, ber vi dig sätta ett kryss i rutan och skriva den e-post adress som bekräftelsen ska skickas till.
- If you do not wish to receive additional mailings from the LEGO Club please tick here. Si tu ne désires pas recevoir de courrier supplémentaire du Club LEGO, coche cette case. Als je geen verdere post van de LEGO Club wilt ontvangen, kruis dan dit vakje aan.
- Dersom du ønsker å motta annen informasjon fra LEGO Gruppen, setter du et kryss her.

Mail to: / Poster à: LEGO® Club
 P.O. Box 1157
 Enfield, CT USA
 06083-1157

Per Post an: LEGO® Club
 Postfach 14 15
 D-36243 Niederaula

Send til: LEGO® Club Norge
 Postboks 58
 1314 Vøyenenga

Mail to: LEGO® Club
 33 Bath Road
 Slough SL1 3UF
 United Kingdom

Stuur op naar: LEGO® Club
 Postbus 40250
 3504 AB Utrecht

Skickas till: LEGO® Club Sverige
 Ubox 841
 202 29 Malmö

Poster à: LEGO® Club
 21 rue de la Banque
 75 002 PARIS
 FRANCE

The English language version of the magazine can only be mailed to addresses in the US, Canada, the UK, and Republic of Ireland. Club membership is valid for two years and includes free copies of the LEGO Club Magazine and e-mail newsletters. In the US and Canada please allow up to 6 weeks for delivery of your first magazine. In the UK and Republic of Ireland please allow six to 14 weeks for delivery of your first magazine. By signing this form you consent the LEGO Club to use your child's data for LEGO mailings. The data will only be used for LEGO mailings and will not be sold, rented or otherwise disclosed to any company outside the LEGO Company except for disclosure to companies acting as our agents to help us provide services requested by the child. This coupon is valid for one free membership per person, group or organization. Photocopied coupons are accepted. La version française du magazine peut être postée uniquement au Canada. L'abonnement est valide pour 2 ans et inclut des exemplaires gratuits du Magazine LEGO, Aux E.-U. et au Canada, allouer 6 semaines pour la livraison initiale. En remplissant ce formulaire, vous consentez à ce que LEGO utilise les informations de votre enfant pour des envois postaux de LEGO. L'information sera utilisée uniquement pour des envois postaux par LEGO et ne sera en aucun cas, vendue, louée, échangée ou divulguée à d'autres compagnies autres que la compagnie LEGO, à l'exception des compagnies affiliées à qui nous pourrions divulguer des services auxquels l'enfant en a fait la demande. Formulaires photocopiés acceptés. Mit der folgenden Unterschrift erkläre ich, für mein Kind den Beitritt als Mitglied zum kostenlosen LEGO Club, der von der LEGO GmbH, D-85627 Grasbrunn, betrieben wird. Die Mitgliedschaft beinhaltet die Zusendung des LEGO Club Magazins und kann beiderseits jederzeit beendet werden. Mit der Mitgliedschaft in LEGO Club sind keinerlei Verpflichtungen verbunden. Das deutschsprachige LEGO Club Magazin wird nur an Adressen in Deutschland, Österreich und der Schweiz versendet. Eine Anmeldebestätigung kann nur per E-Mail geschickt werden. Das Magazin erscheint fünfmal jährlich. Daher kann die Zustellung des ersten Heftes bis zu drei Monate dauern. Die Mitgliedschaft ist beidseitig jederzeit kündbar, ohne dass Ihnen Kosten entstehen. Sie können der werblichen Nutzung Ihrer Daten jederzeit widersprechen. Kündigung und Widerspruch können Sie telefonisch erklären (00800 / 5346 5555, Anruf gebührenfrei, Kosten für Anrufe aus dem Mobilfunknetz können abweichen) oder an die LEGO GmbH senden. Het Nederlandse LEGO Club Magazine kan alleen worden gestuurd naar adressen in Nederland. Het lidmaatschap is 2 jaar geldig en geeft recht op toezending van het gratis LEGO Club Magazine en LEGO Club e-mails. Het eerste magazine zal binnen 12 tot 14 weken toegestuurd worden. Het lidmaatschap kan op ieder moment opgezegd worden en kan na 2 jaar gratis worden verlengd, tenzij LEGO met deze activiteit stopt. Uw gegevens worden uitsluitend gebruikt voor mailings van LEGO en zullen niet worden verkocht, verhuurd of op welke wijze dan ook versprekt aan derden buiten de LEGO Groep, uitgezonderd de organisaties die namens ons optreden om de informatie te sturen waarvoor toestemming is verleend. Den norske utgaven av magasinet sendes kun til adresser i Norge. Medlemskap i klubben gjelder i 2 år og inkluderer gratisutgaver av LEGO Club Magazine. Pæring minimum opp til seks uker leveringstid for første magasin. Ved å undertegne dette skjemaet, gir du ditt samtykke til at LEGO Club kan bruke opplysninger om barnet ditt i LEGO forsendelser. Dataene vil utelukkende bli brukt i LEGO forsendelser og vil ikke bli solgt, utleid eller på annen måte gøres tilgjengelig for selskaper utenfor LEGO gruppen, unntatt selskaper som er våre agenter og som hjelper oss å tilby tjenestene barnet etterspør. Dette skjemaet gjelder for ett gratis medlemskap per person, gruppe eller organisasjon. Den svenska versionen av tidsningen kan endast skickas till adresser i Sverige. Club-medlemskapet är giltigt i 2 år och innefattar barnets exemplar av LEGO Club Magazine. Vämligen räknas med minimum 6 veckor för leverans av din första tidning. Genom att skicka in det här formuläret godkänner du att LEGO Club använder barnets uppgifter för LEGO utskick. Uppgifterna kommer bara att användas för LEGO utskick och kommer inte att säljas, hyras ut eller vidarebefordras till något företag som inte tillhör LEGO Gruppen, med undantag av företag som agerar som våra ombud för att tillhandahålla tjänster som barnet har begärt. Den här kupongen gäller för ett gratis medlemskap per person, grupp eller organisation. En complément ce bulletin d'adhésion, vous acceptez que LEGO Club utilise les données relatives à votre enfant pour l'envoi de courriers concernant LEGO. Ces données seront uniquement utilisées pour l'envoi d'information concernant LEGO et ne seront ni vendues, ni louées, ni utilisées par d'autres sociétés que le groupe LEGO, à l'exception des sociétés agissant pour le compte de LEGO en tant que sous-traitant de services divers. L'abonnement au LEGO Club est valable pour une période de 2 ans, il inclut l'envoi par courrier du magazine LEGO Club et par email des newsletters. Un délai de 6 à 14 semaines est à prévoir pour la réception de votre premier magazine. Ce bulletin d'adhésion gratuit est valable pour l'inscription d'une seule personne. Les photocopies sont acceptées. ATTENTION! Le bulletin d'adhésion doit être rempli et signé par un parent ou un tuteur.

VISIT THE WORLD'S
 BIGGEST LEGO® SHOP
 www.LEGOshop.com

www.LEGOclub.com

00800 5346 5555

1-866-534-6258 · 1-877-518-5346

* Freephone. Mobile charges may apply. * Numéro sans frais. Des frais peuvent s'appliquer avec les téléphones cellulaires. * Gebührentfrei, Kosten für Anrufe aus Mobilfunknetzen können abweichen. * Gratis telefonnummer vanaf vaste lijn. * Det er et gratis nummer, når du ringer fra fasttelefon. * Det är gratis, när du ringer från en fast telefon. * Numéro sans frais. Des frais peuvent s'appliquer avec les téléphones portables.

Parent's signature · Signature d'un parent ou d'un tuteur
 * Unterschrift Erziehungsberechtigter / Handtekening ouders
 * Foreldres/foresattes underskrift · Förälders /förmyndares underskrift

Date
 Datum
 Date



WIN!

Go to www.LEGOsurvey.com/product to fill out a survey for a chance to win a cool LEGO® Product. No purchase necessary. Open to all residents where not prohibited.

 www.LEGO.com



www.LEGOsurvey.com/product

GEWINNE!

Nimm an der Umfrage auf www.LEGOsurvey.com/product LEGO teil und hab die Chance ein cooles LEGO® Produkt zu gewinnen!
Die Teilnahme am Gewinnspiel führt zu keinerlei Kaufverpflichtungen. Teilnahme in allen nicht ausgeschlossenen Ländern möglich.

WIN!

Ga naar www.LEGOsurvey.com/product, vul een enquêteformulier in en maak kans op een cool LEGO® product.
Geen aankoopverplichting, Iedereen mag deelnemen, uitgezonderd ingezetenden van landen waar een enquêteverbod geldt.

GAGNE!

Visite www.LEGOsurvey.com/product pour répondre à un questionnaire et avoir une chance de gagner un produit LEGO® très cool !
Aucune obligation d'achat. Ouvert à tous les résidents des pays autorisés.

当てよう!

www.LEGOsurvey.com/product にアクセスして、アンケートにご記入ください。当選者にはレゴ®製品を差し上げます。
お買い上げの必要はありません。禁止されていない限り、すべての皆様にご利用いただけます。