



STAR WAR



75055



LEGO.com



EN IMPORTANT: Never modify the elements or use other projectiles than provided with this toy.
DE WICHTIG: Die Elemente dürfen nicht verändert werden. Es dürfen ausschließlich die mit dem Spielzeug mitgelieferten Geschosse verwendet werden.
FR IMPORTANT : Ne jamais modifier les éléments ni utiliser d'autres projectiles que ceux fournis avec ce jouet.
IT IMPORTANTE: non modificare gli elementi o utilizzare proiettili non forniti con questo prodotto.
NL BELANGRIJK! Verander niets aan de elementen en gebruik geen andere projectielen dan de bij het speelgoed geleverde.
ES IMPORTANTE: No modifique los elementos ni utilice otros proyectiles diferentes a los suministrados junto con este juguete.
DA VIGTIGT: Elementerne må ikke ændres, og der må ikke bruges andre projektiler end dem, der følger med legetøjet.
FI TÄRKEÄÄ: Älä koskaan tee osiin muutoksia tai käytä lelussa muita kuin sen sisältämiä ammuksia.
SV VIKTIGT: Modifiera aldrig delarna och använd aldrig andra projektiler än de som medföljer denna leksak.
PT IMPORTANTE: Nunca modifique os elementos nem utilize projéteis que não tenham sido fornecidos com este brinquedo.
EL ΣΗΜΑΝΤΙΚΟ: Ποτέ μην τροποποιείτε τα στοιχεία του παιχνιδιού και μην χρησιμοποιείτε άλλα βλήματα εκτός από αυτά που συνοδεύουν αυτό το παιχνίδι.
JA 重要：部品を改造したり、本製品に付属の発射体以外のものを使用しないようにしてください。
ZH 重要提示：切勿更改组件或使用并非由本玩具附带的弹丸。
KO 중요함: 이들 부품을 수정하거나 이 완구와 함께 제공된 것이 아닌 발사체는 결코 사용하지 마십시오.
RU ВАЖНО: запрещается вносить изменения в элементы или использовать другие снаряды, отличные от тех, которые поставляются с данной игрушкой.
PL WAŻNE: Nigdy nie modyfikować elementów zabawki ani nie używać pocisków innych niż dostarczone z zabawką.
CZ UPOZORNĚNÍ: Nikdy neupravujte součástky a nepoužívejte jiné projektily než ty, které jsou dodávány s touto hračkou.
SK UPOZORNENIE: Nikdy neupravujte súčasti a nepoužívajte iné projektily než tie, ktoré sú dodávané s touto hračkou.
HU FONTOS: Az elemeket nem szabad módosítani, és a játékhöz adott lövedékek helyett sem szabad mást használni.
UA ВАЖЛИВО: забороняється вносити зміни до елементів або використовувати інші снаряди на відміну від тих, що поставляються з цією іграшкою.
HR VAŽNO: Nemojte nikad mijenjati elemente ili koristiti druge projekte osim onih koji su bili priloženi uz ovu igračku prilikom kupnje.
SR Важно: Немојте да модификујете елементе и не користите друге пројектиле осим оних који долазе уз ову играчку.
SL POMEMBNO: Nikoli ne spreminjajte elementov in uporabljajte le izstrelke, ki so bili priloženi tej igrači.
RO IMPORTANT: Nu modificați niciodată elementele și nu utilizați alte proiectile decât cele furnizate cu această jucărie.
BG ВАЖНО: Не видоизменяйте елементите и не използвайте други снаряди освен приложените към тази играчка.
LV SVARĪGĪ! Nekad nepārveidojiet rotālietas elementus, vienmēr izmantojiet tikai tās komplektā iekļautās lodītes.
ET OLULINE: Mänguasja osi ei tohi teistega asendada, kasutada võib ainult kaasasolevat heitkeha.
LT DĖMESIO! Niekuomet nekeiskite elementų ir naudokite tik tuos šovinius, kurie yra pridėti prie šio žaislo.
TR ÖNEMLİ: Hiçbir zaman parçalarda değişiklik yapmayın veya bu oyuncakla sağlananlar dışında mermiler kullanmayın.

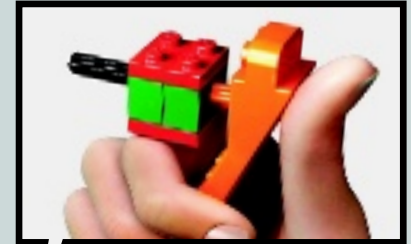

[LEGO.com/brickseparator](https://www.lego.com/brickseparator)



1

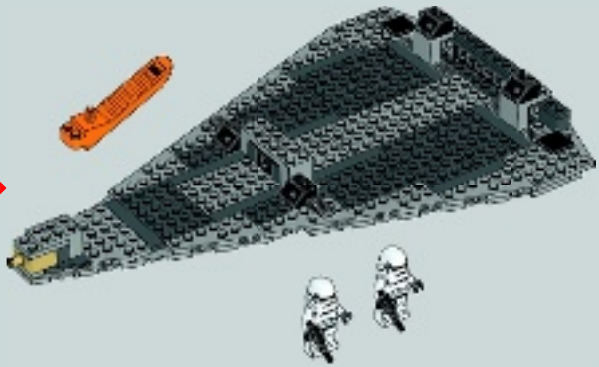

2



3

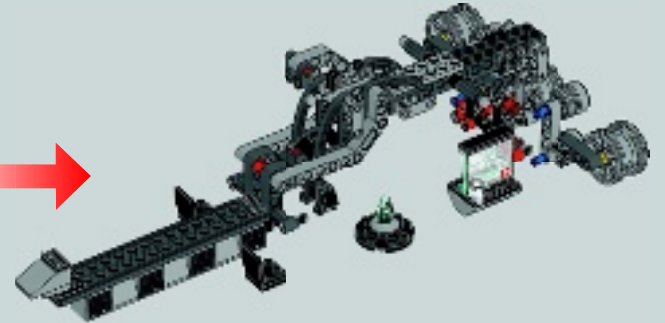

4

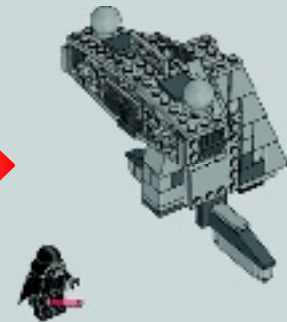



5

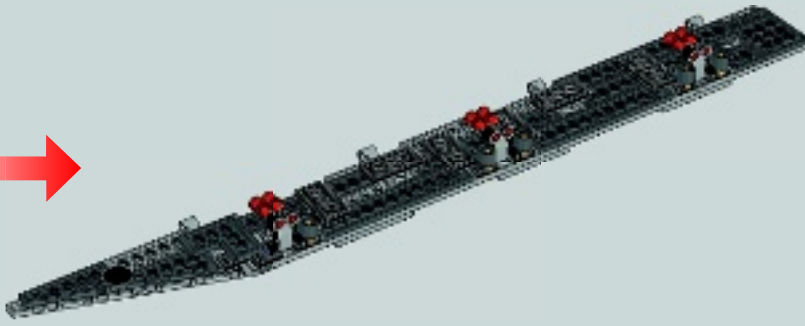

6

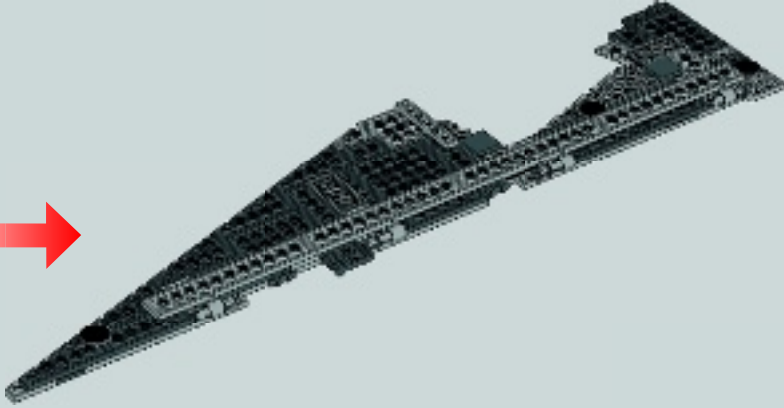

7

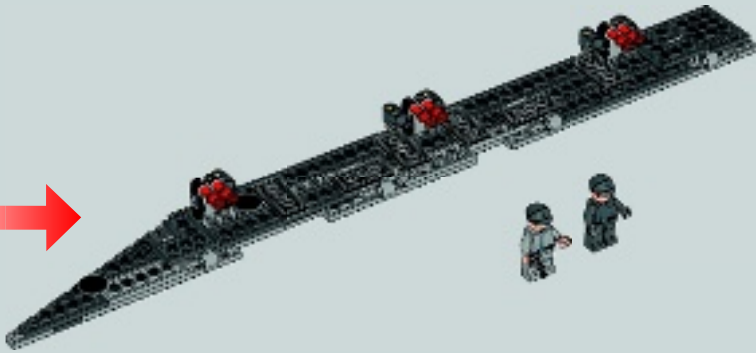

8

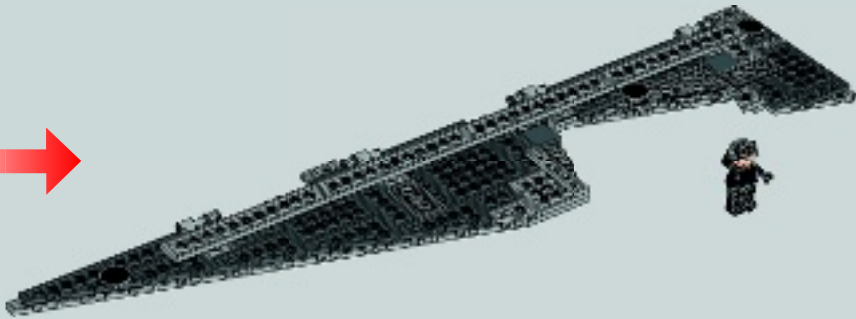

9

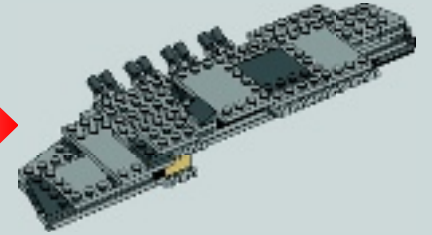

10

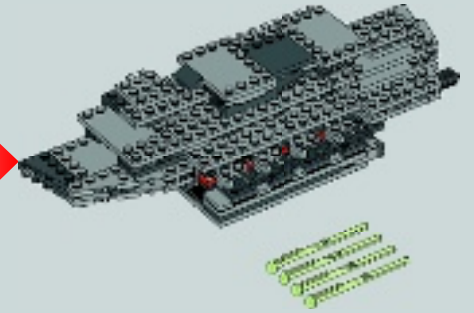

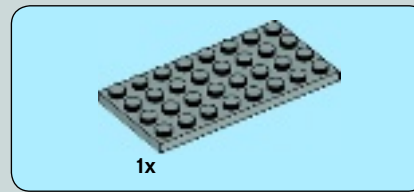
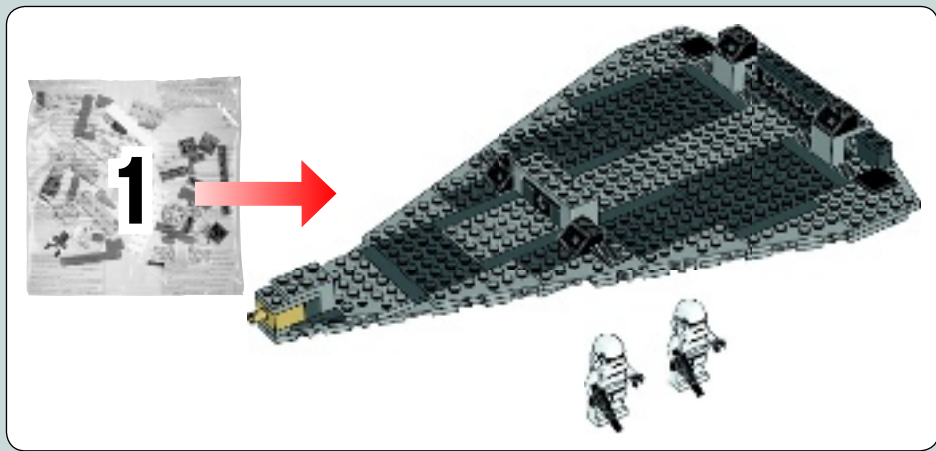

1

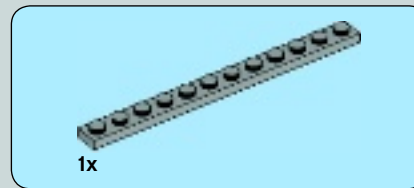
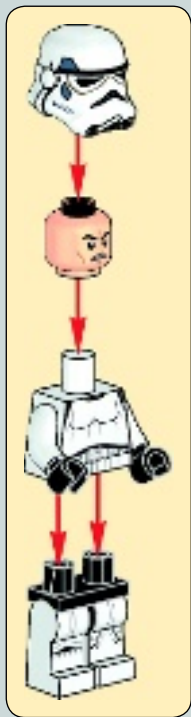
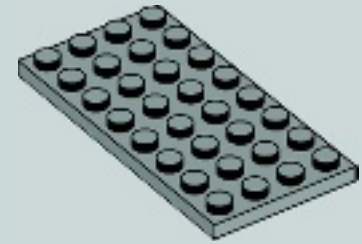

2

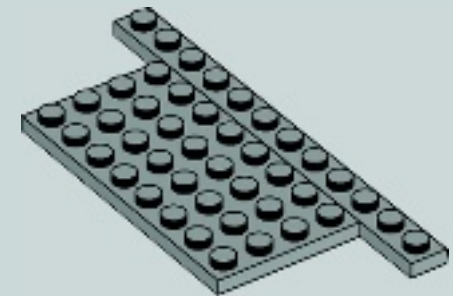

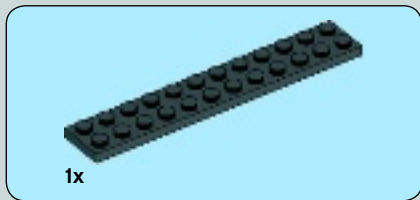

3



4

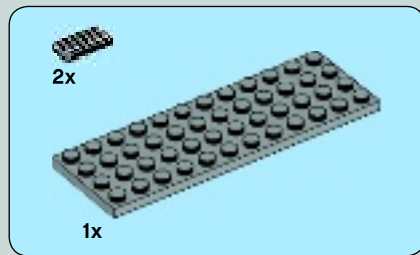
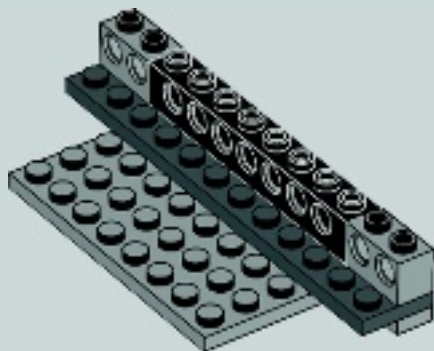

5

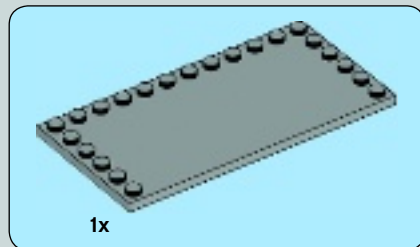
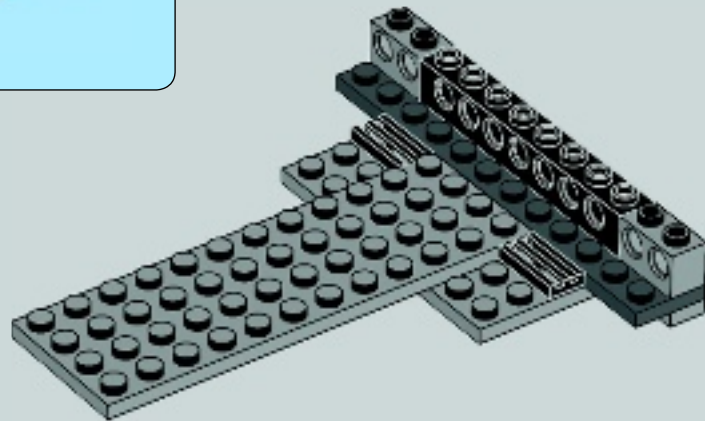

6

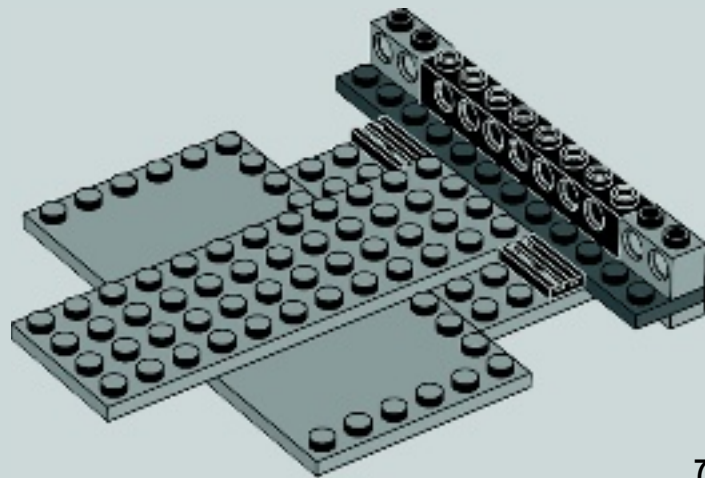

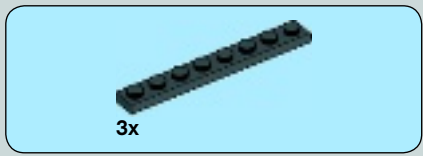

7

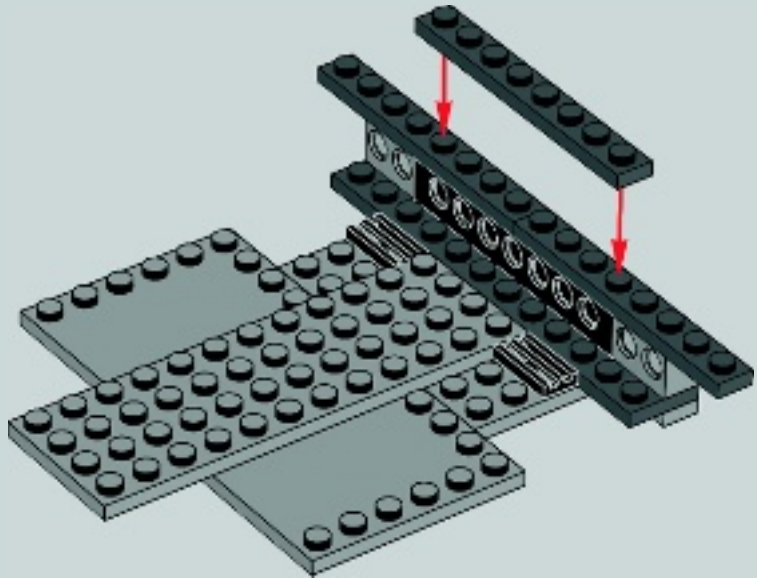

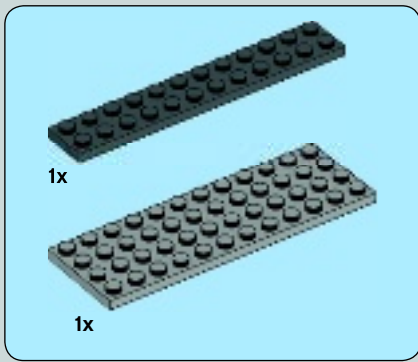

8

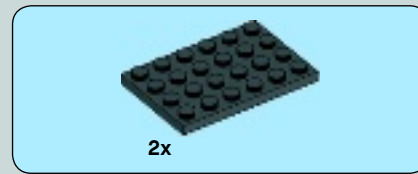
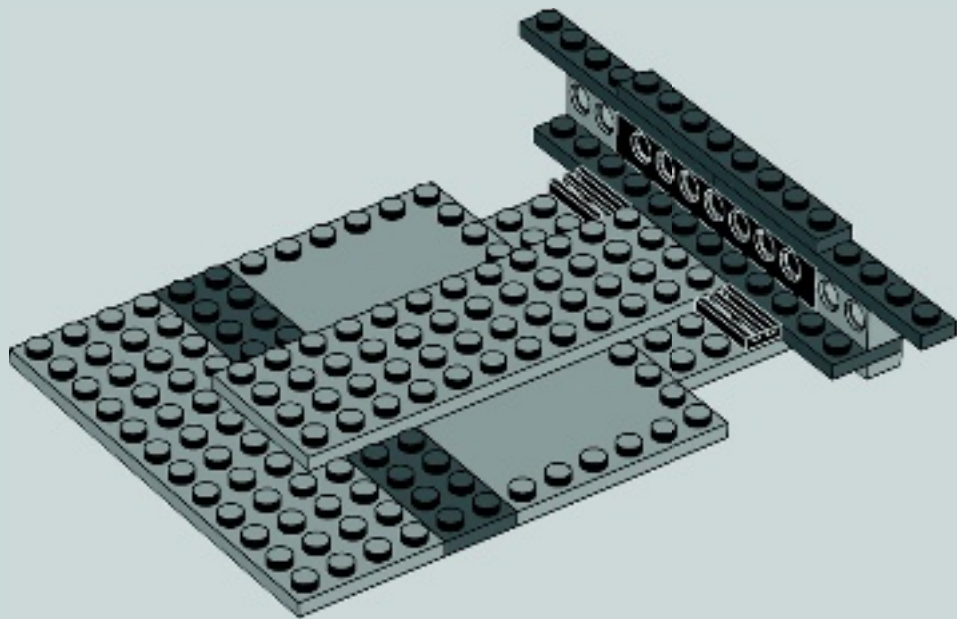

9

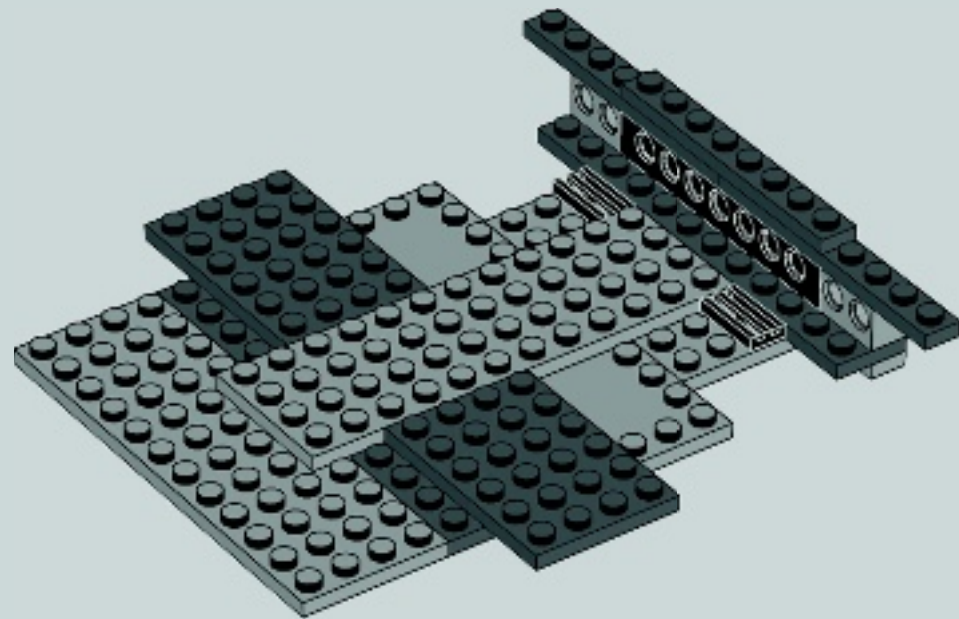

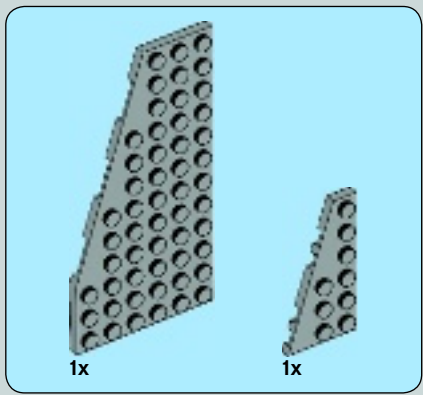

1

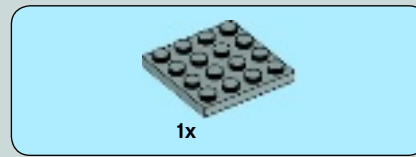
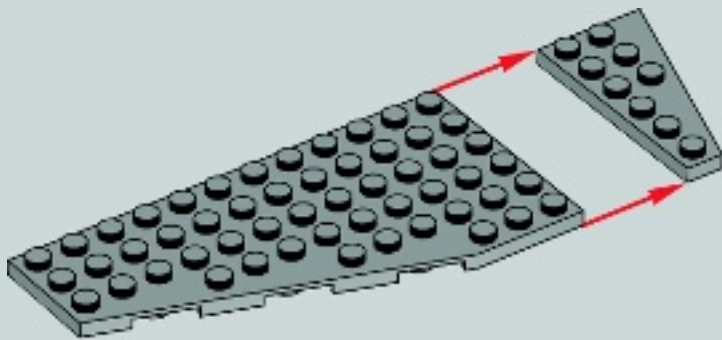

2

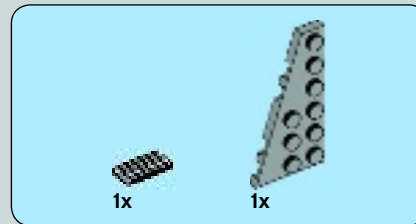
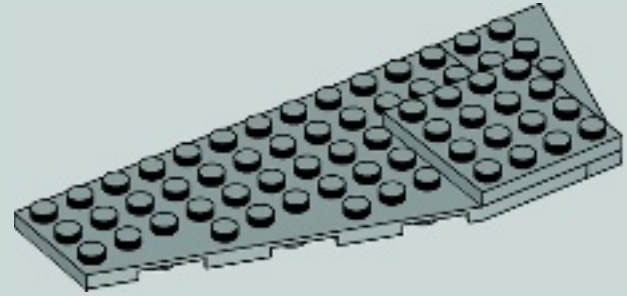

3

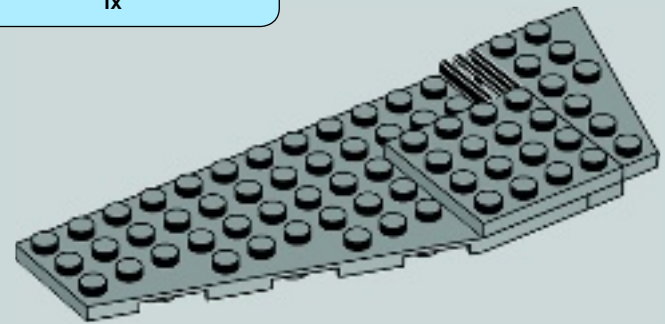

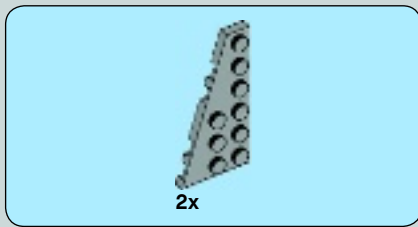

4

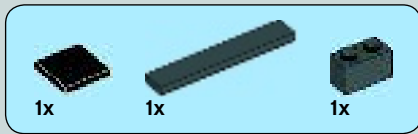
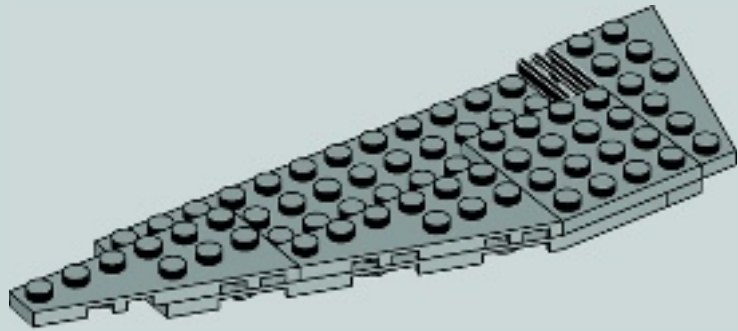

5

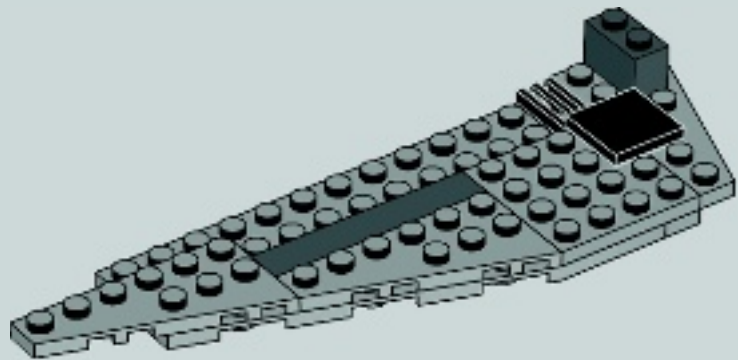

10

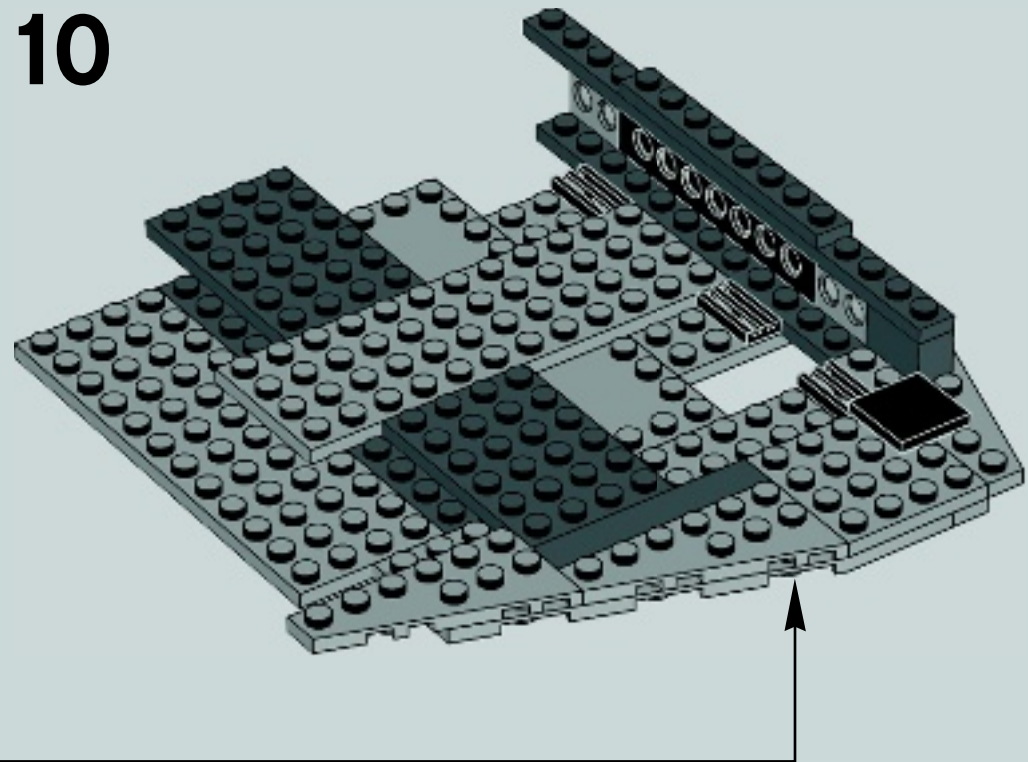

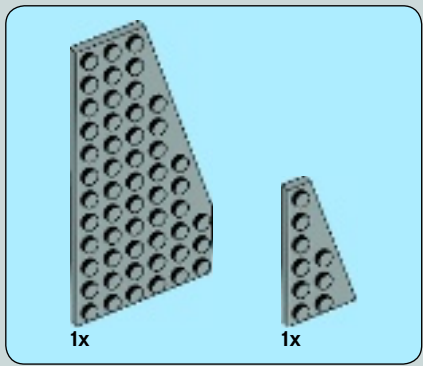

1

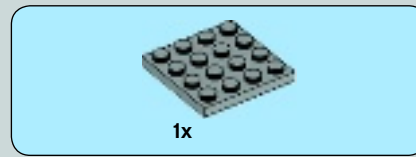
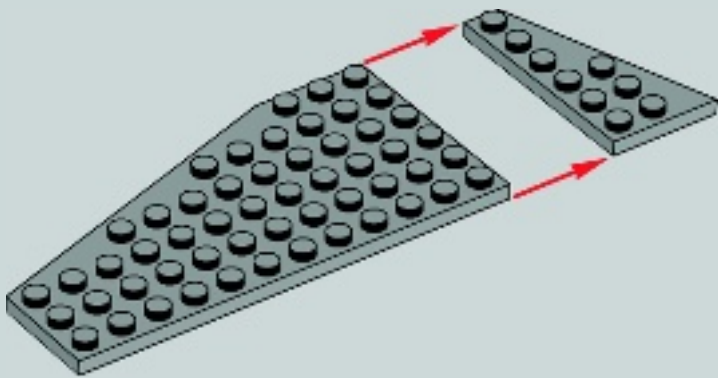

2

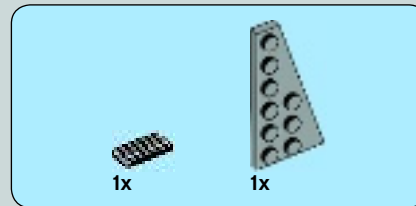
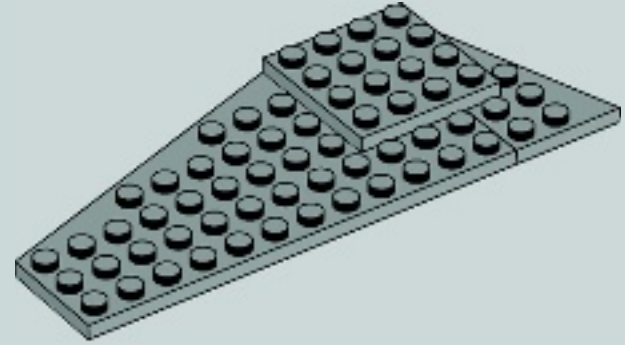

3

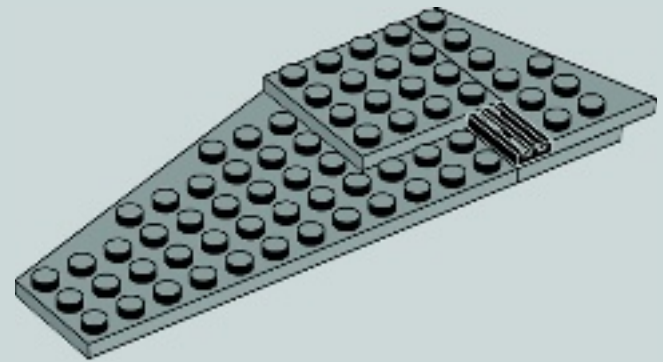

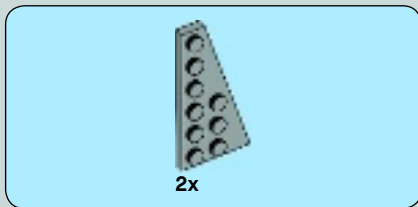

4

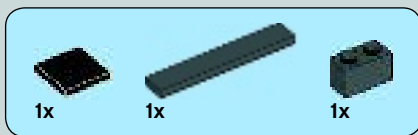
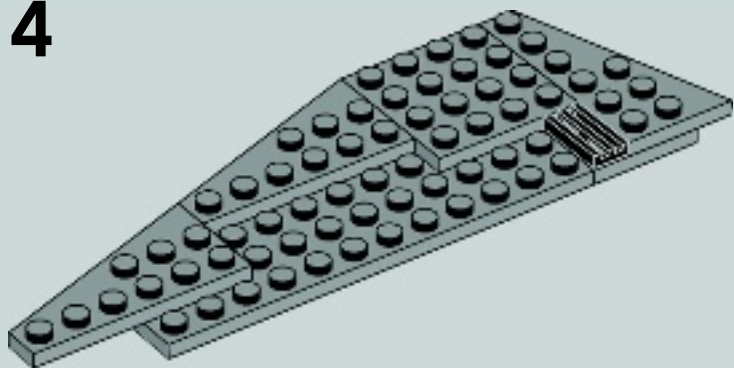

5

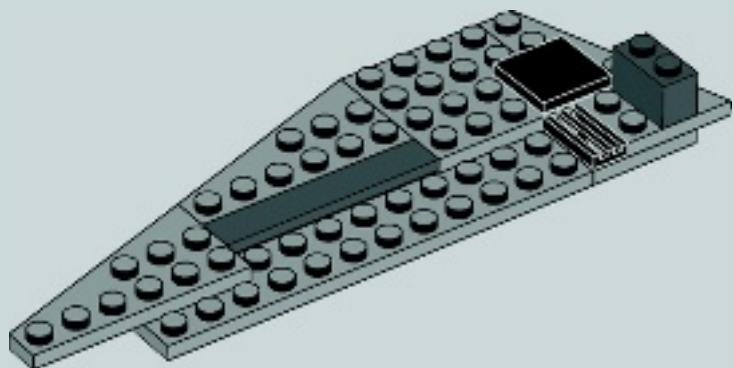

11

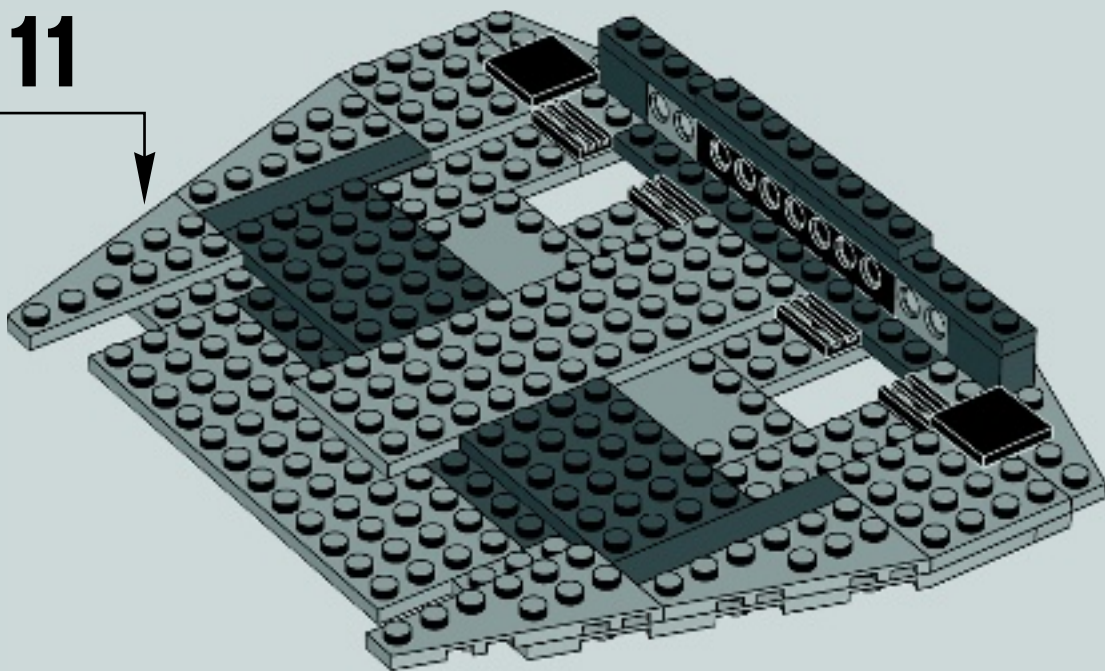

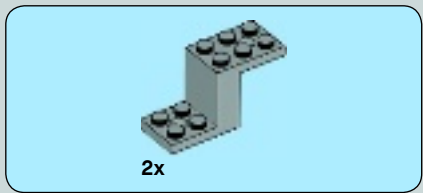

12

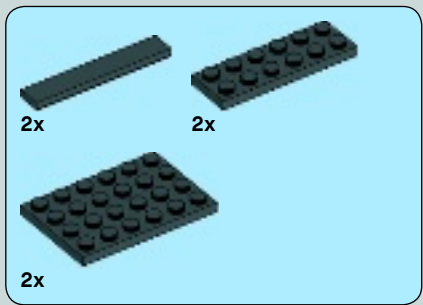
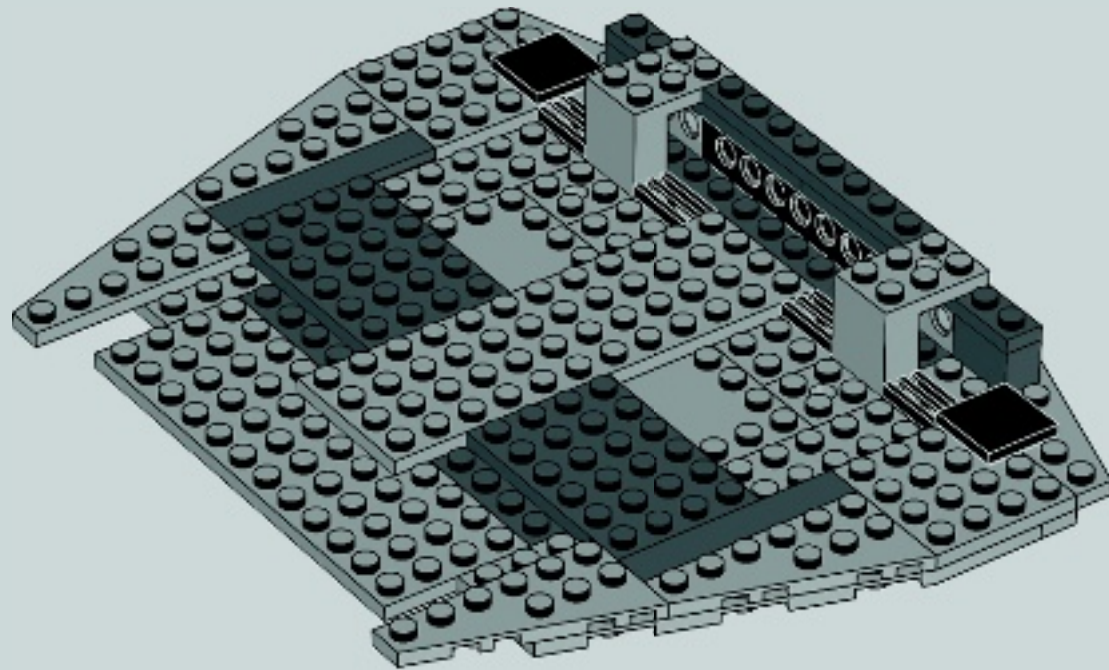

13

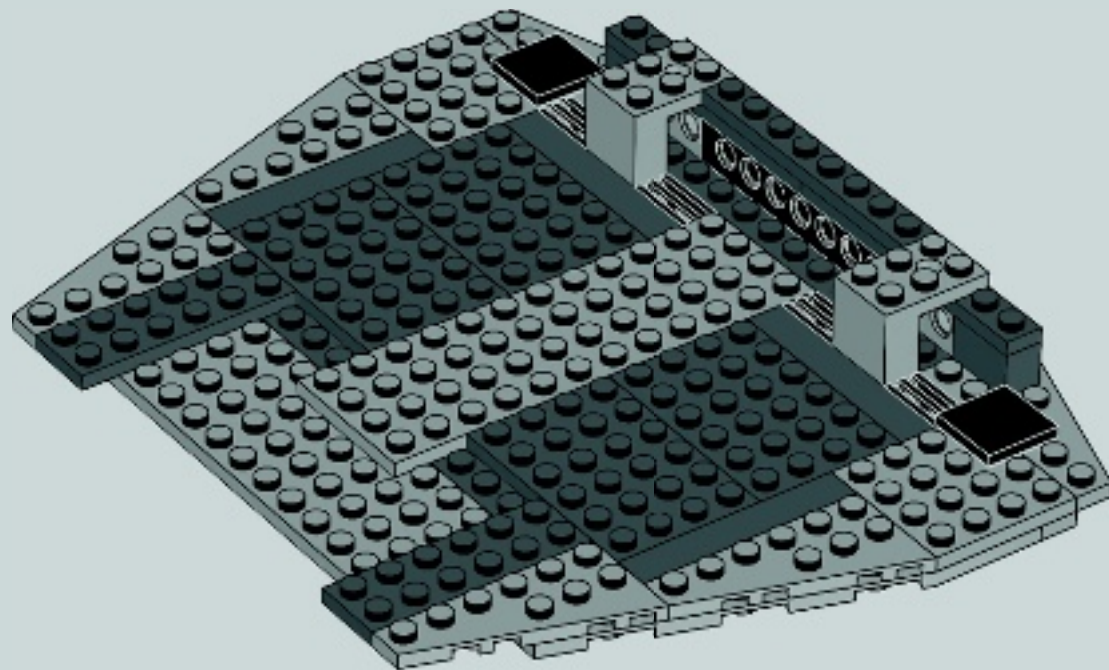

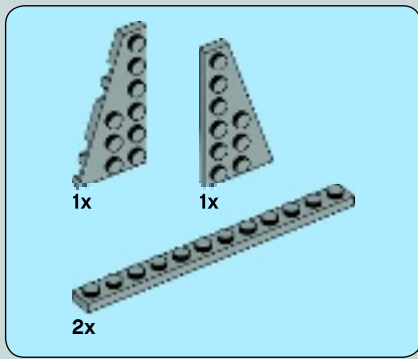

14

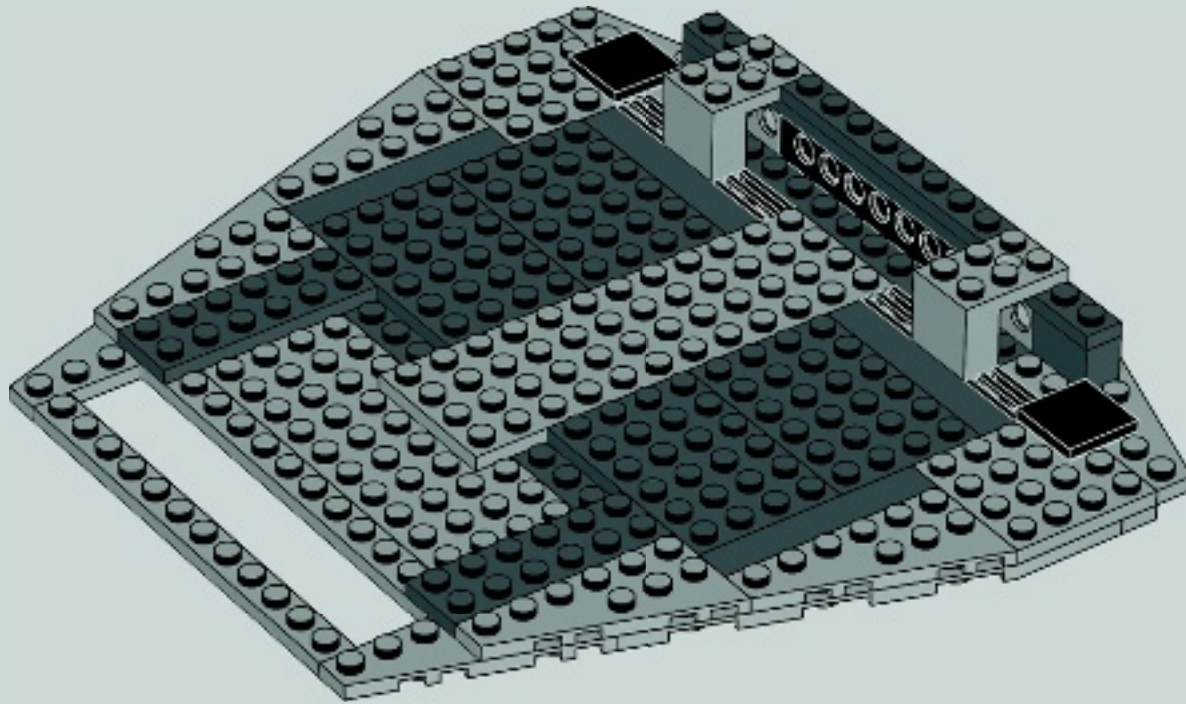

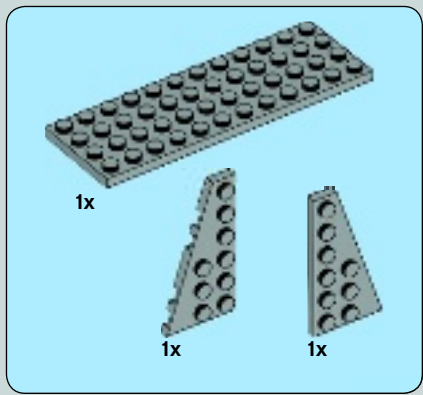

15

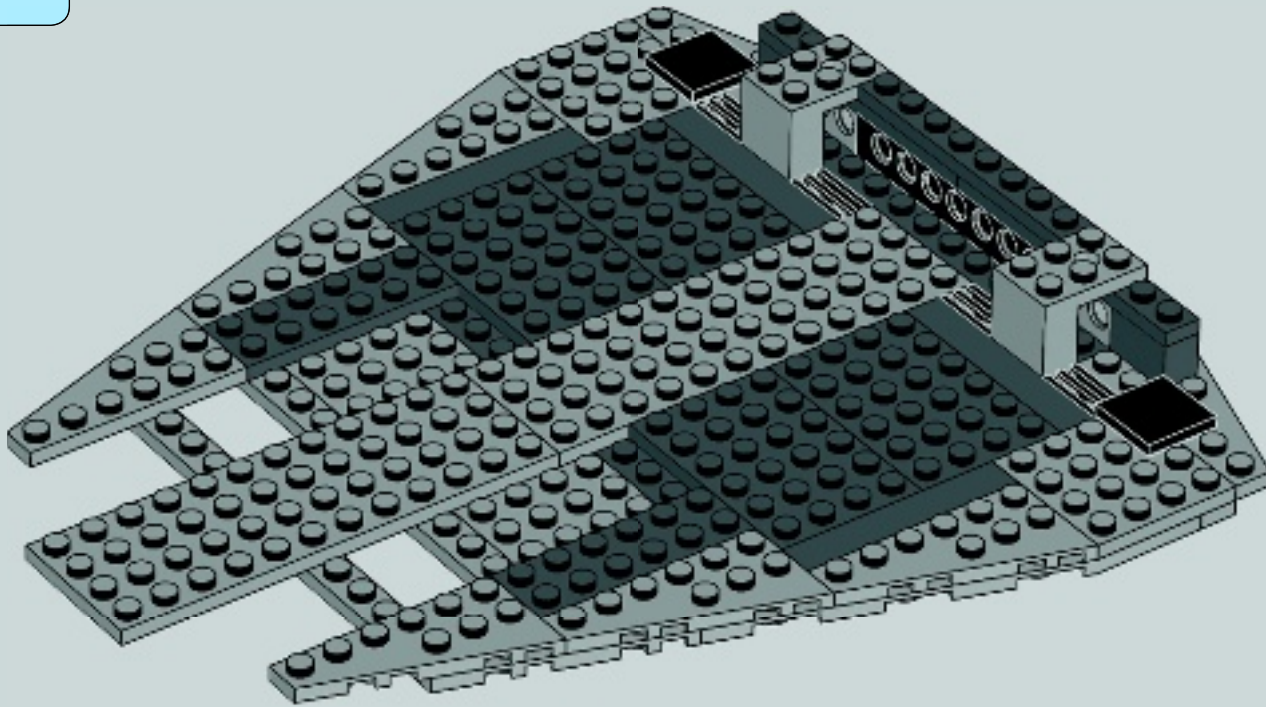

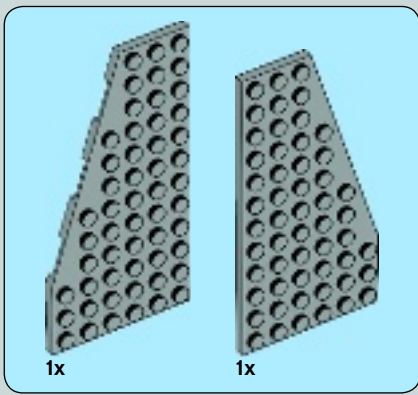

16

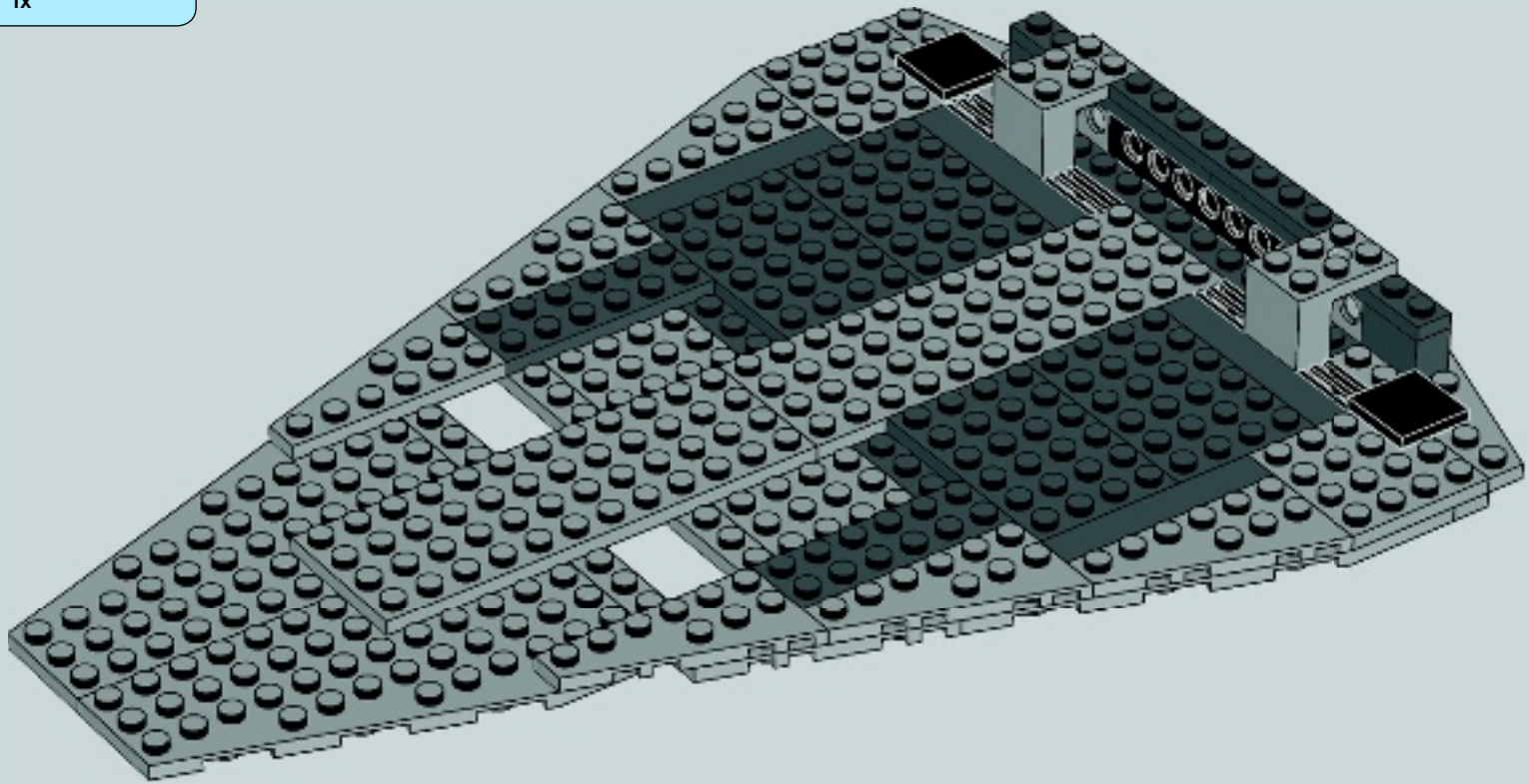



17

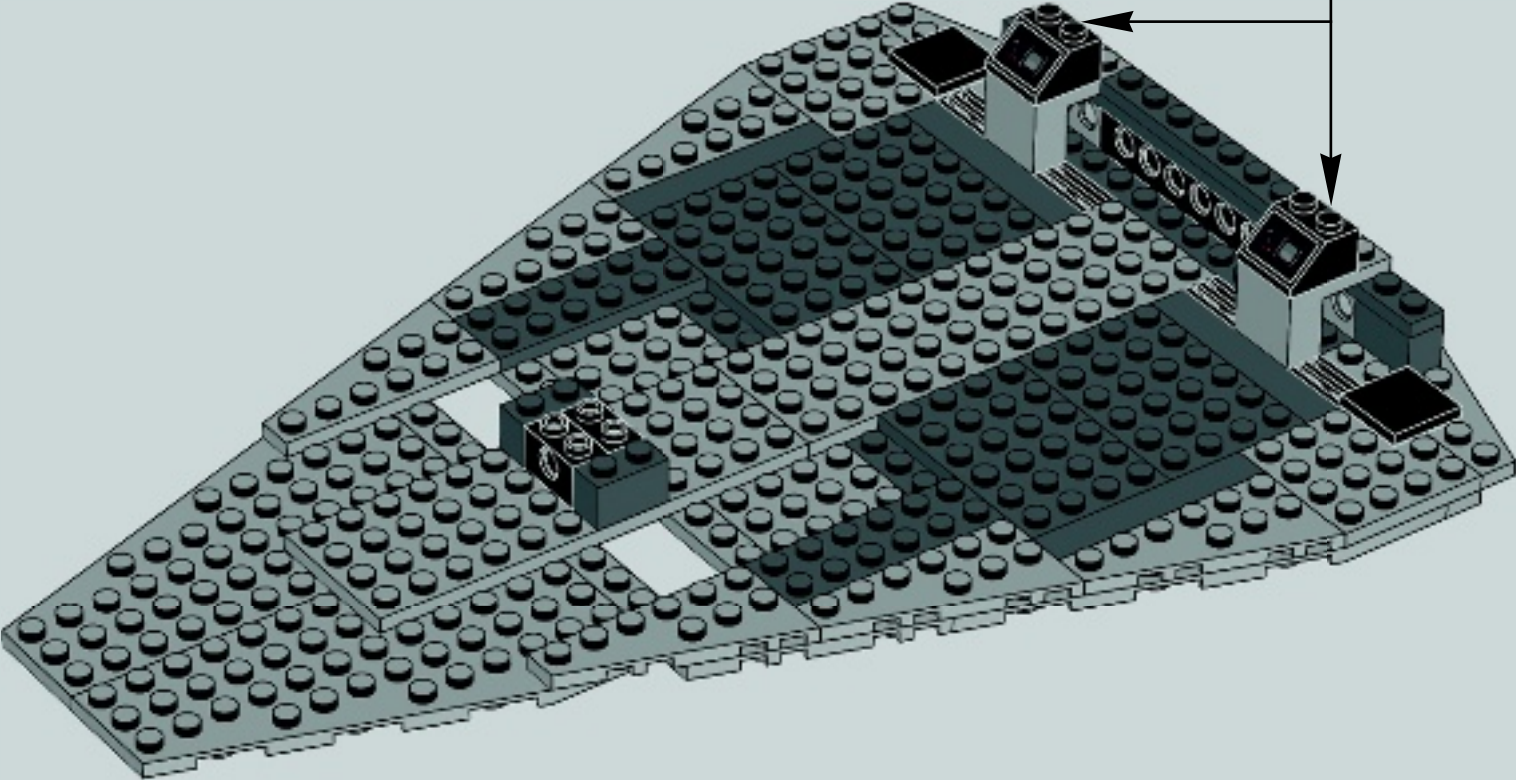
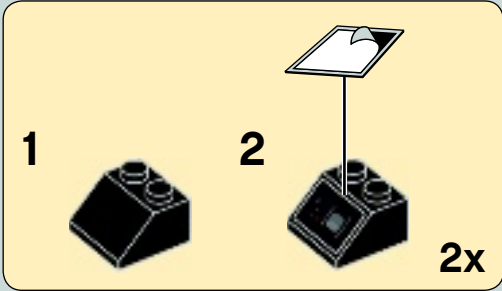

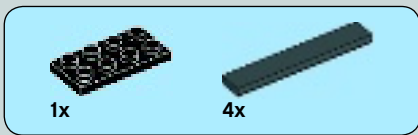

18

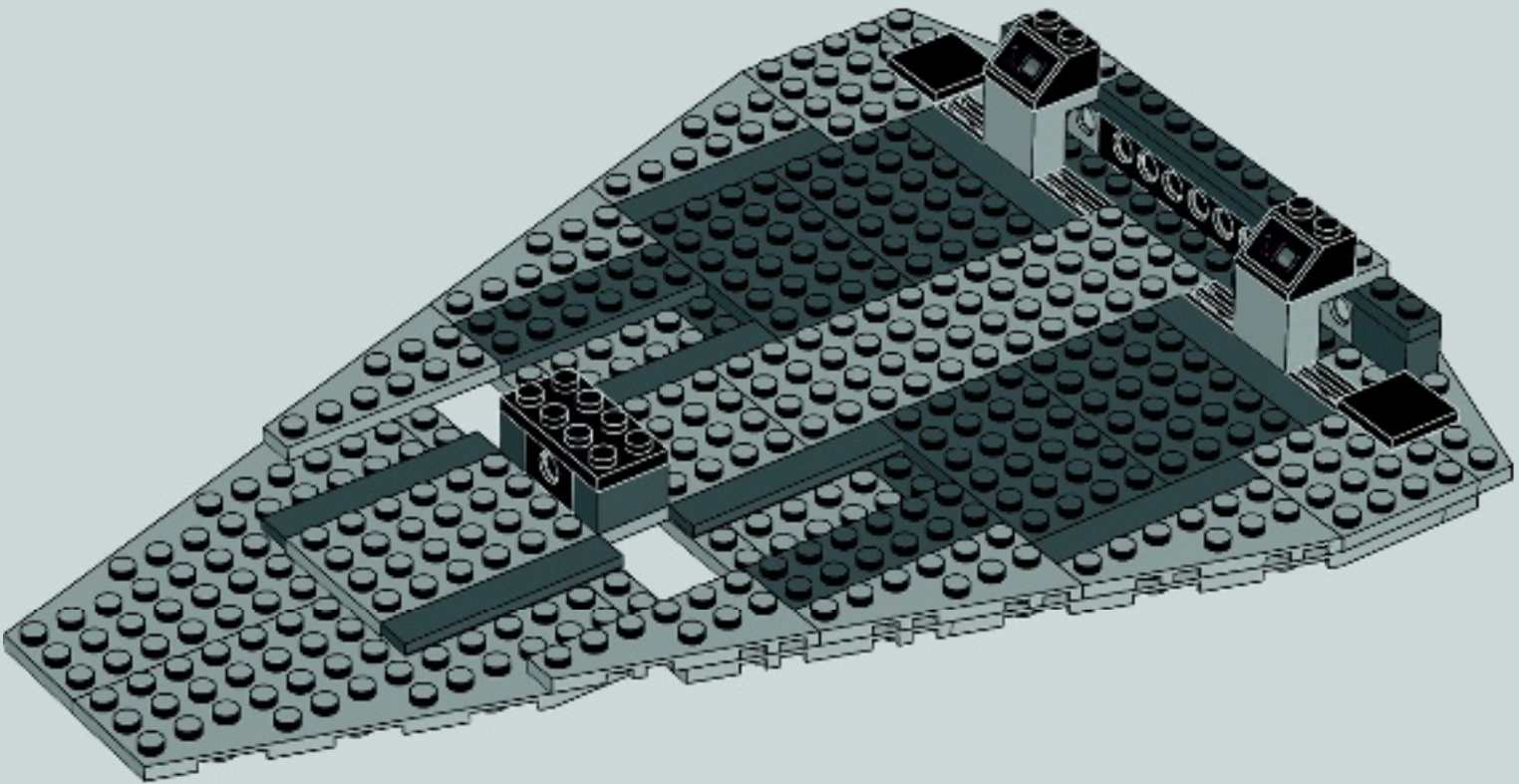

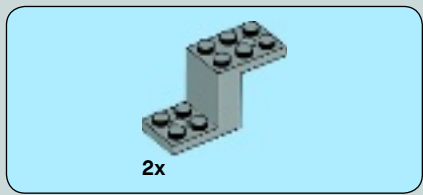

19

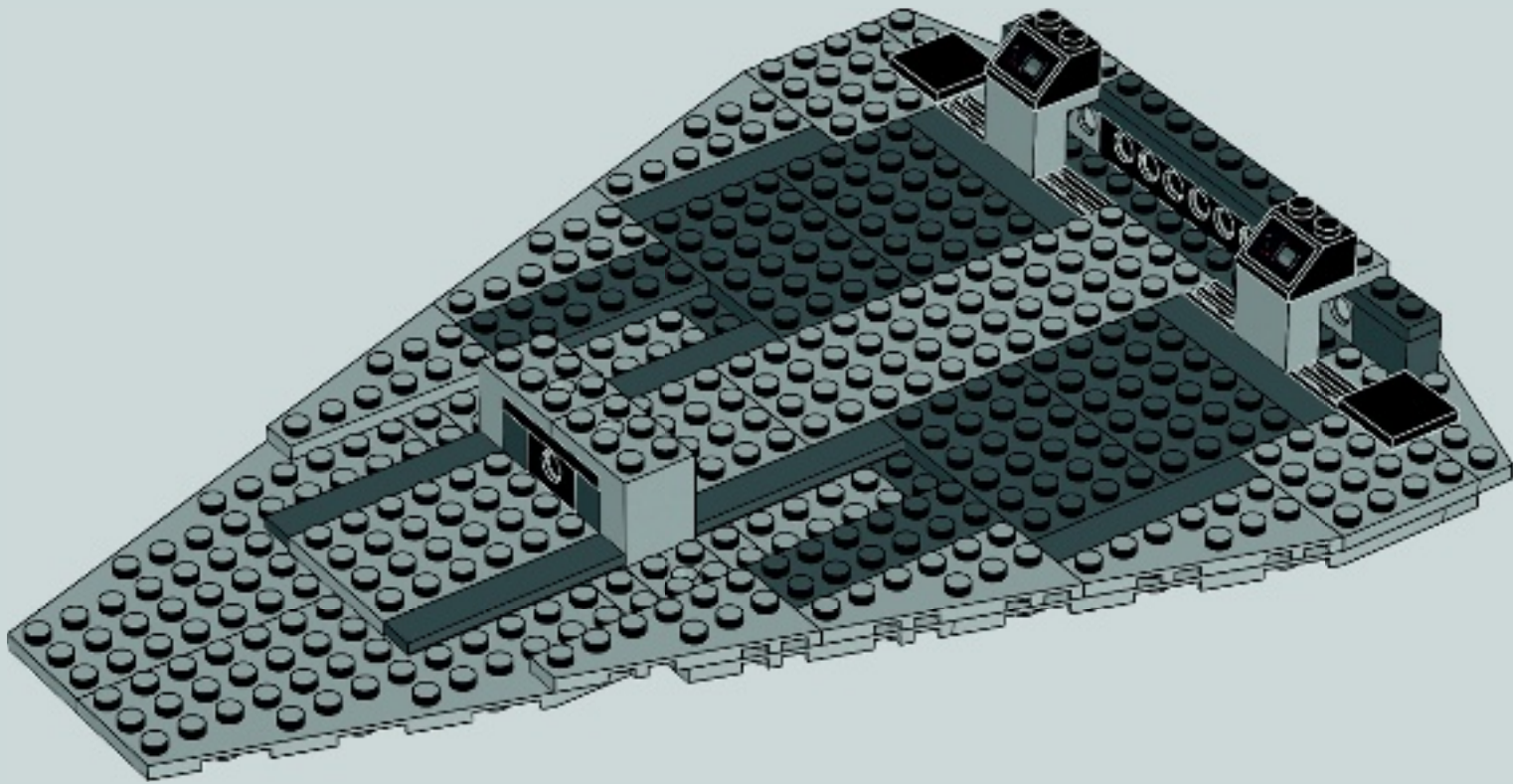

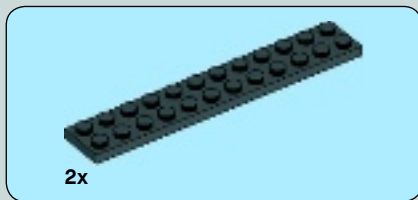

20

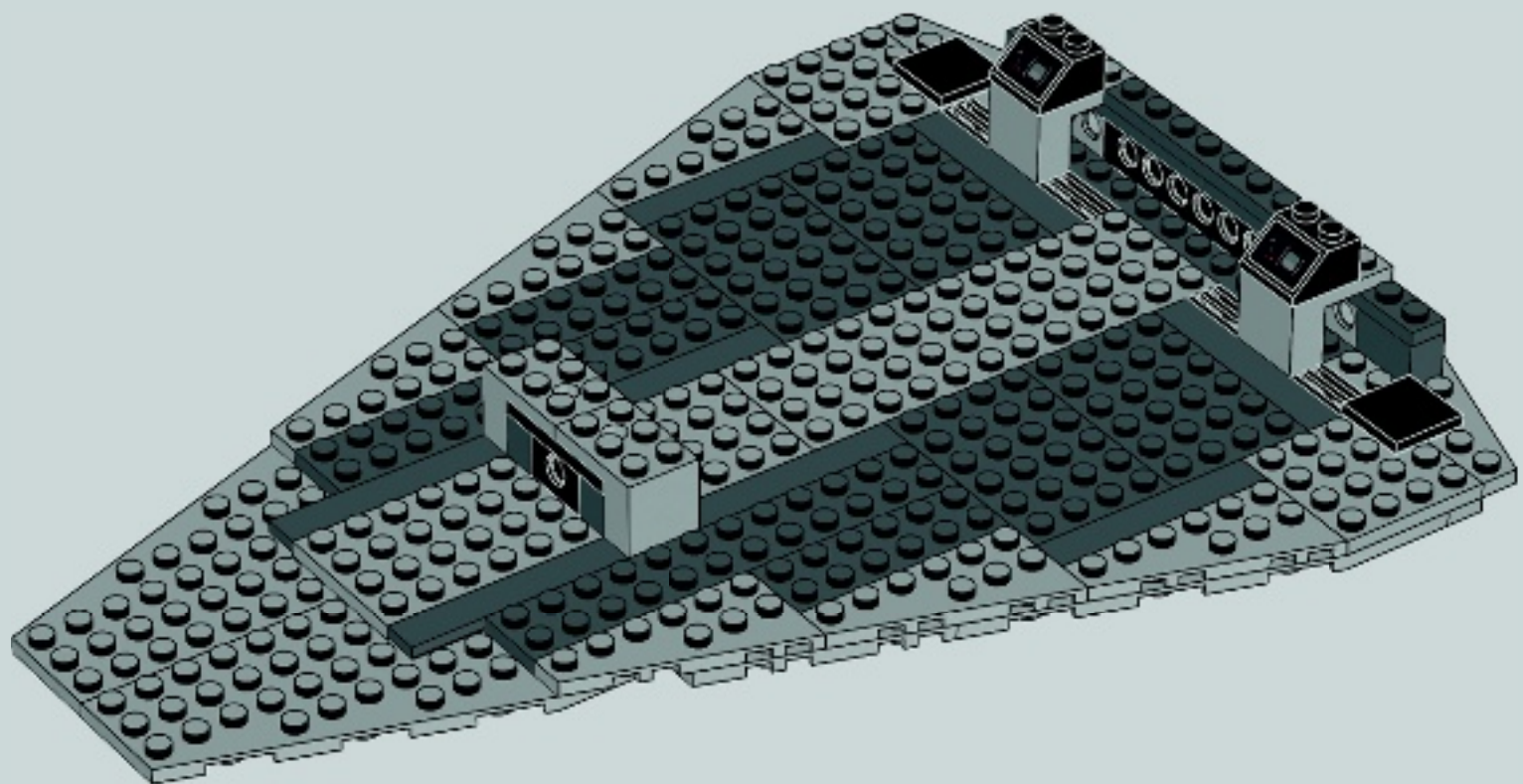

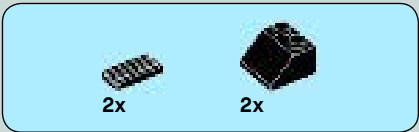

21

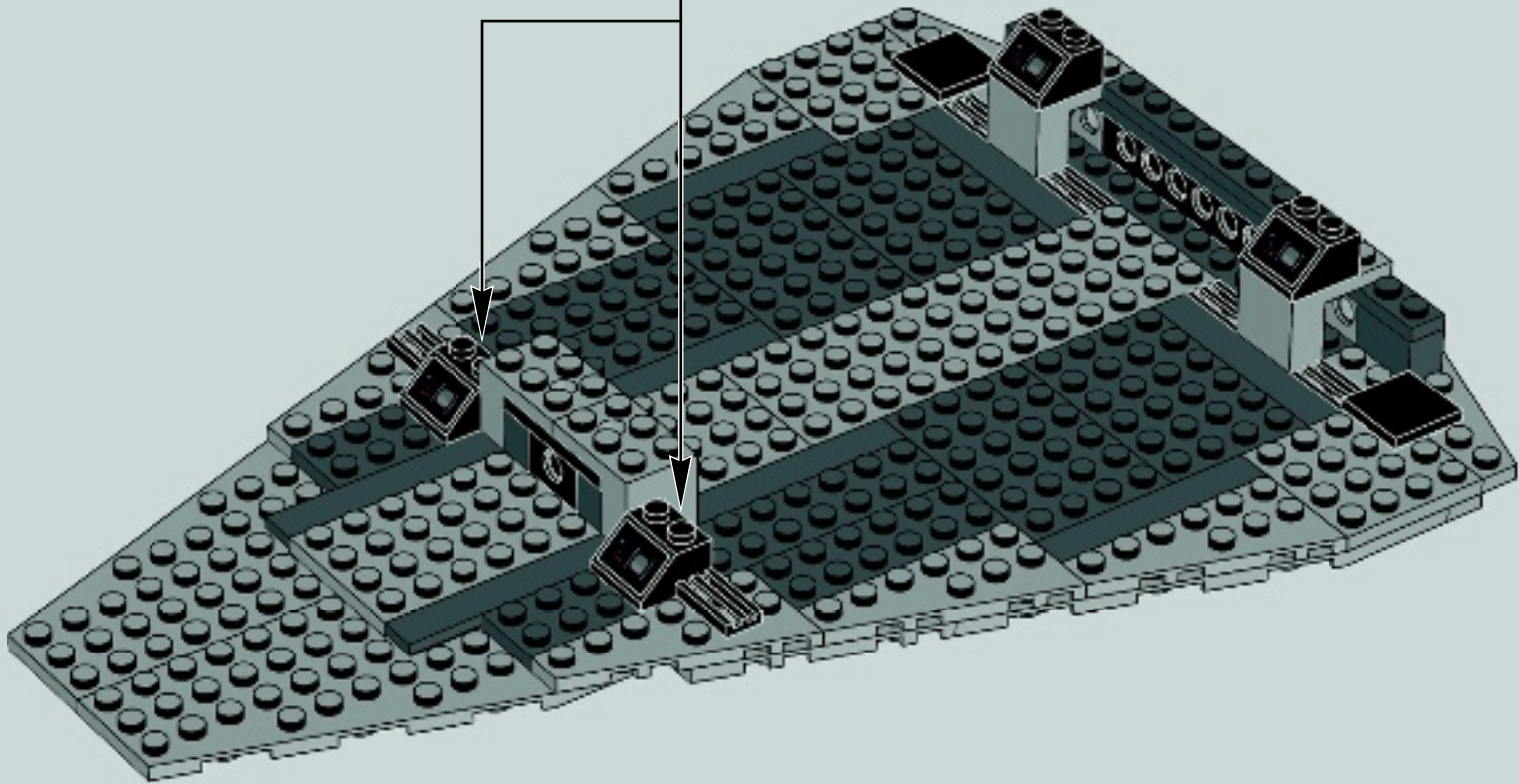
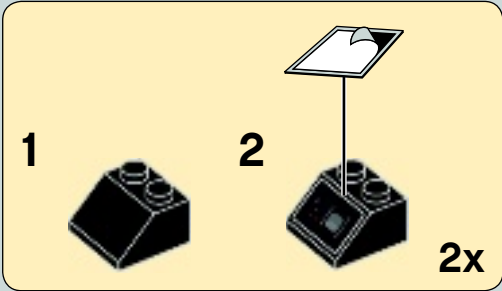

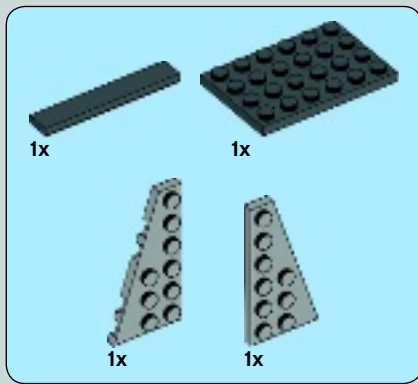

22

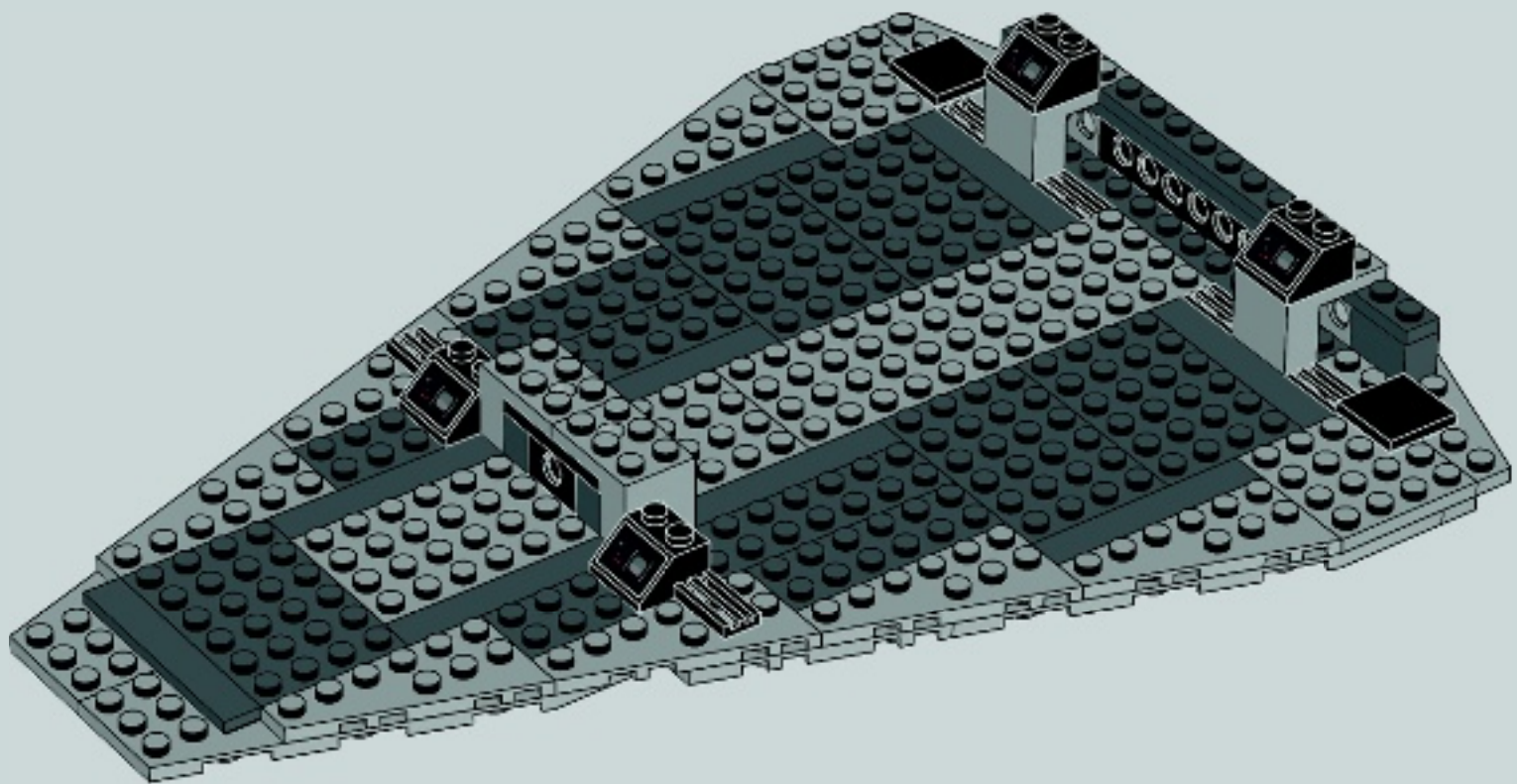

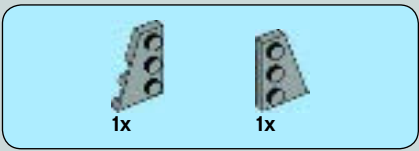

1

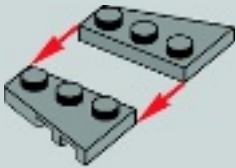

2

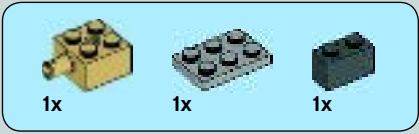
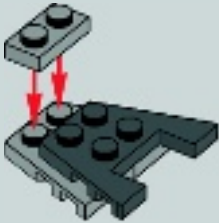

3

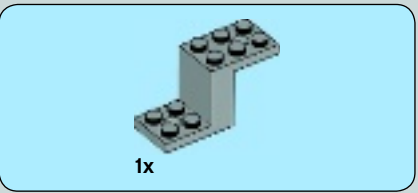
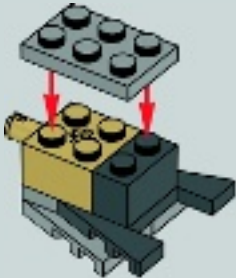

4

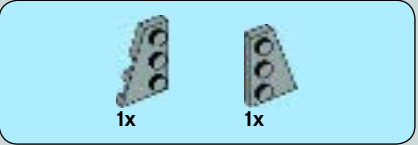
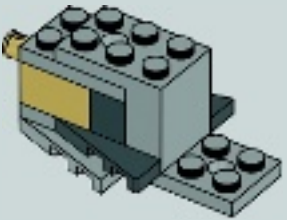

5

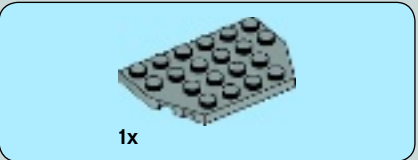
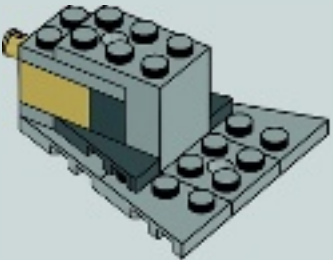

6

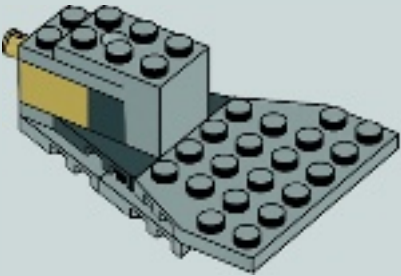

23

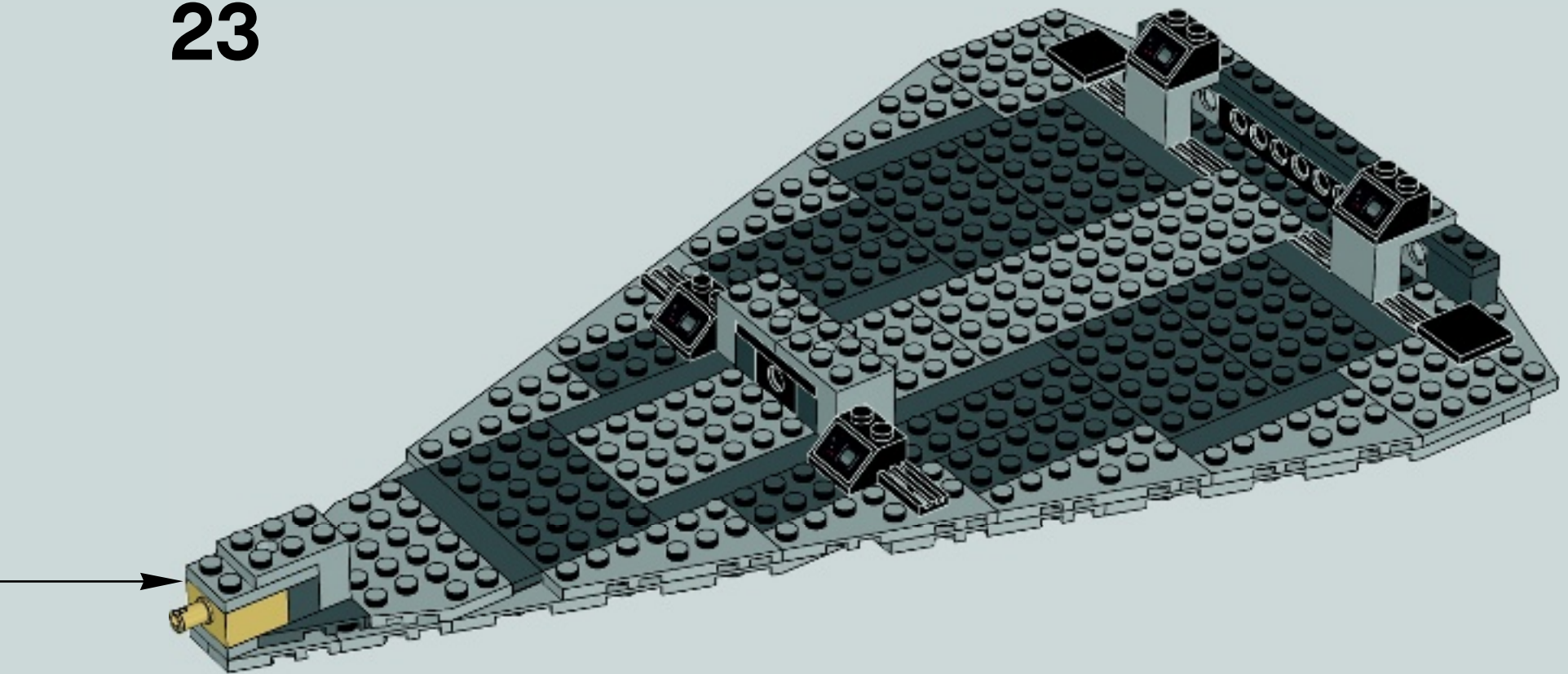

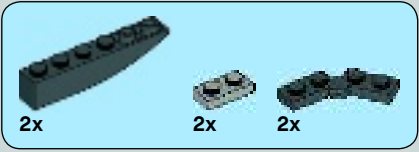
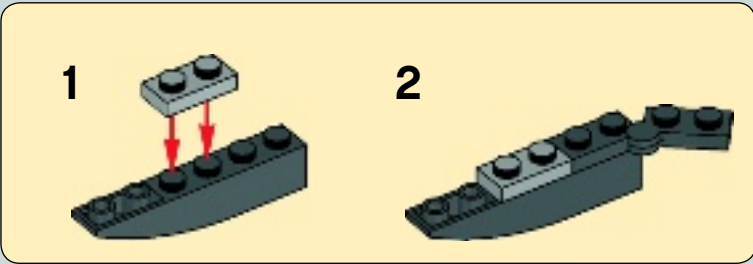
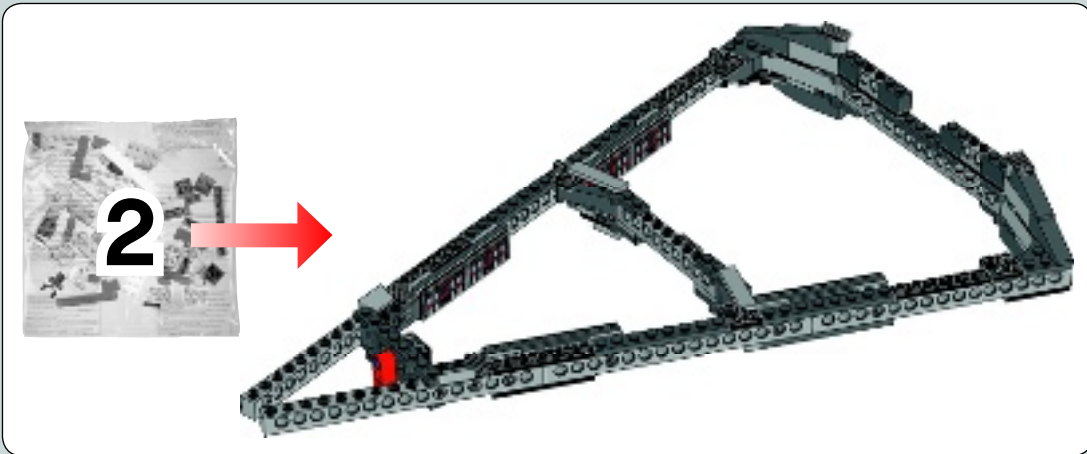

24

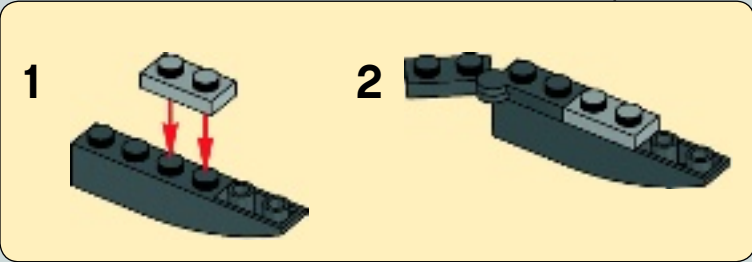
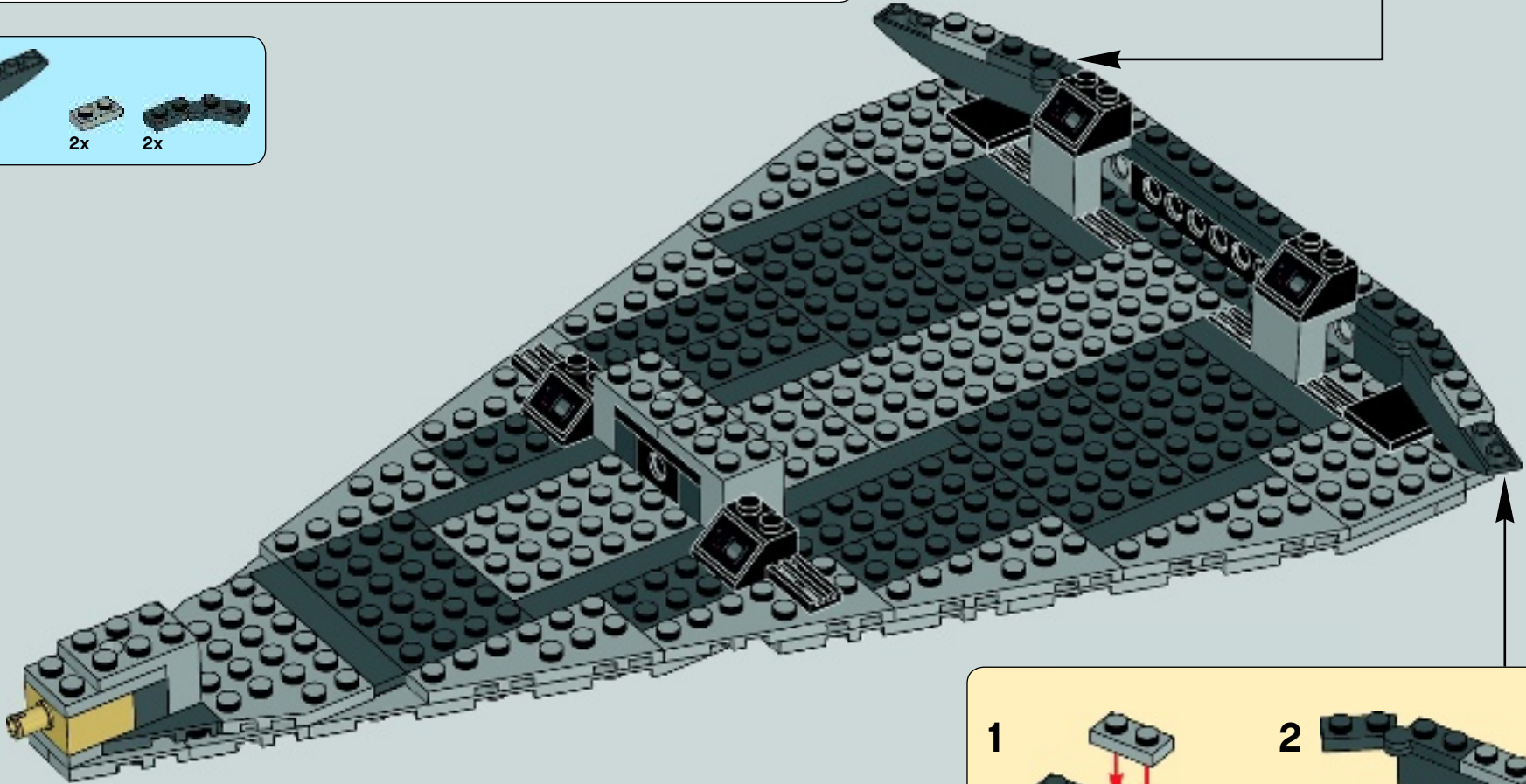

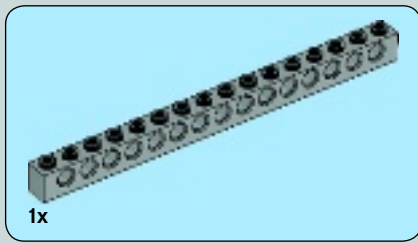

25

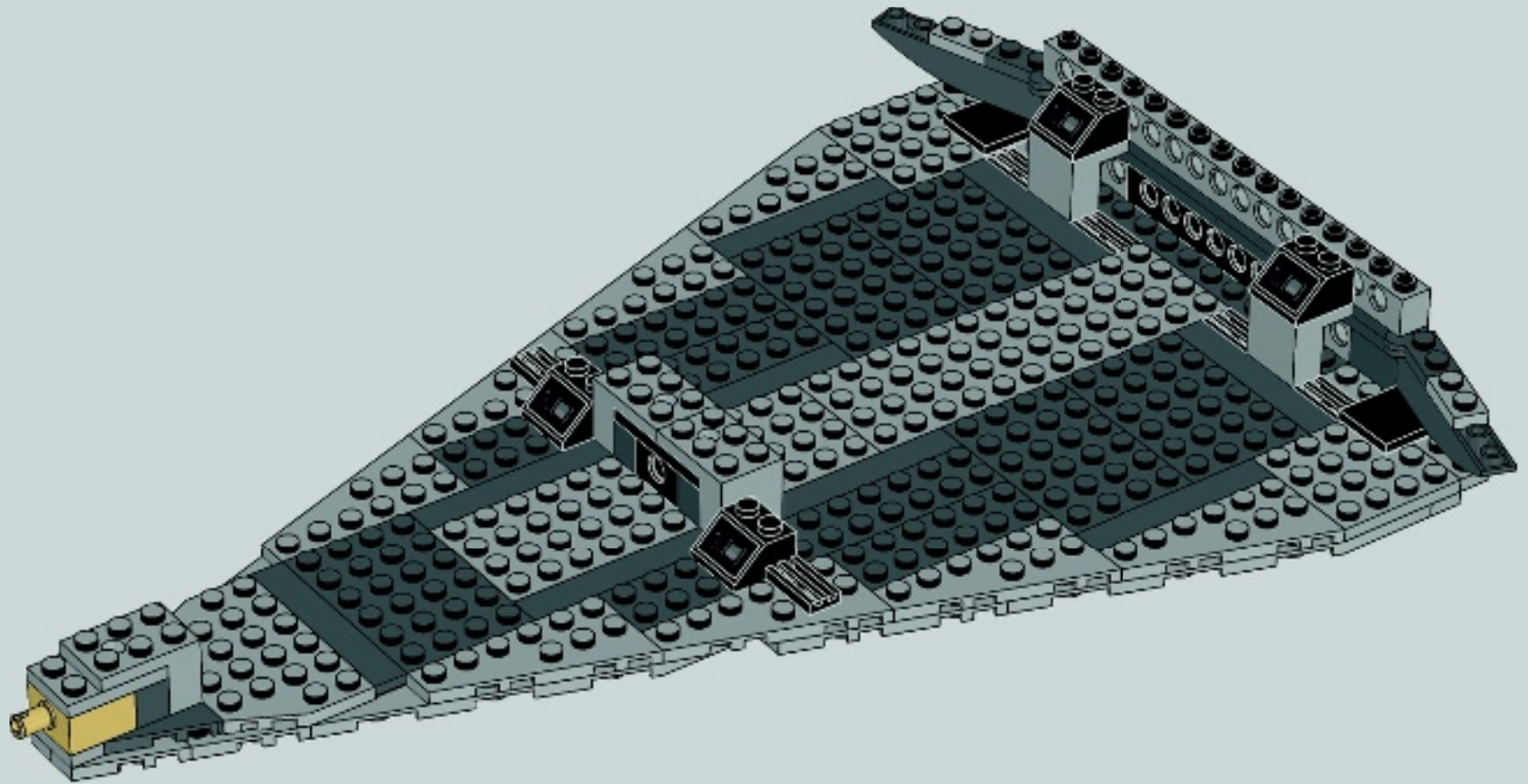

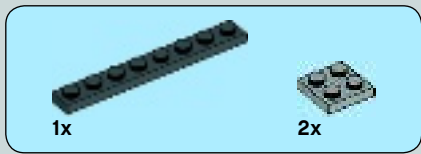

26

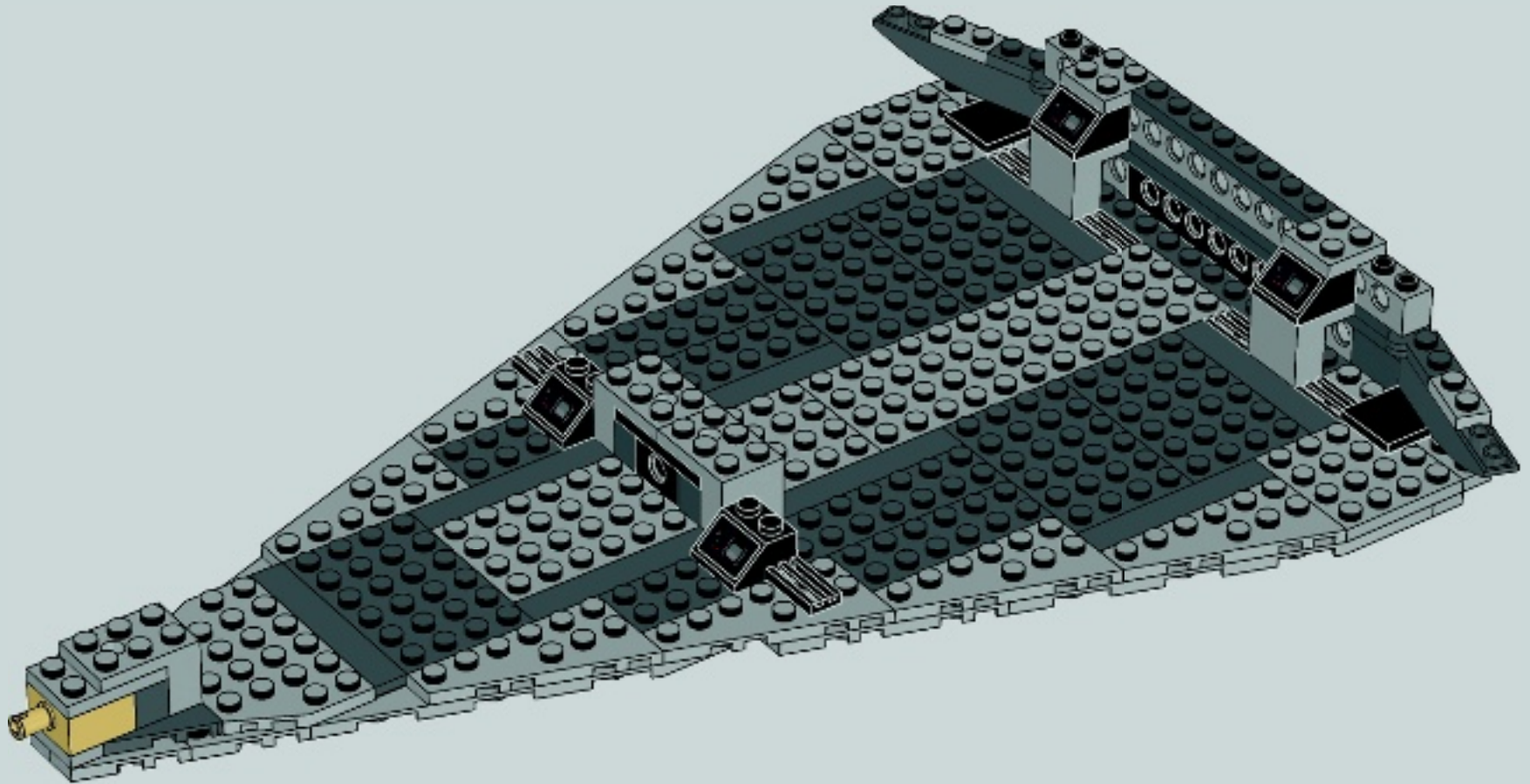

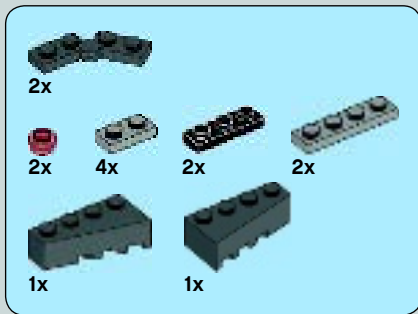

27

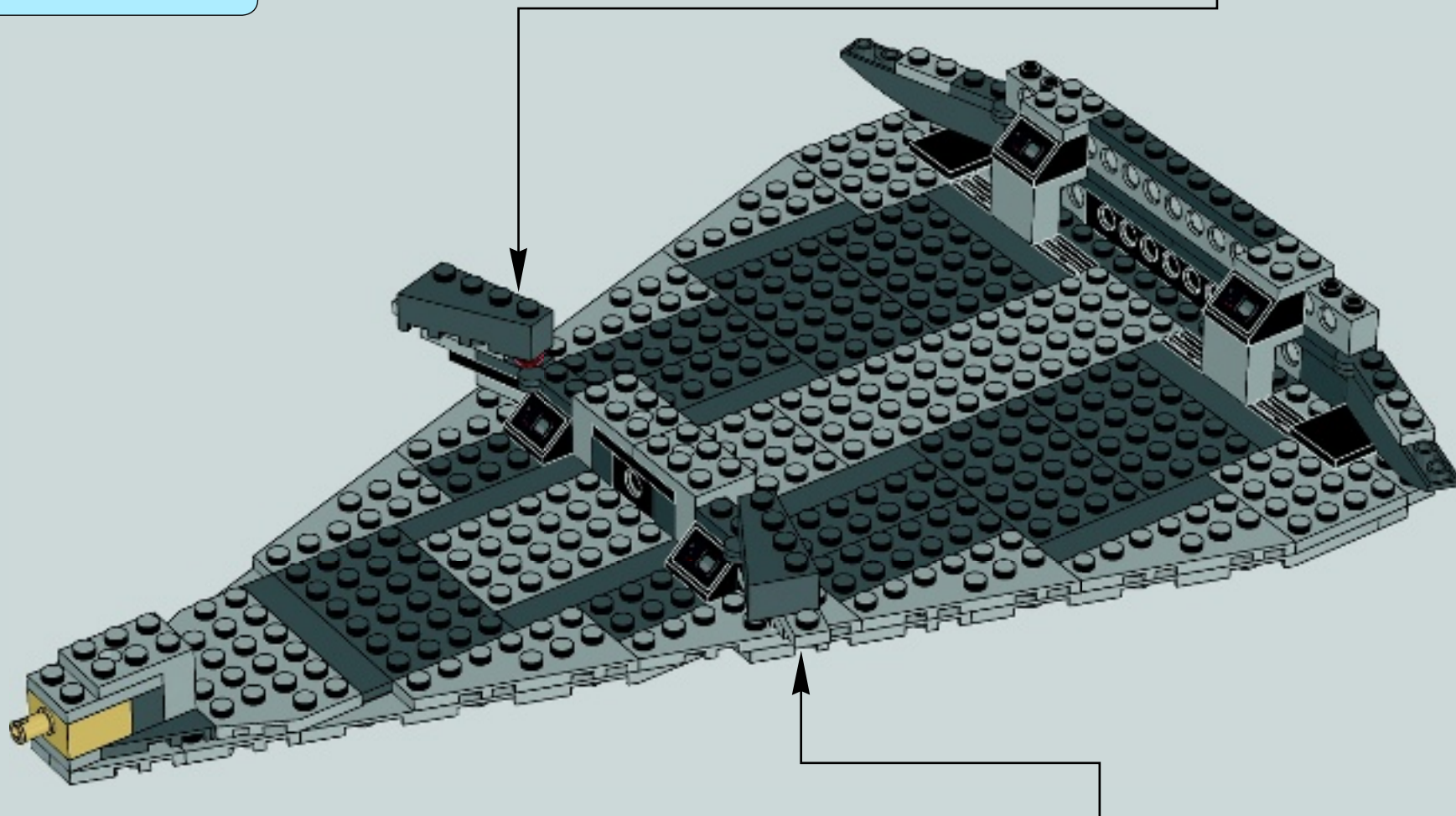
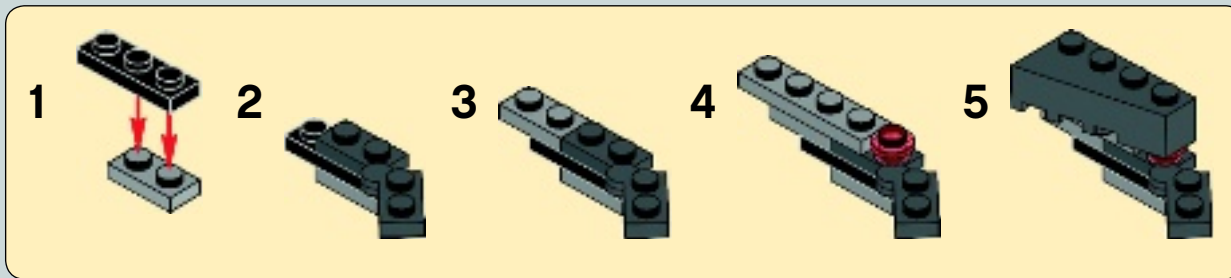

1x 2x

28

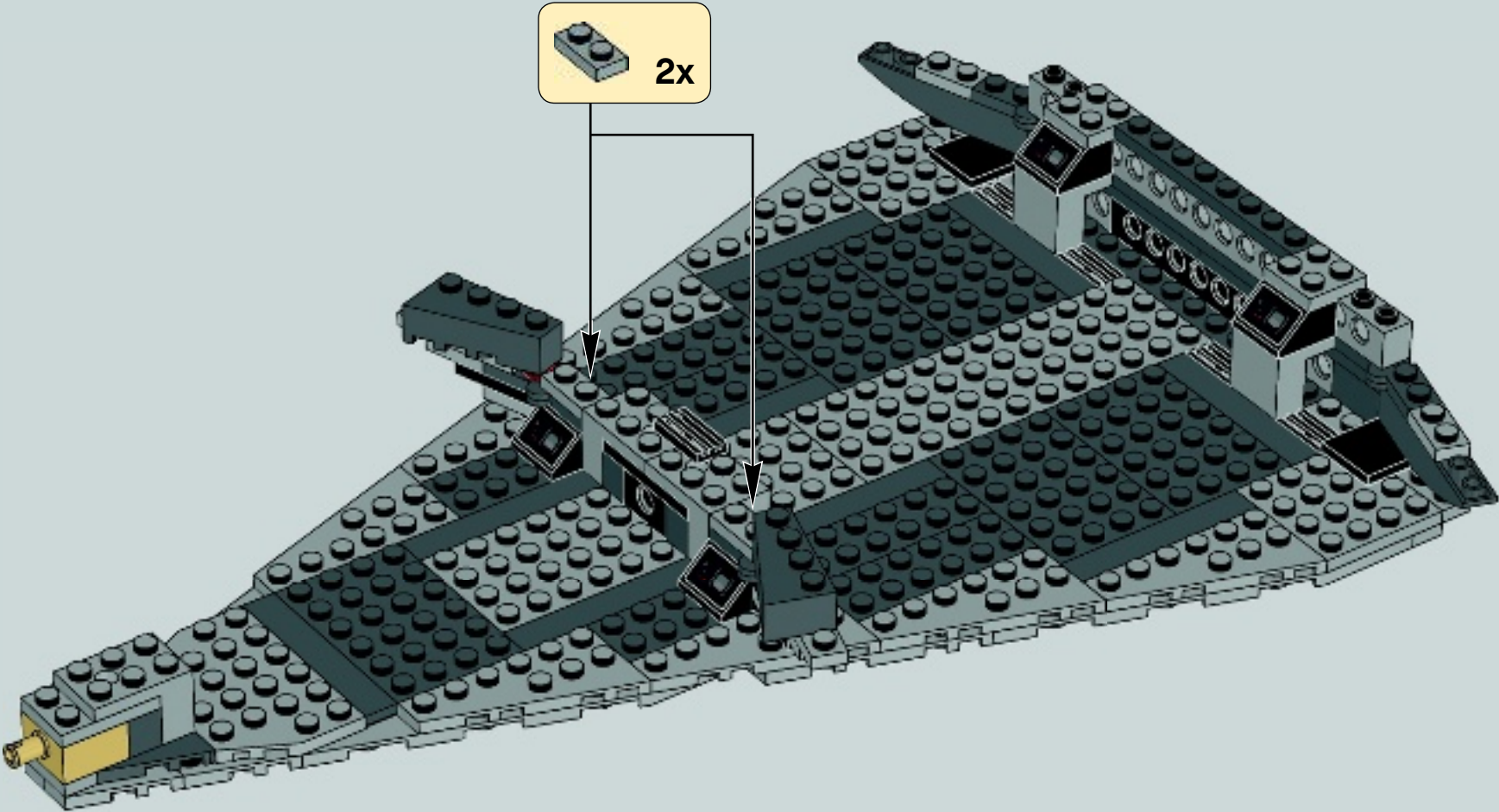

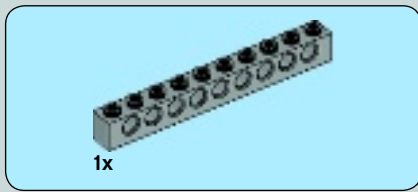

29

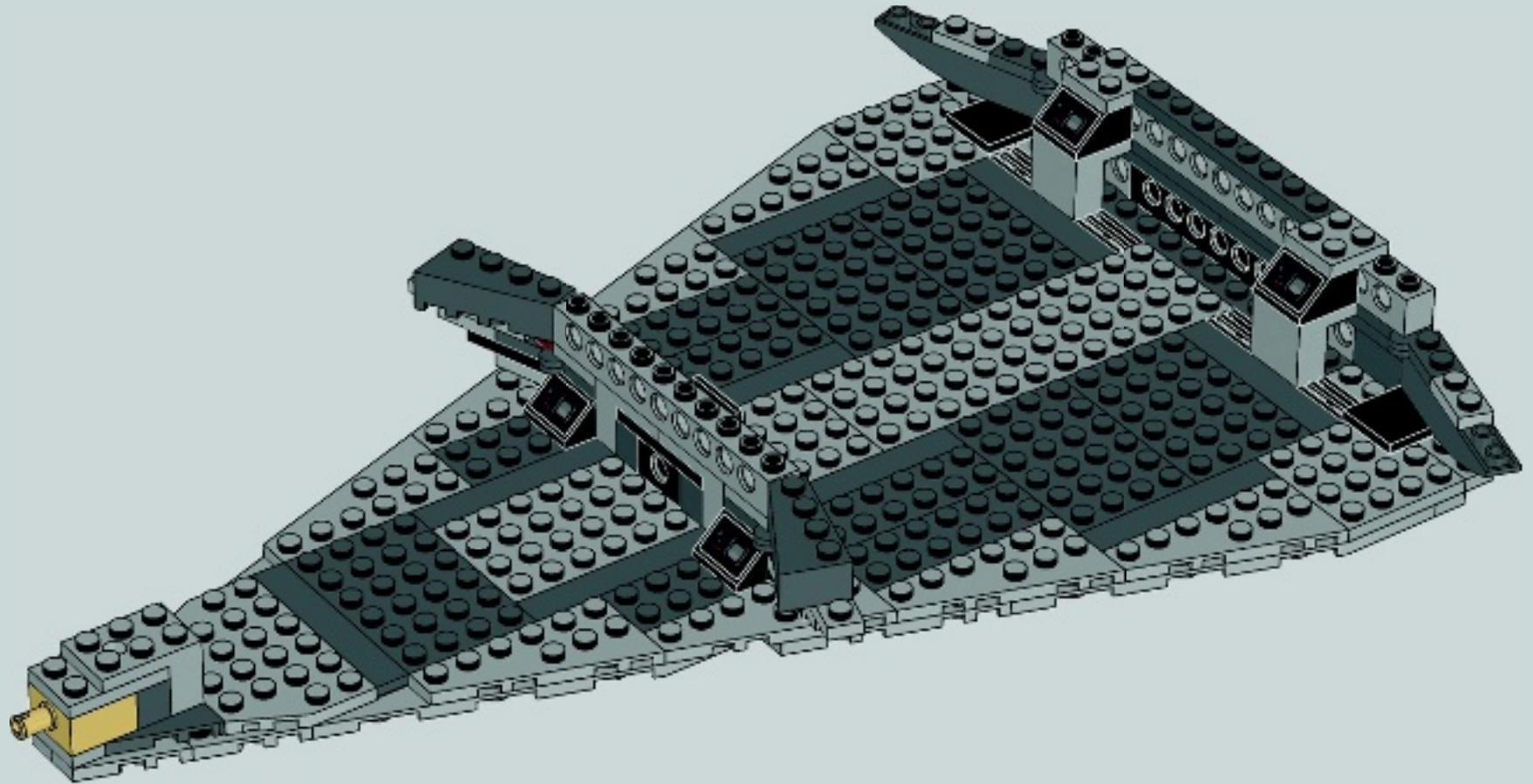

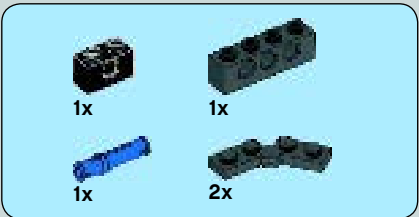

30

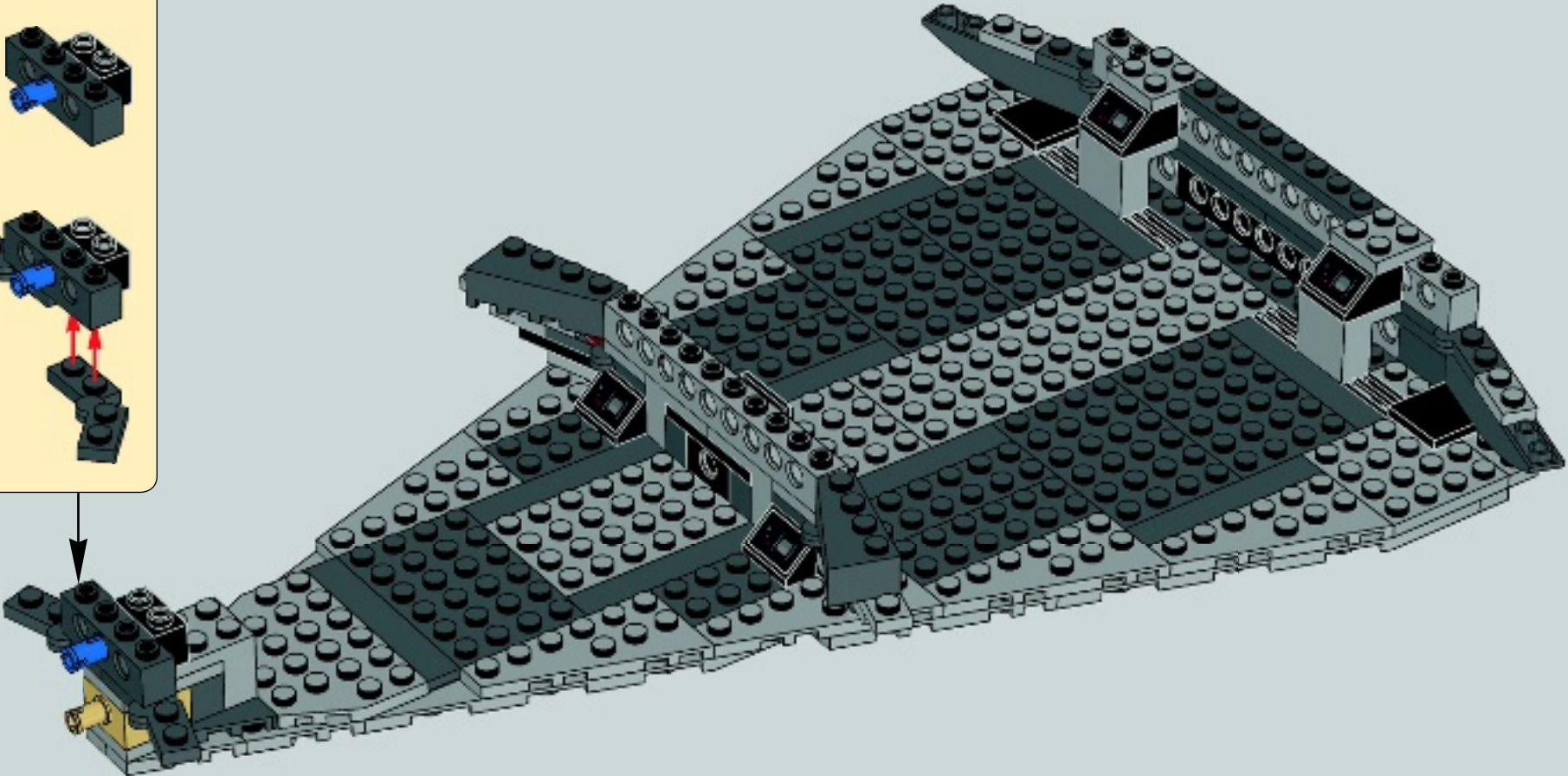
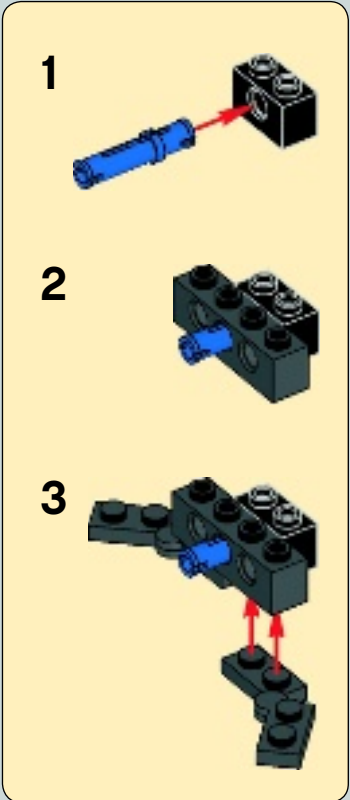

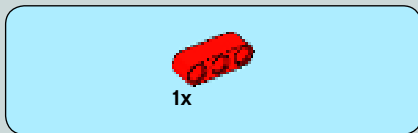

31

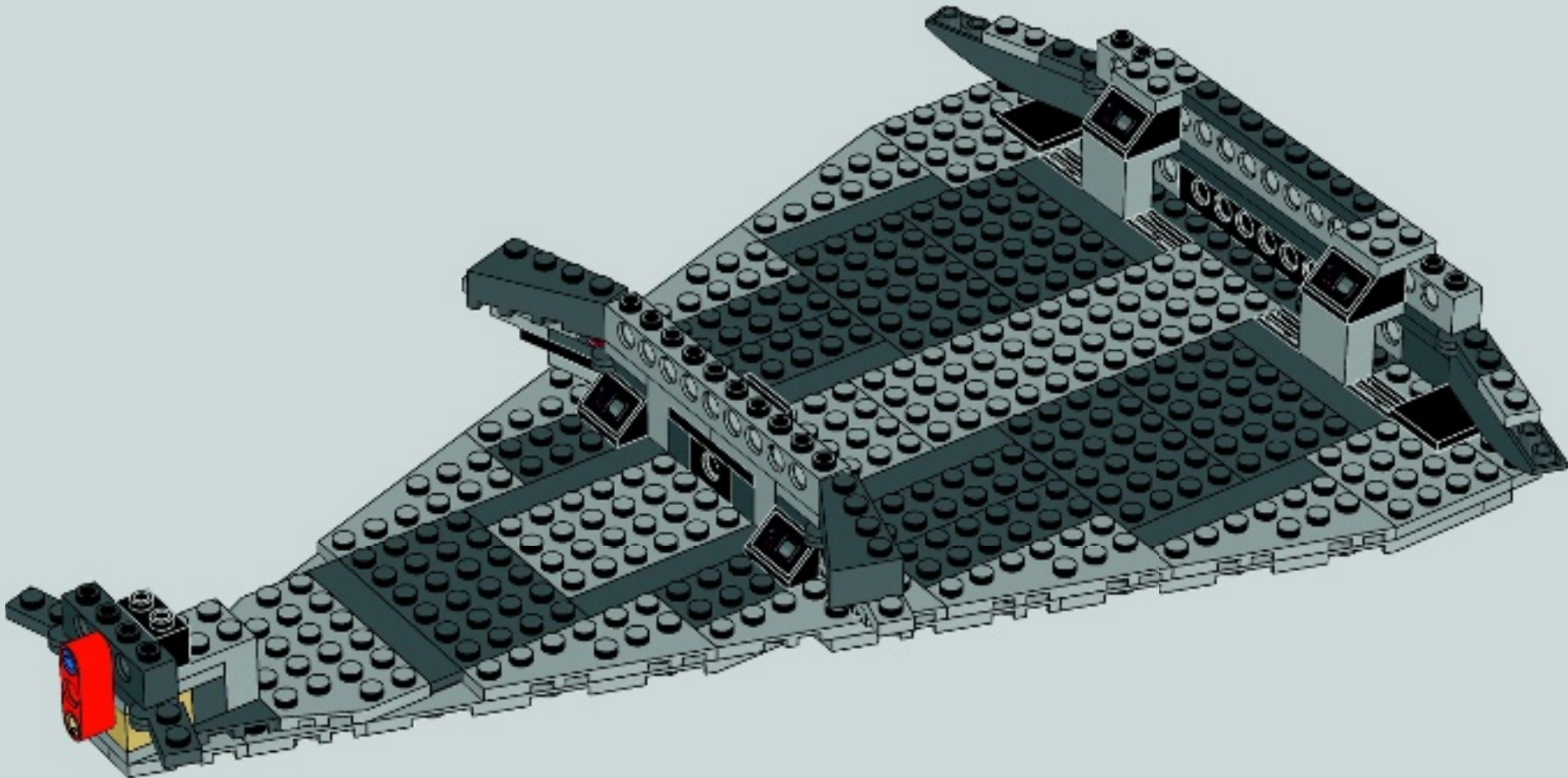

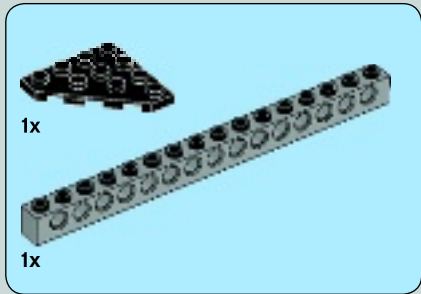

1

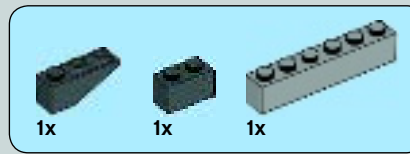
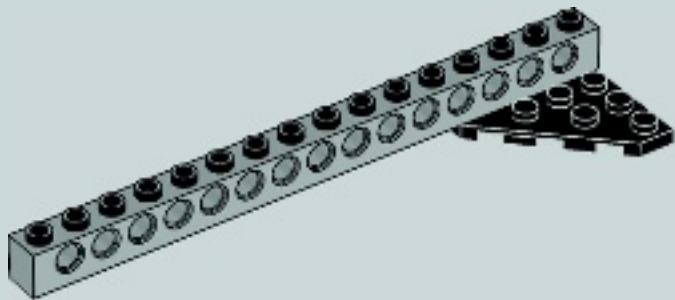

2

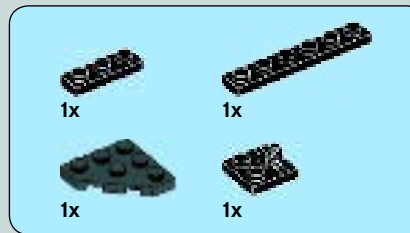
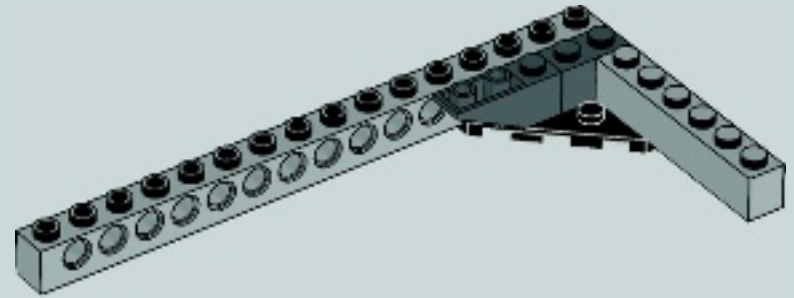

3

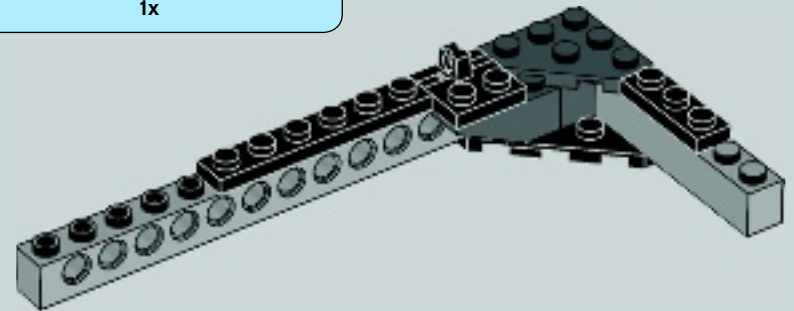

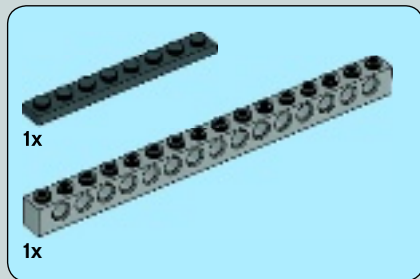

4

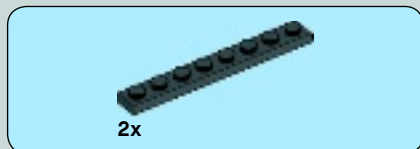
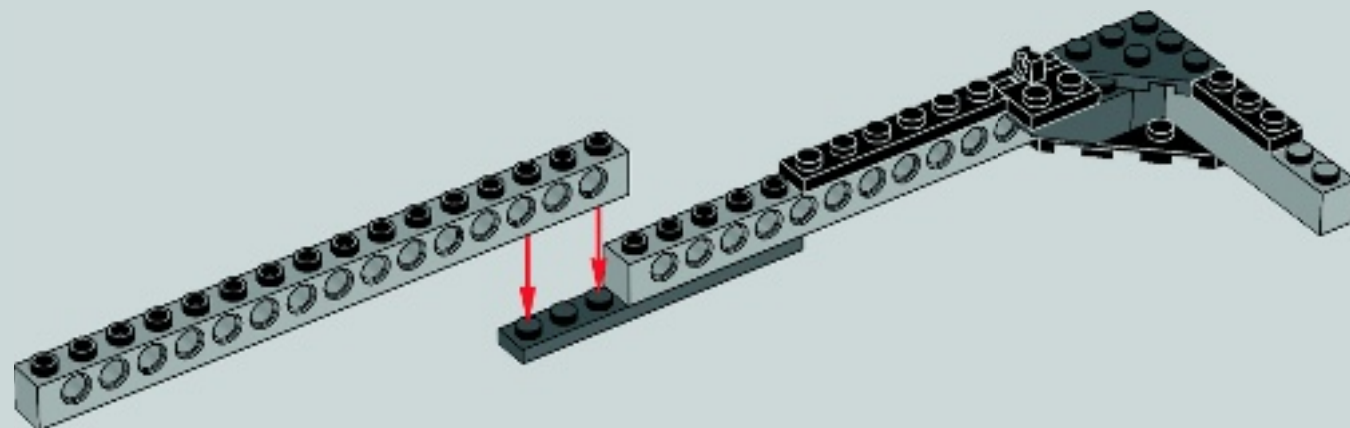

5

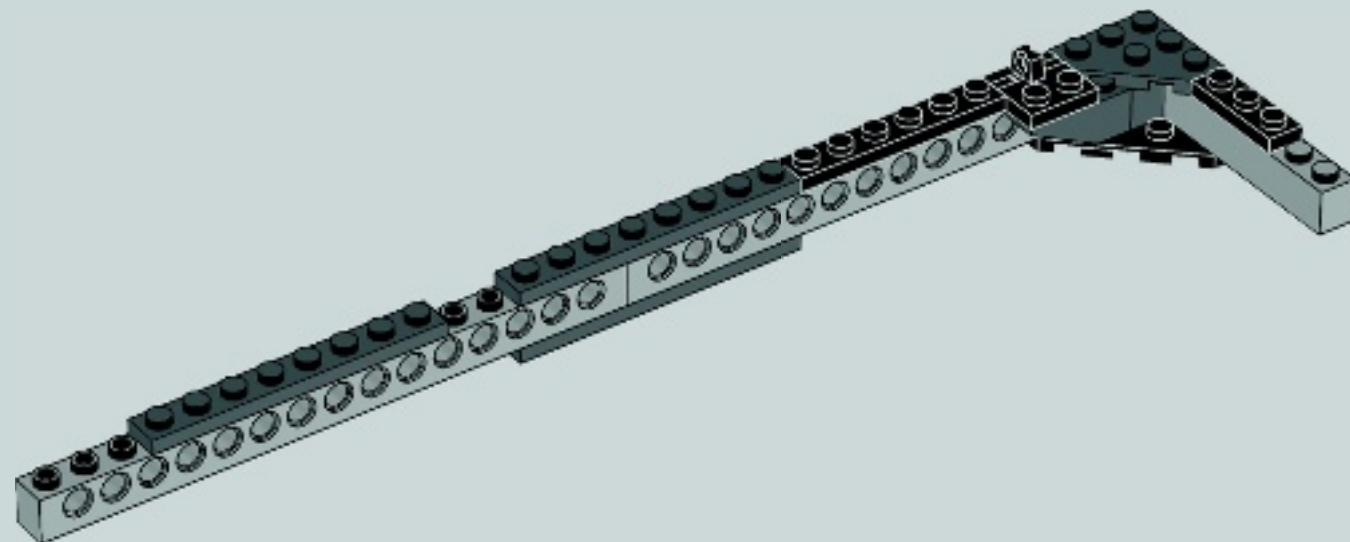

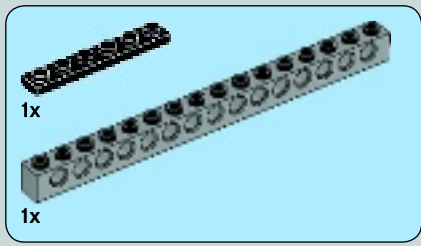

6

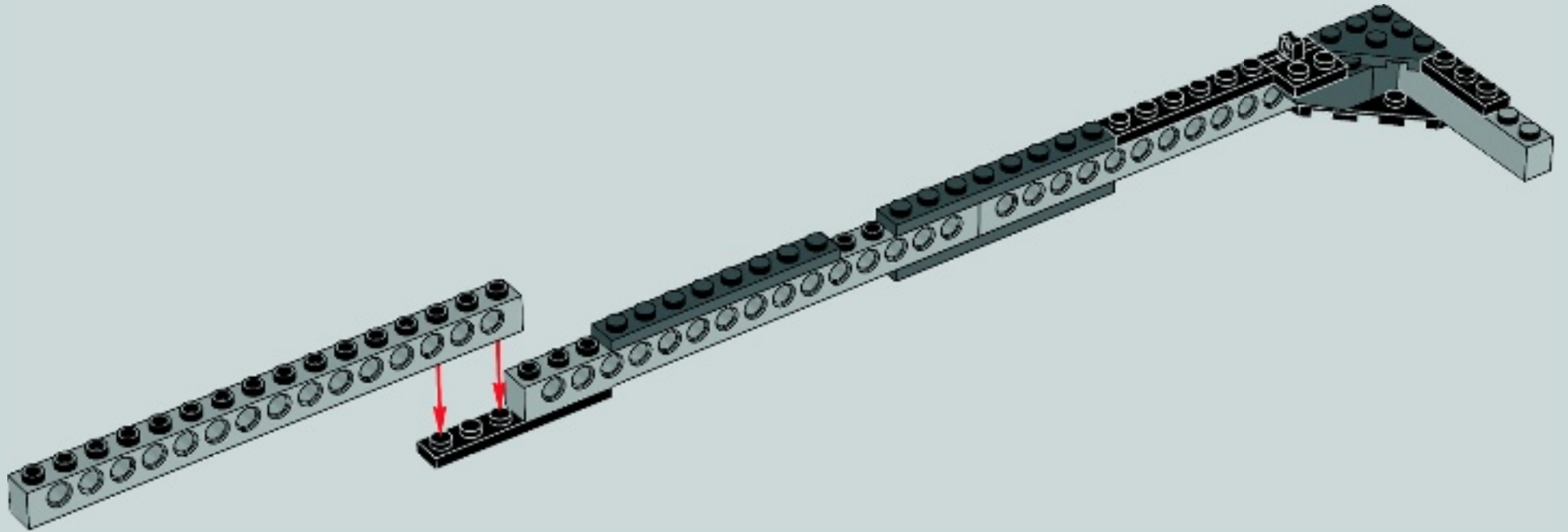

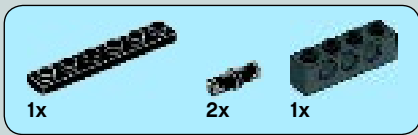

7

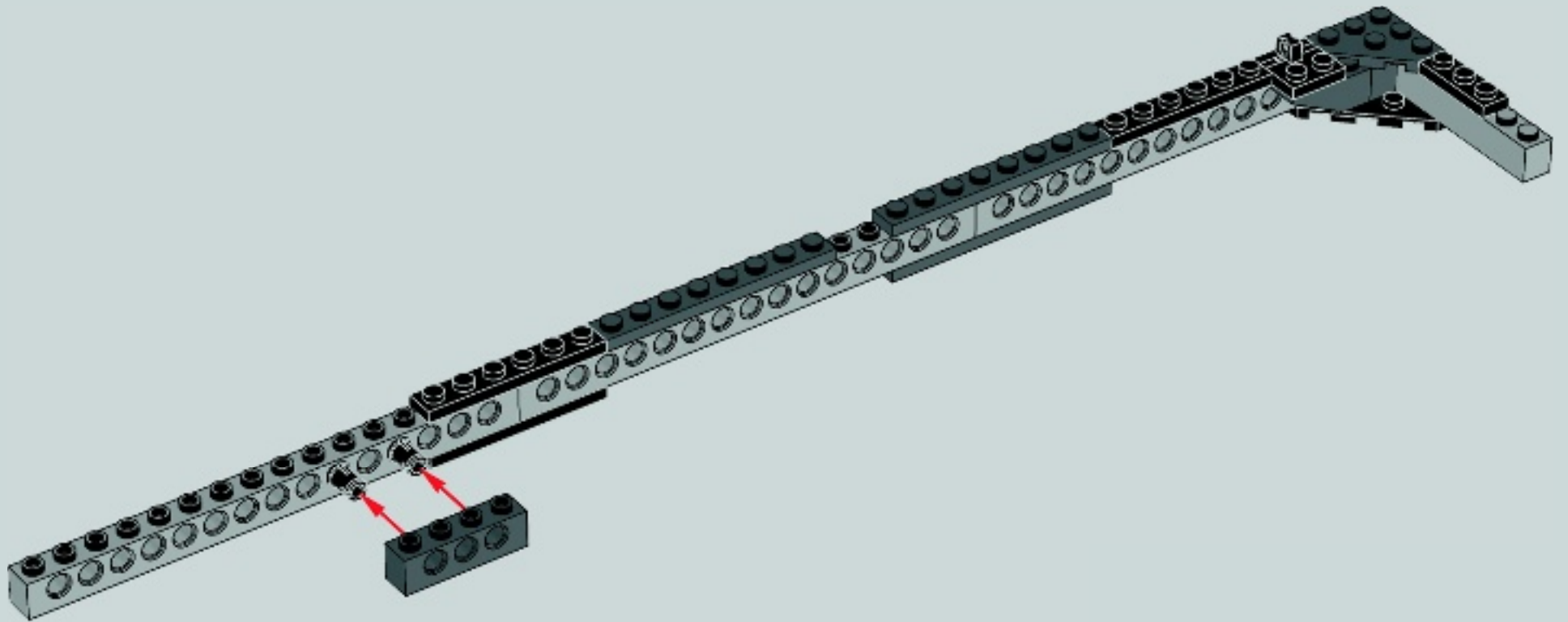



8

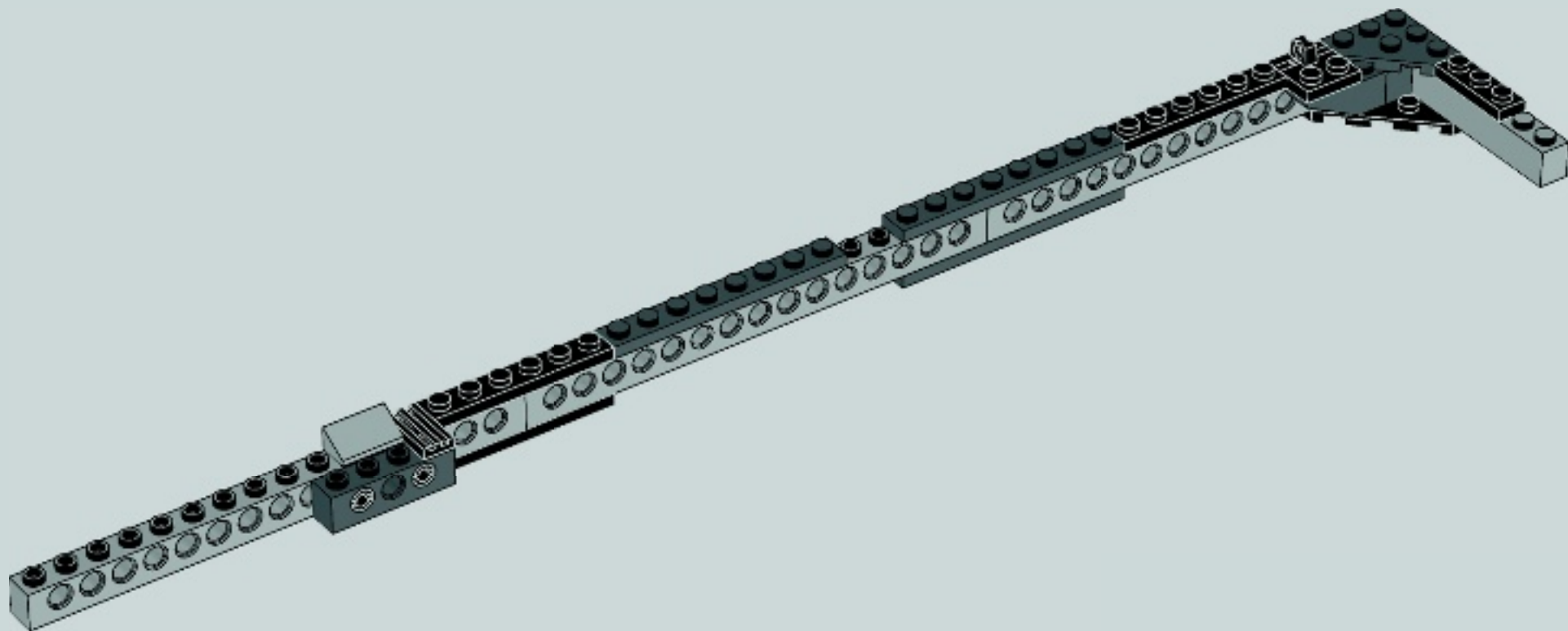

32

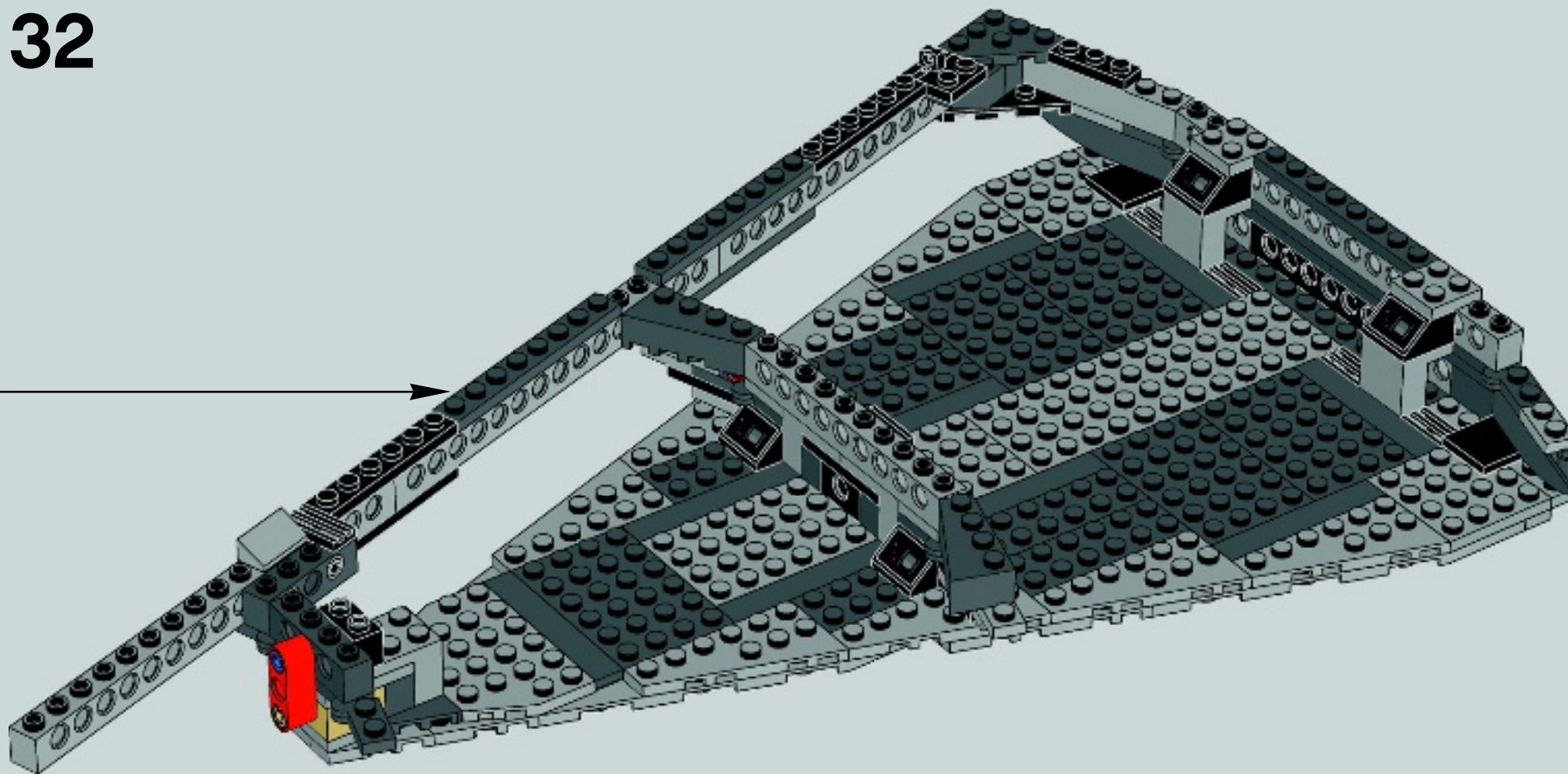

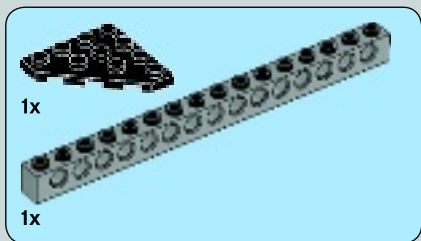

1

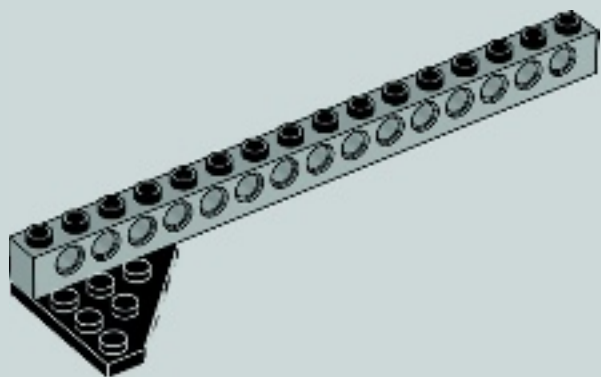

2

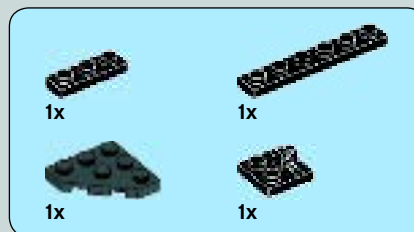
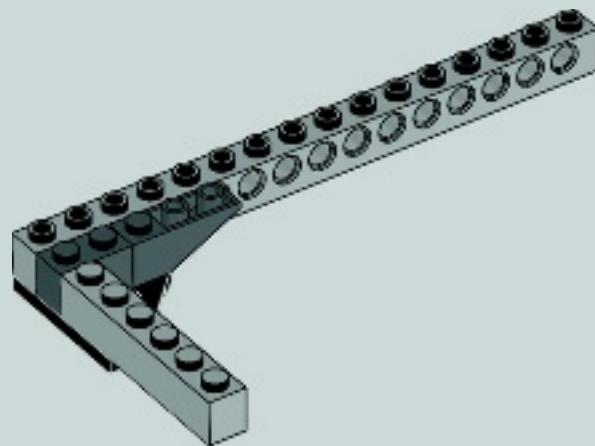

3

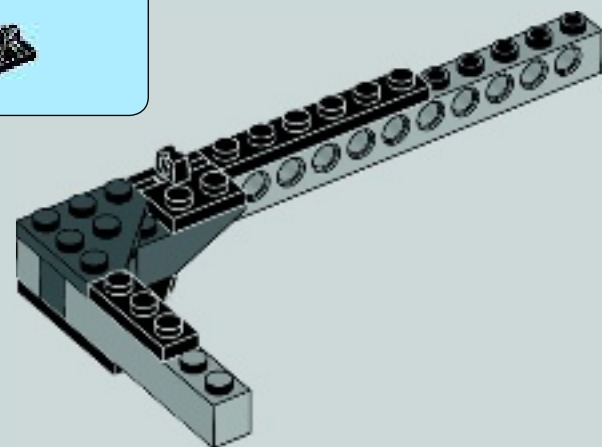

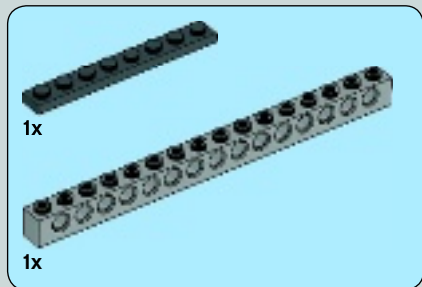

4

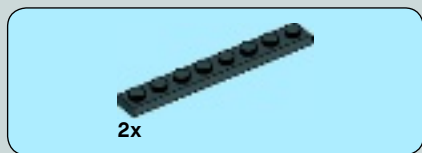
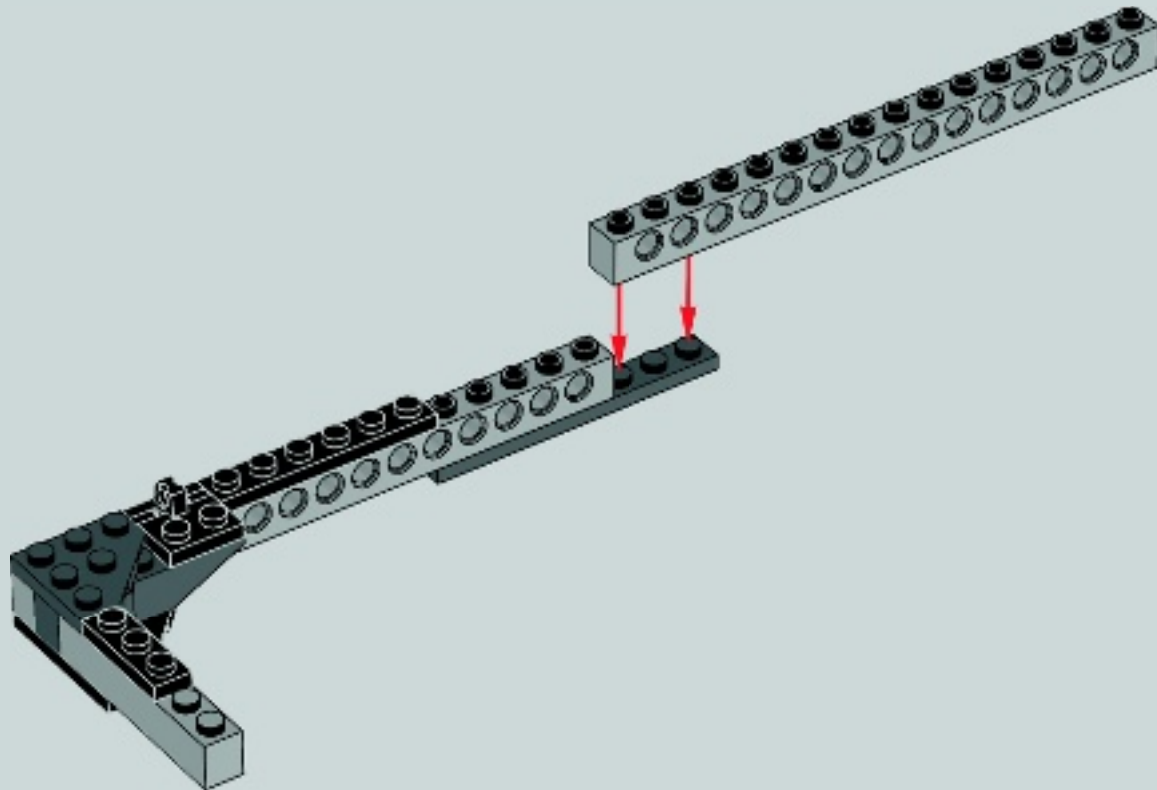

5

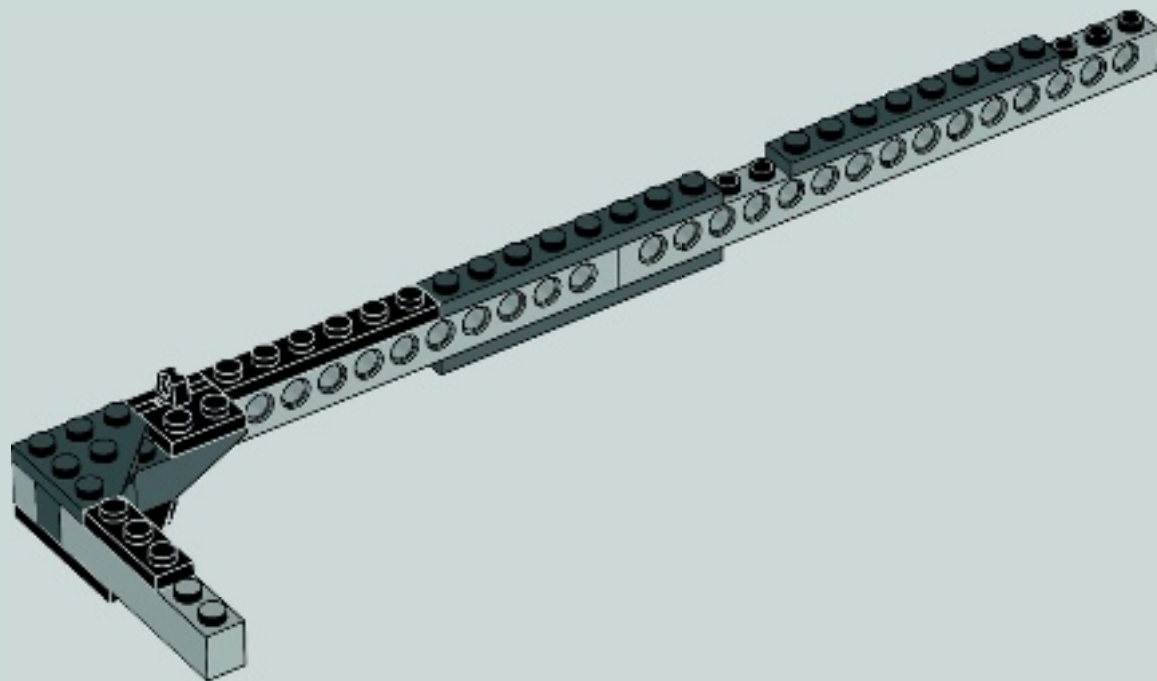

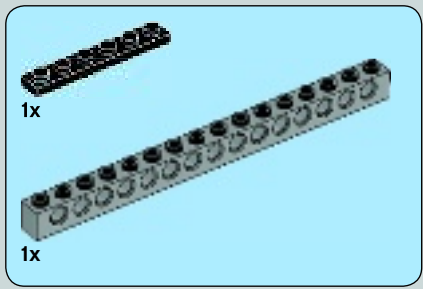

6

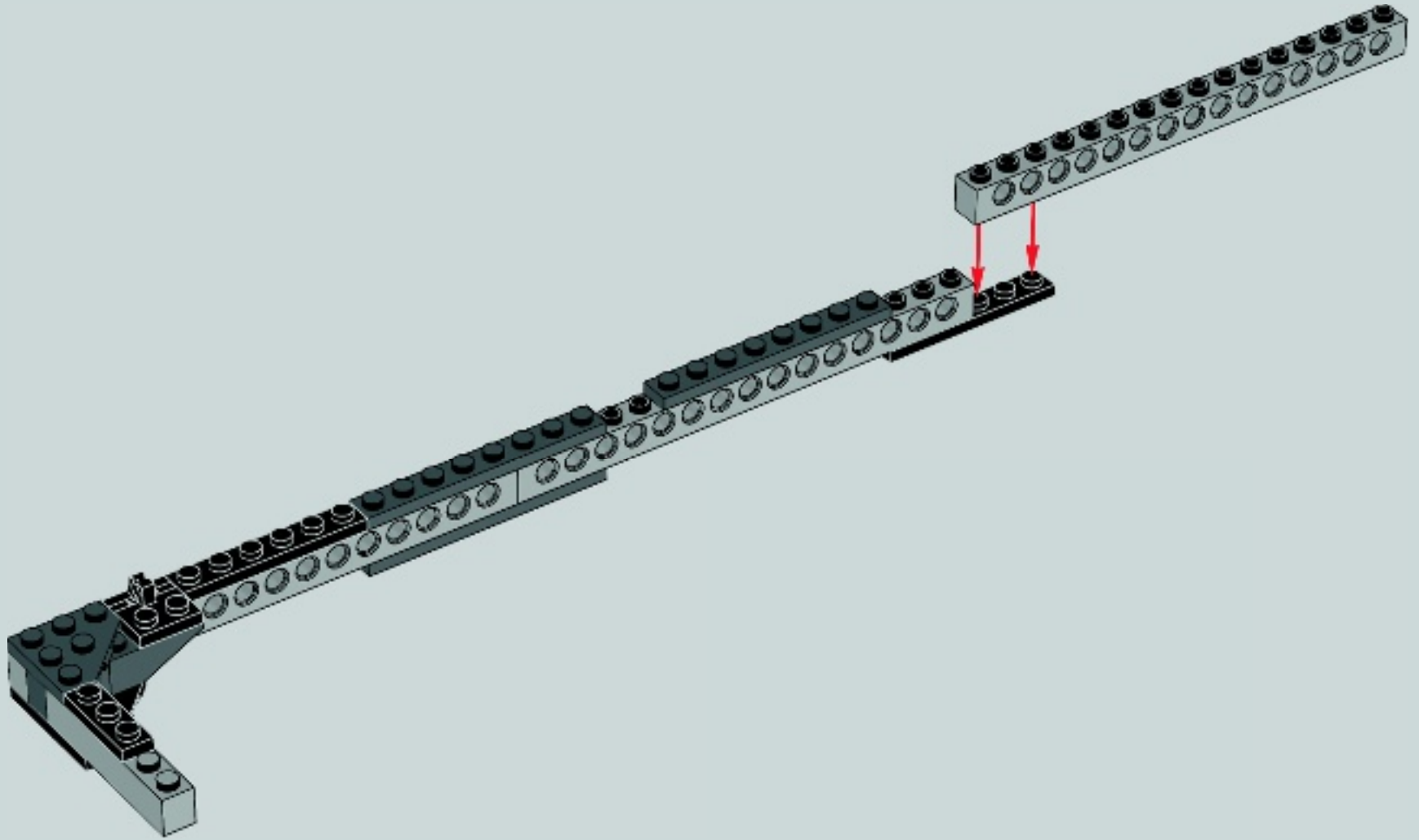

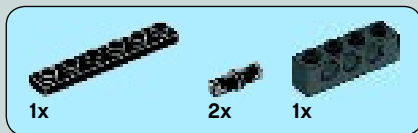

7



33

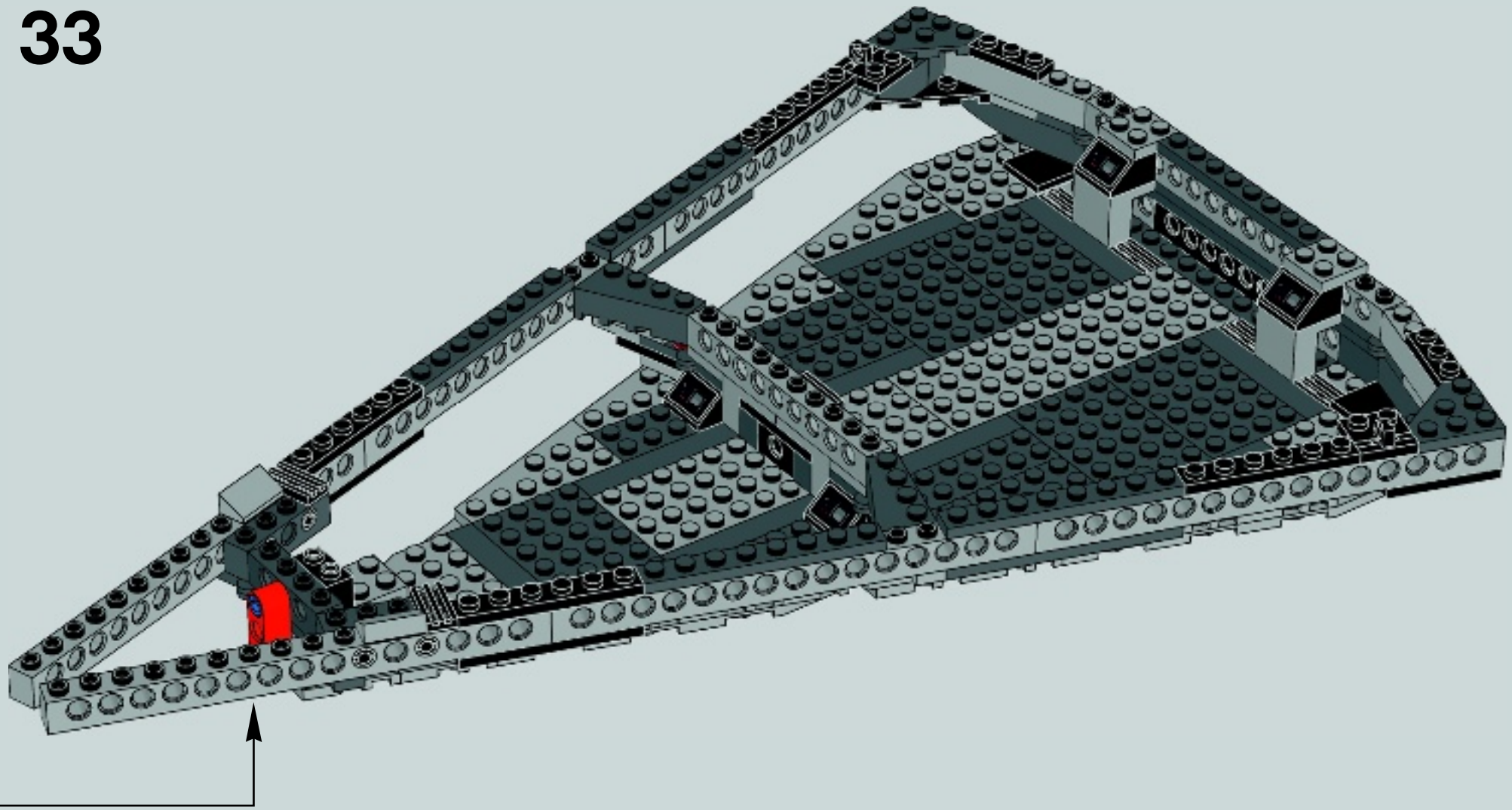

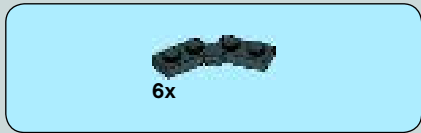

34

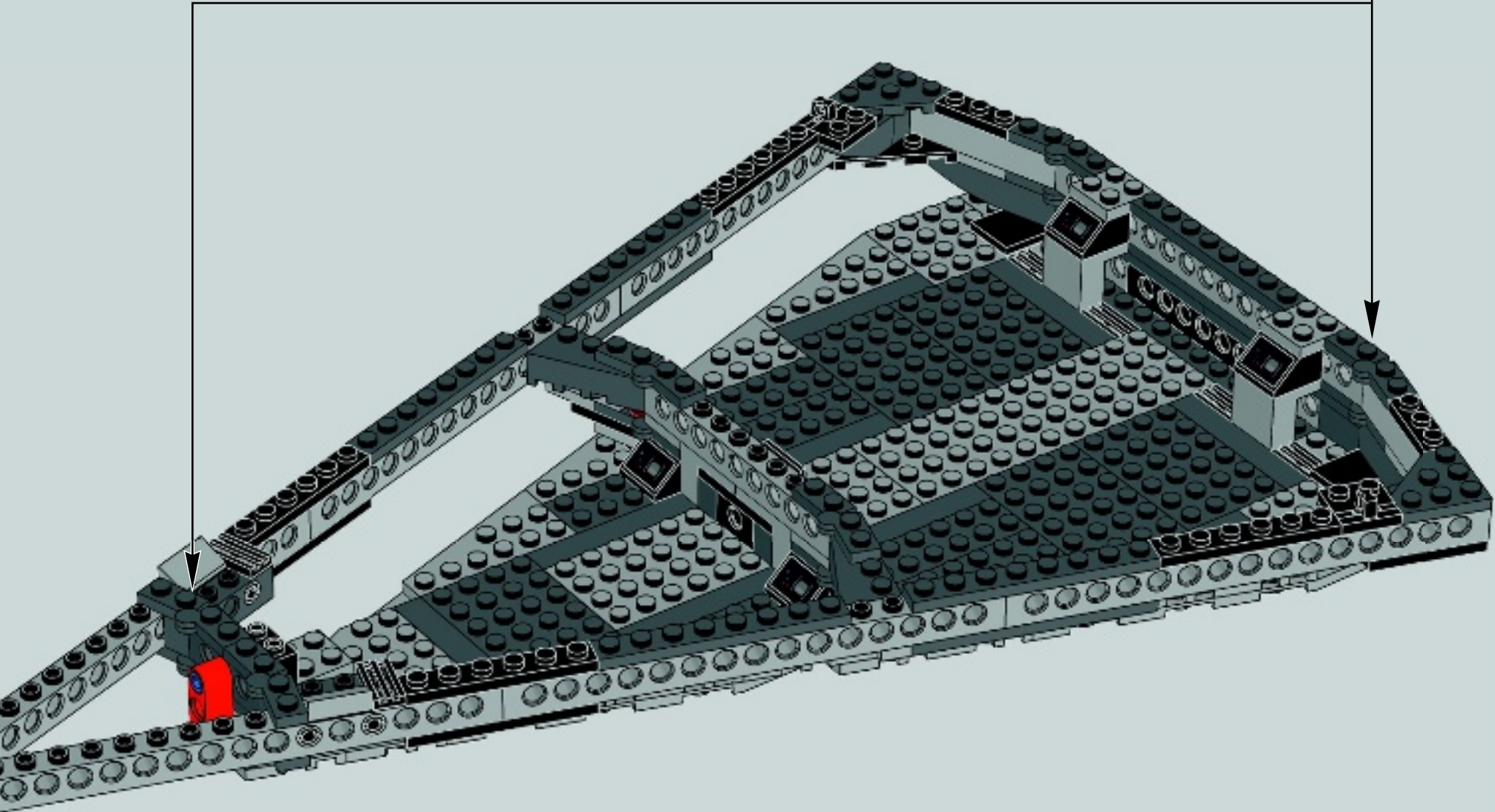

2x  2x 

35

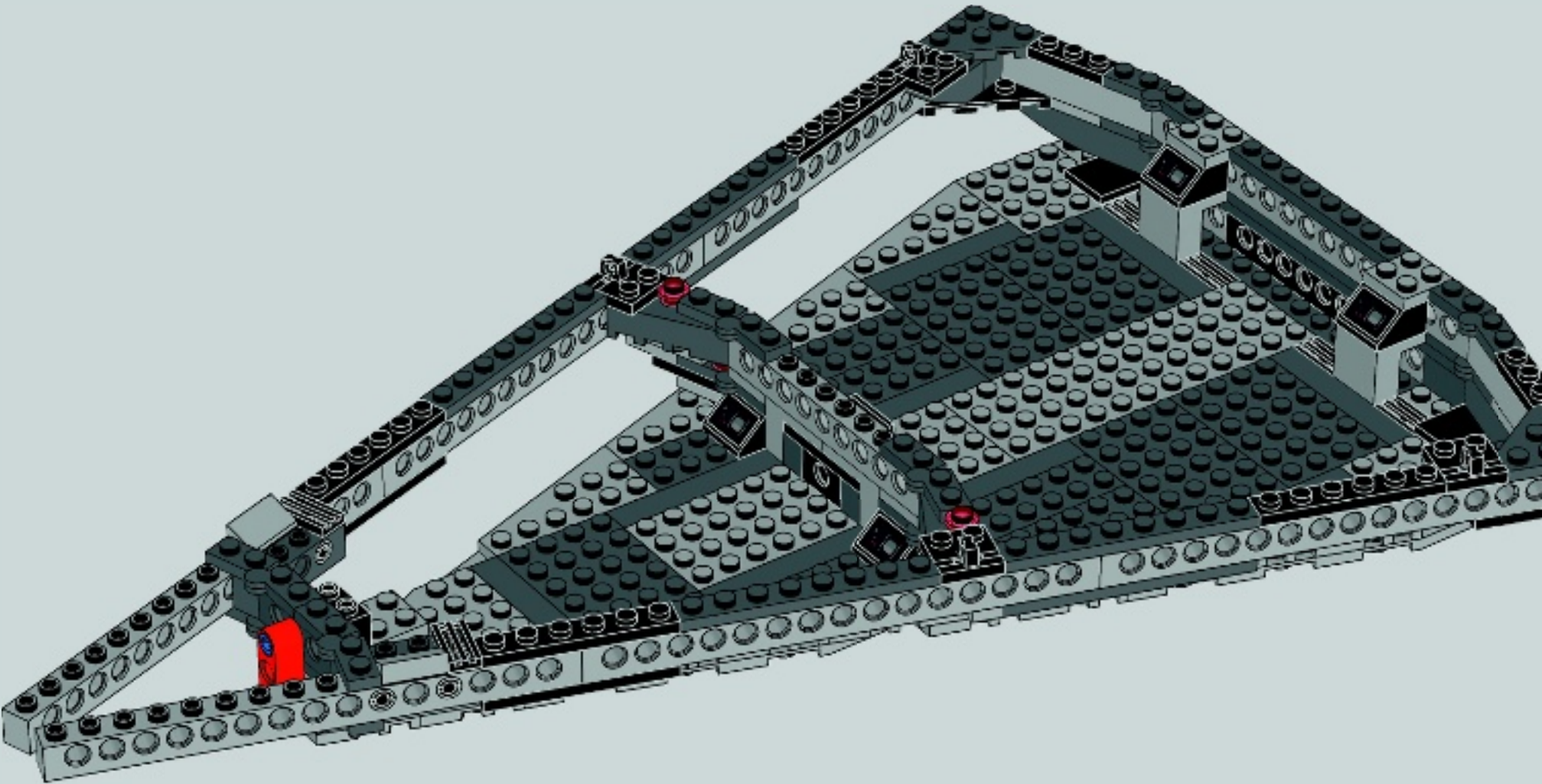

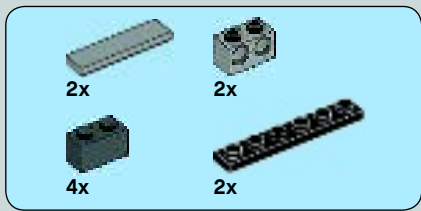

36

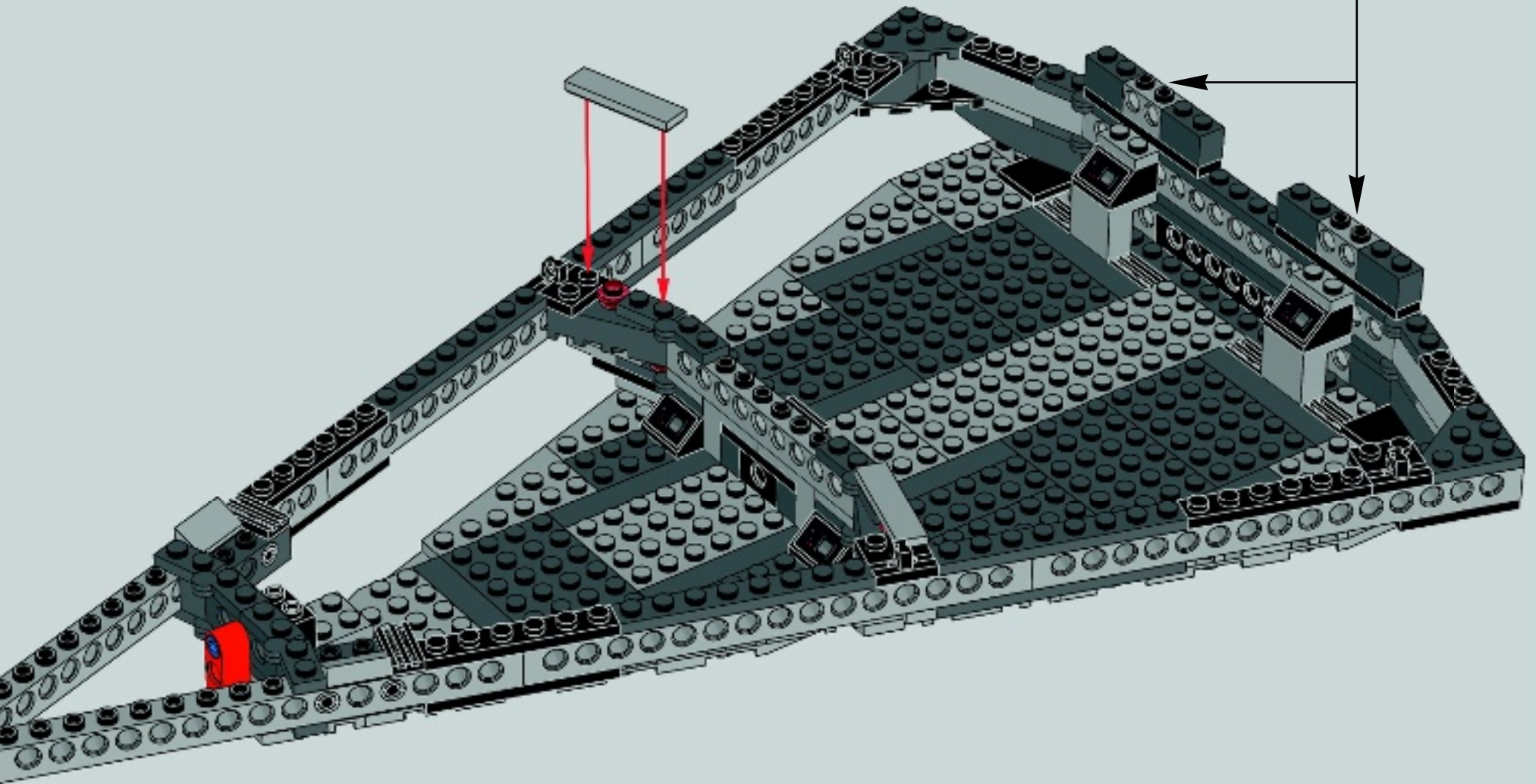
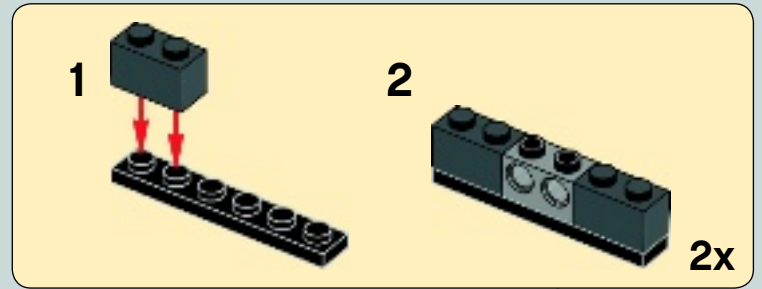

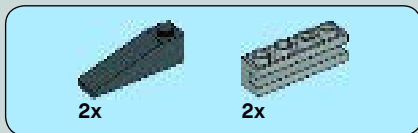

37

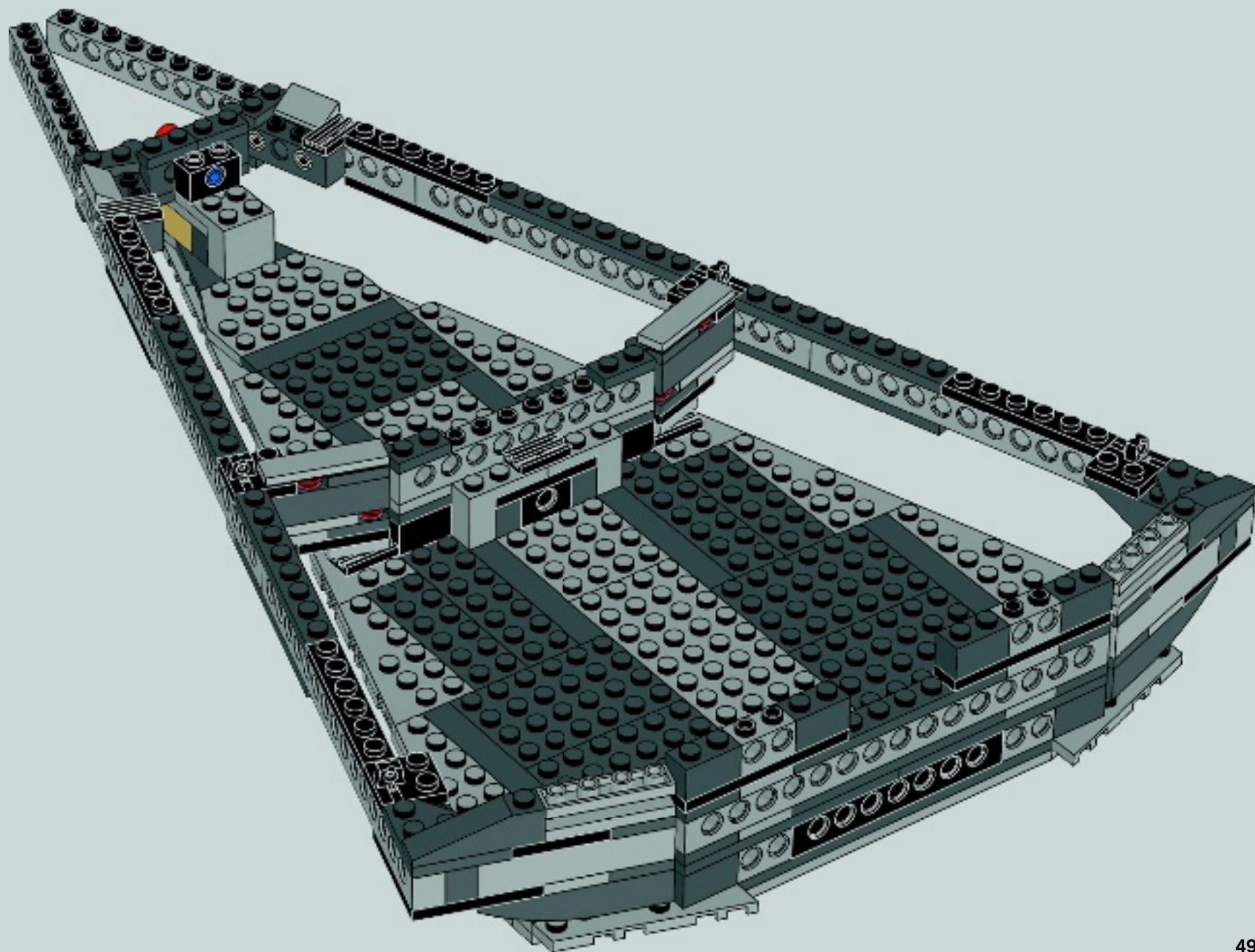
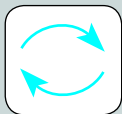



38

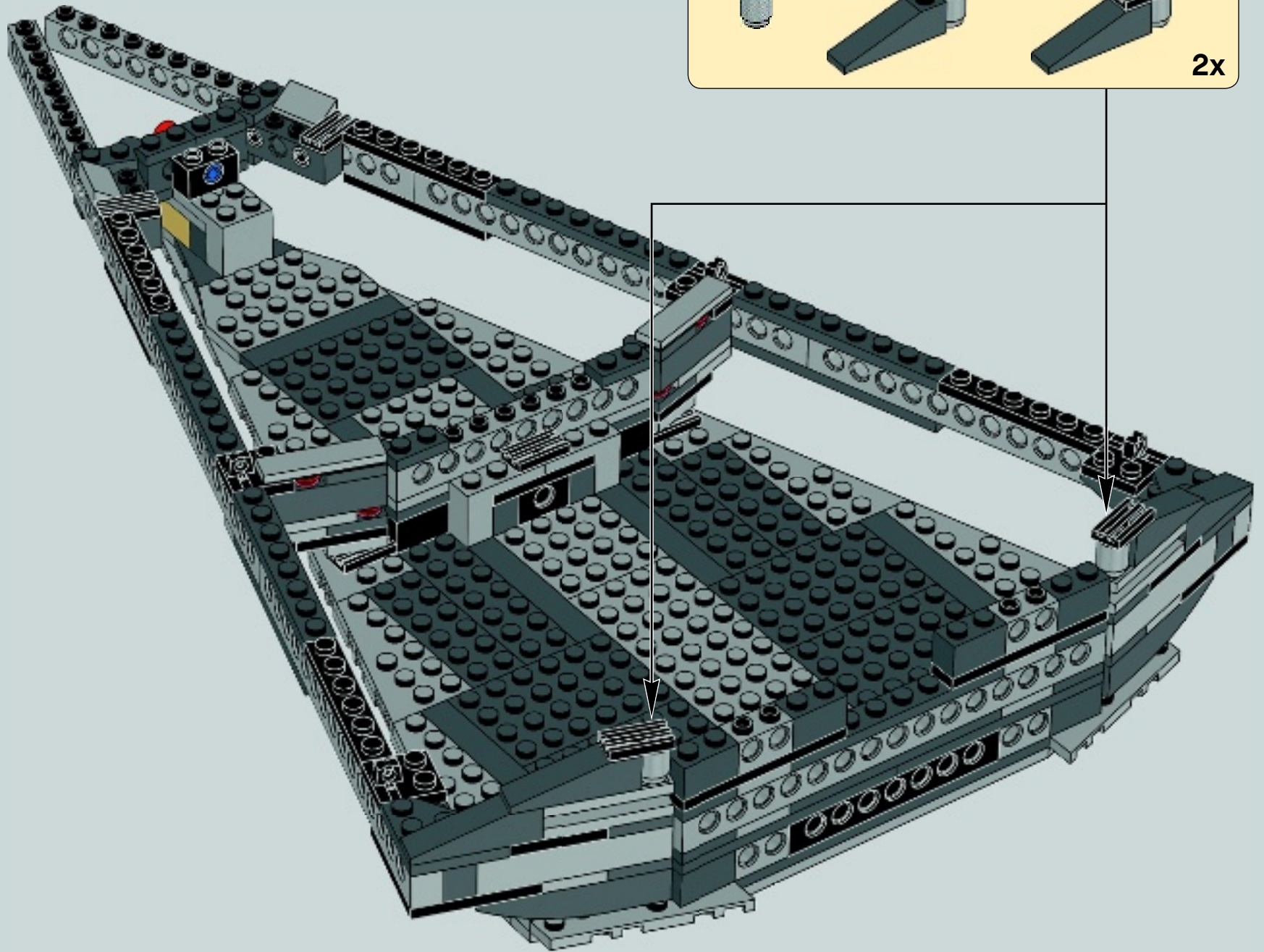
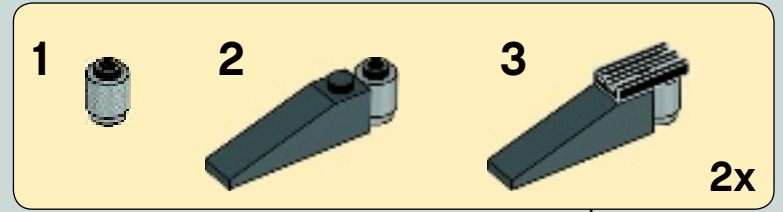

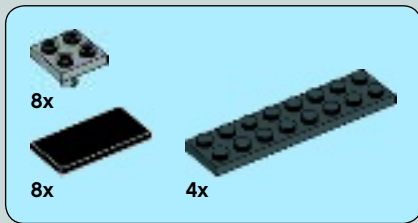

39

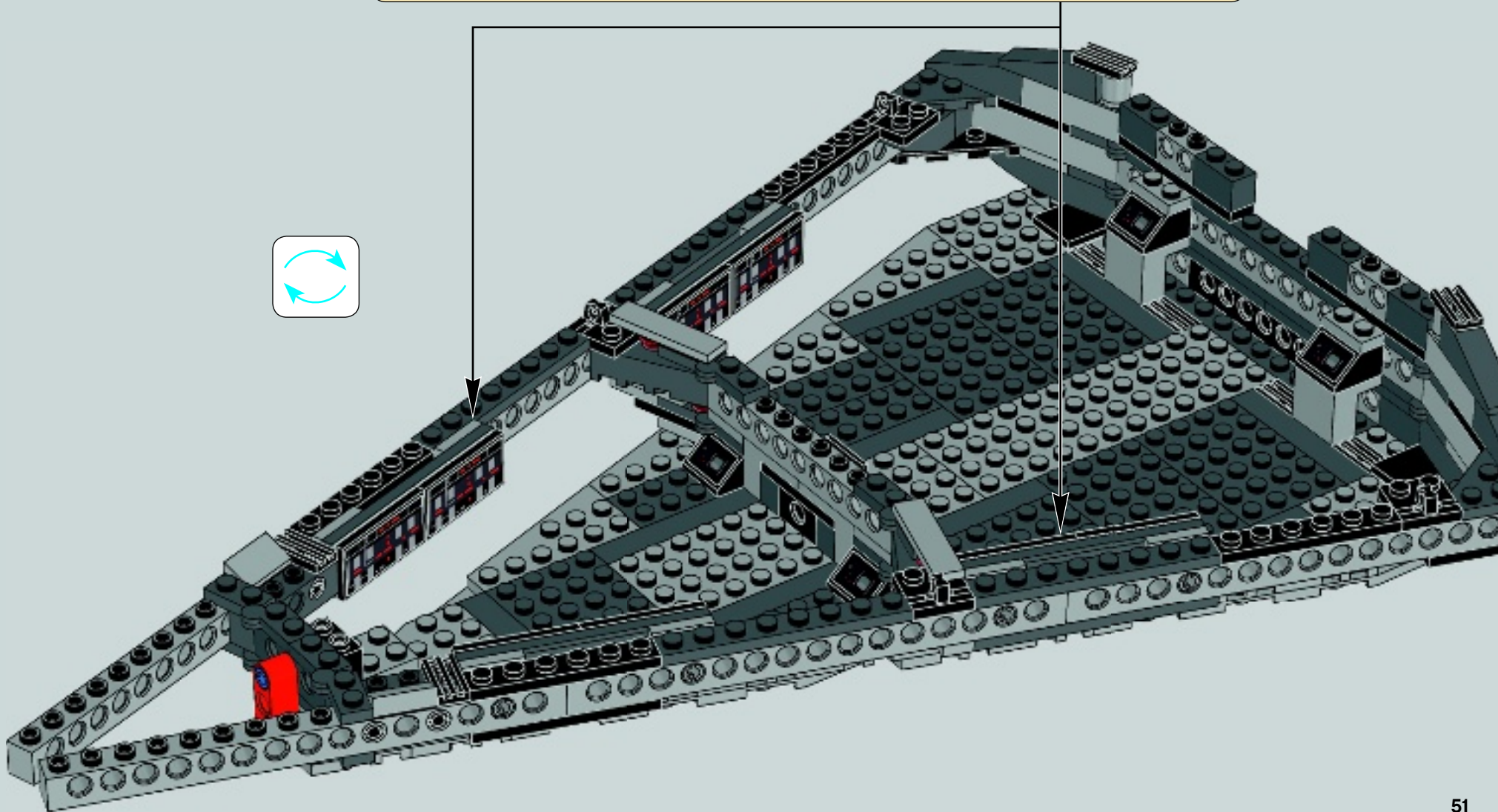
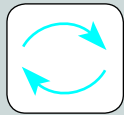
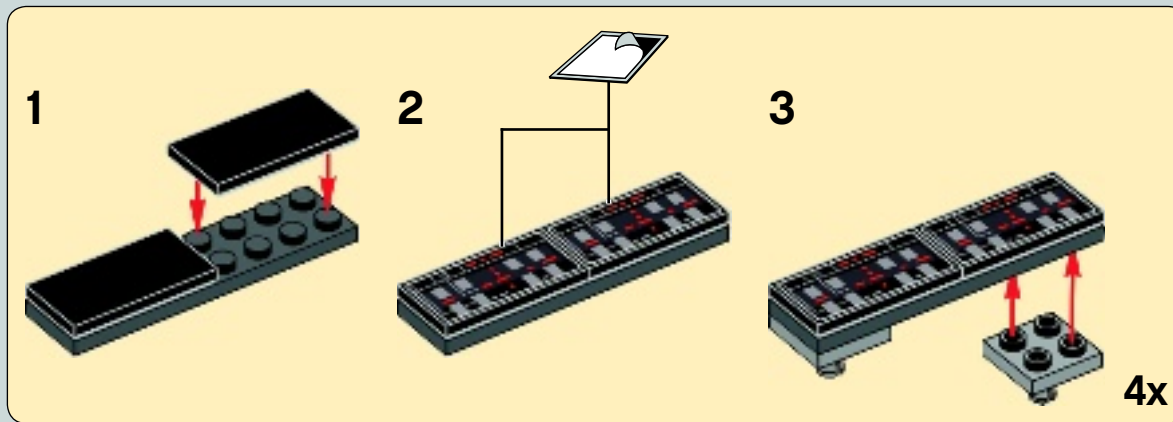

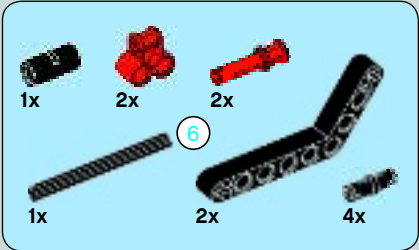
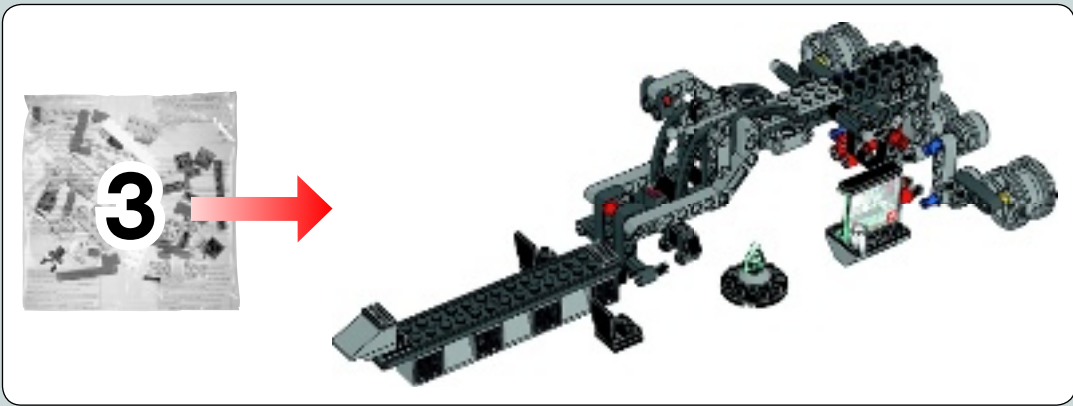

40

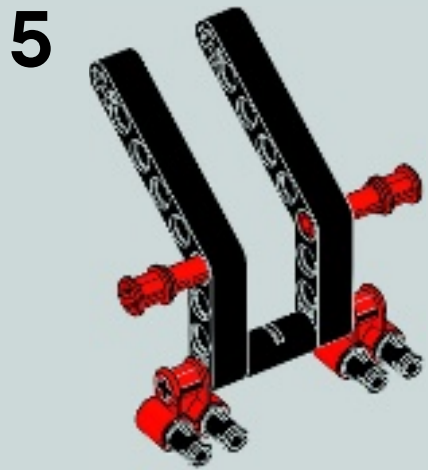
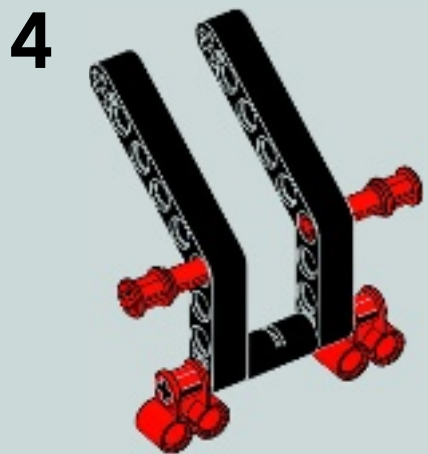
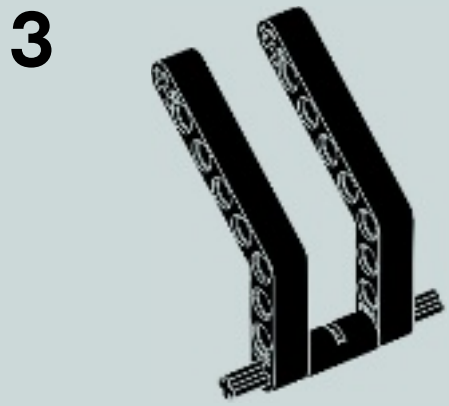
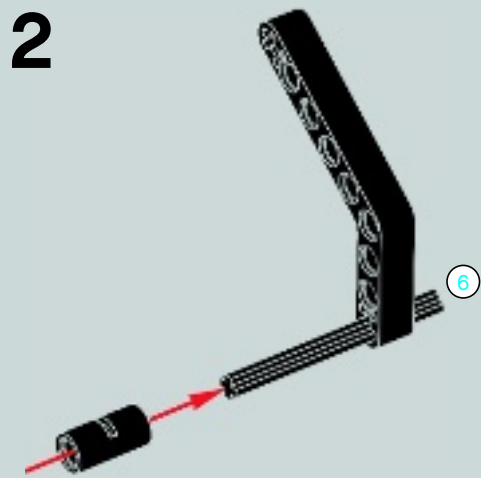

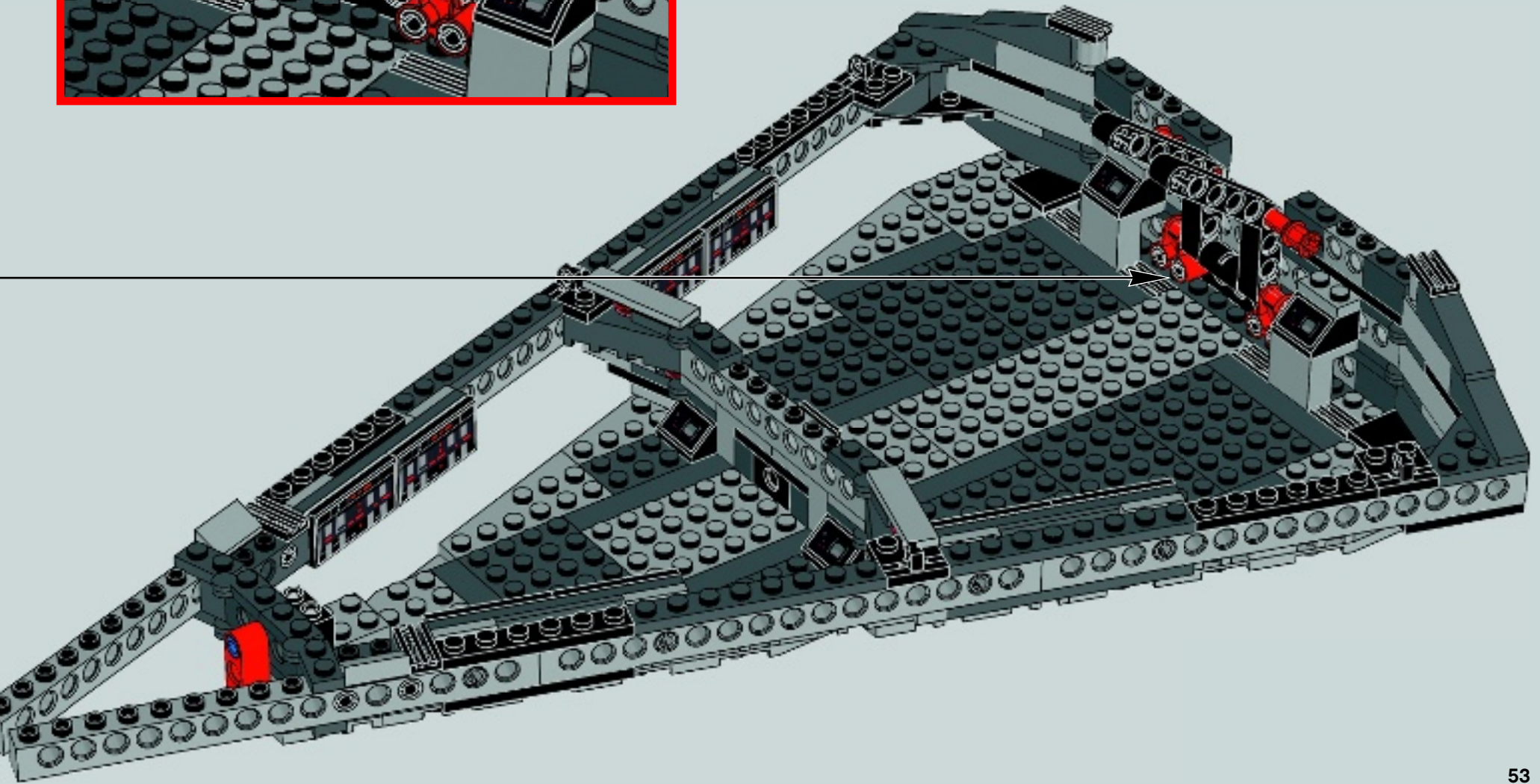
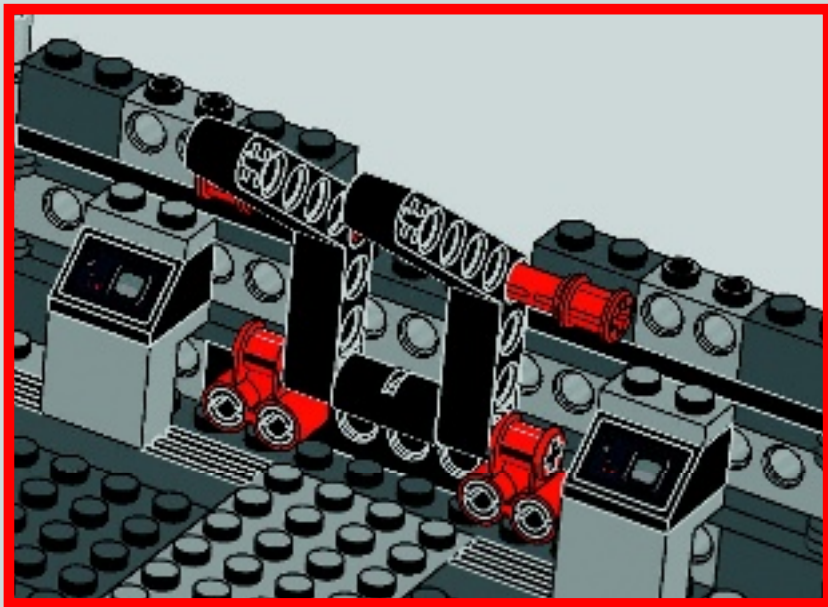

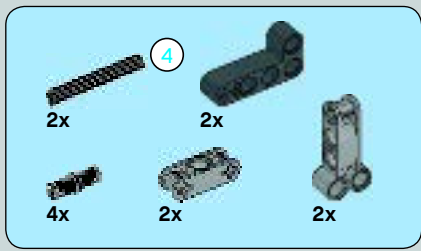

41

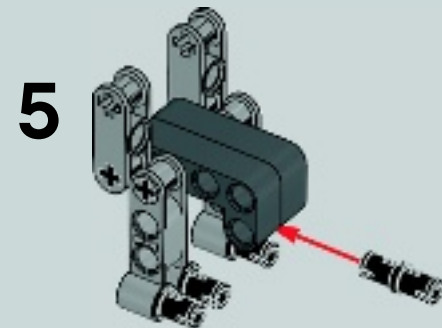
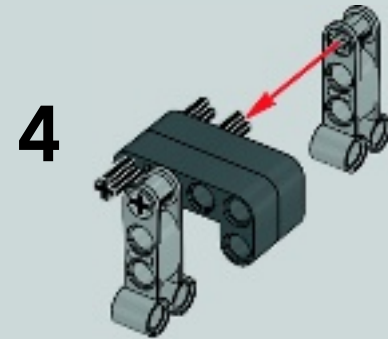
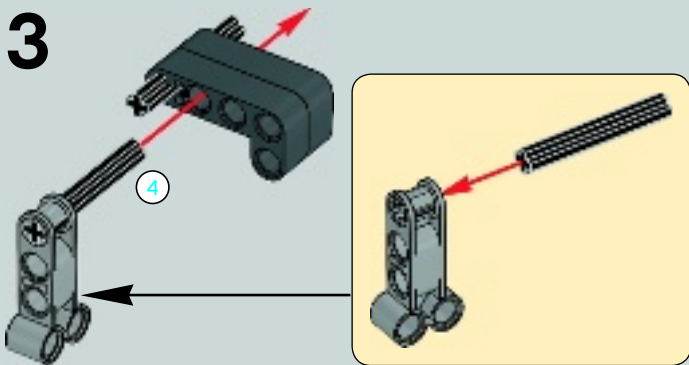

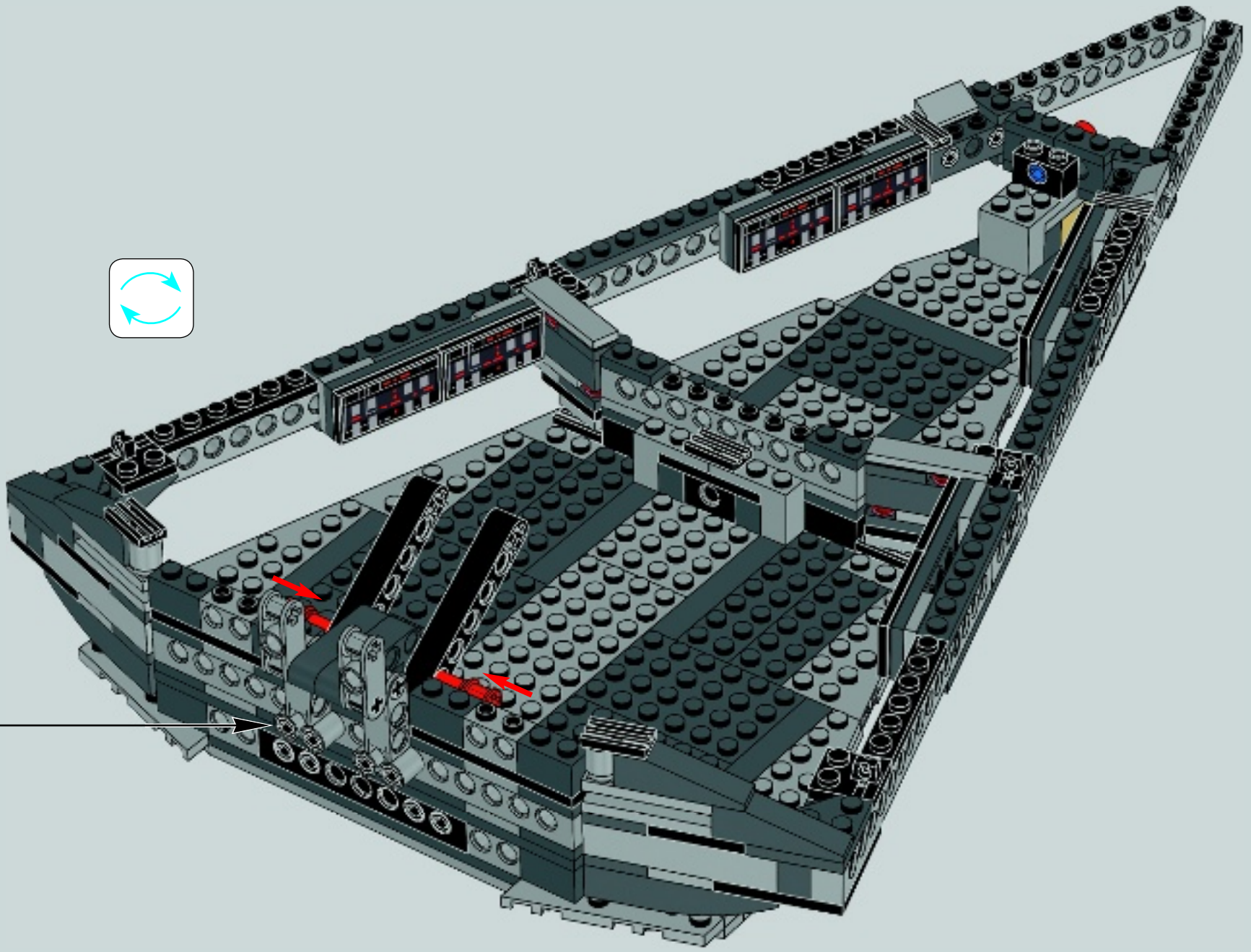

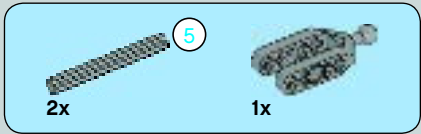
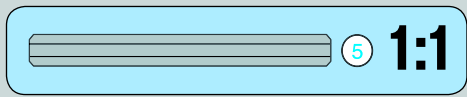
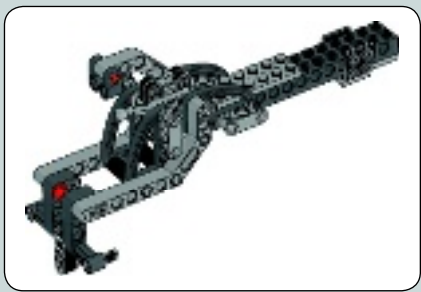

1

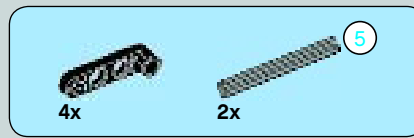
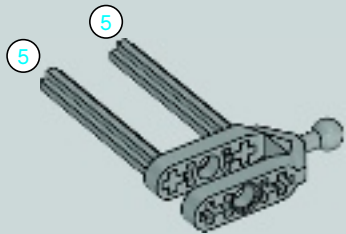

2

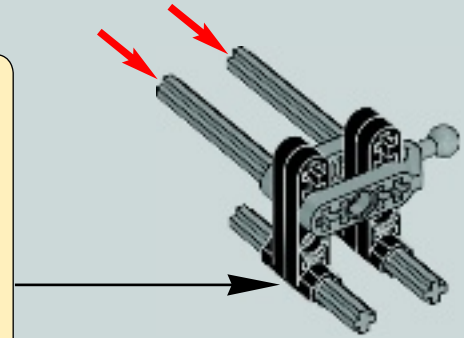
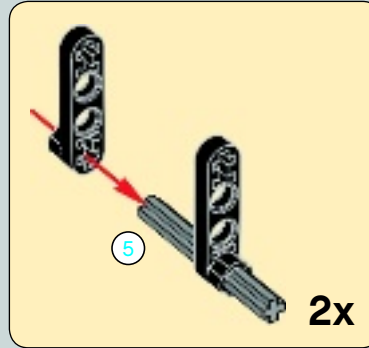

3

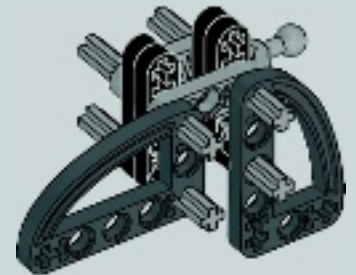

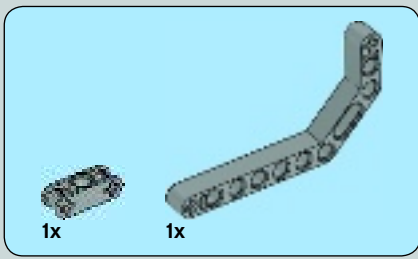

4

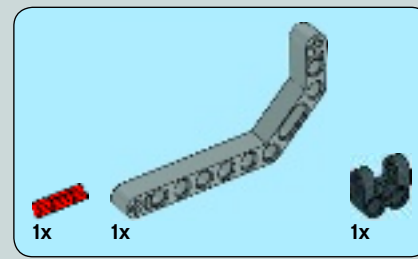
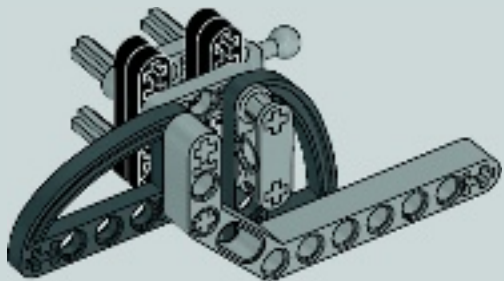

5

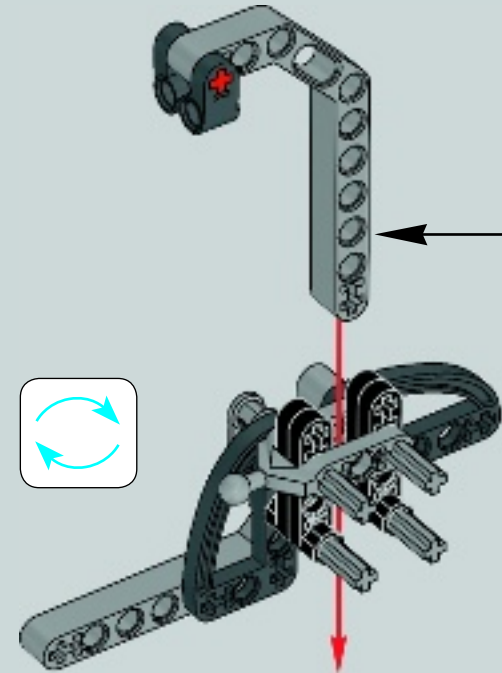
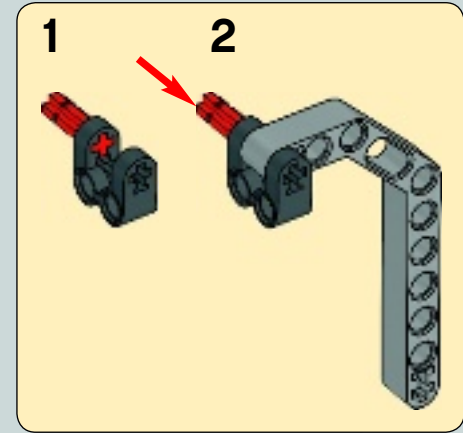



6

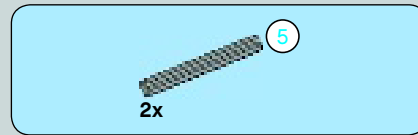
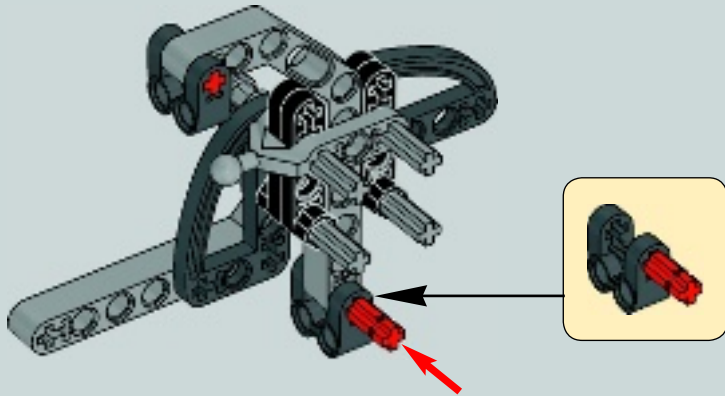

7

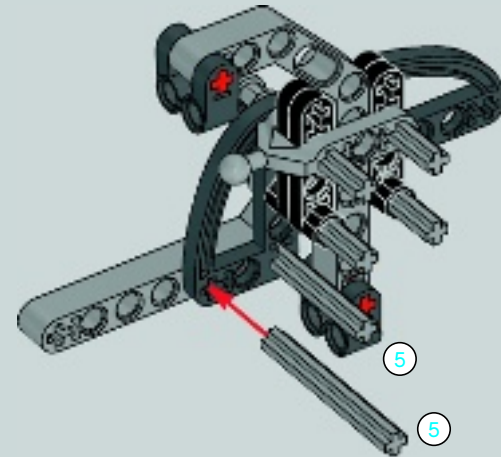

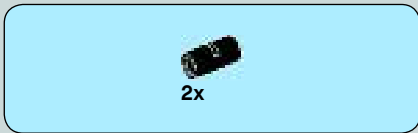

8

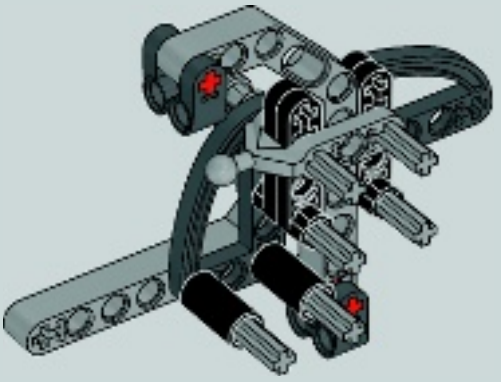

9

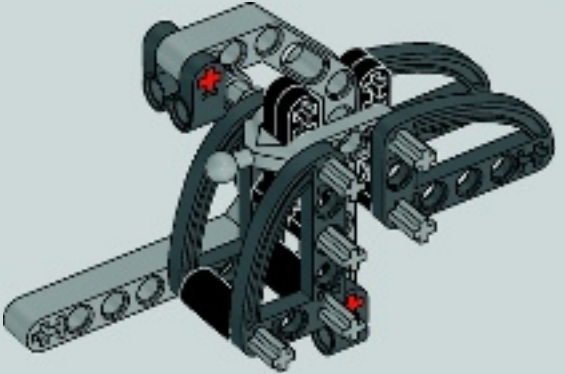

10

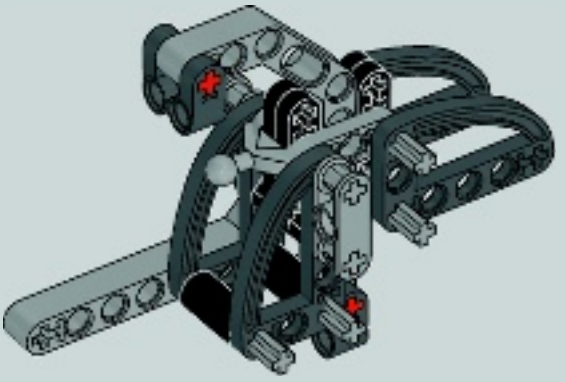

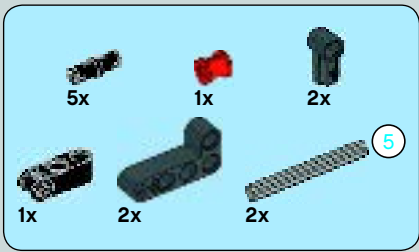

11

1



2

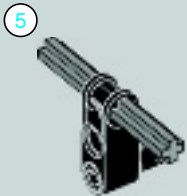

3



4

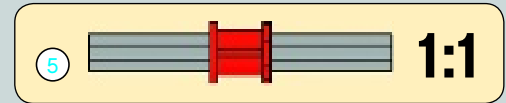

5

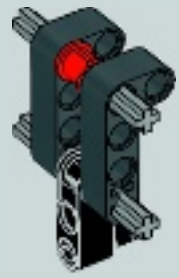

7

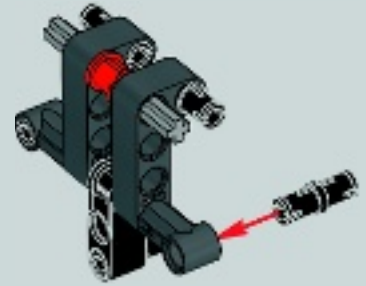

6

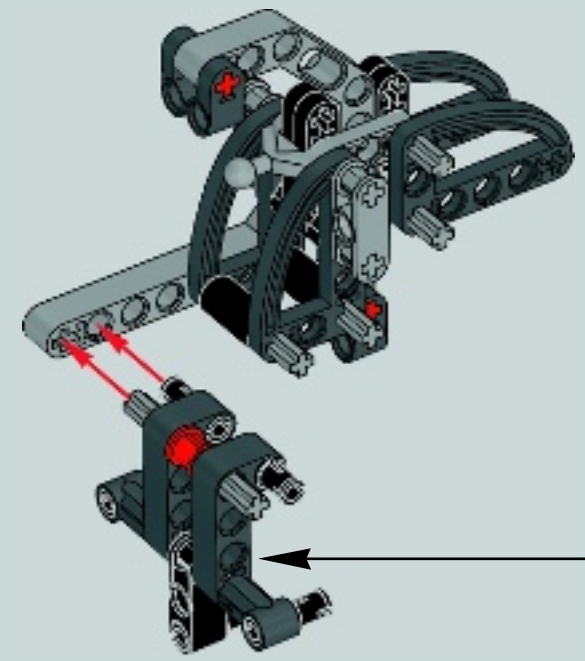
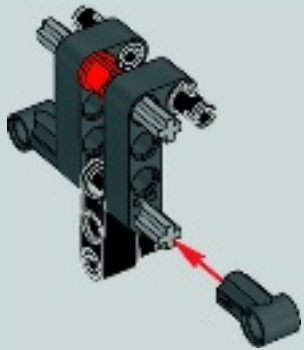

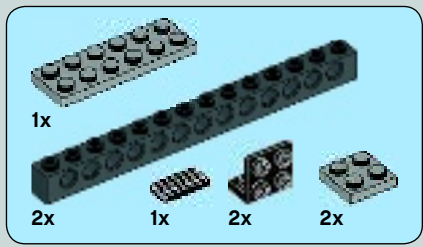

12

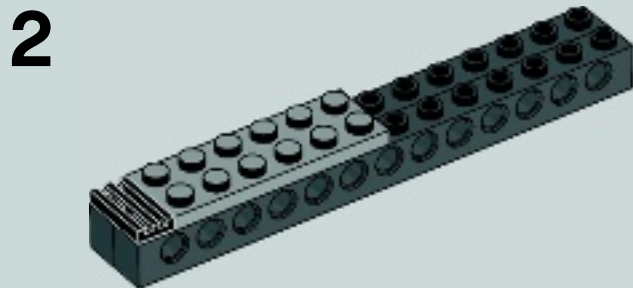
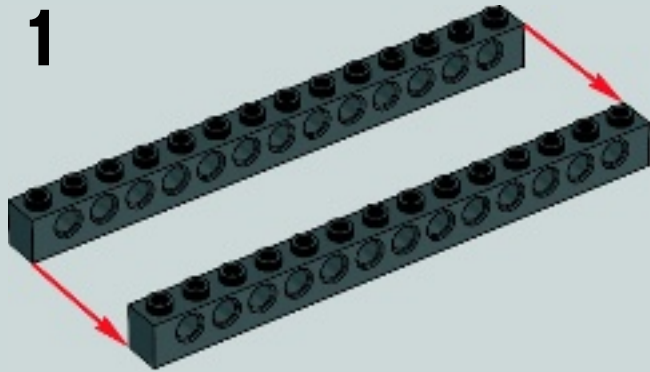

3

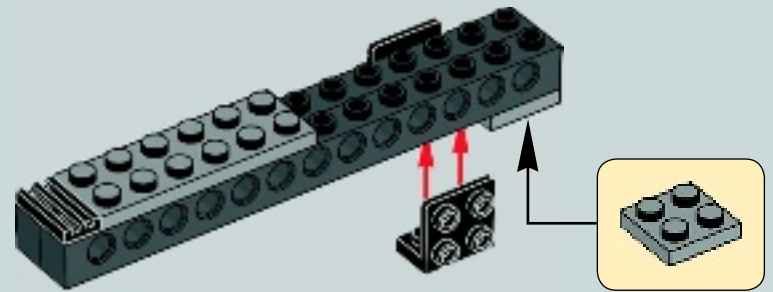

4

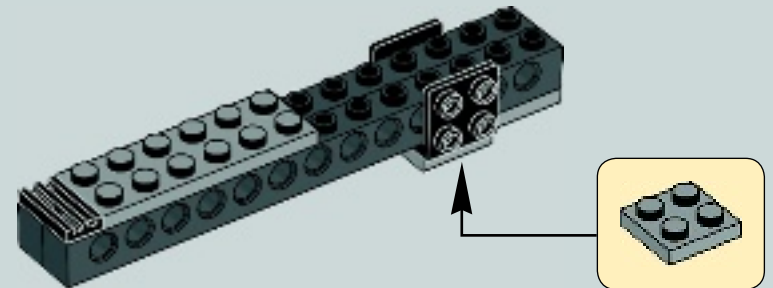

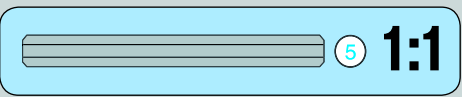
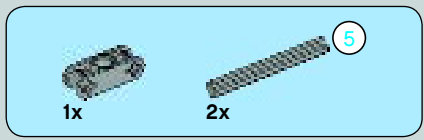

13

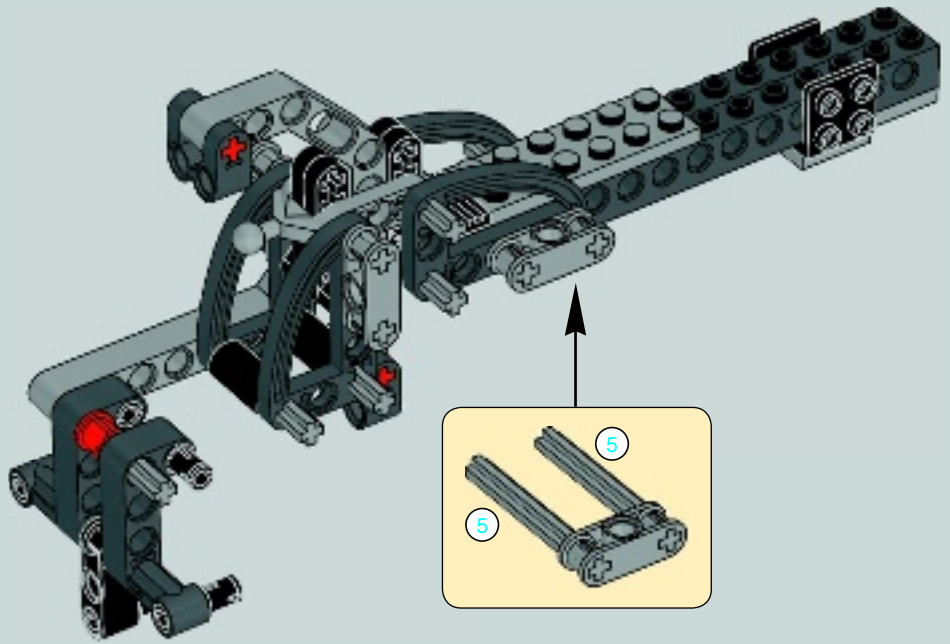
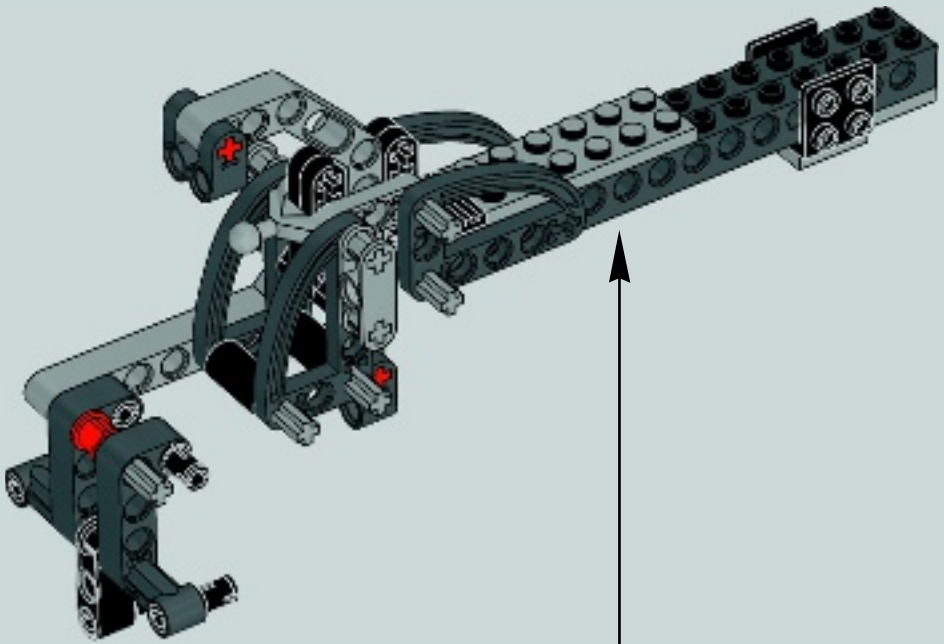

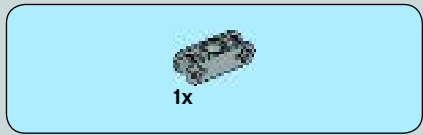

14

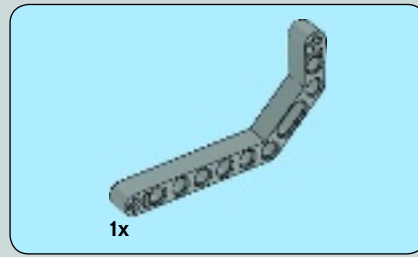
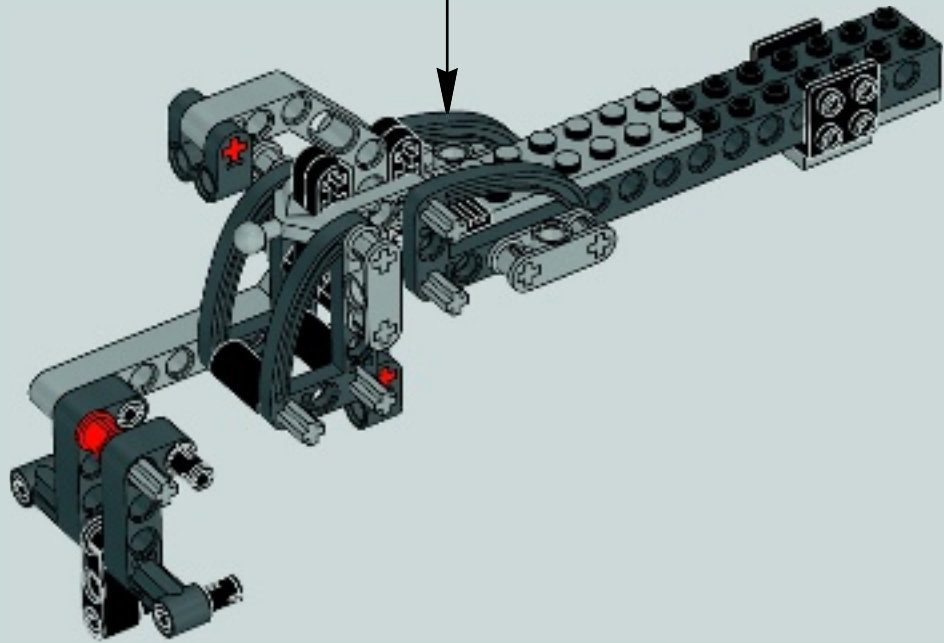

15

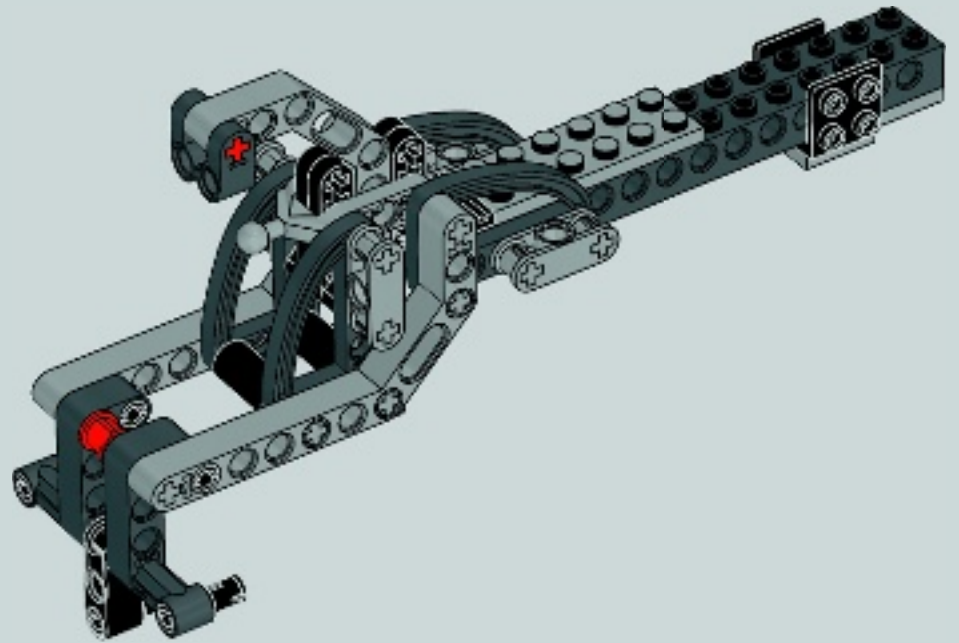

42

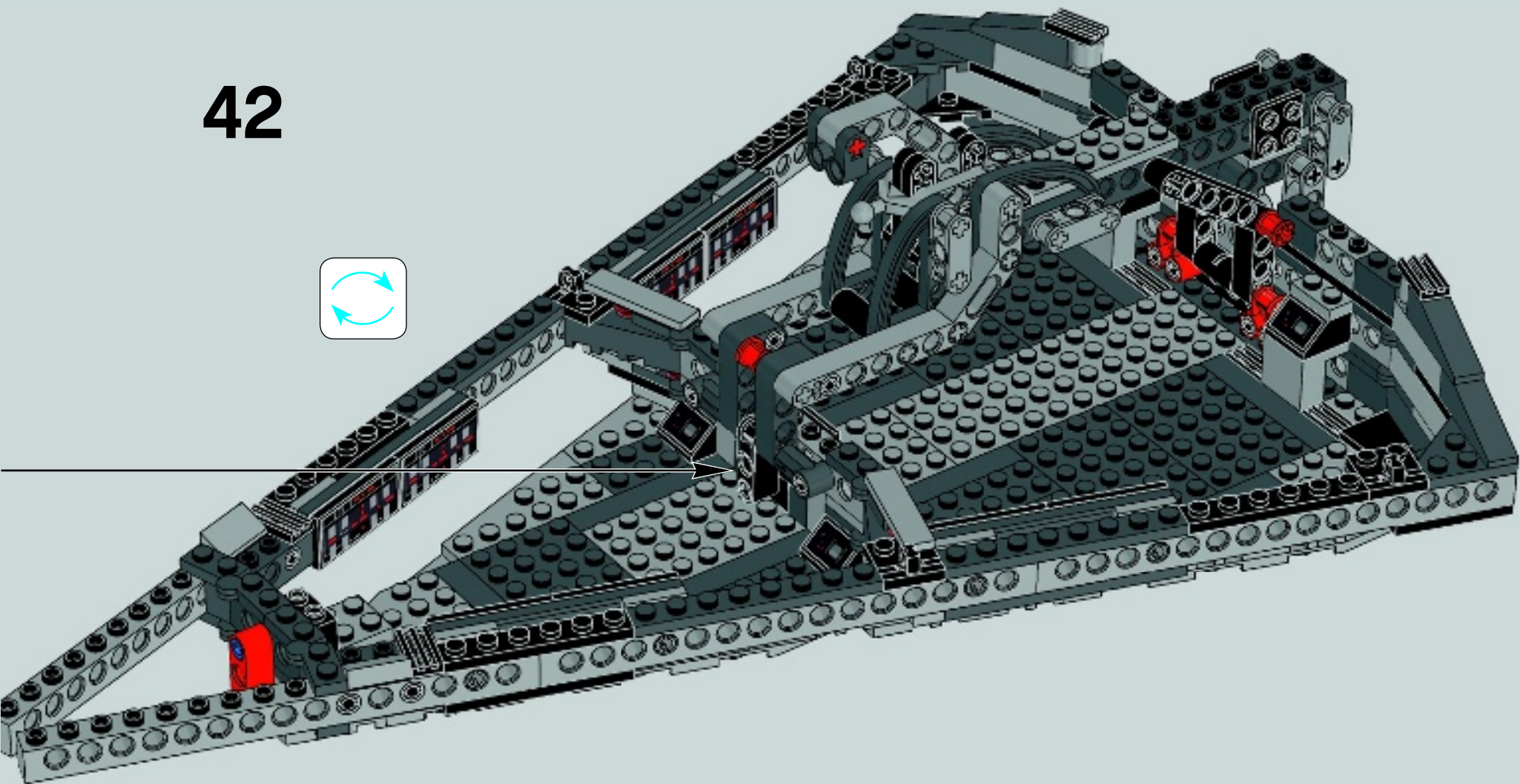
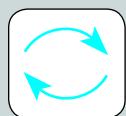

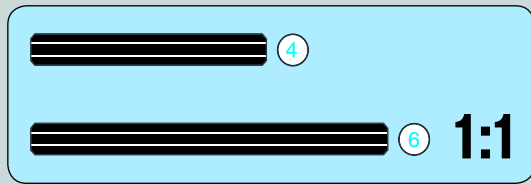
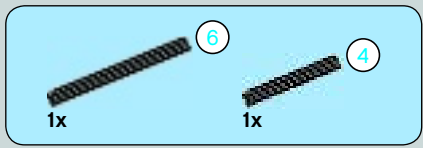

43

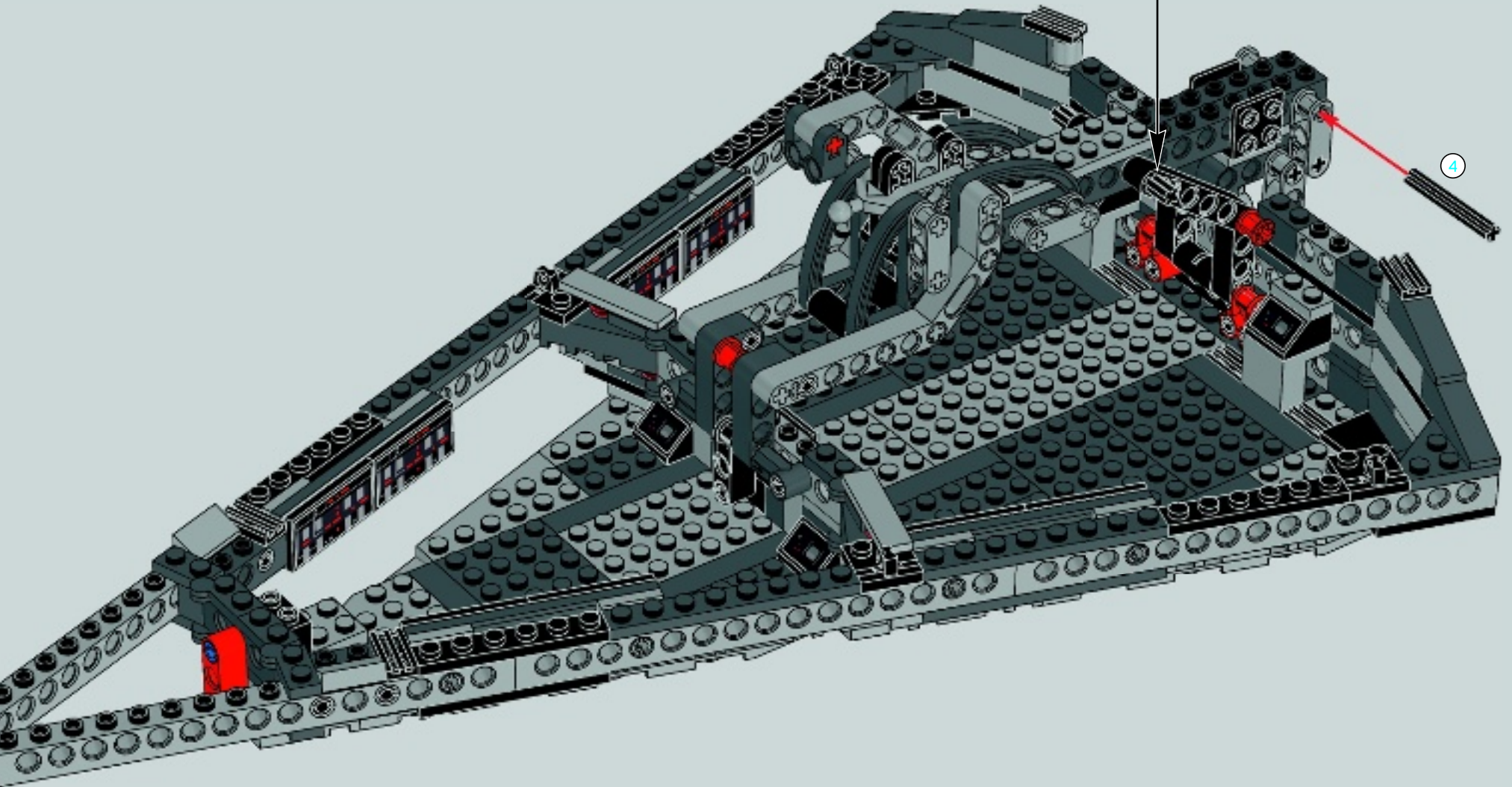
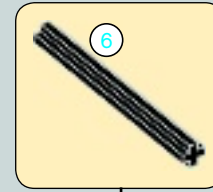

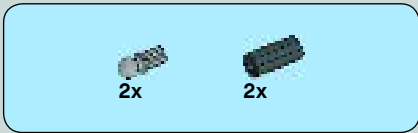

44

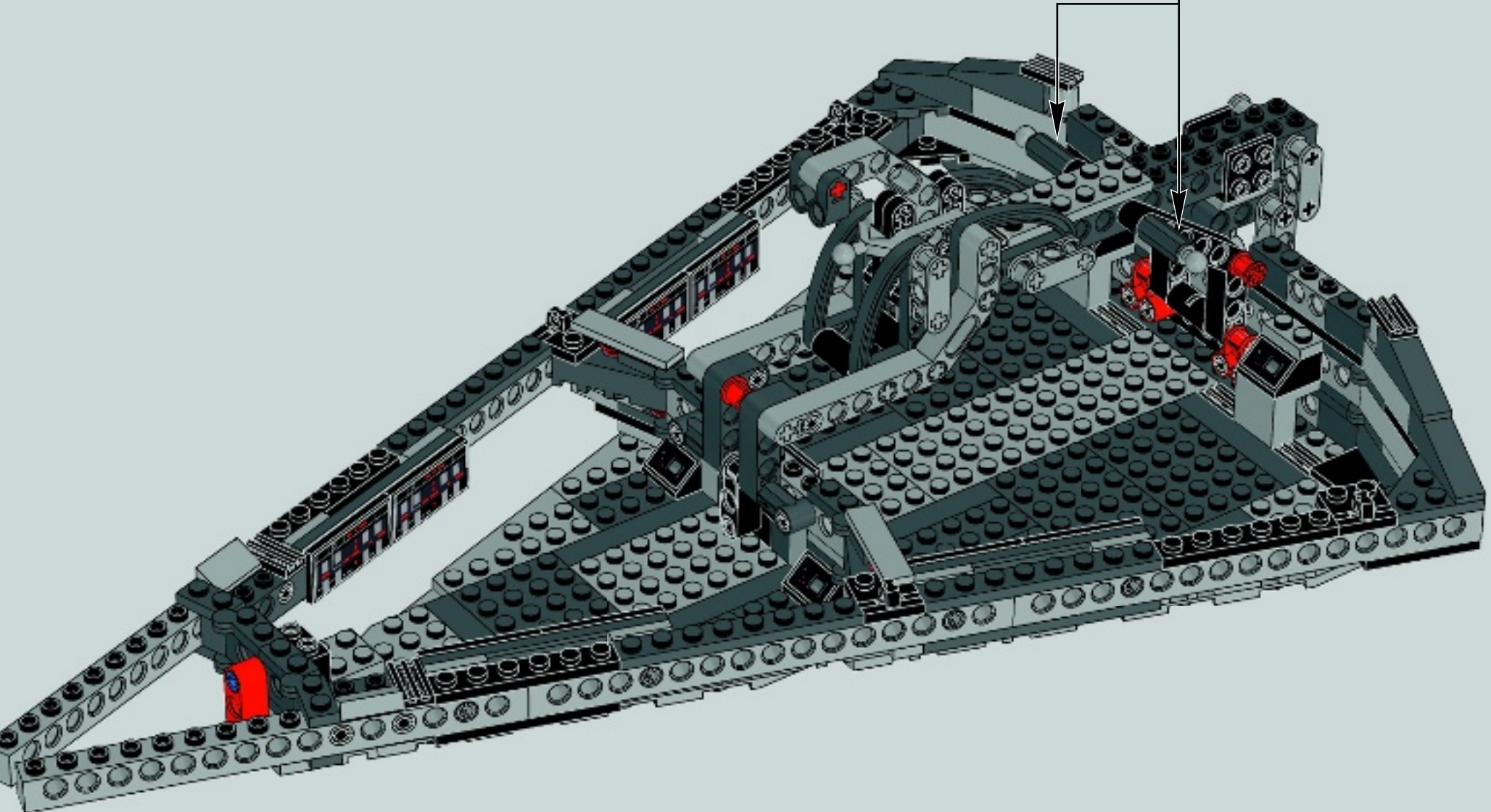
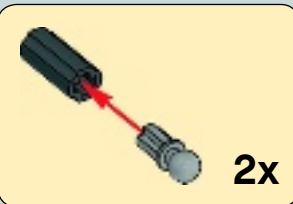

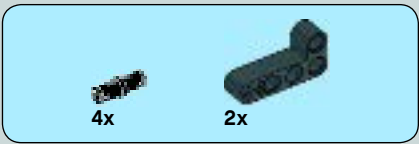

45

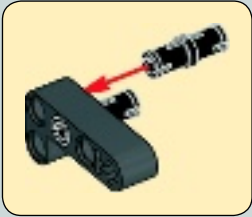
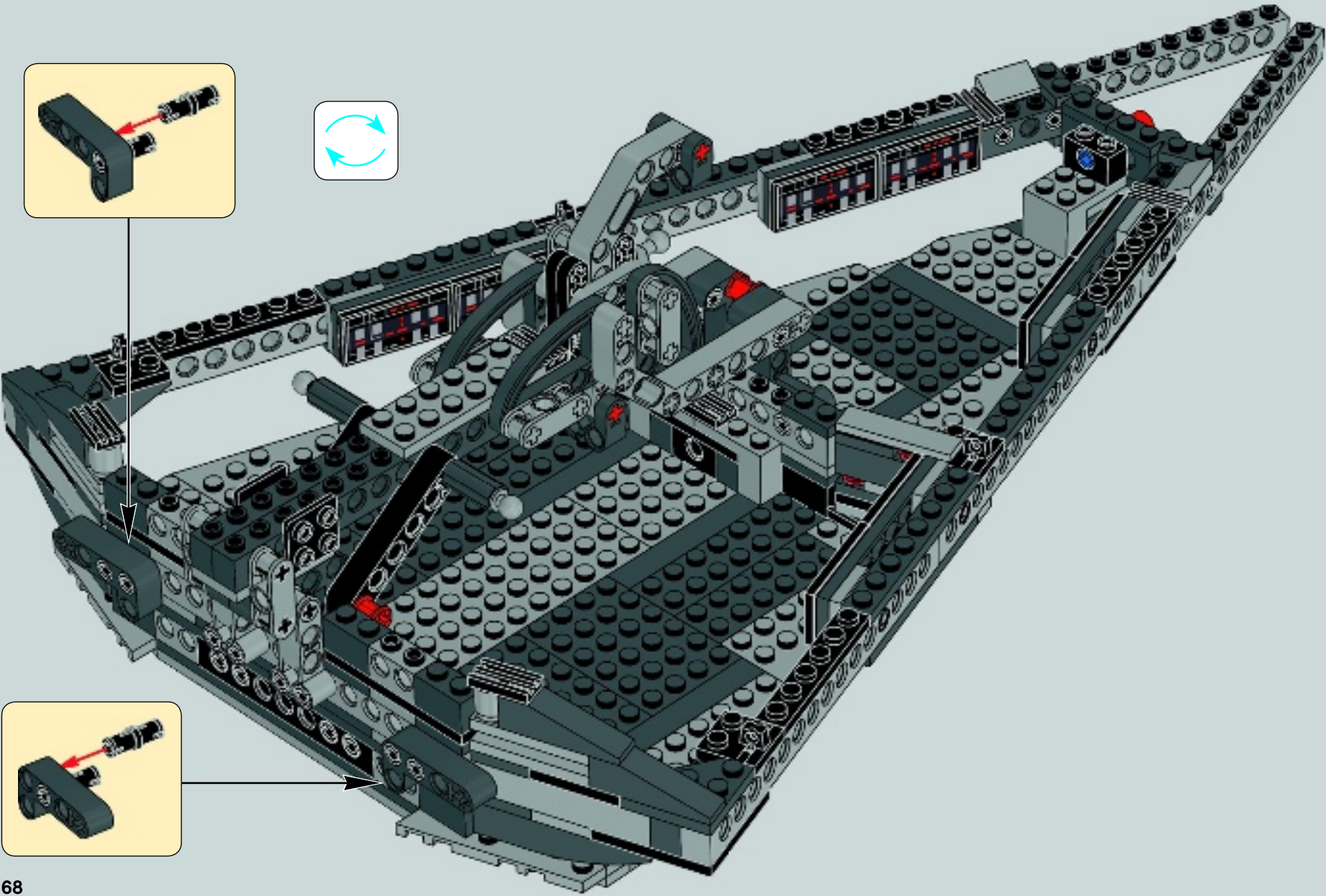
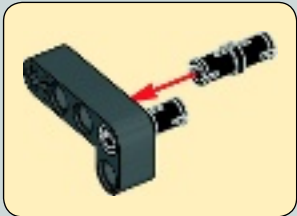

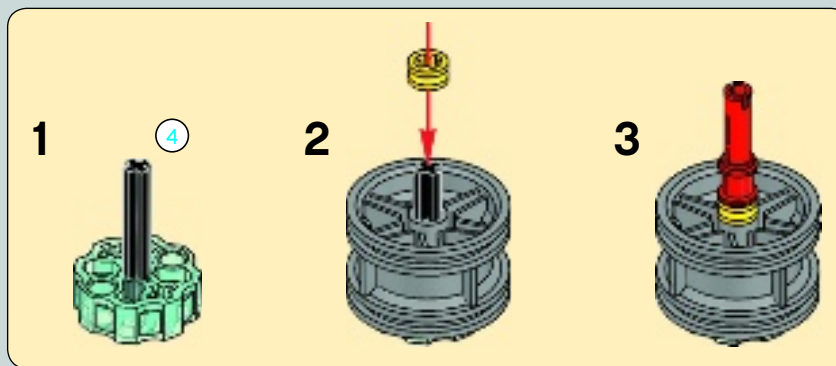
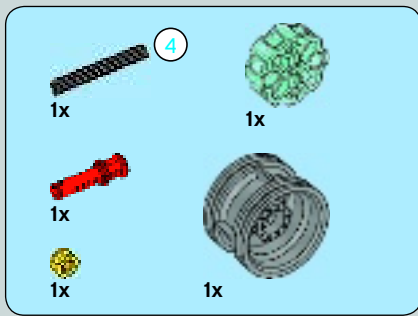

46

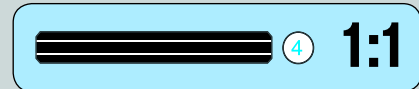
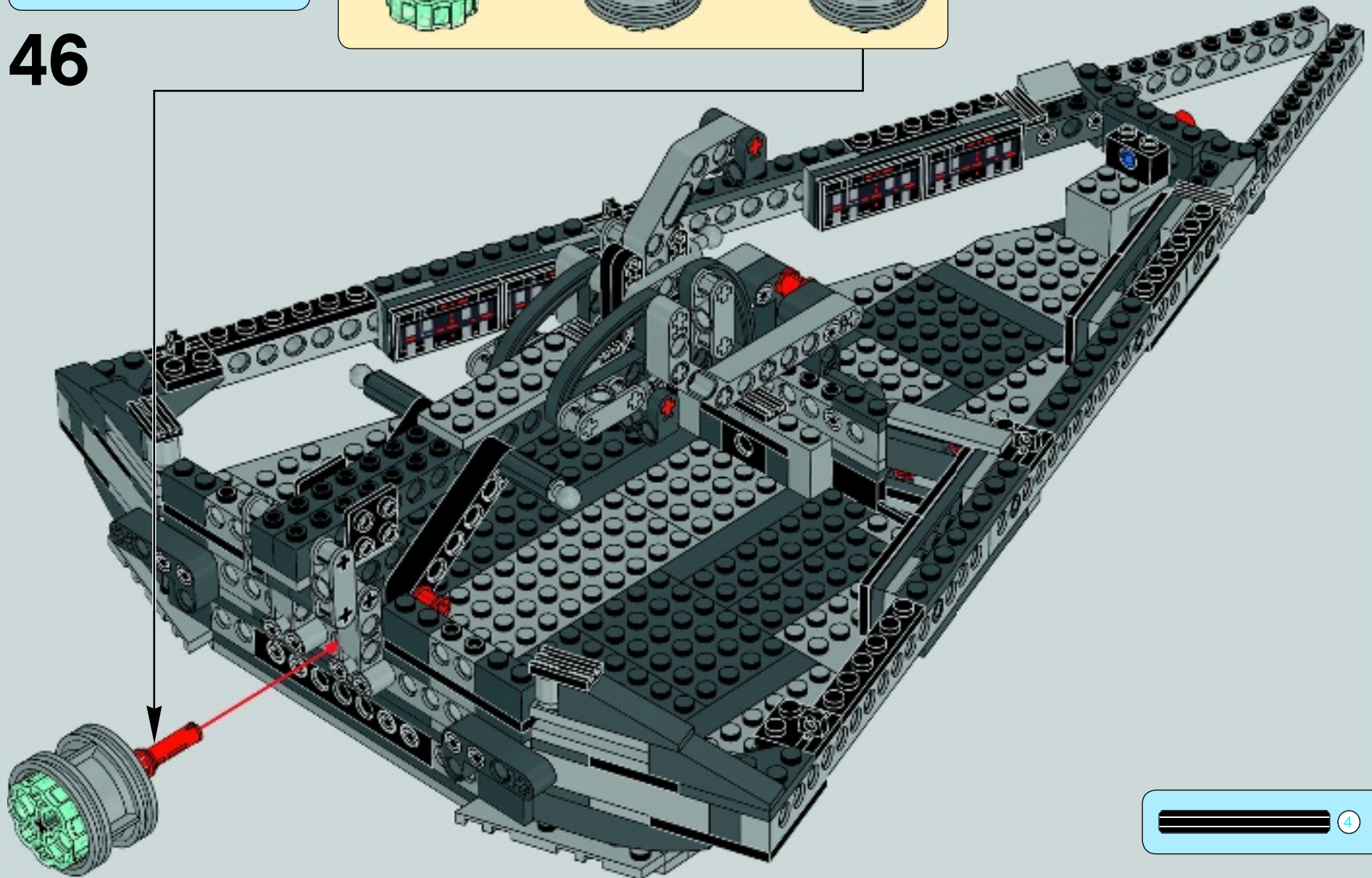

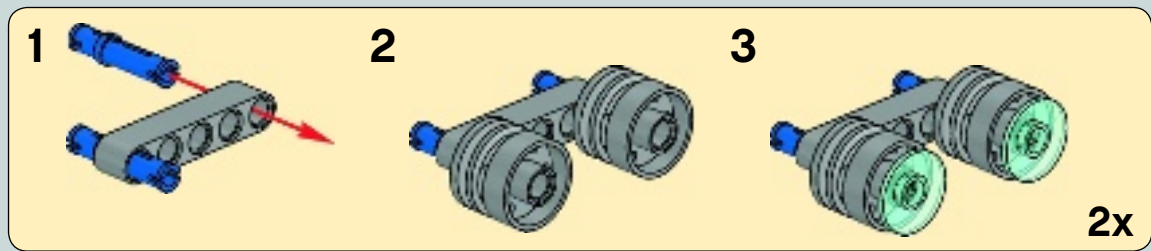
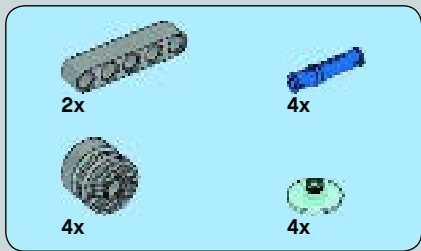

47

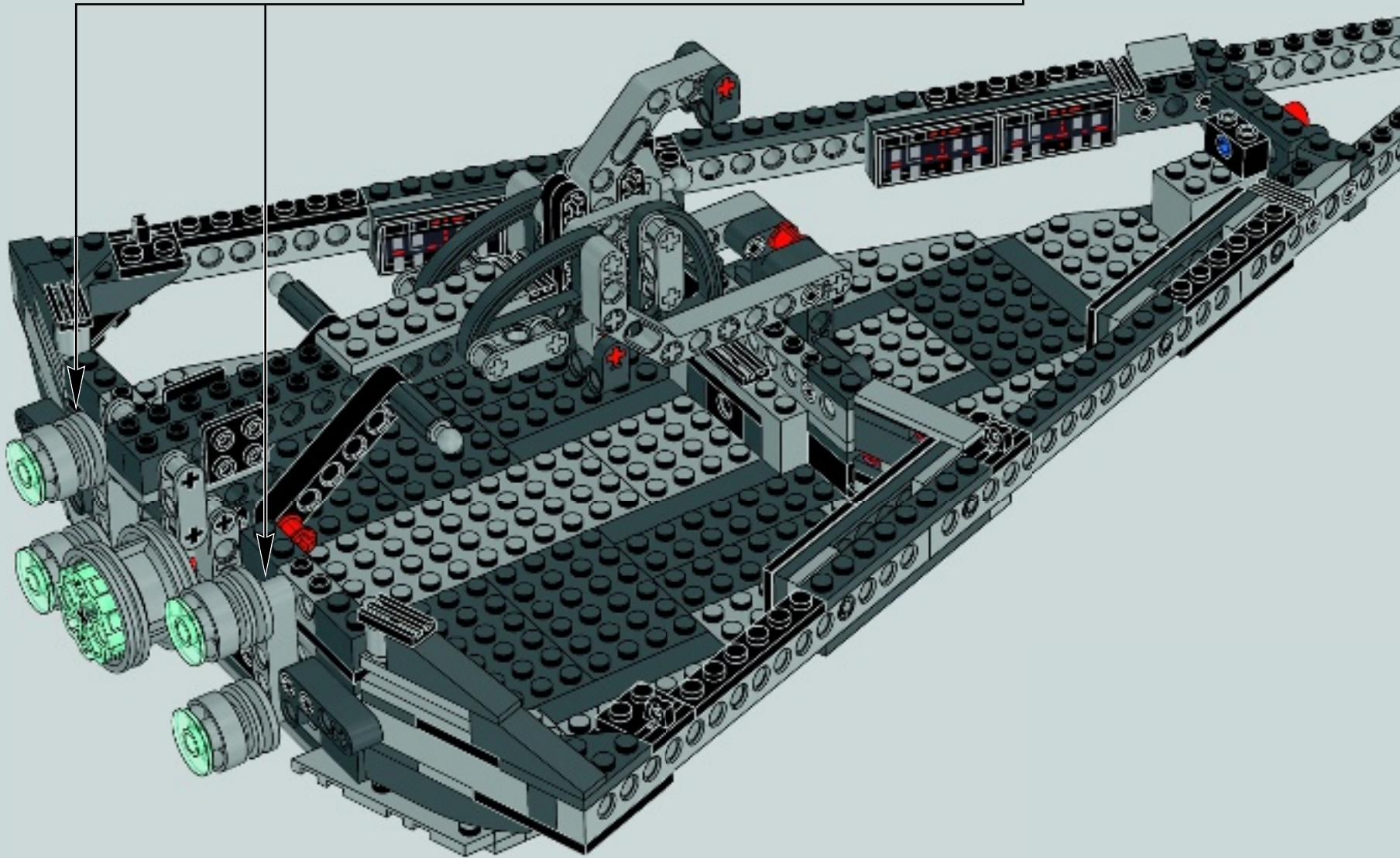

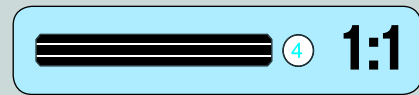
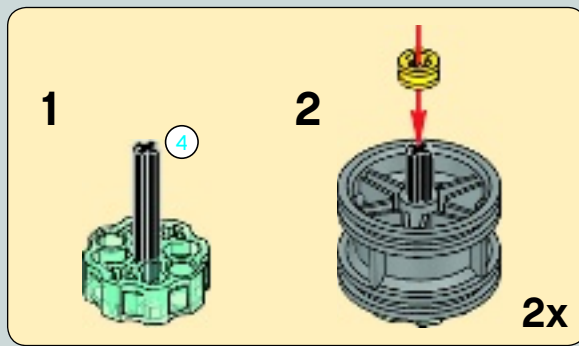
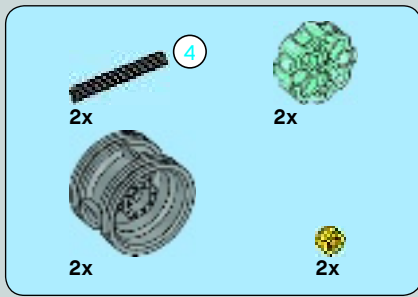

48

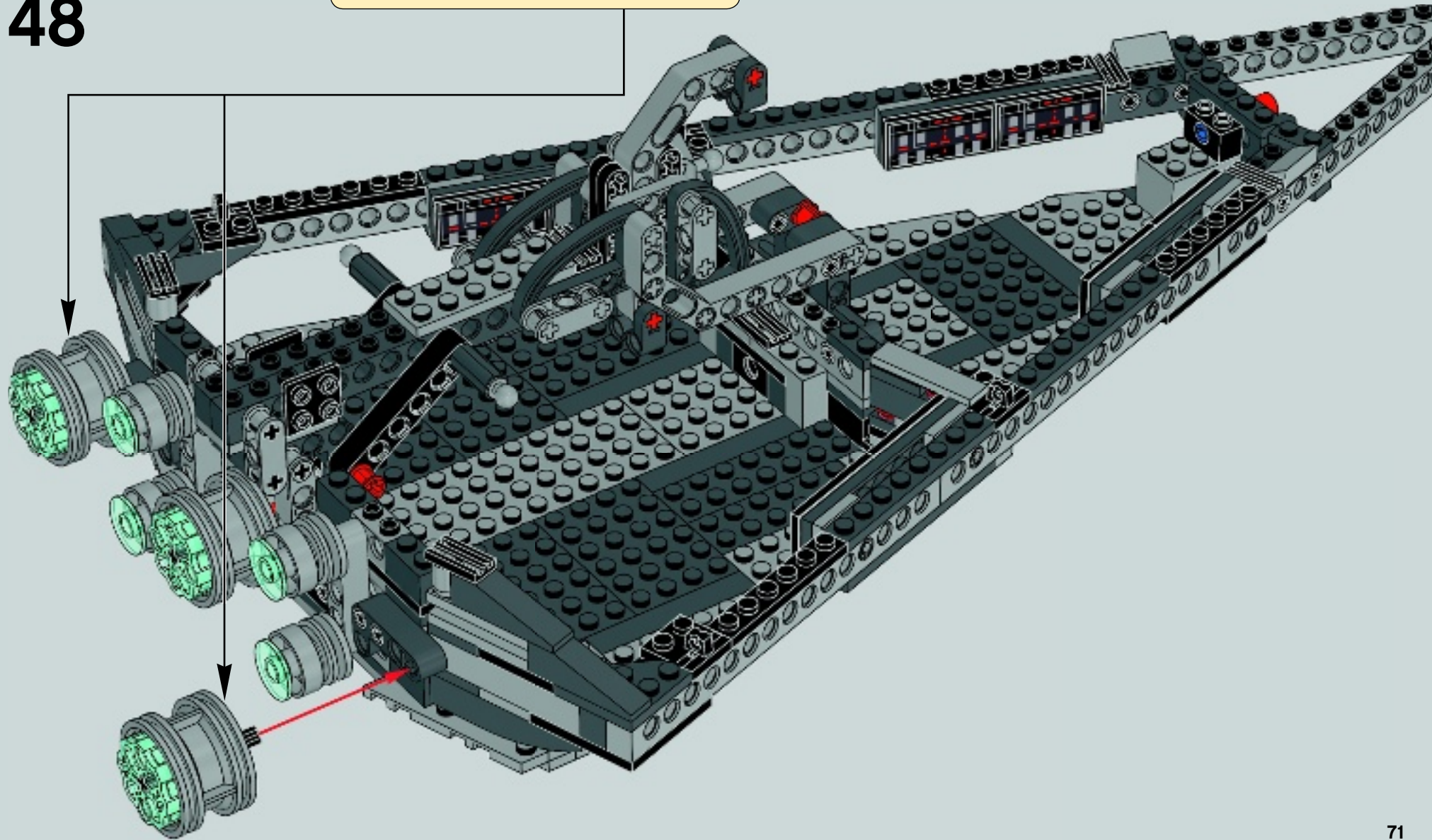



2x

49

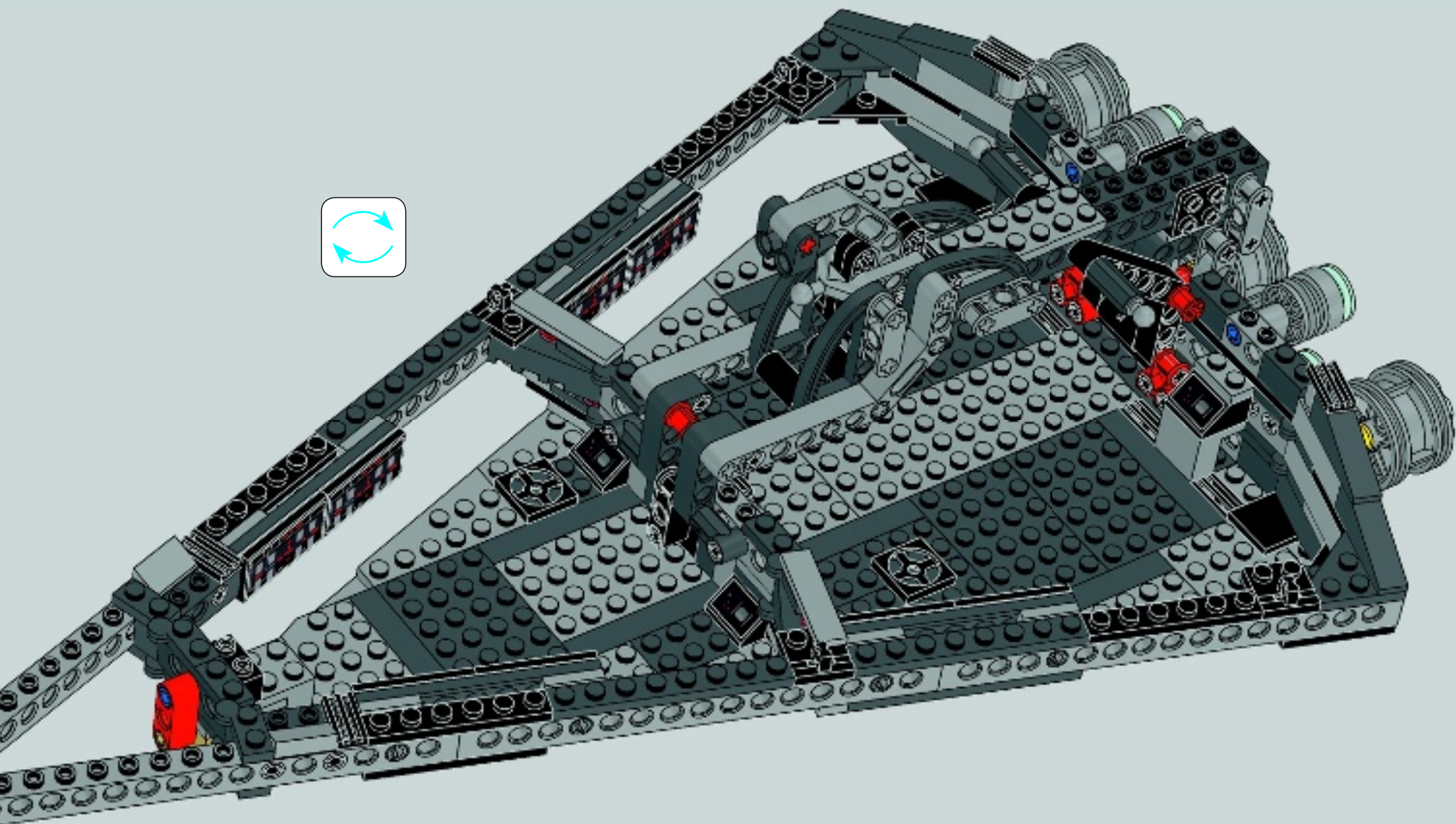
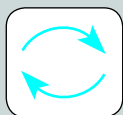



50

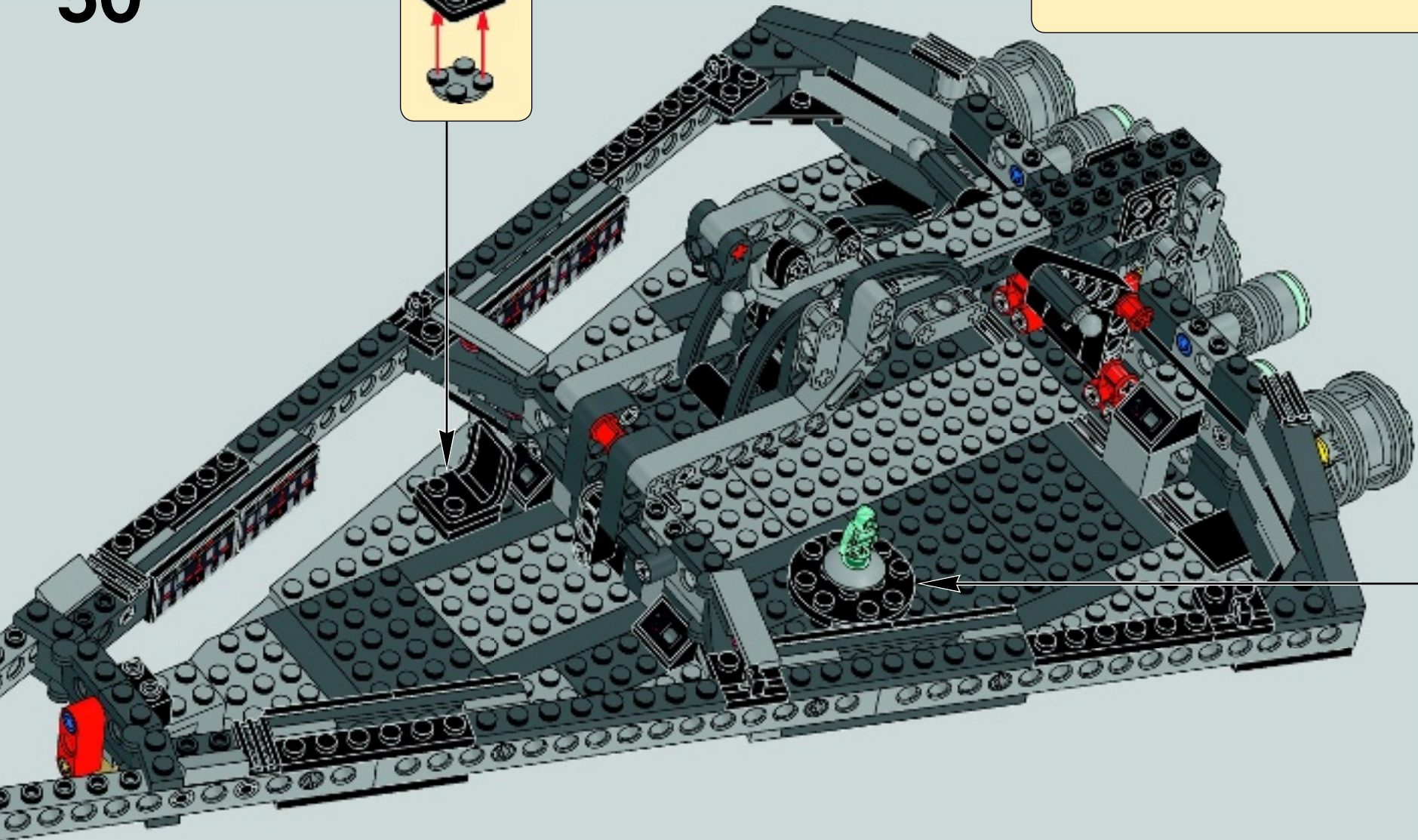
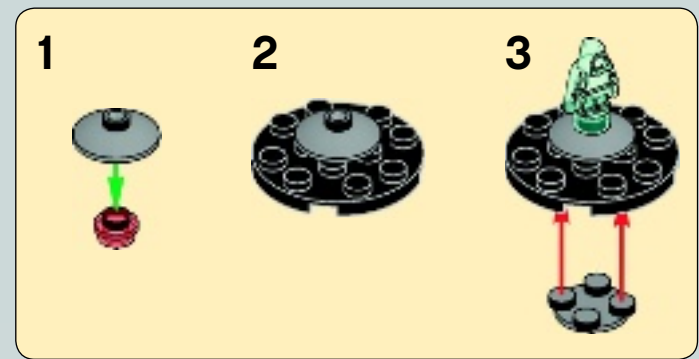

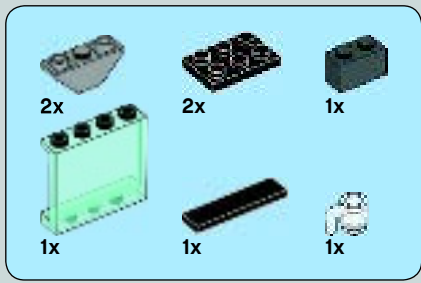

51

1

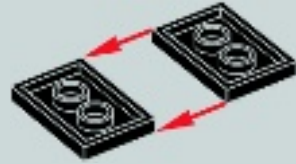

2

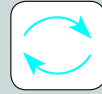

3

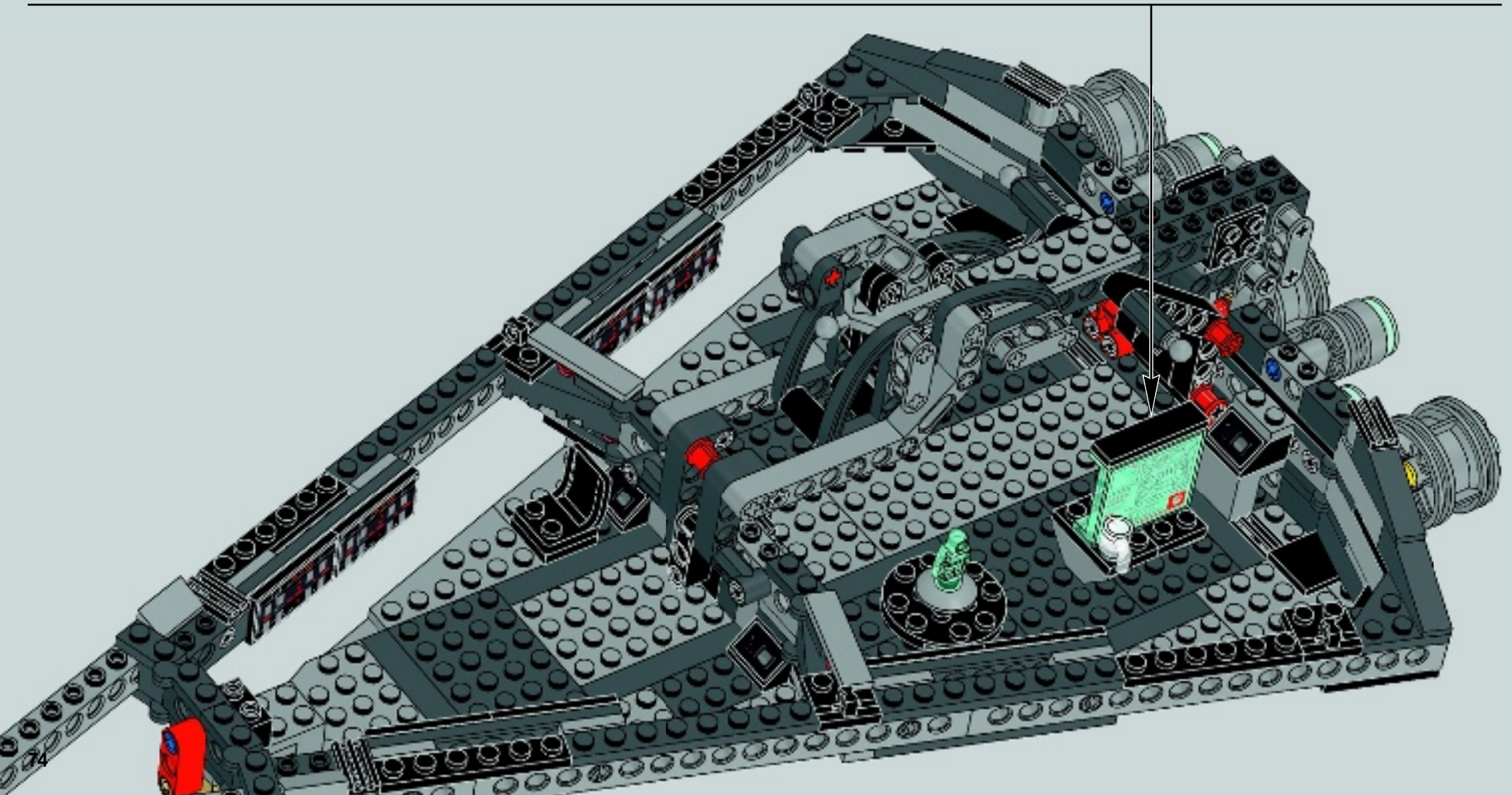
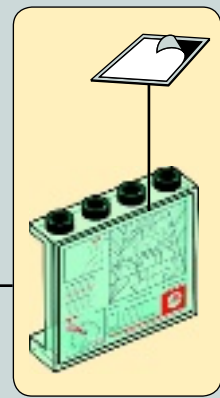
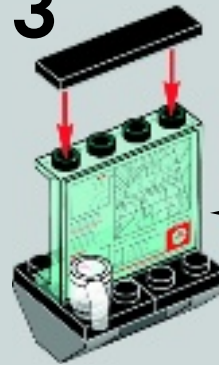



2x

52

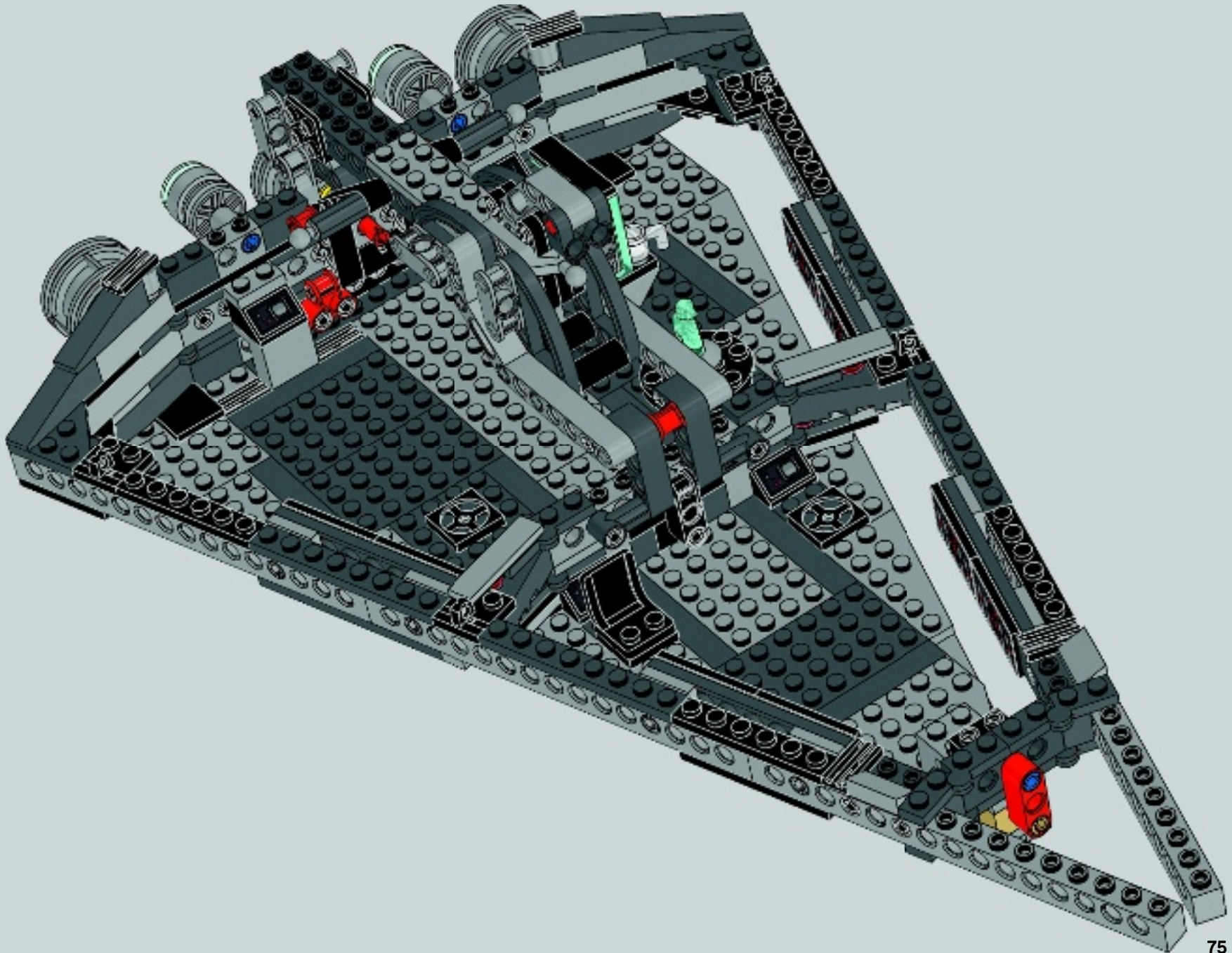

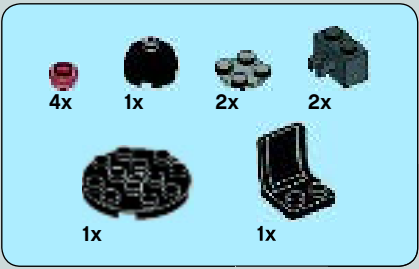

53

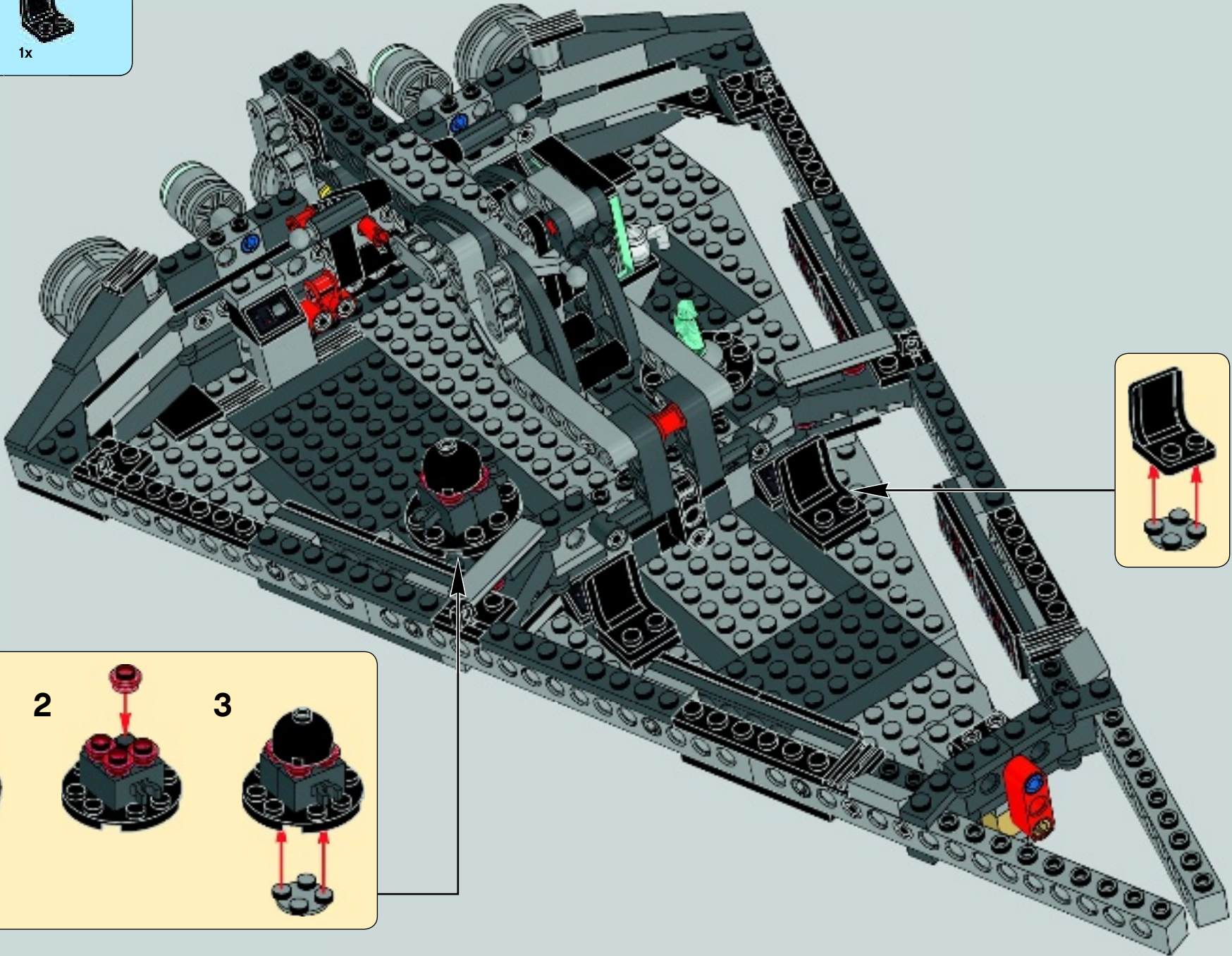

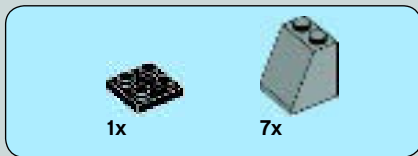

54

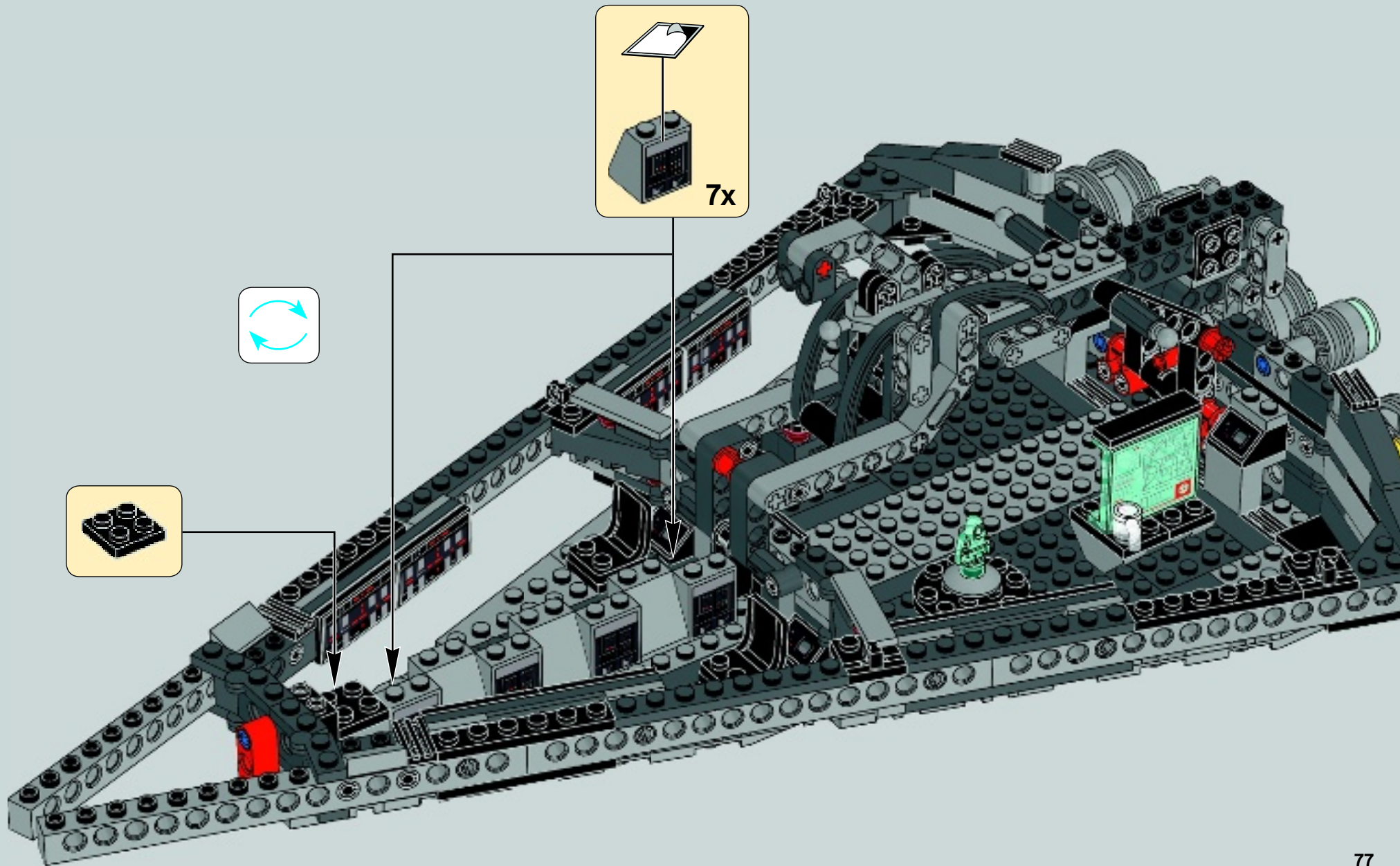

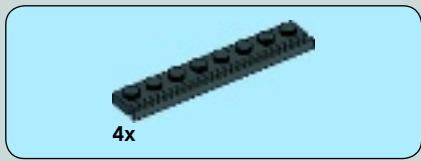

55

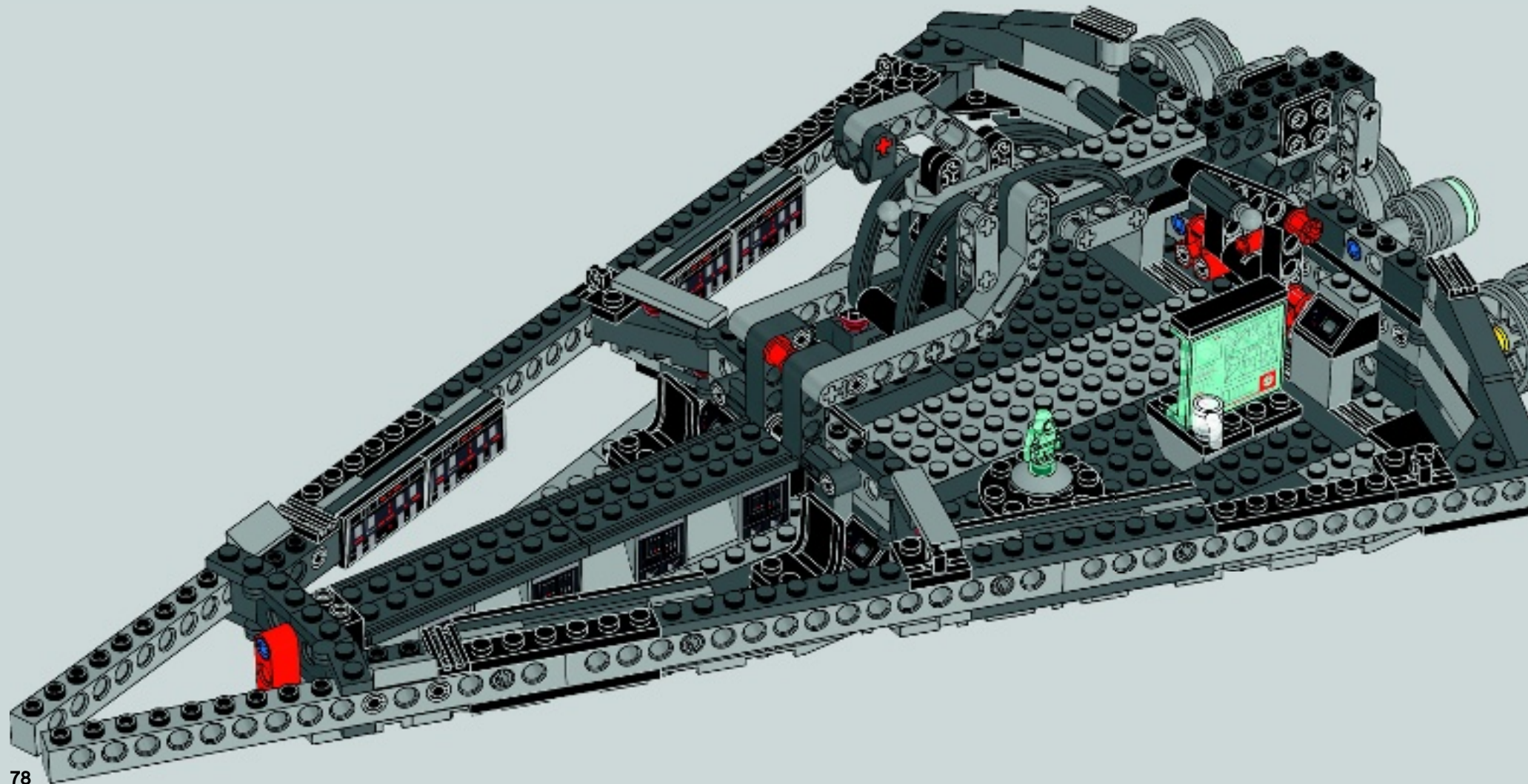



56

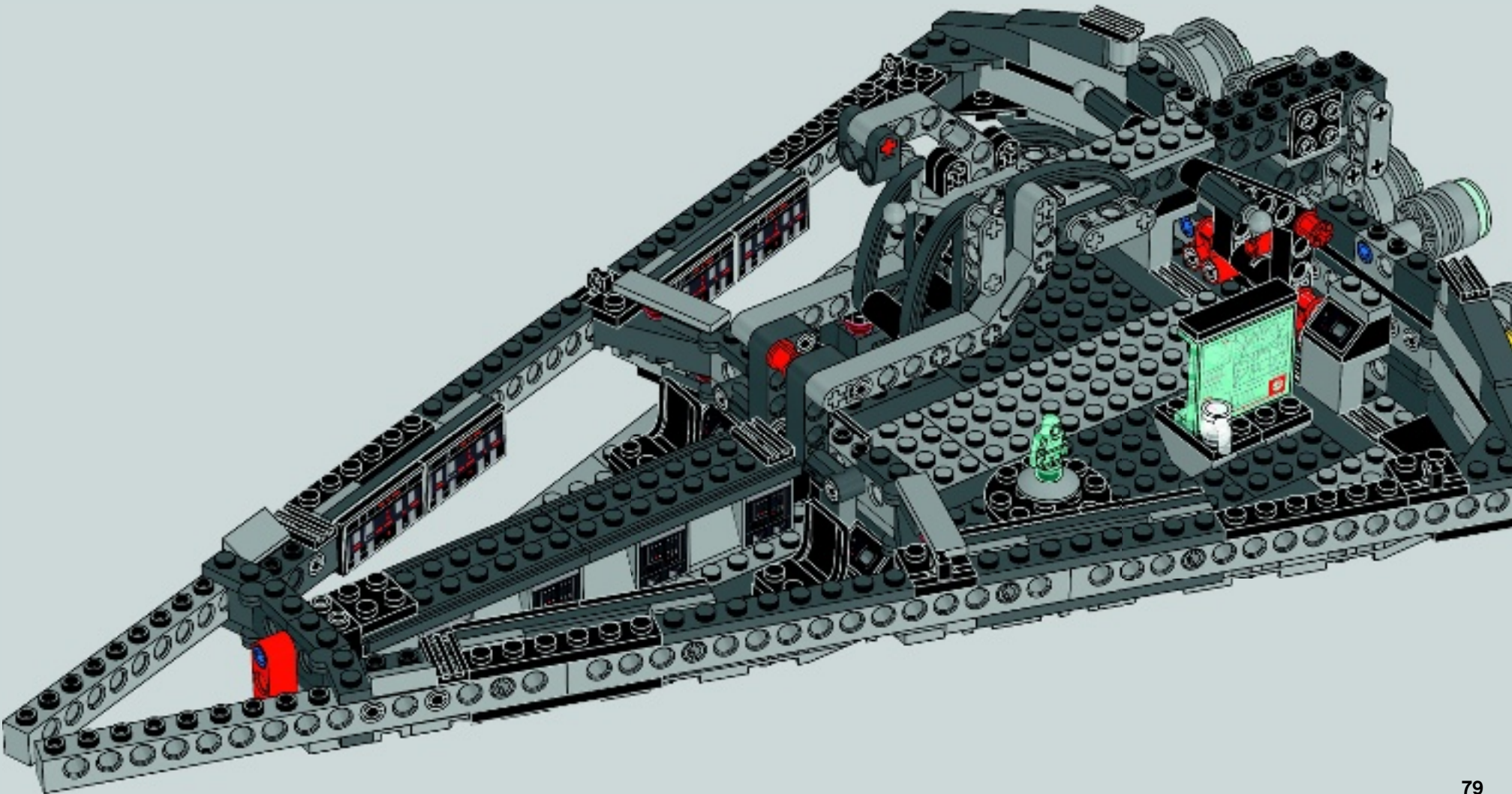



57

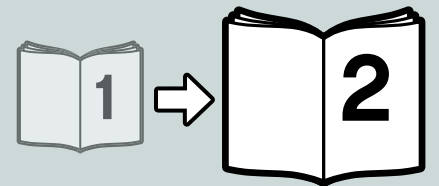
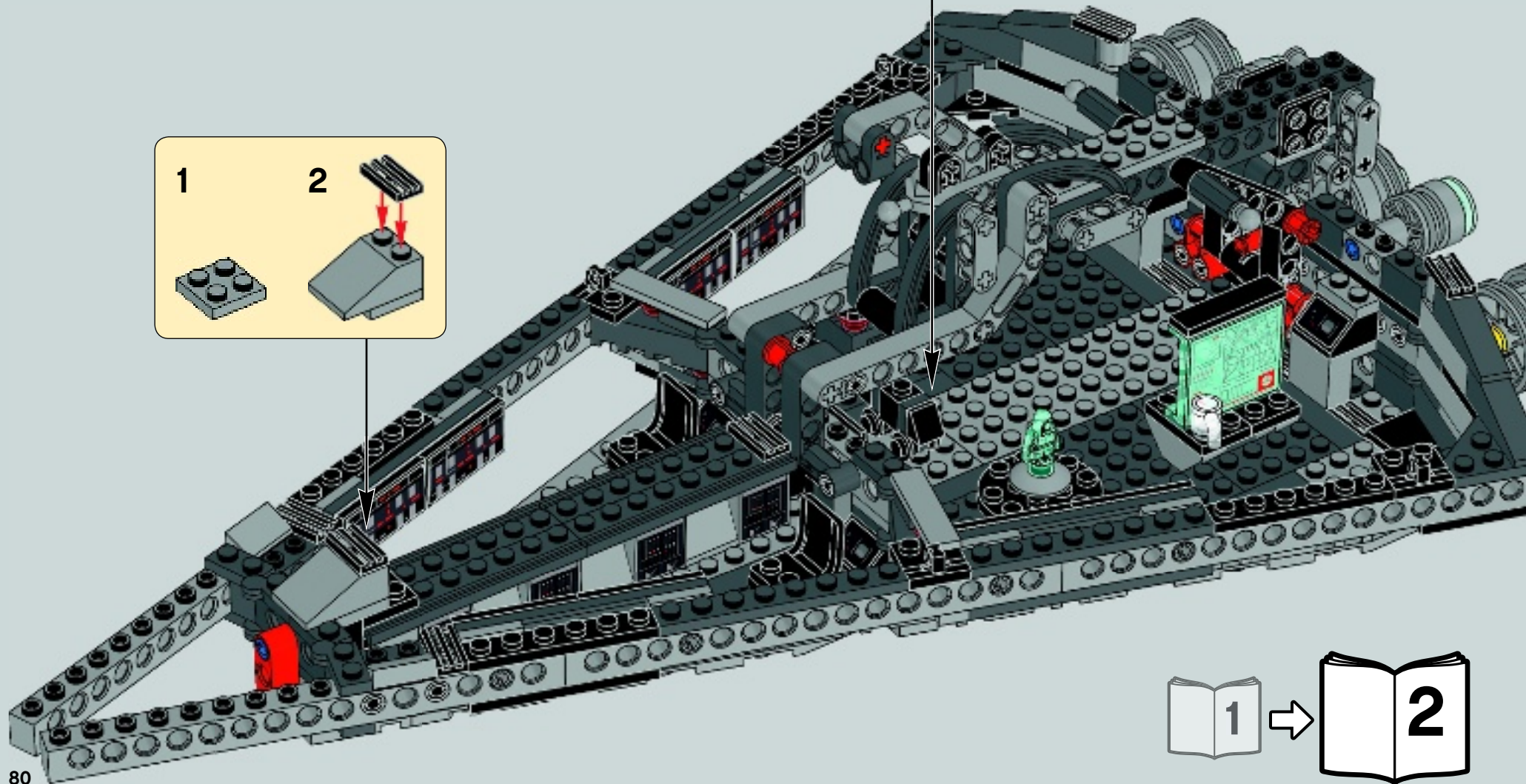
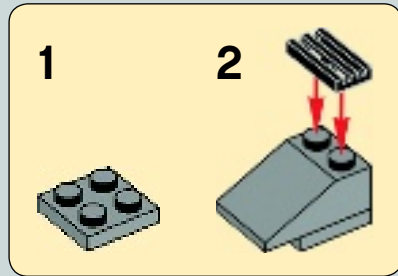



LEGO.com/starwars



75048



75049



75050



75051



75052



75053



75054



 LEGO.com/starwars

75055



POSTER
INSIDE

POSTER
INSIDE



75048



75048



75049, 75054



75049



75049



75050



75050



75050



75051



75051



75051



75051



75052



75052



75052



75052



75052



75052



75052



75052



75053



75053



75053



75053



75054



75054



75054



75055



75055



75055



75055



75055



75058



75058



75058



75058



75058



75058



GO TO WWW.LEGO.COM/PRODUCTFEEDBACK AND GIVE US YOUR SHORT **FEEDBACK** ABOUT THIS LEGO® SET FOR A CHANCE TO WIN A COOL LEGO PRIZE.

LEGO.com/productfeedback

GEWINNE



Erzähle uns auf www.LEGO.com/productfeedback

etwas über die Erfahrungen, die du mit diesem LEGO® Set gemacht hast, und sichere dir die Chance auf einen coolen LEGO Preis!

GAGNE



Rends-toi sur www.LEGO.com/productfeedback

et donne-nous quelques commentaires sur ce produit LEGO® pour avoir une chance de gagner un prix LEGO !

GANAN



Visita www.LEGO.com/productfeedback

y envíanos tu opinión acerca de este set LEGO®. ¡Participarás en el sorteo de un premio LEGO!

获取奖品



登录 www.LEGO.com/productfeedback

给出关于此乐高®套装的简短反馈，就有机会获得炫酷乐高奖品

경품 당첨 기회



www.LEGO.com/productfeedback

페이지로 이동하여 이 레고® 세트에 대한 간략한 피드백을 보내 주시고 멋진 레고 경품을 탈 수 있는 기회도 잡으십시오

ЗАПОЛНИ АНКЕТУ И ПОЛУЧИ ПРИЗ



Перейди по ссылке www.LEGO.com/productfeedback

ответь всего на несколько вопросов об этом наборе LEGO®, и у тебя появится шанс выиграть замечательный приз от компании LEGO.