

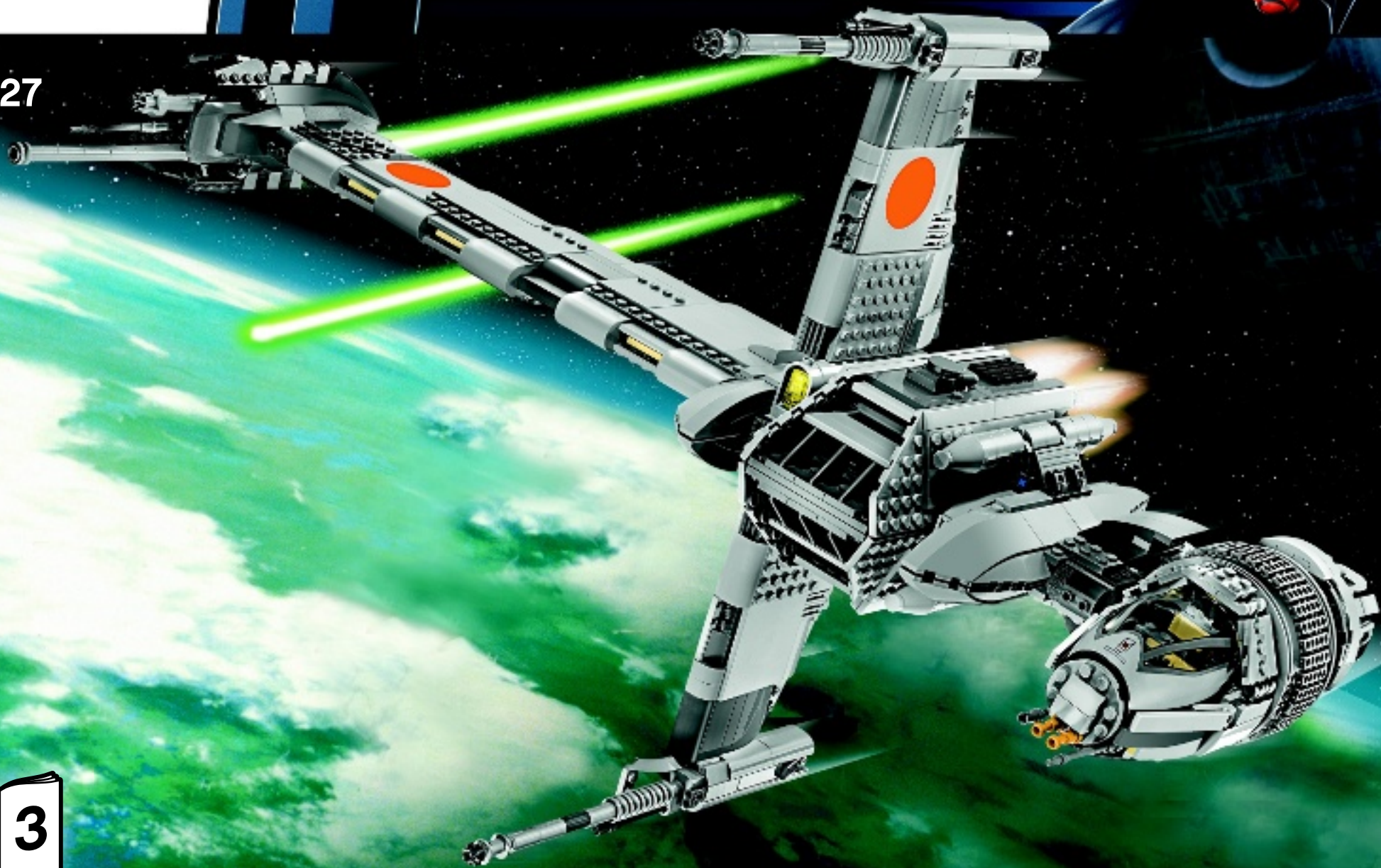

STAR WARS

10227

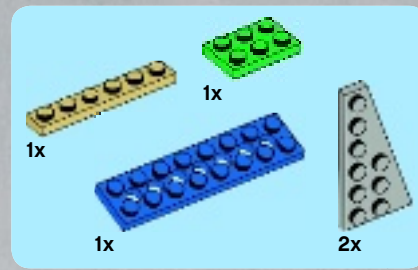

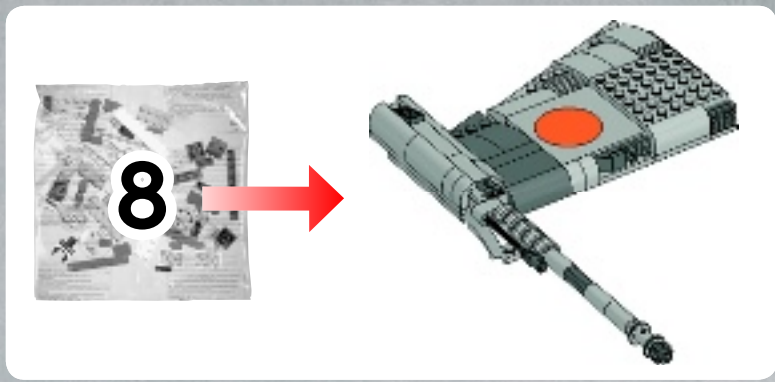

2

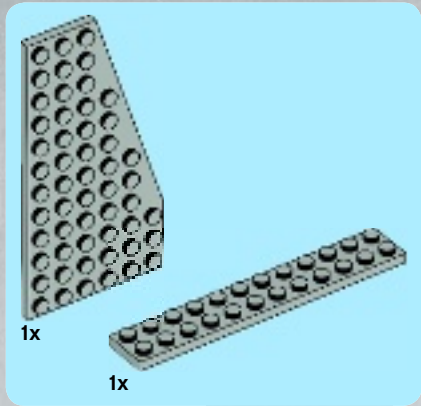

1

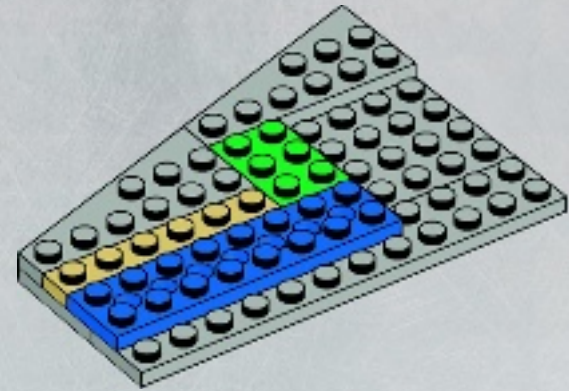
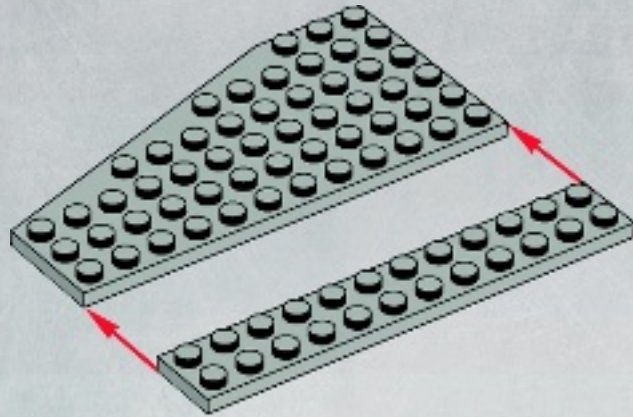

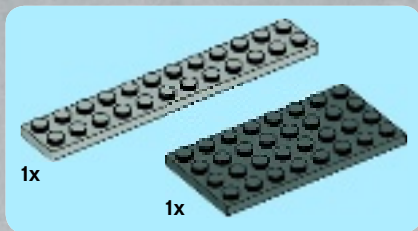

3

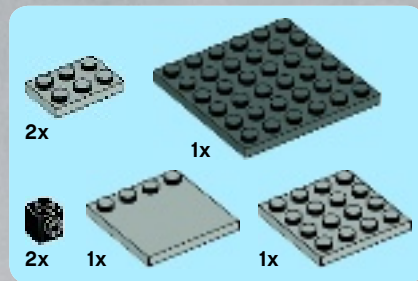
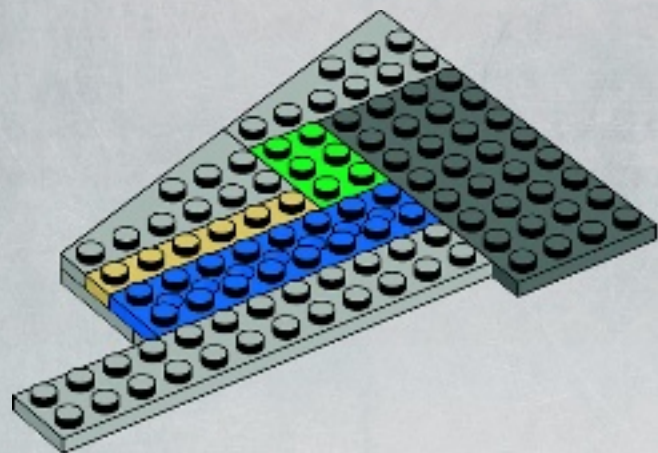

4

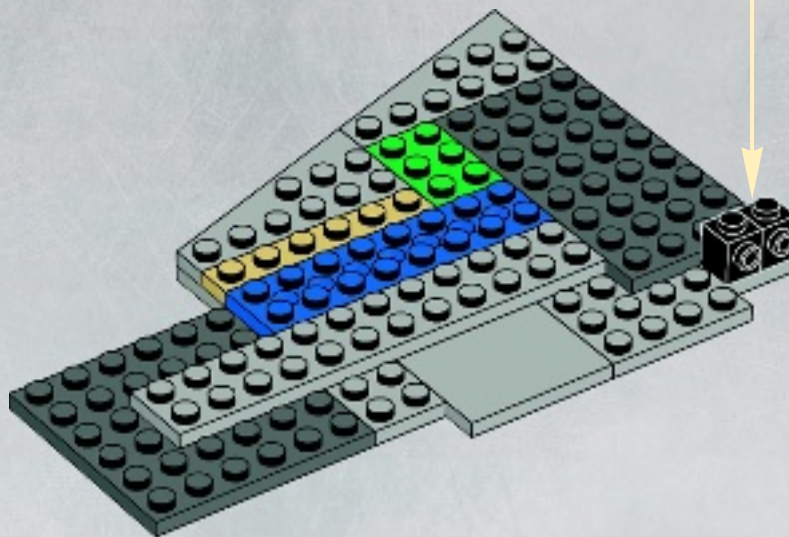
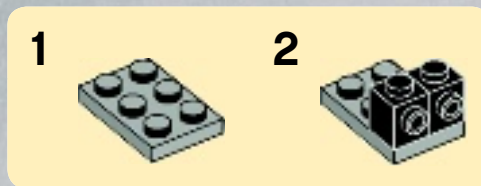

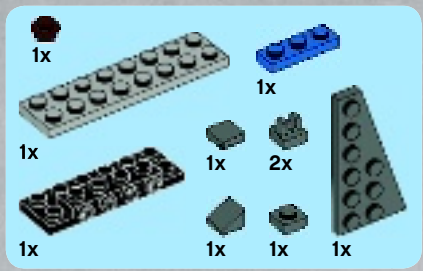

5

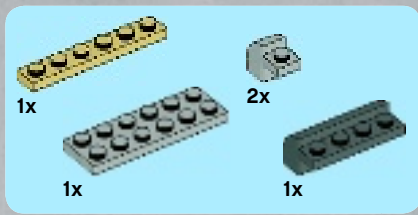
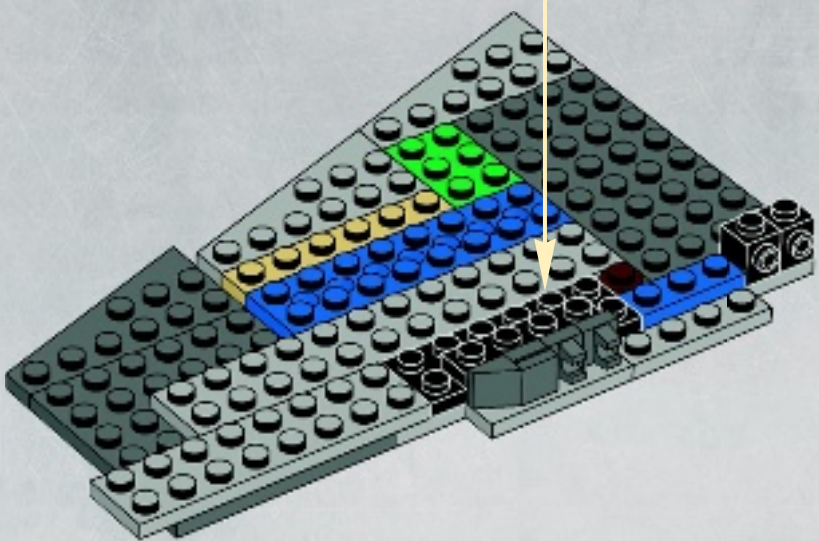
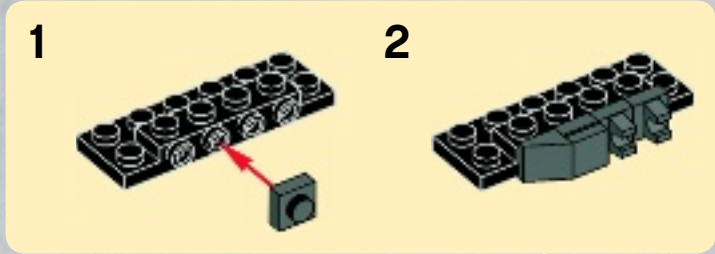

6

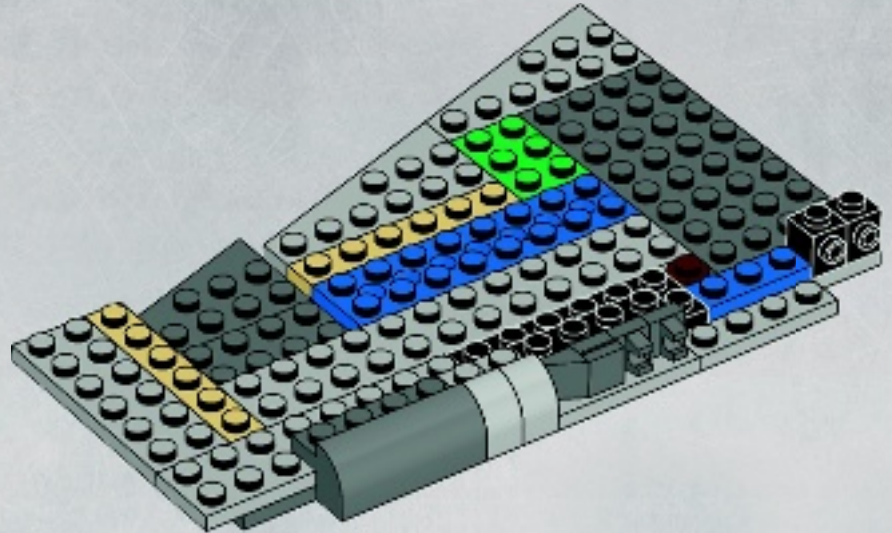

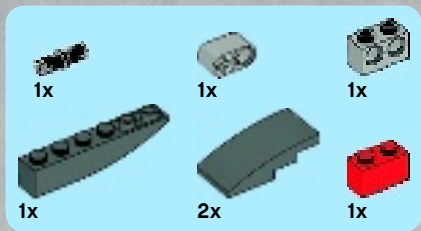

9

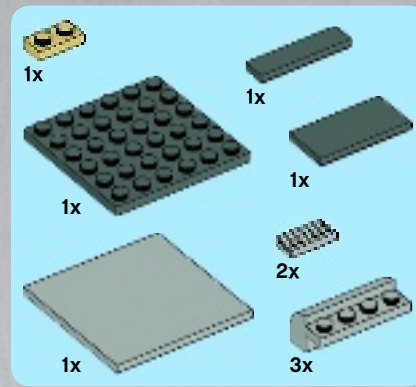
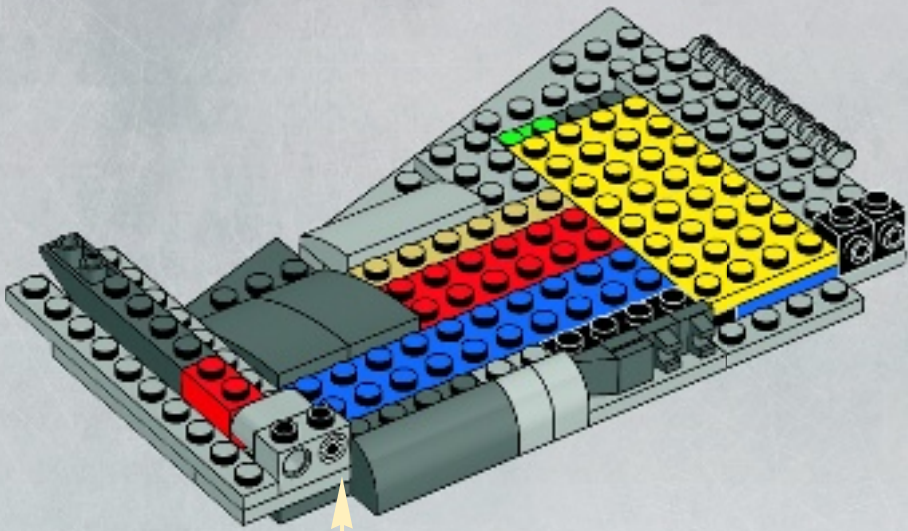

10

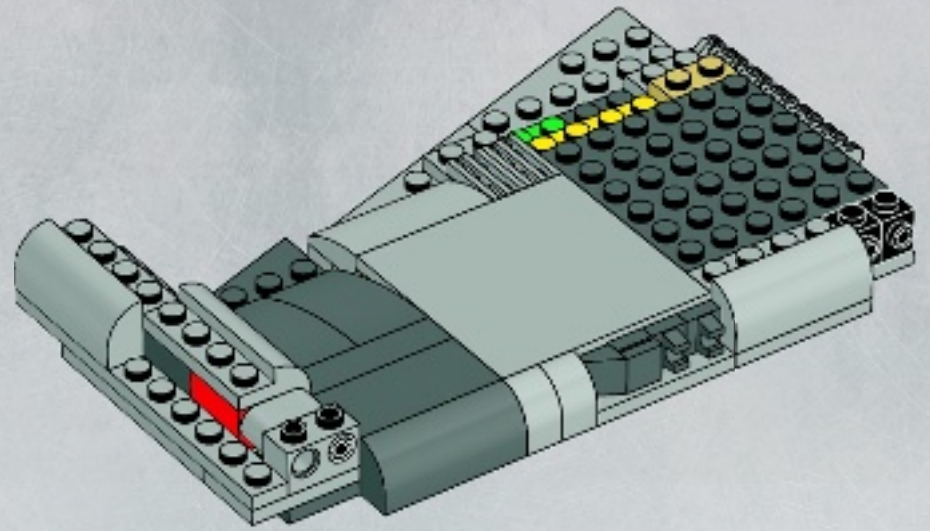

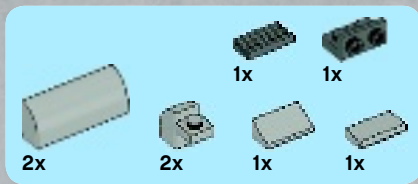

11

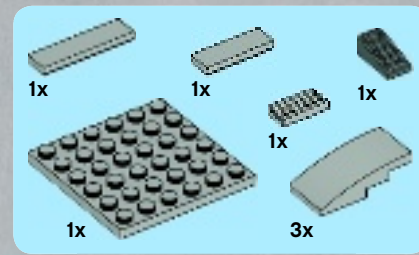
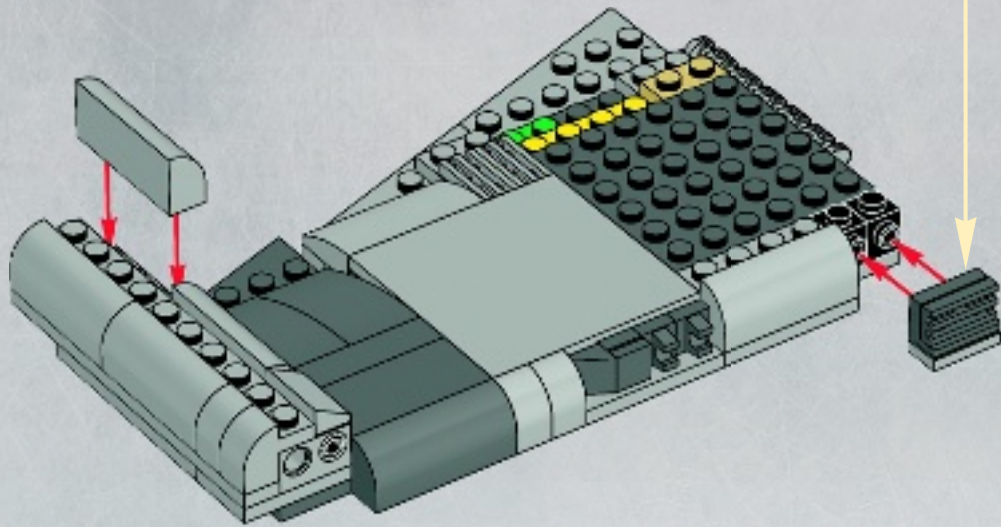
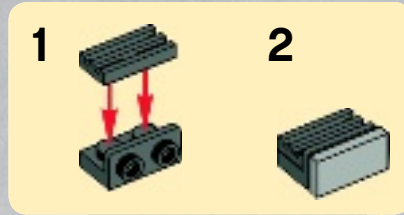

12

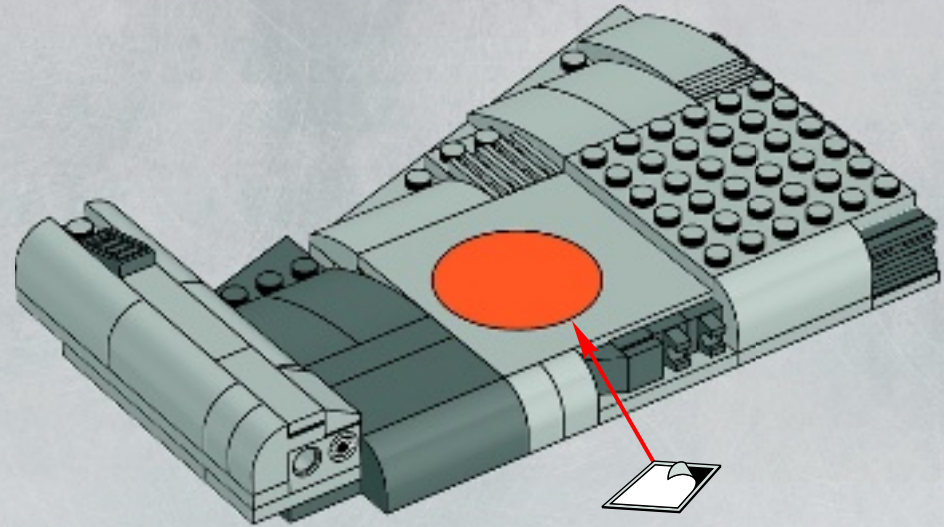

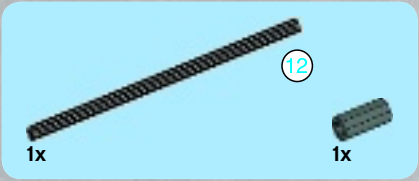

1

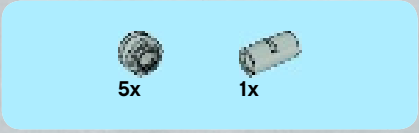
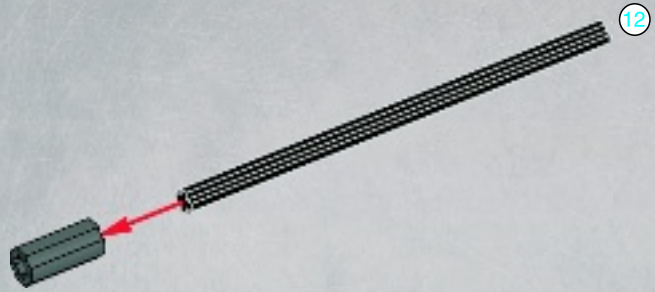

2

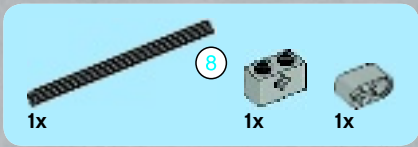
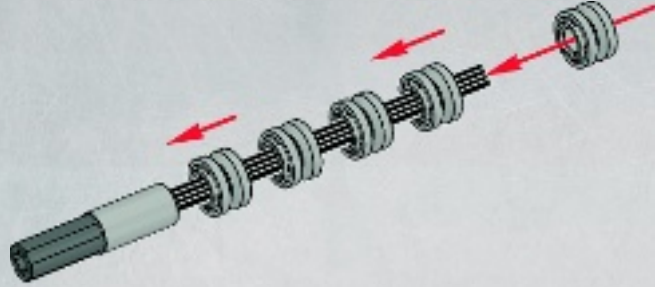

3

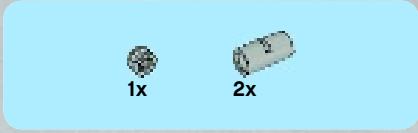
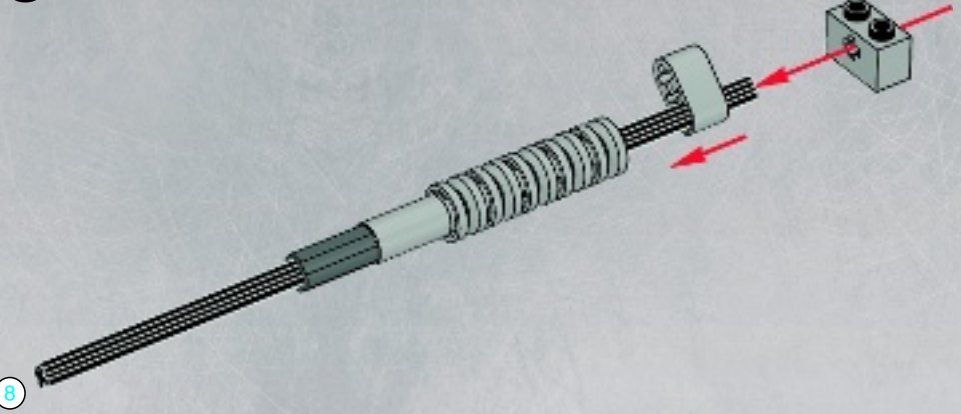

4

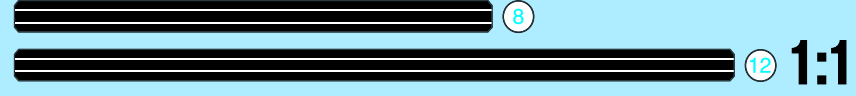
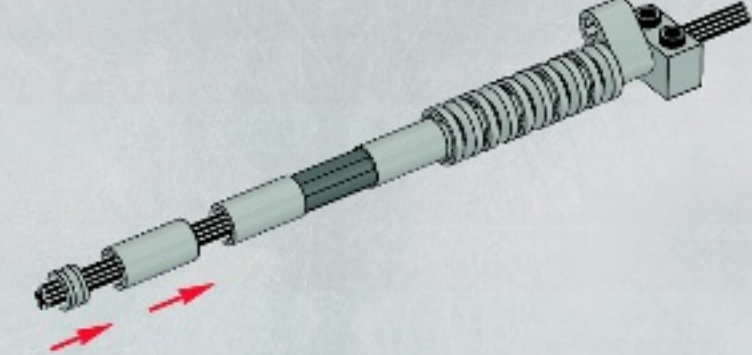

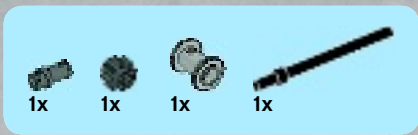

5

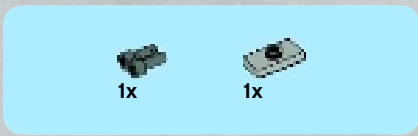
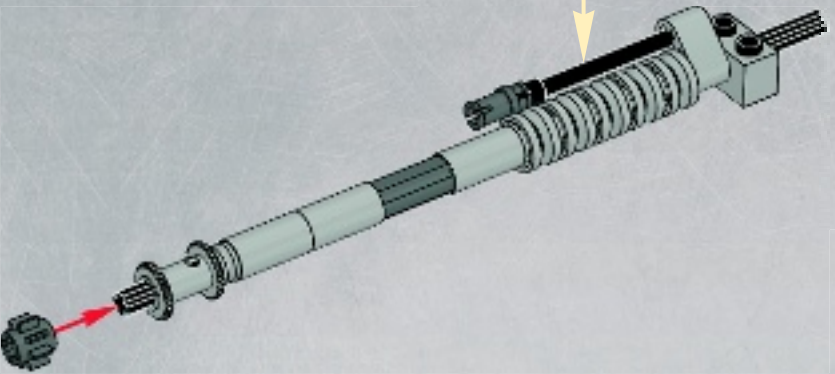

6

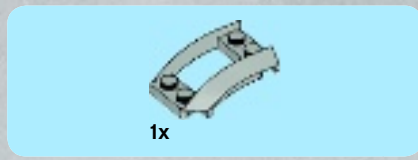
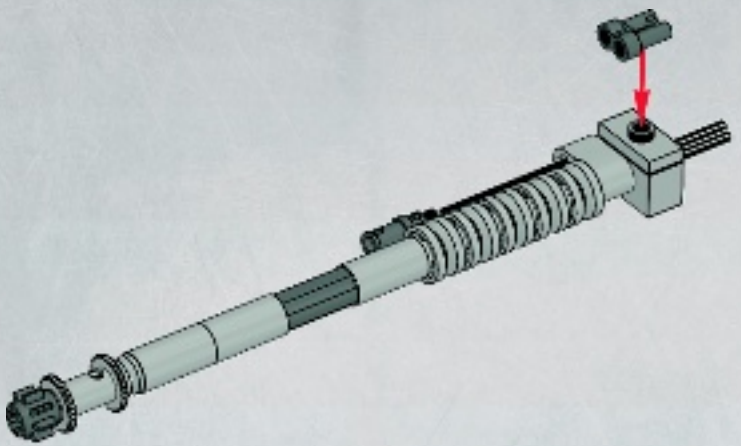

7

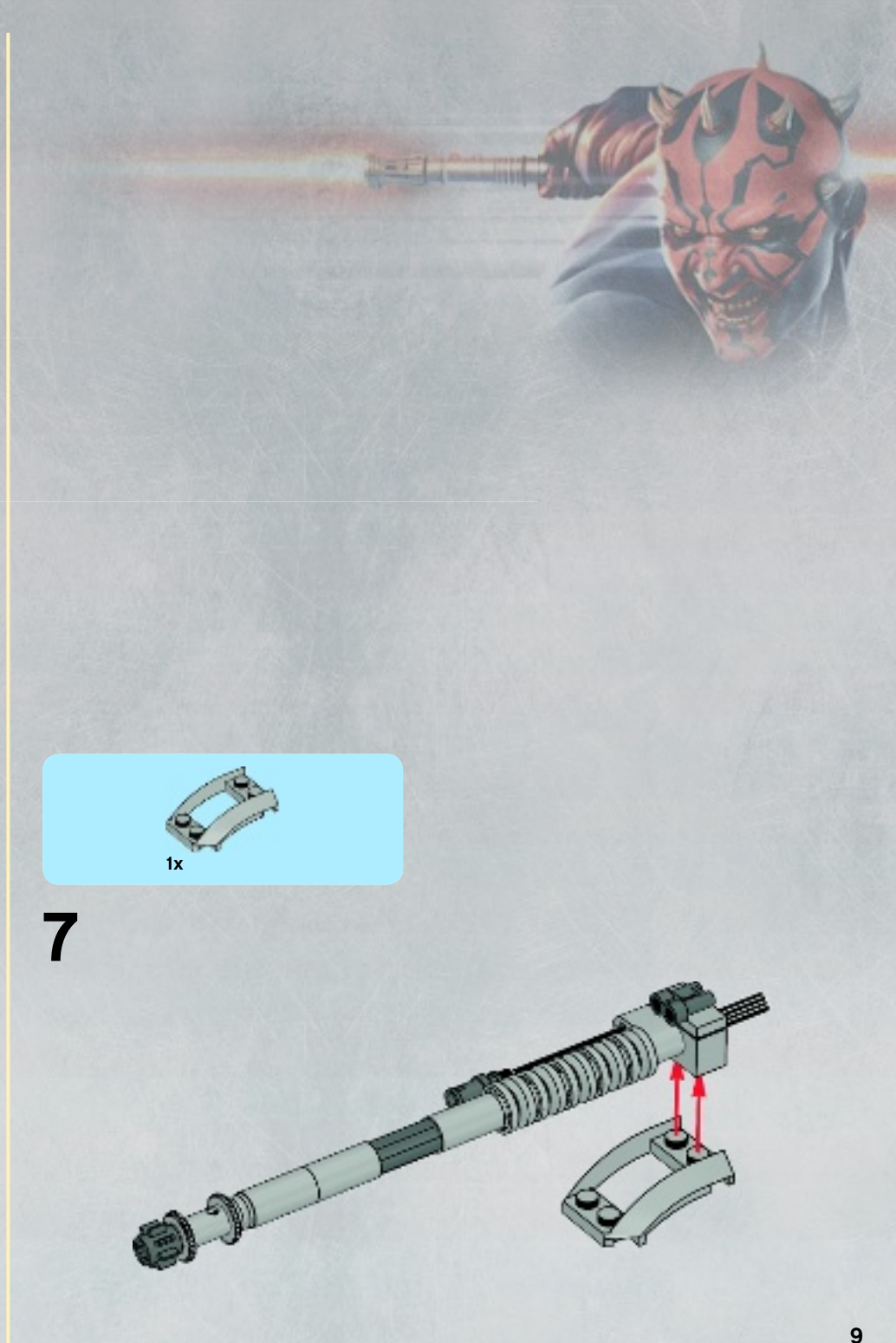
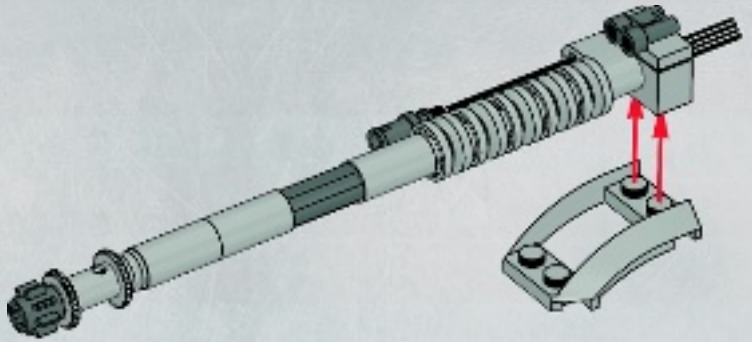

13

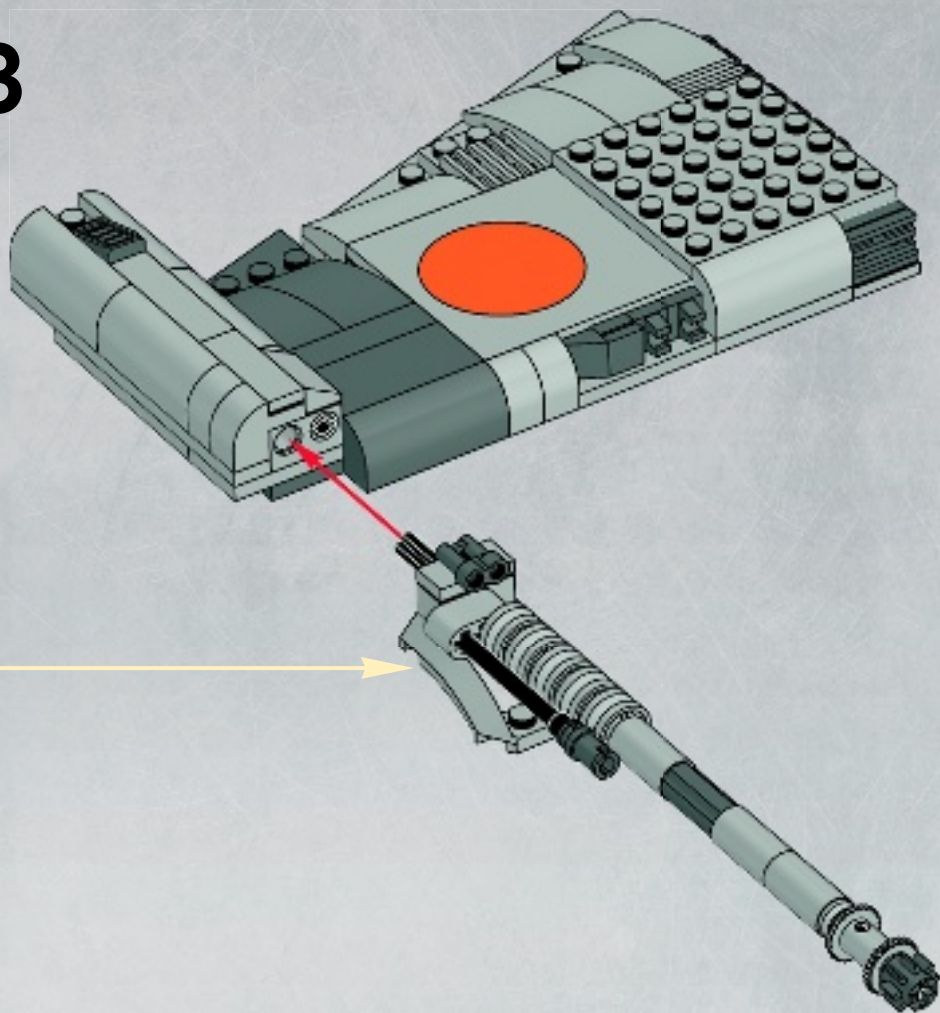

14

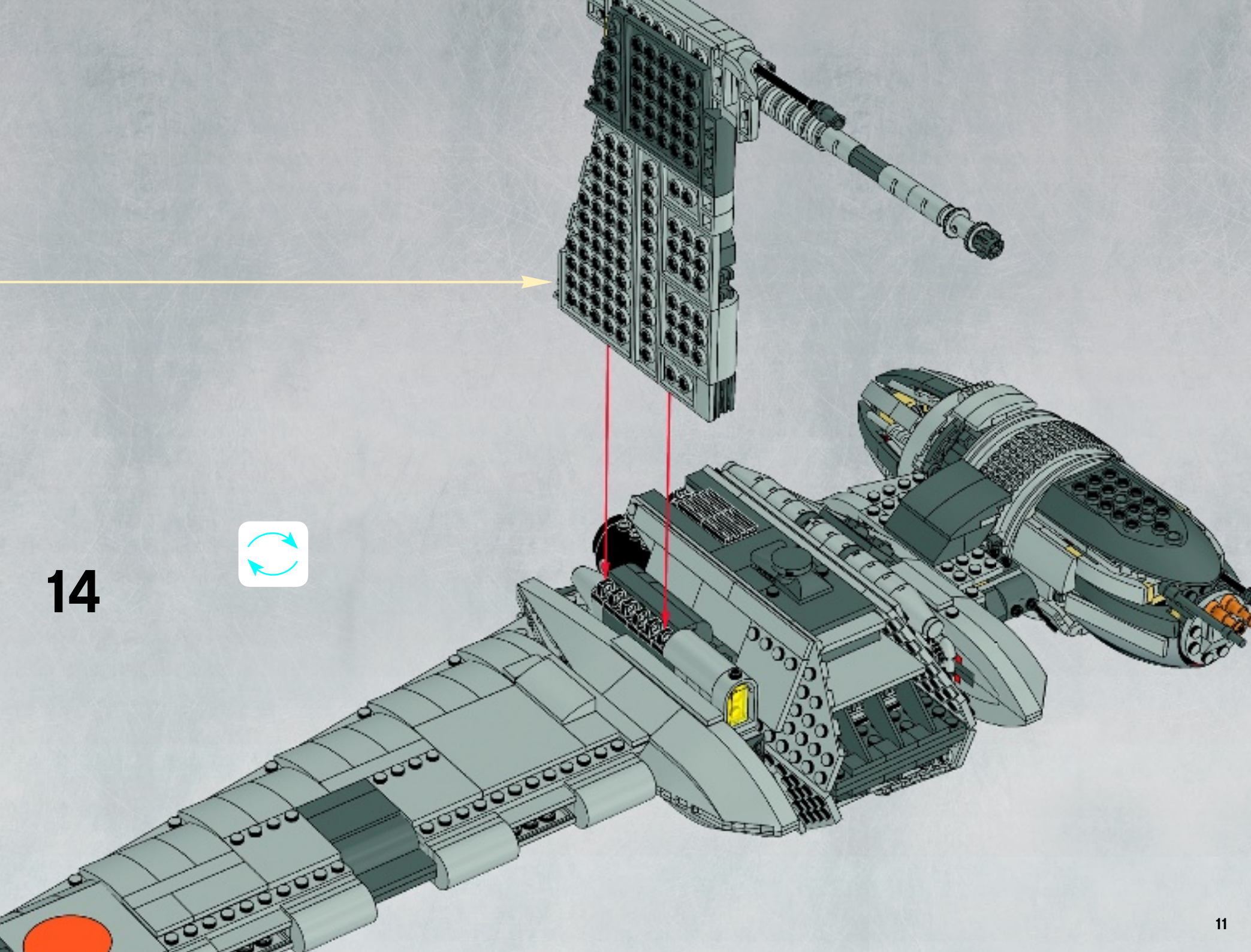

15

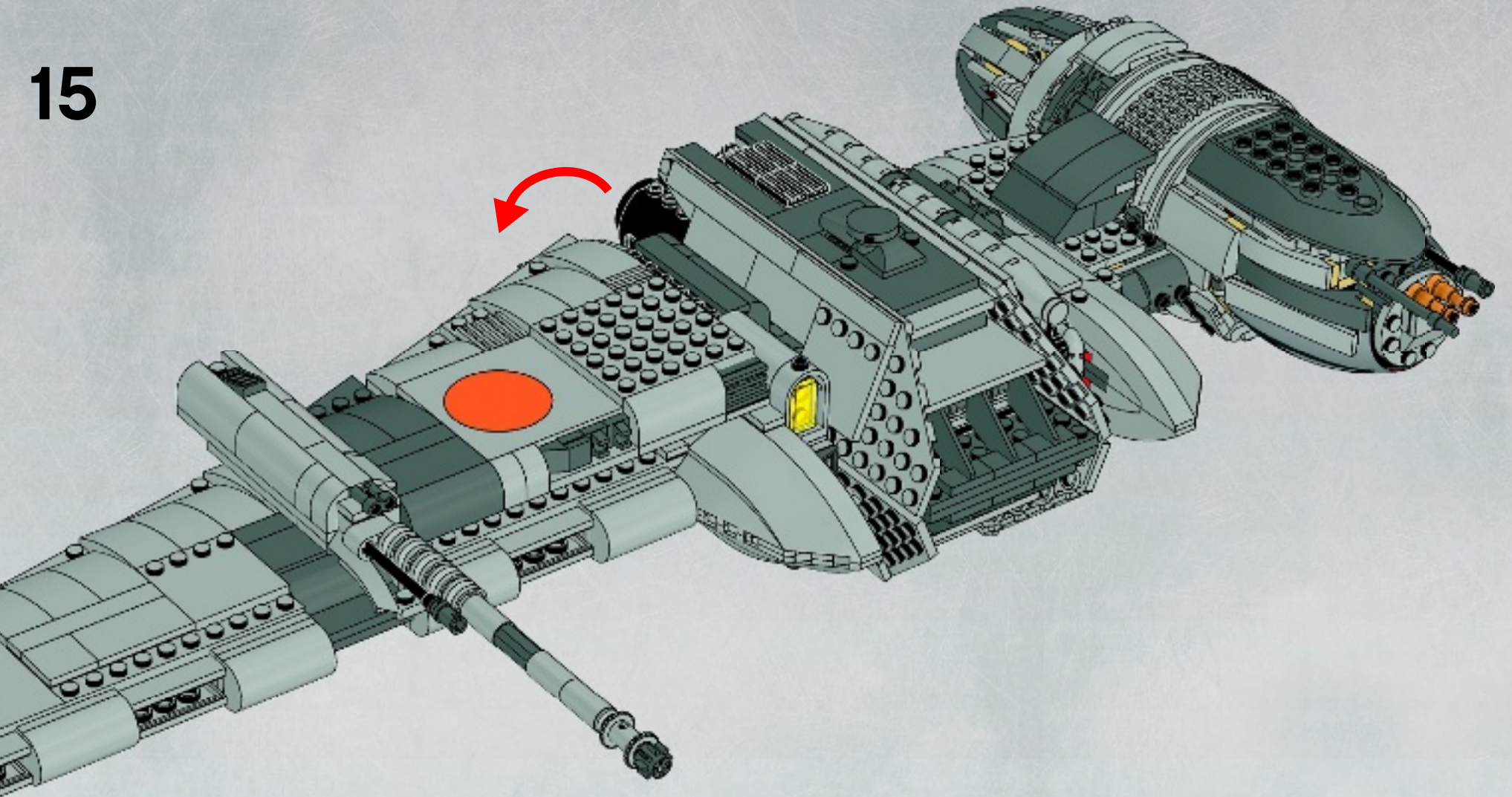

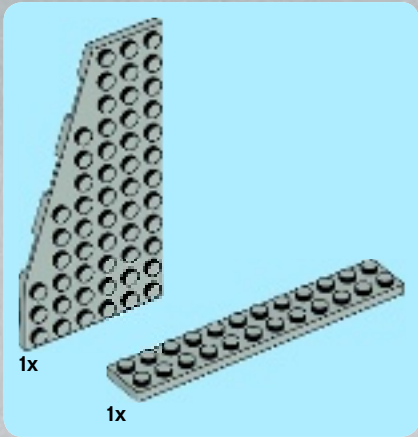
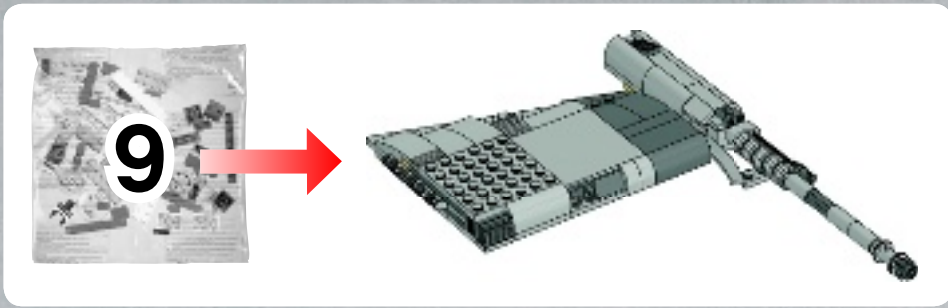

1

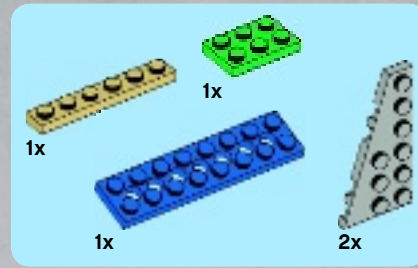
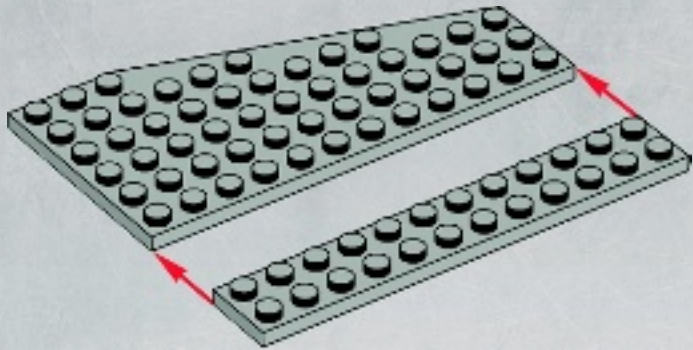

2

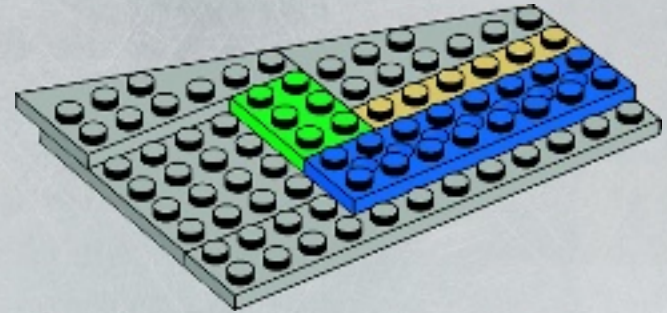

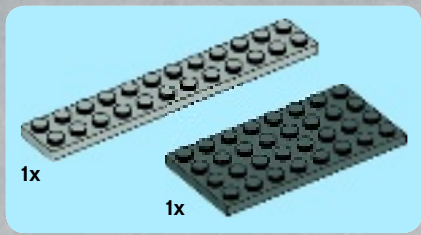

3

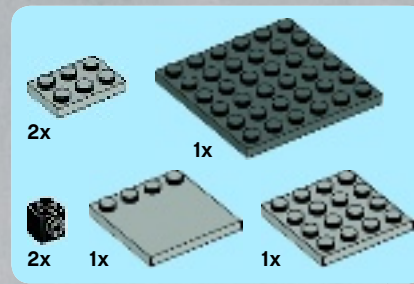
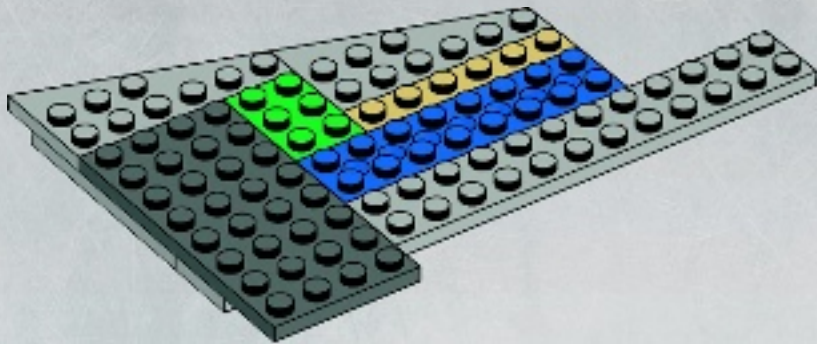

4

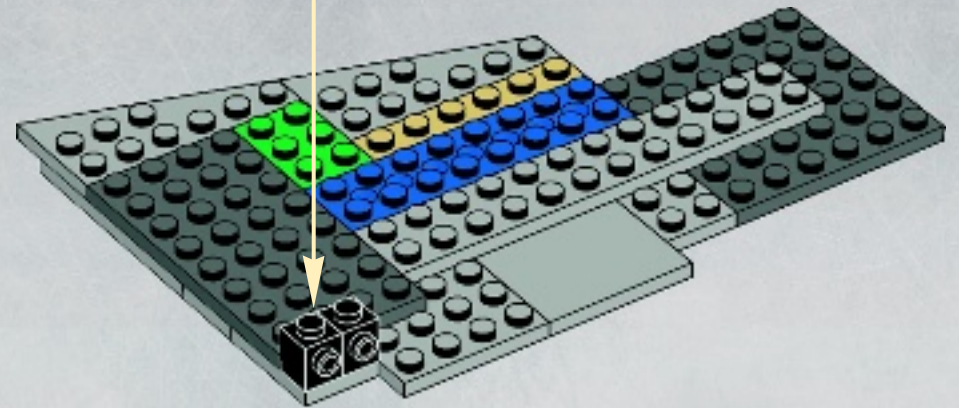
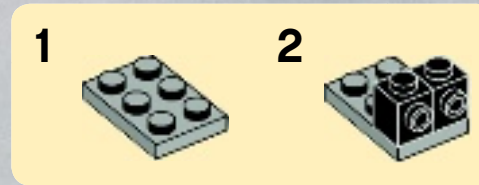

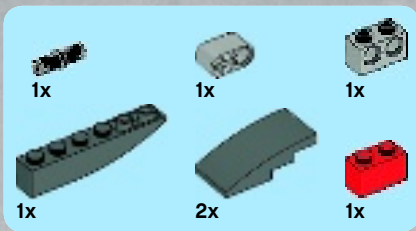

9

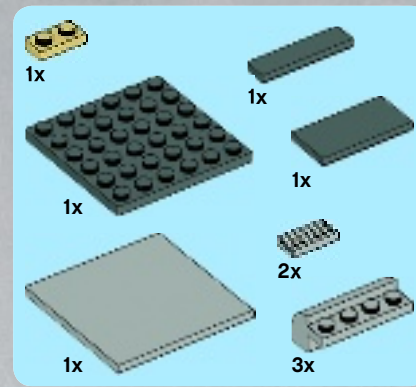
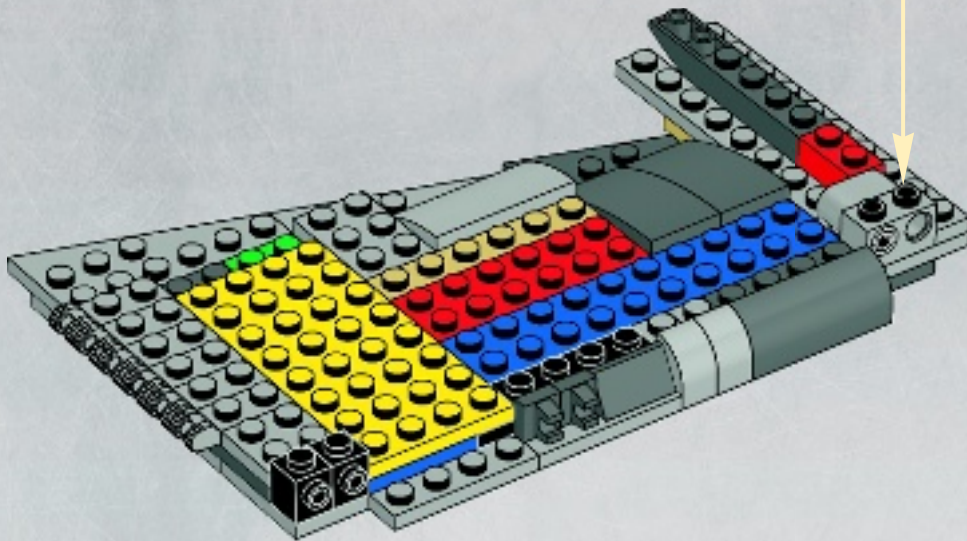
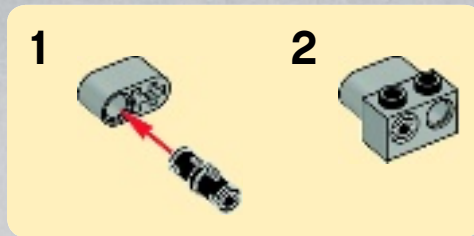

10

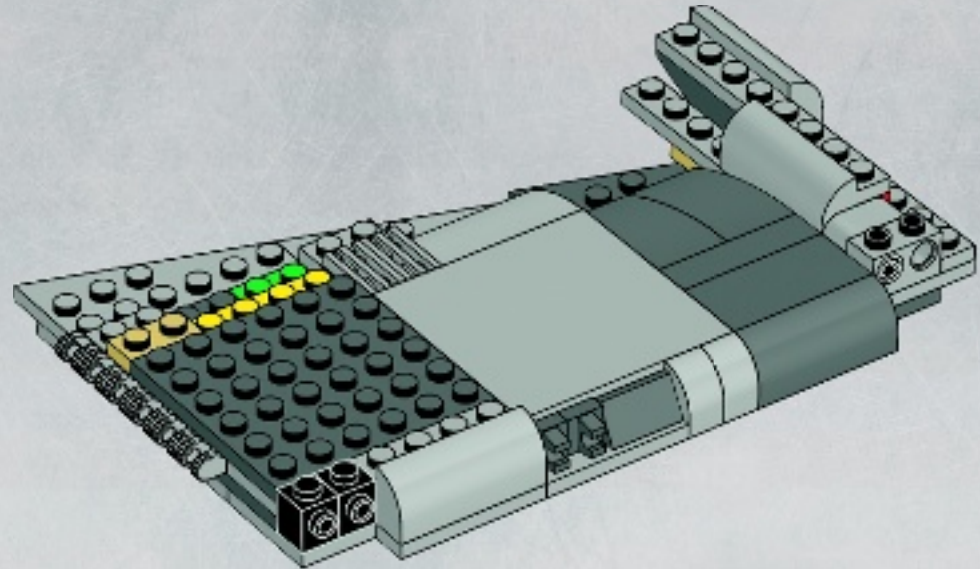

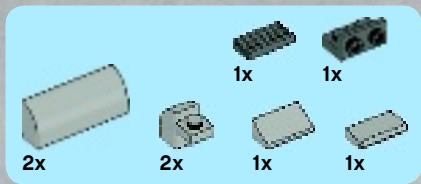

11

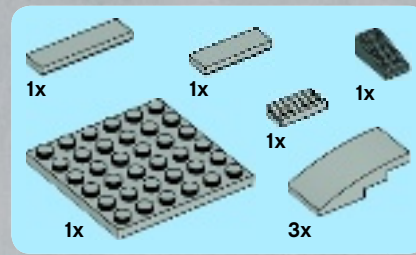
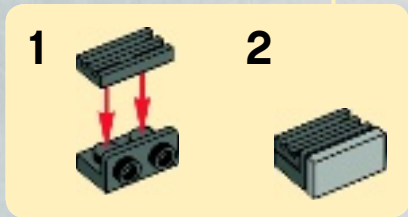
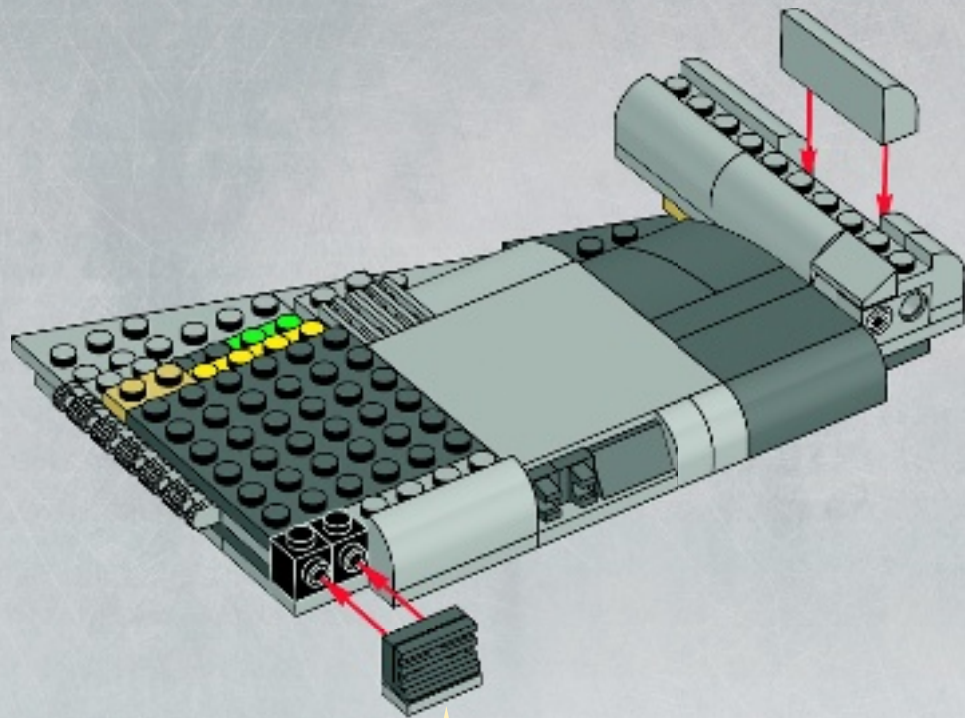

12

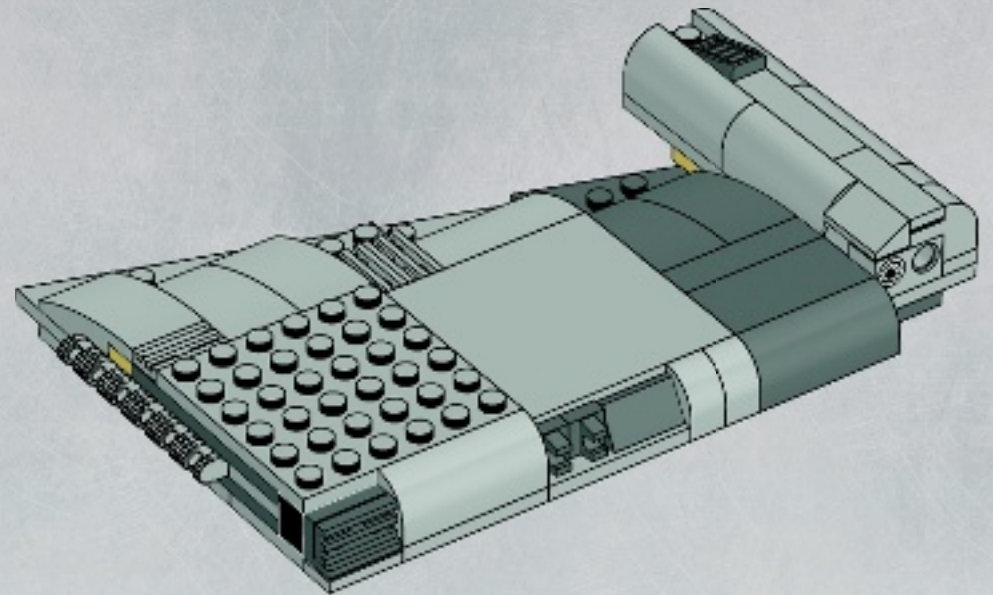

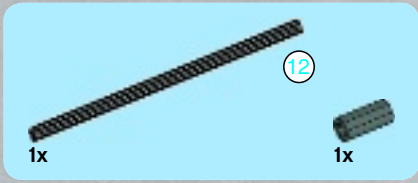

1

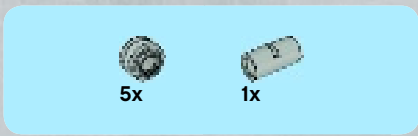
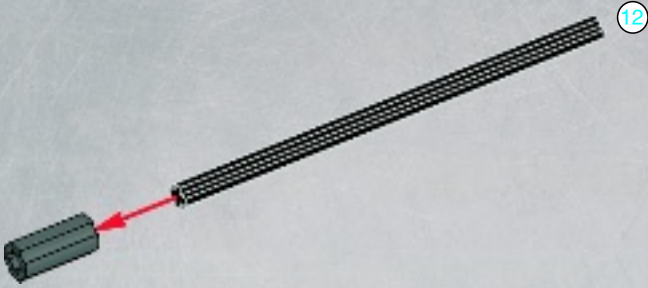

2

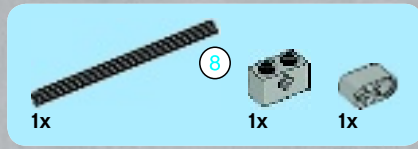
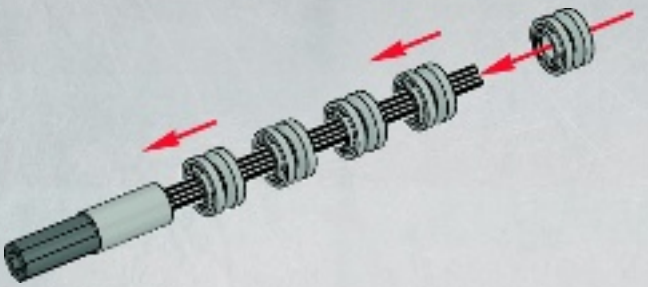

3

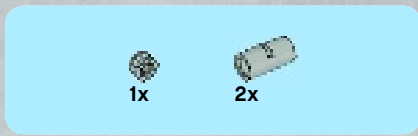
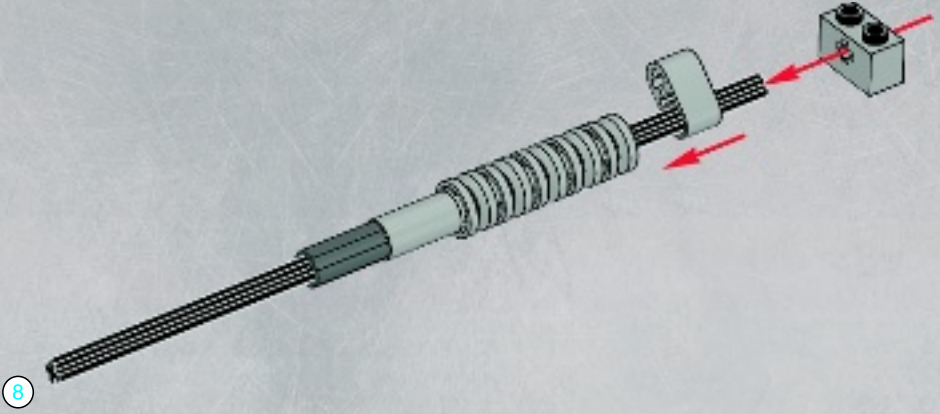

4

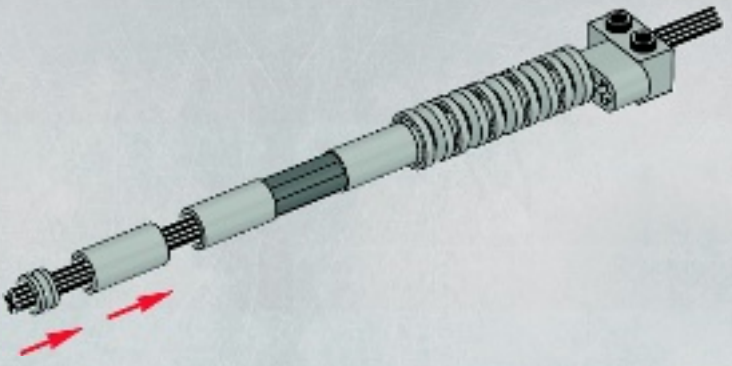



5

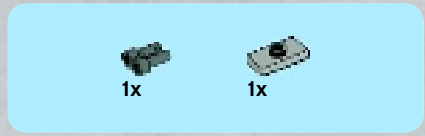
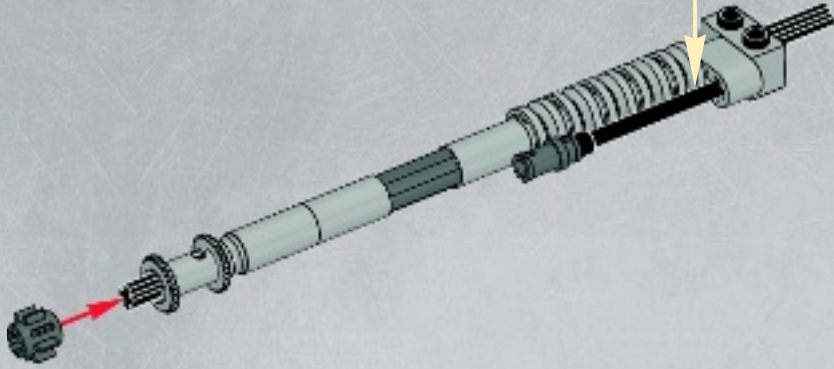

6

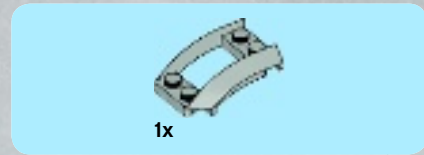
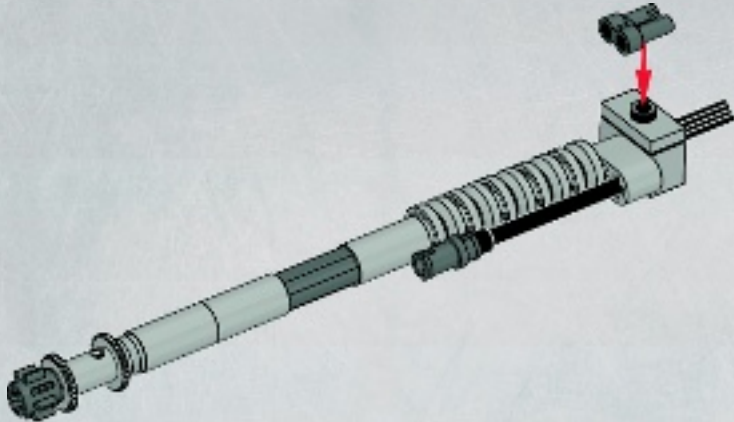

7

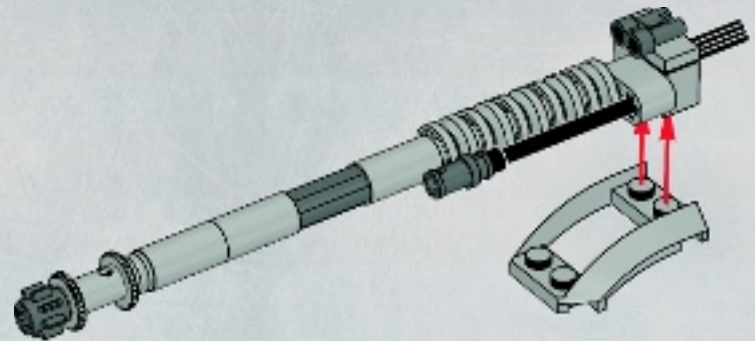

13

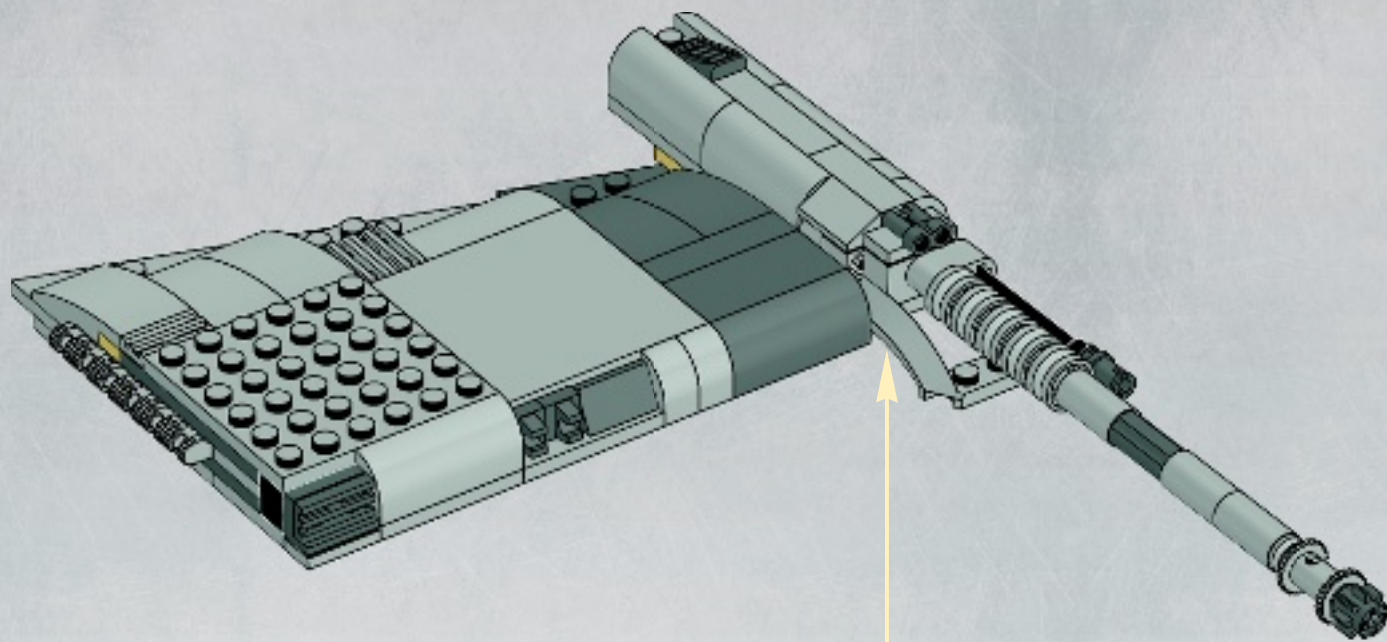



14

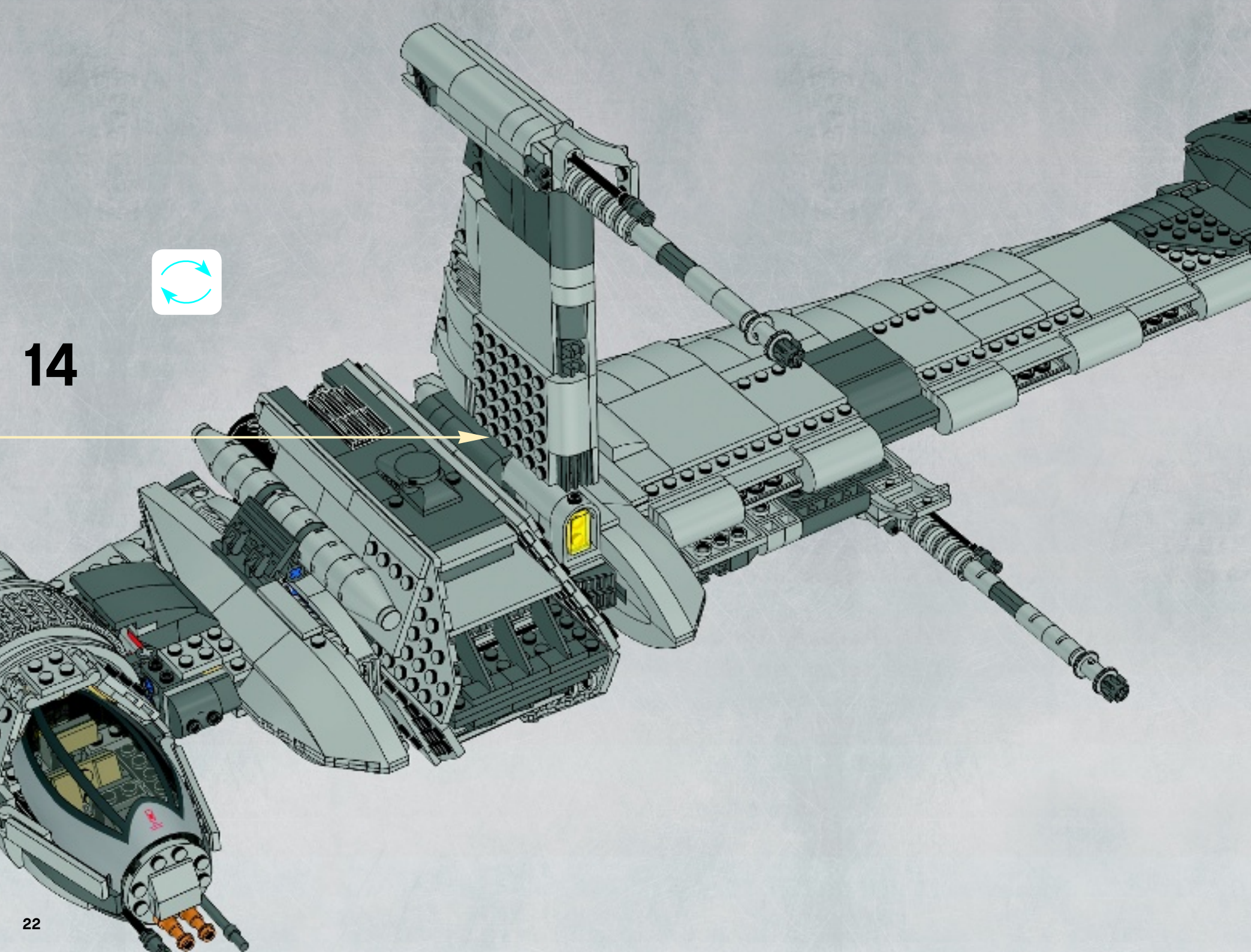

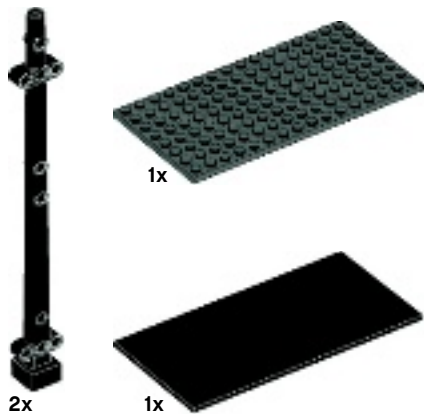

+



1x



2x

1

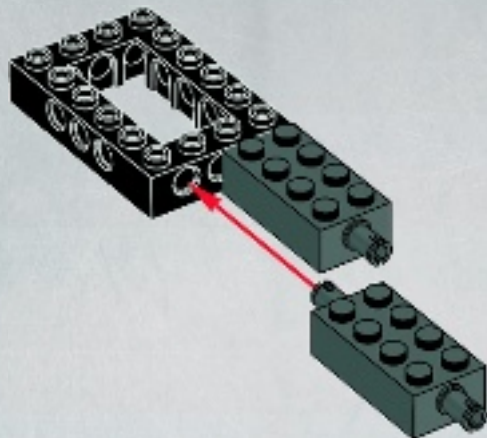

1x

2

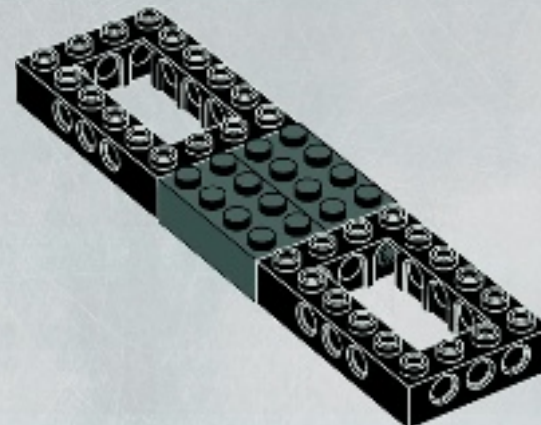



3

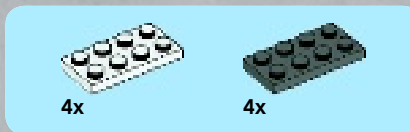
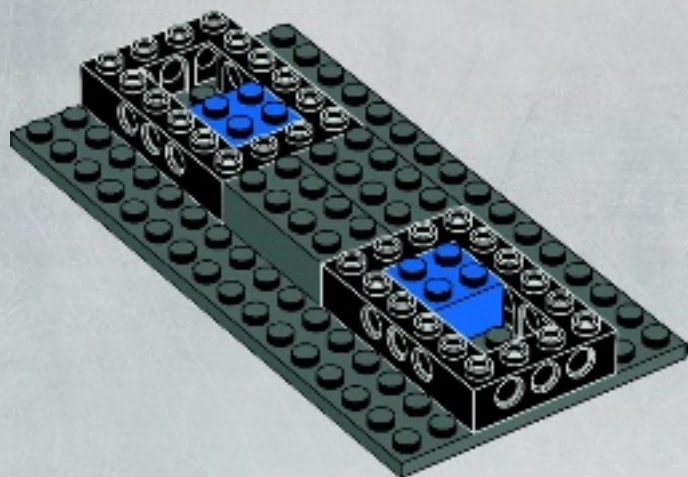

4

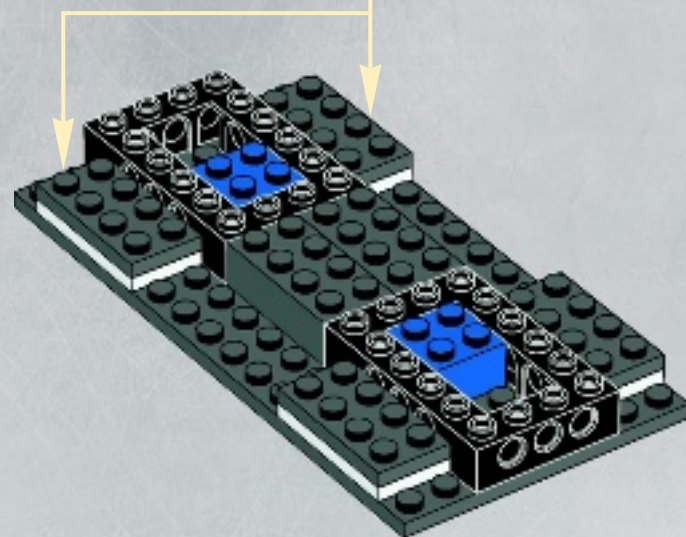
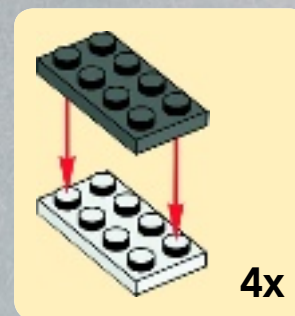



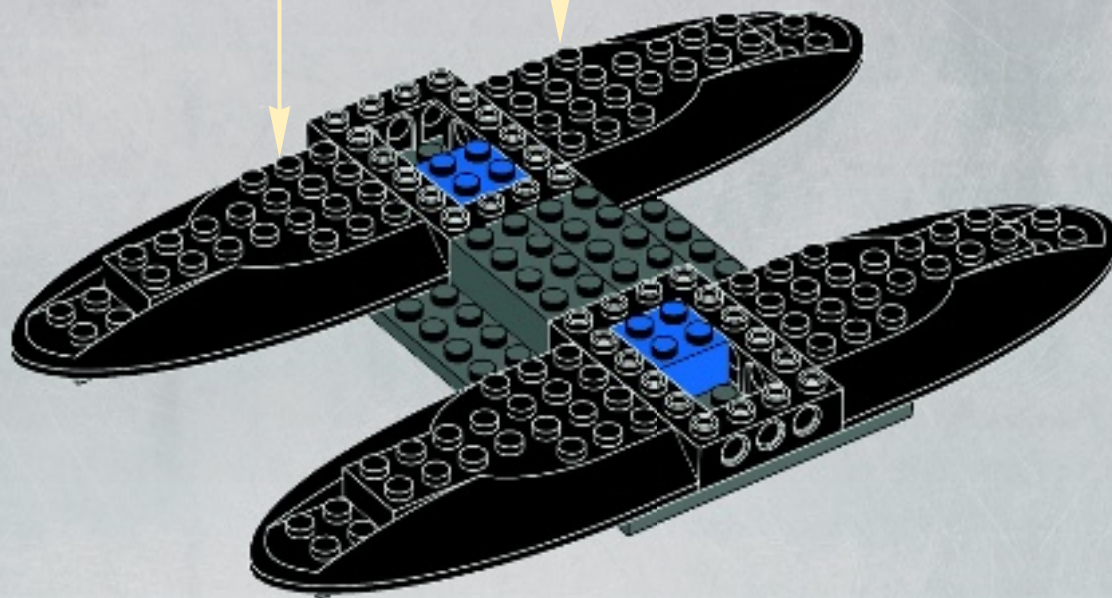
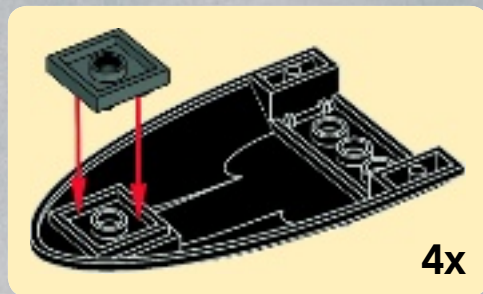

5



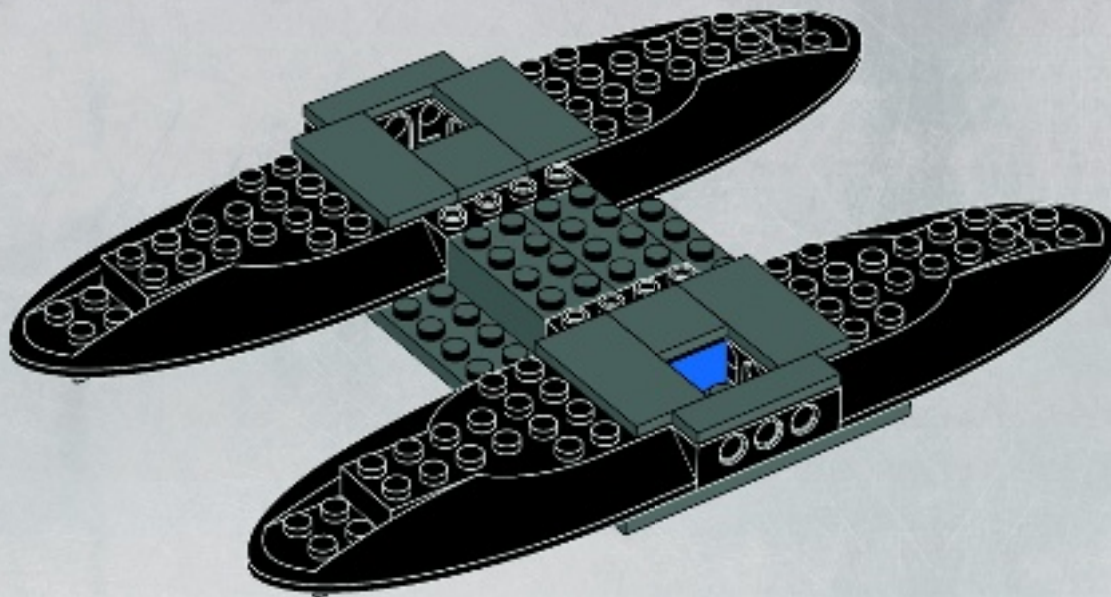

6



8x  1x 

7

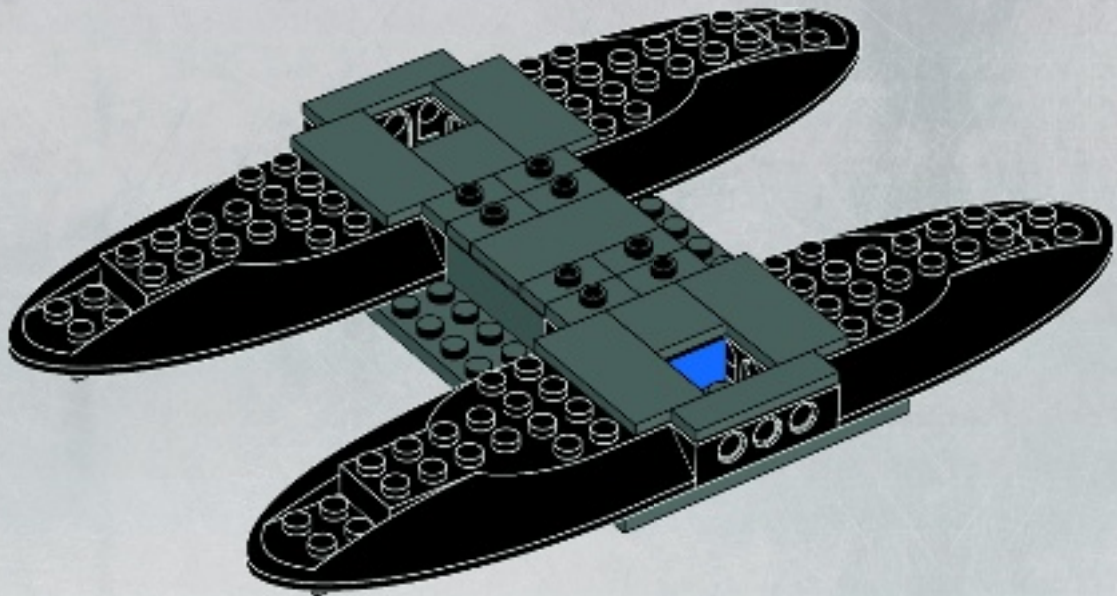



1

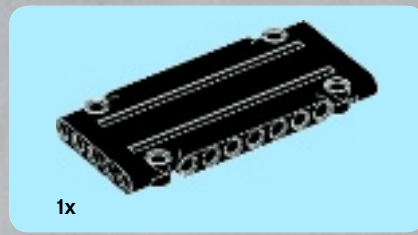

2

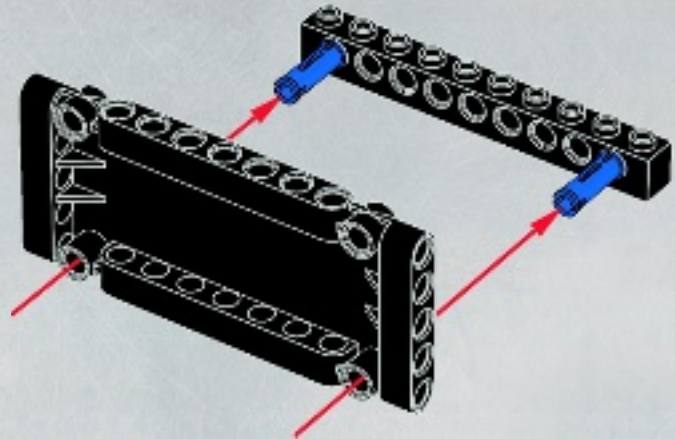

4x

3

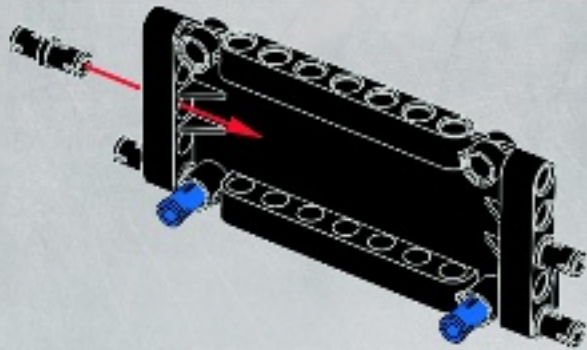

1x

4

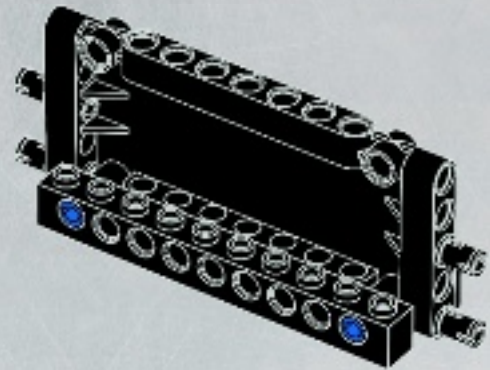

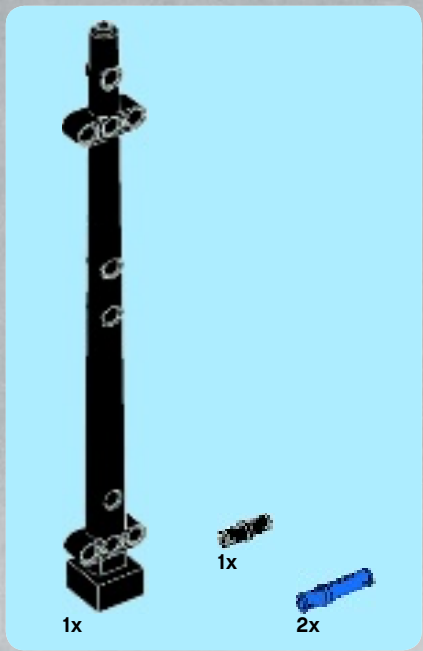

5

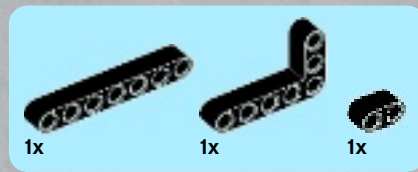

6



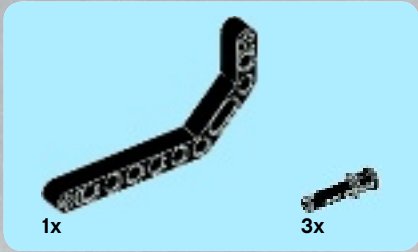

1

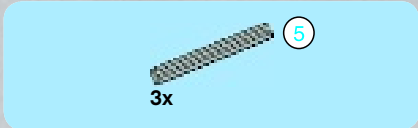
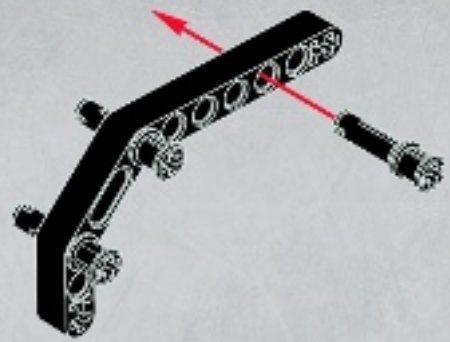

2

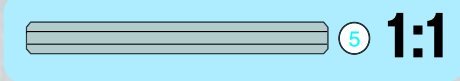
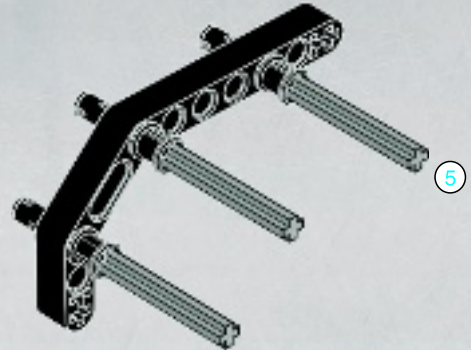

1:1



3

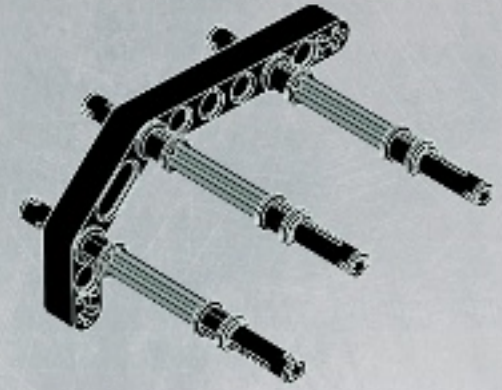

4

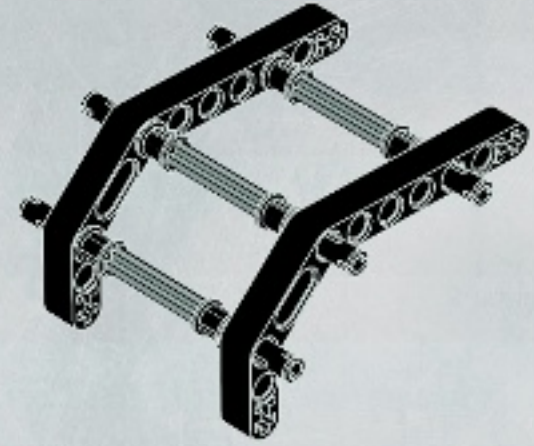



5

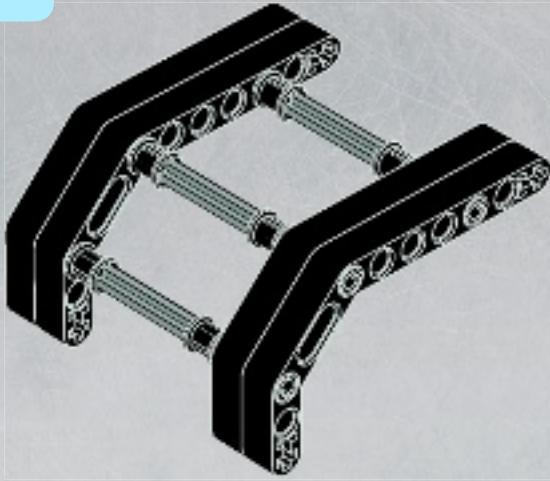

6

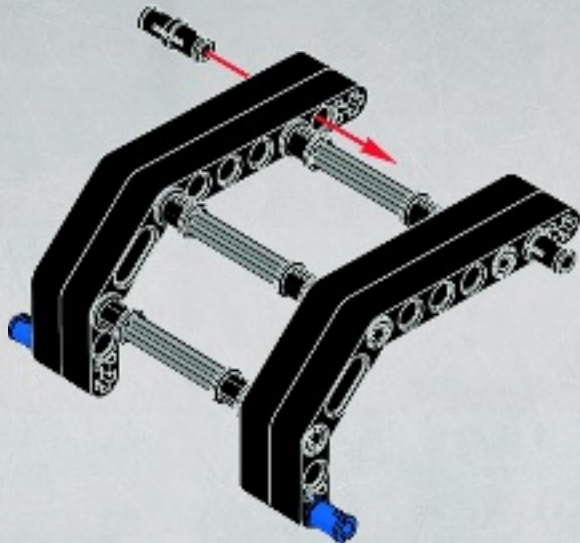

7

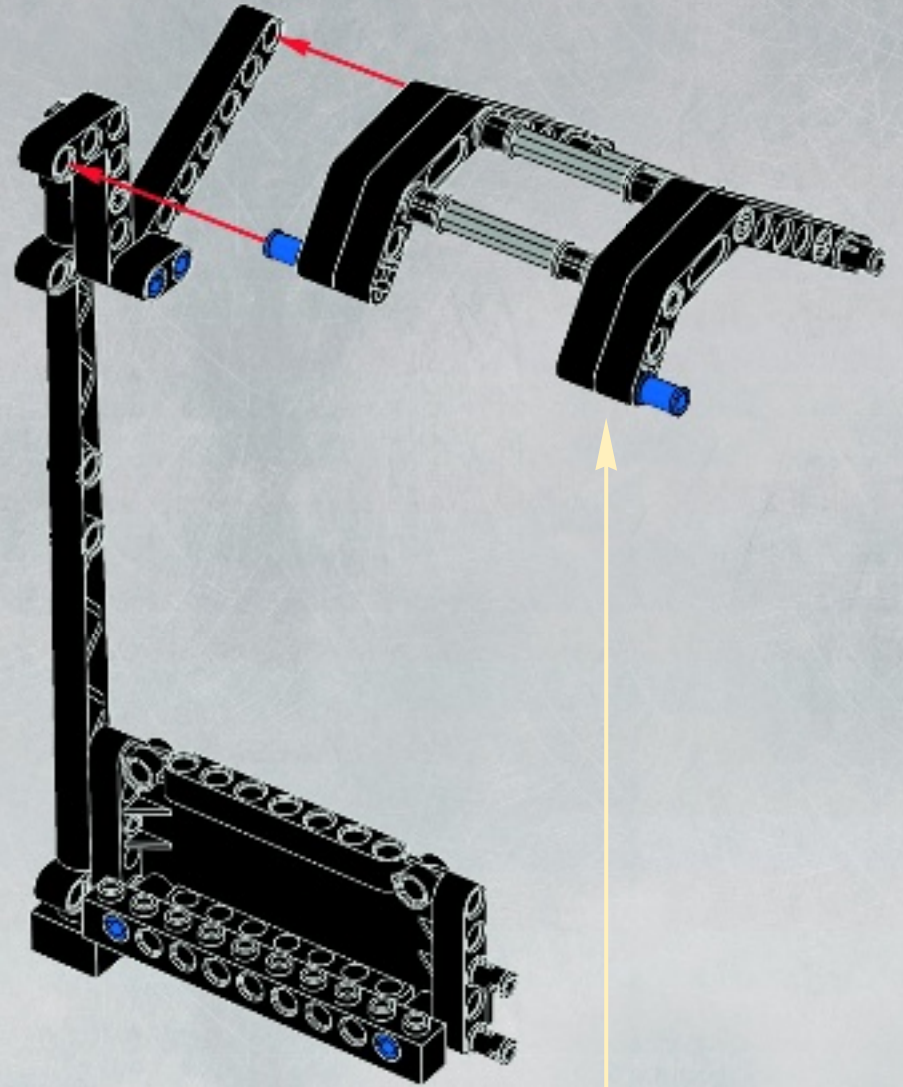

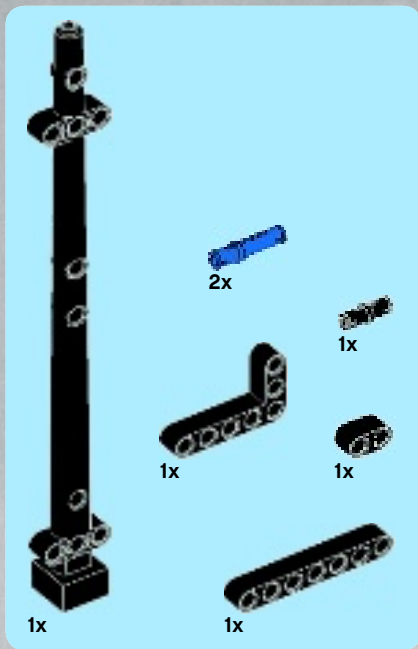

8

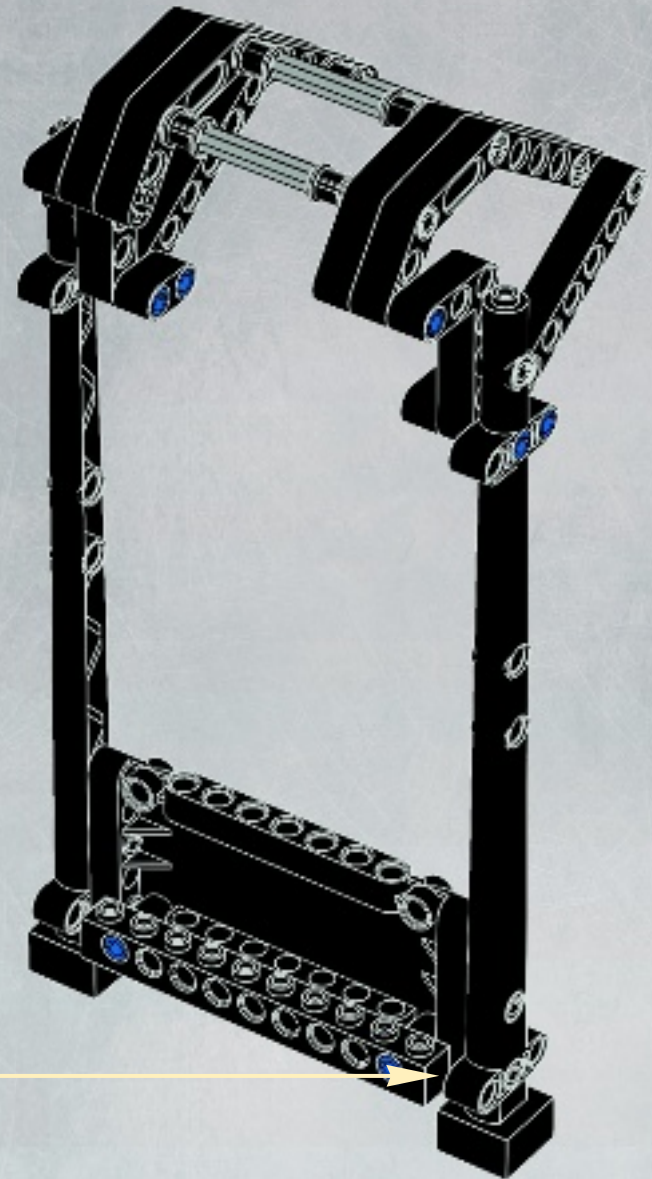
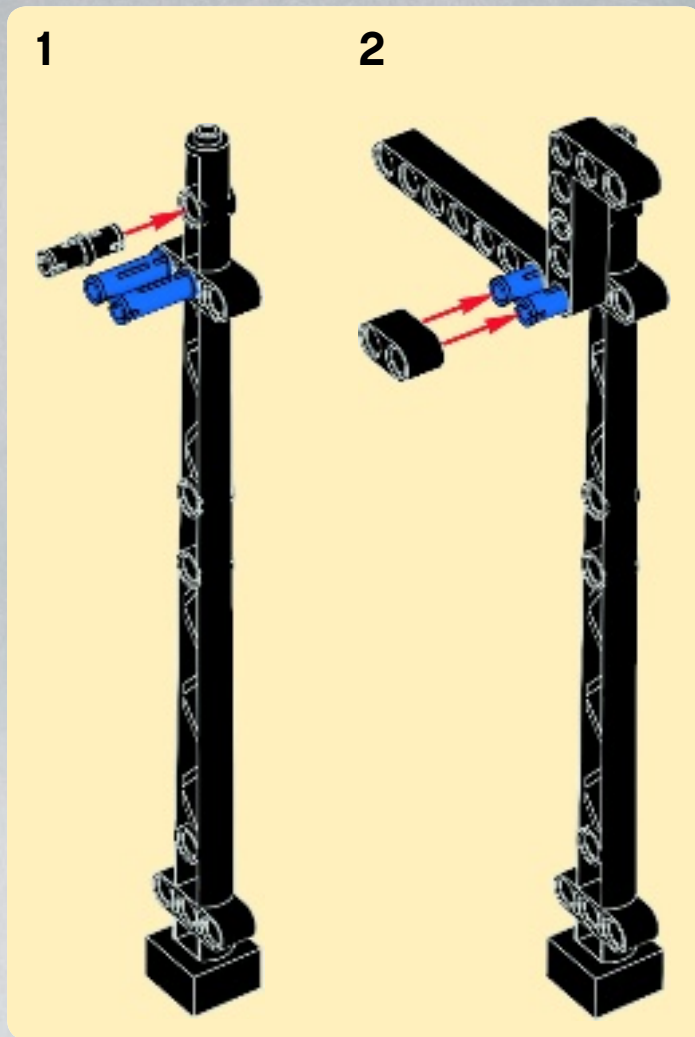

9

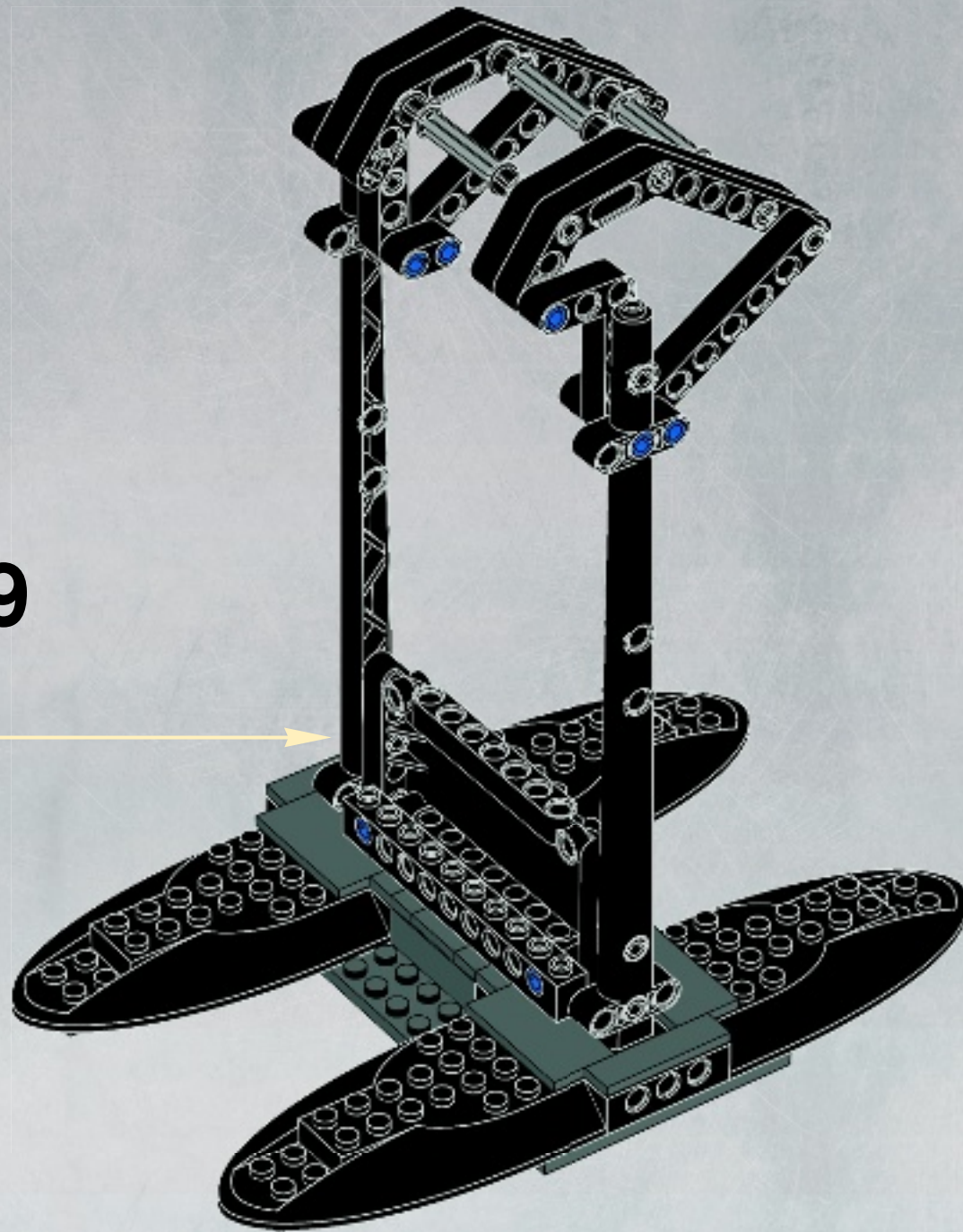



2x



2x



2x

10

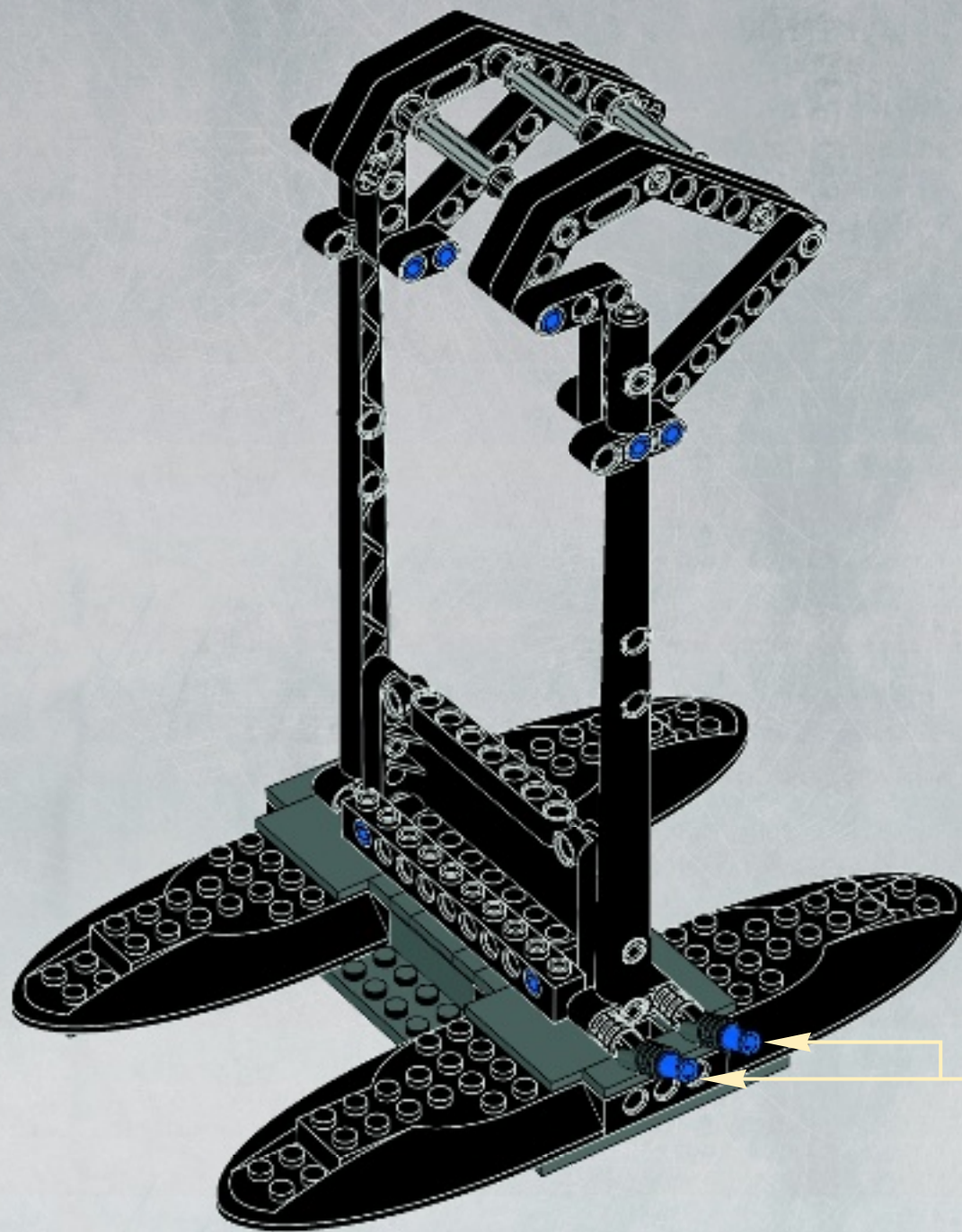

1



2



2x

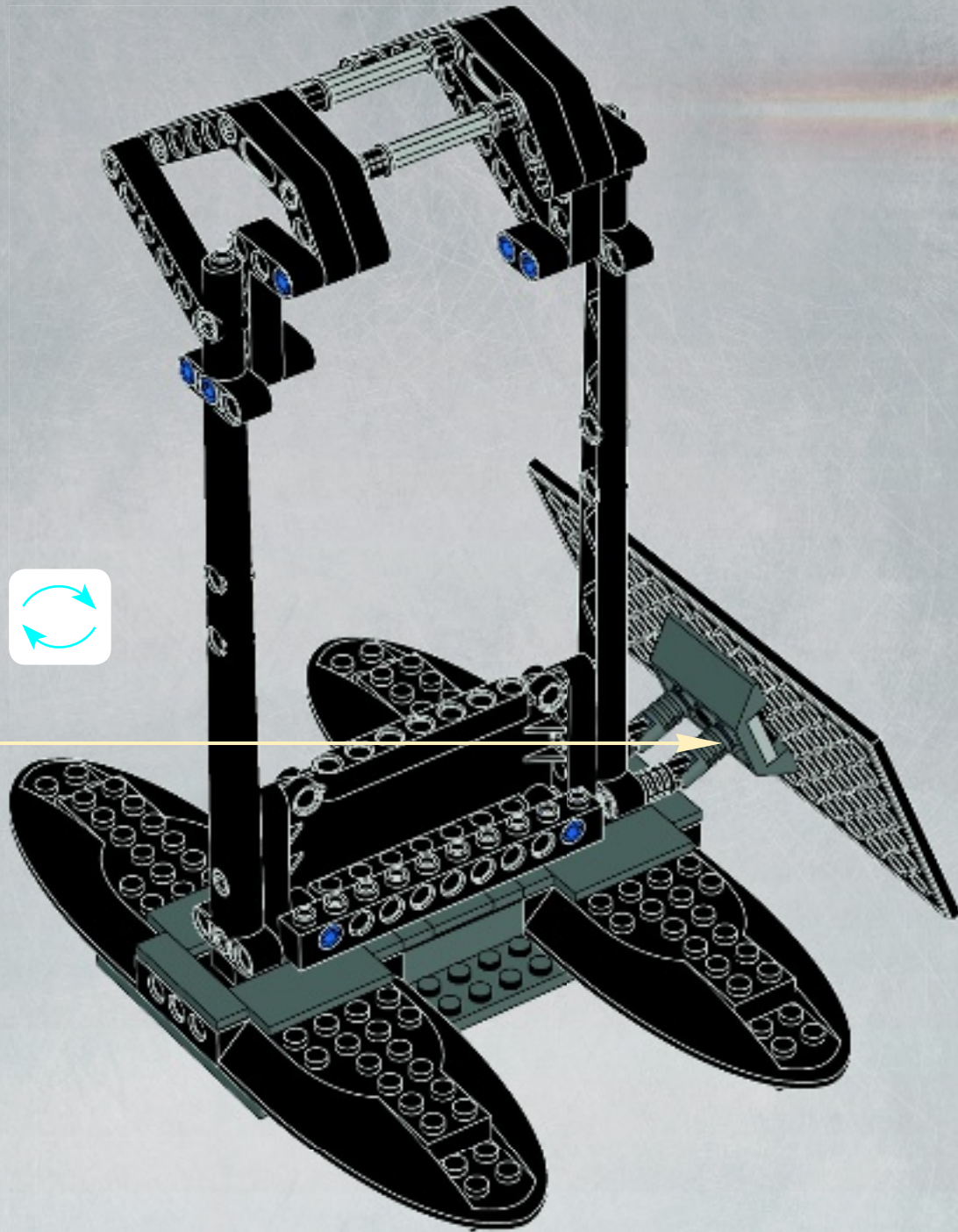

12

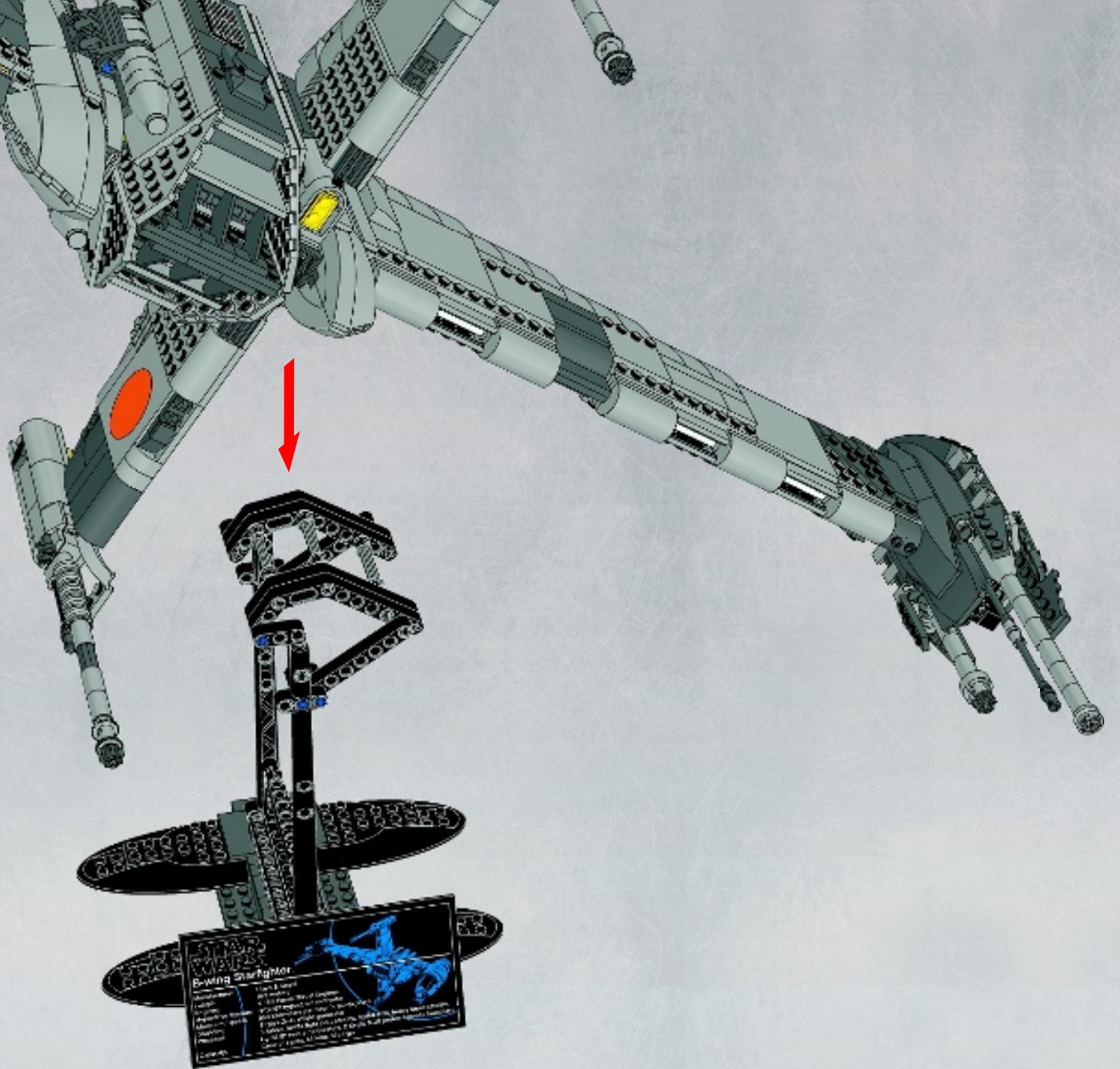



- 2x 4181142
- 9x 302001
- 6x 303201
- 2x 4293876
- 4x 4527947
- 5x 4113916
- 8x 4185273
- 12x 4125220
- 40x 4113917
- 3x 4118790
- 10x 4124067
- 3x 4114026
- 5x 4278422
- 2x 300221
- 6x 300421
- 13x 302221
- 19x 379521
- 8x 303221
- 8x 4226876
- 4x 300323
- 2x 379423
- 16x 362323
- 2x 383223
- 12x 373823
- 2x 4195007
- 8x 4206482
- 15x 4514553
- 4x 4243817
- 6x 303524

- 4x 244424
- 1x 4239601
- 8x 300226
- 6x 4558954
- 2x 407026
- 1x 4253815
- 4x 4162443
- 1x 4526931
- 4x 370226
- 2x 4144025
- 2x 273026
- 1x 4121966
- 4x 242026
- 2x 371026

- 4x 366626
- 8x 6030718
- 1x 415026
- 8x 241226
- 12x 4144575
- 8x 4556158
- 8x 4535739
- 2x 4613759
- 2x 4558170
- 1x 317626
- 2x 303026
- 2x 303326
- 2x 302726

- 4x 4653049
- 1x 403226
- 3x 241926
- 6x 4140303
- 2x 4538722
- 1x 4161403
- 1x 6018805
- 4x 4295395
- 4x 4623524
- 1x 4566243
- 1x 4603646

- 2x 4263506
- 2x 4141580
- 2x 4159335
- 4x 4205760
- 1x 4177444
- 1x 4552347
- 2x 4142823
- 1x 4142135
- 2x 4495935
- 4x 4111998

- 2x 4612482
- 38x 4121715
- 6x 4140801
- 4x 370526
- 2x 370726
- 4x 370826
- 8x 4233489
- 9x 302128
- 11x 371028
- 2x 4194746
- 2x 4194535
- 8x 3006347
- 2x 4654448
- 1x 6013130

- 2x 4211060
- 2x 4210875
- 6x 4211128
- 2x 4497253
- 2x 4210718
- 1x 4296788
- 7x 4504378
- 2x 4621917
- 1x 4226221
- 7x 4567887
- 4x 4211000
- 2x 4218188
- 2x 4211127
- 1x 4210848
- 4x 6030710
- 2x 4579354
- 2x 4620079
- 1x 4210892
- 1x 4221879
- 5x 4210763
- 10x 4211052
- 2x 4210631
- 5x 4277928
- 7x 6000606
- 2x 4211055
- 7x 4210884

- 1x 4294180
- 1x 4658974
- 1x 4225873
- 4x 4210797
- 2x 4211093
- 8x 4246896
- 4x 6006939
- 4x 4556083
- 8x 4210968
- 8x 6005668
- 2x 4210779
- 2x 4210873
- 4x 4509911

- 1x 4180486
- 7x 4211094
- 4x 4211043
- 31x 4211065
- 3x 4211002
- 2x 4211001
- 4x 4211056
- 4x 4210998
- 10x 4211134
- 2x 4211061
- 2x 4210802
- 1x 4654613

- 1x 4217558
- 2x 4622569
- 6x 4211053
- 2x 4611708
- 13x 4560184
- 6x 4210651
- 2x 4211008
- 1x 4210872
- 2x 4210788
- 2x 4210782
- 1x 4290149
- 1x 4290150
- 1x 4210865









- 2x 4210728
- 4x 4222042
- 1x 4211039
- 5x 4538721
- 2x 4211051
- 2x 4502068
- 1x 4210940
- 2x 6007024
- 6x 4582820
- 10x 4540386
- 10x 4218696
- 8x 4211119
- 1x 6005670
- 2x 4652483



- 2x 4210695
- 8x 4210719
- 2x 4211066
- 2x 4210655
- 4x 4210759
- 4x 4211050
- 2x 4516546
- 4x 4210665
- 5x 4560177
- 1x 4499858
- 3x 4514559
- 1x 6007027
- 2x 4538126
- 2x 4566927
- 2x 4211180
- 20x 4216581



Customer Service
Kundenservice
Service Consommateurs
Servicio Al Consumidor

www.lego.com/service or dial

00800 5346 5555 :        

1-800-422-5346 :  



www.LEGOclub.com



LEGO® Club Email



LEGO® Club Magazine

LEGO club™

FREE! GRATIS! GRATUIT!

SIGN UP ONLINE!

www.LEGOclub.com

VISIT THE WORLD'S
BIGGEST LEGO® SHOP!
www.LEGOshop.com

GO TO
www.LEGOclub.com

00800 5346 5555*

1-866-534-6258 • 1-877-518-5346

US & Canada only

Canada seulement



- * Freephone. Mobile charges may apply.
- * Numéro sans frais. Des frais peuvent s'appliquer avec les téléphones cellulaires.
- * Gebührenfrei, Kosten für Anrufe aus Mobilfunknetzen können abweichen.
- * Gratis telefoonnummer vanaf vaste lijn.
- * Det er et gratis nummer, når du ringer fra fasttelefon.
- * Det är gratis, när du ringer från en fast telefon.
- * Numéro sans frais. Des frais peuvent s'appliquer avec les téléphones portables.



WIN!

Go to www.LEGOsurvey.com/product to fill out a survey for a chance to win a cool LEGO® Product. No purchase necessary. Open to all residents where not prohibited.



www.LEGOsurvey.com/product

GEWINNE!

Nimm an der Umfrage auf www.LEGOsurvey.com/product teil und hab die Chance ein cooles LEGO® Produkt zu gewinnen! Die Teilnahme am Gewinnspiel führt zu keinerlei Kaufverpflichtungen. Teilnahme in allen nicht ausgeschlossenen Ländern möglich.

WIN!

Ga naar www.LEGOsurvey.com/product, vul een enquêteformulier in en maak kans op een cool LEGO® product. Geen aankoopverplichting. Iedereen mag deelnemen, uitgezonderd ingezetenden van landen waar een enquêteverbod geldt.

GAGNE!

Visite www.LEGOsurvey.com/product pour répondre à un questionnaire et avoir une chance de gagner un produit LEGO® très cool ! Aucune obligation d'achat. Ouvert à tous les résidents des pays autorisés.

当てよう!

www.LEGOsurvey.com/product にアクセスして、アンケートにご記入ください。当選者にはレゴ製品を差し上げます。お買い上げの必要はありません。禁止されていない限り、すべての皆様にご利用いただけます。