

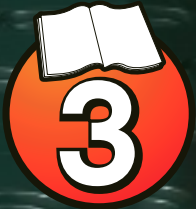

# TECHNIC

8070

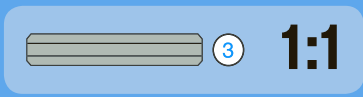



1



2

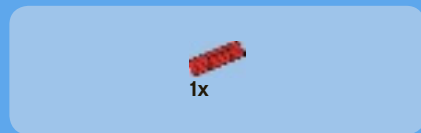

3



4



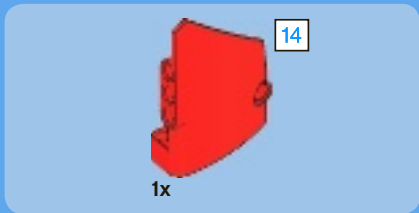

5

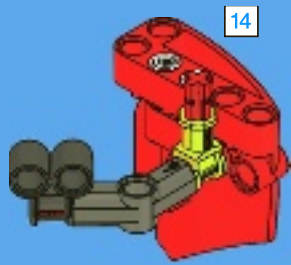

6

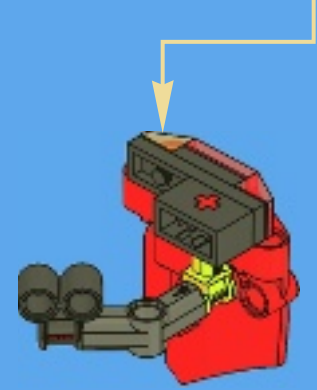

7

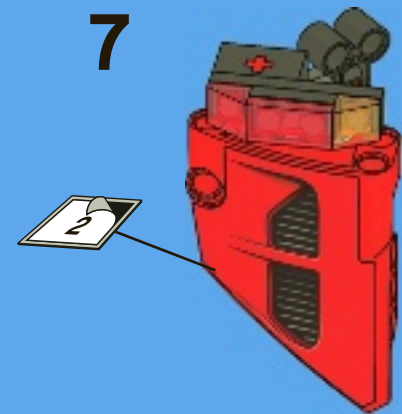



105

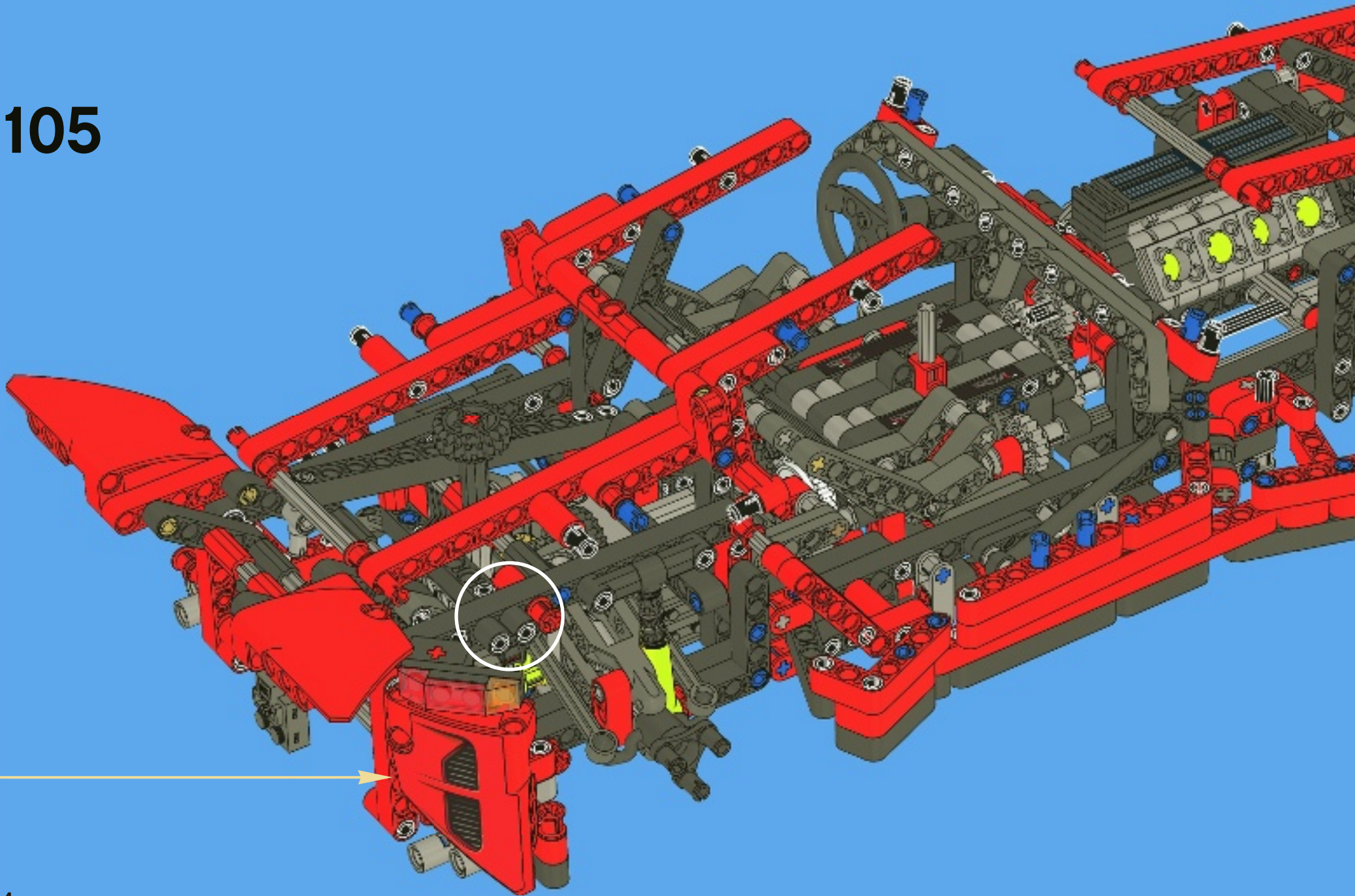



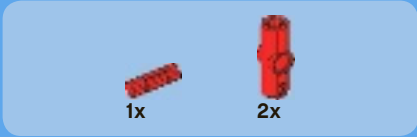
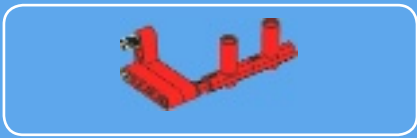

1

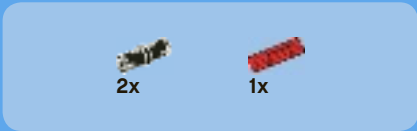
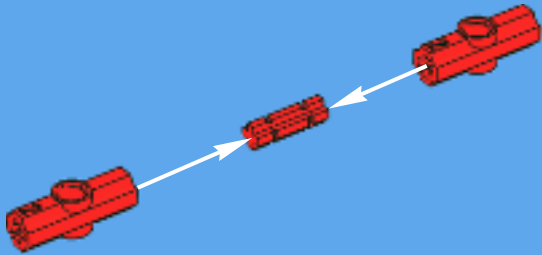

2

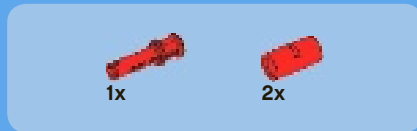
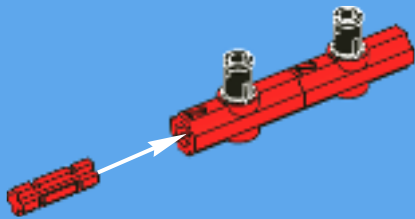

3

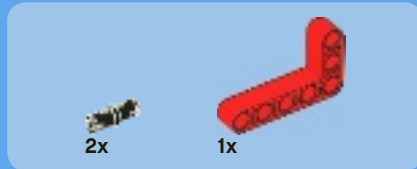
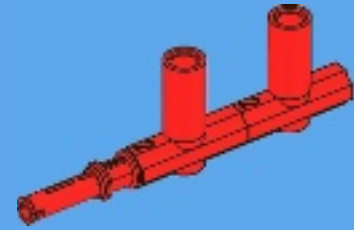

4

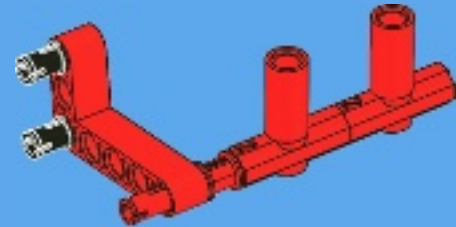

5

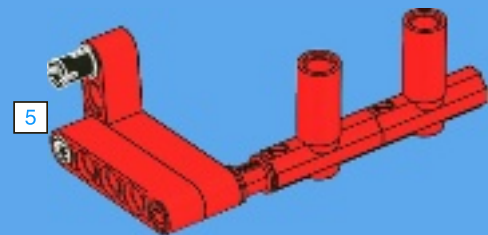



1x

# 106

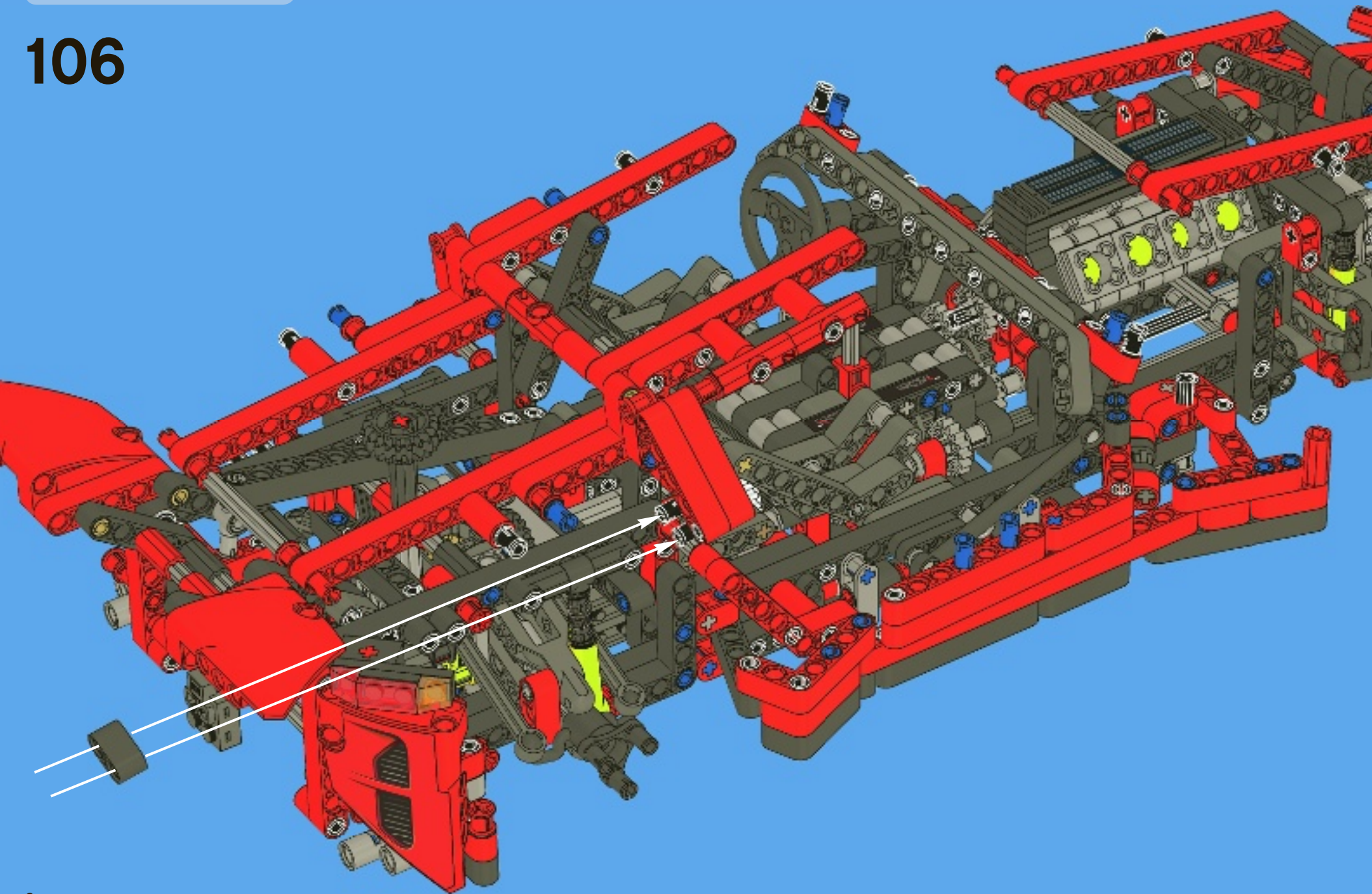





1

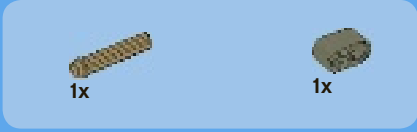
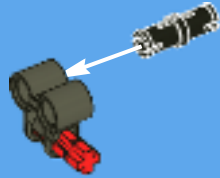

2

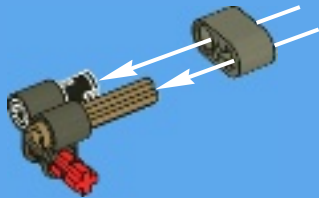

3

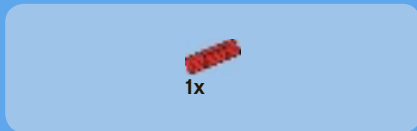
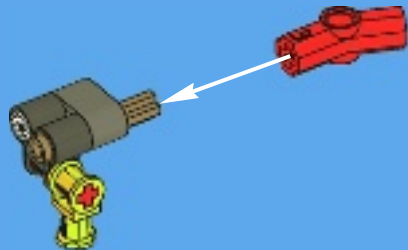

4

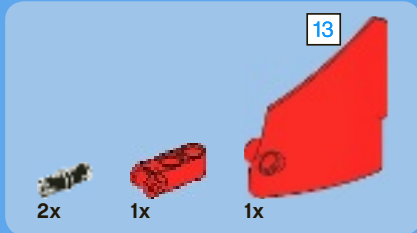

5

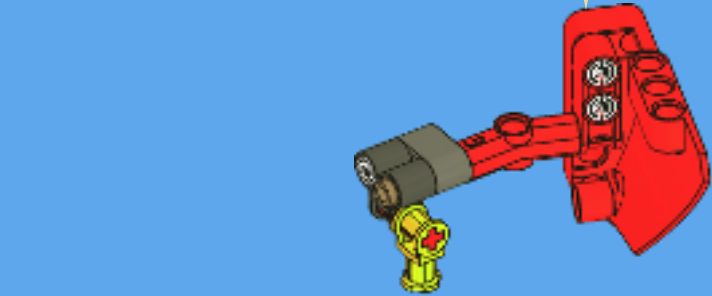
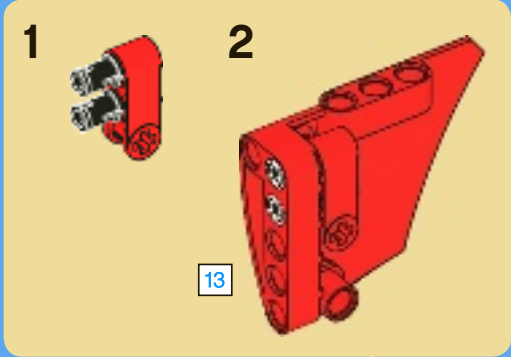

6

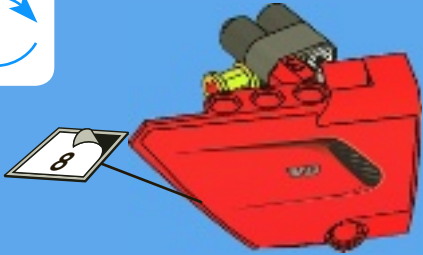

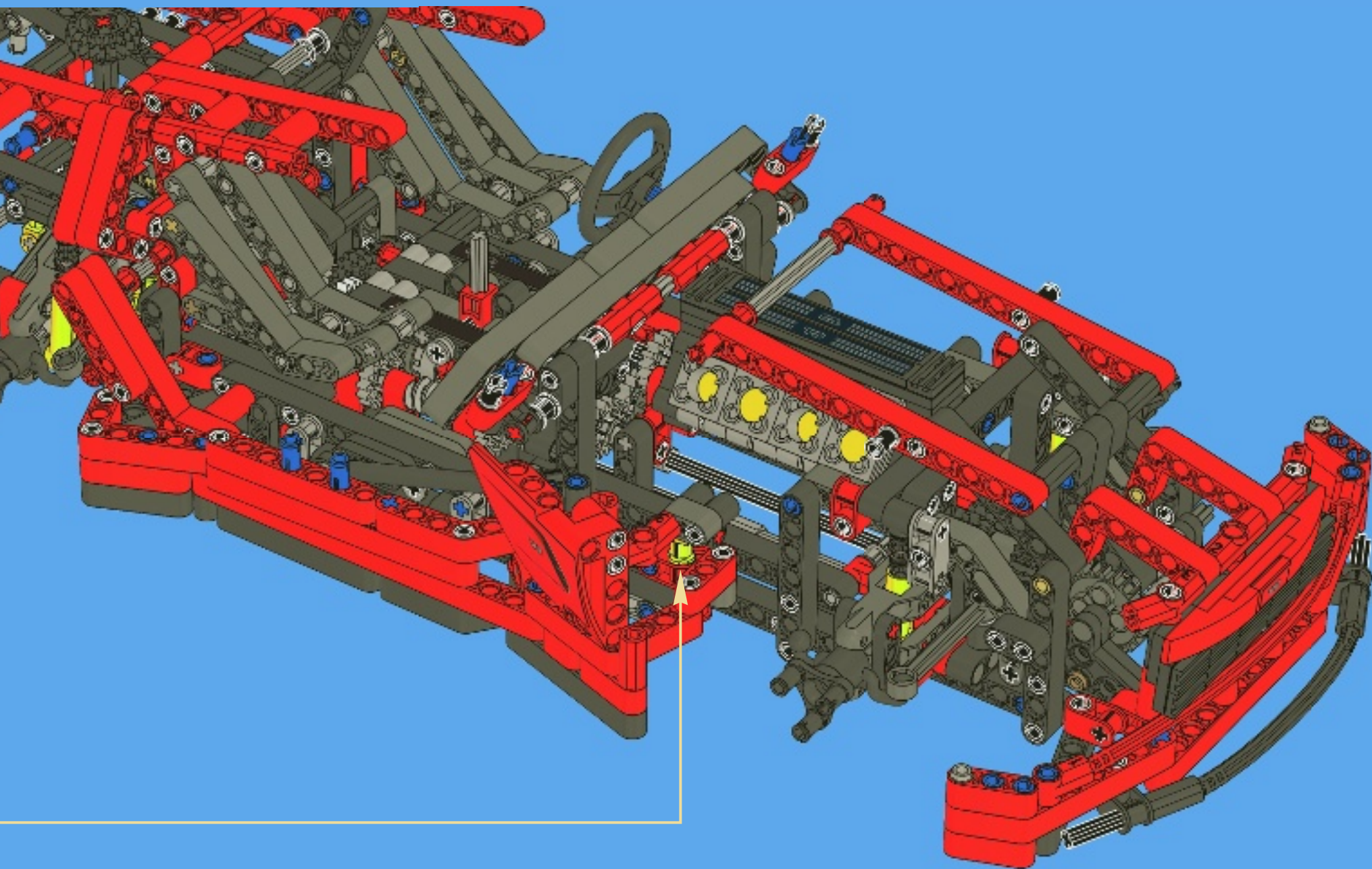



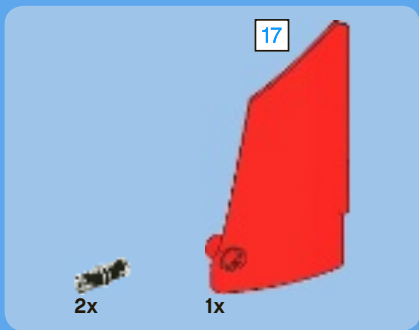

1

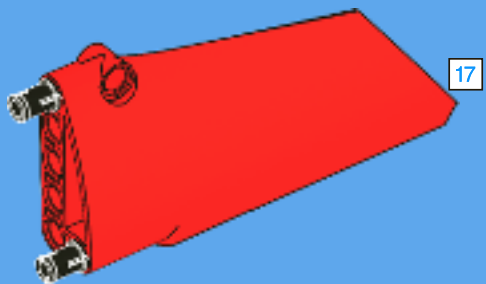

2

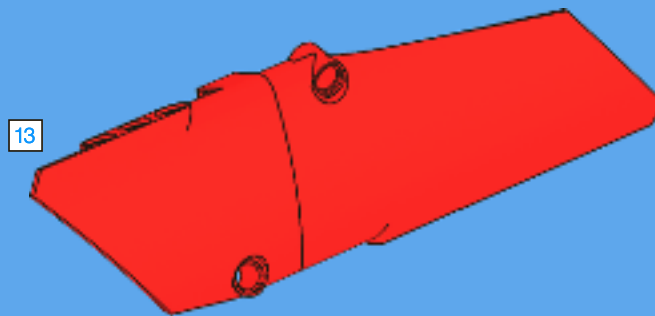

3

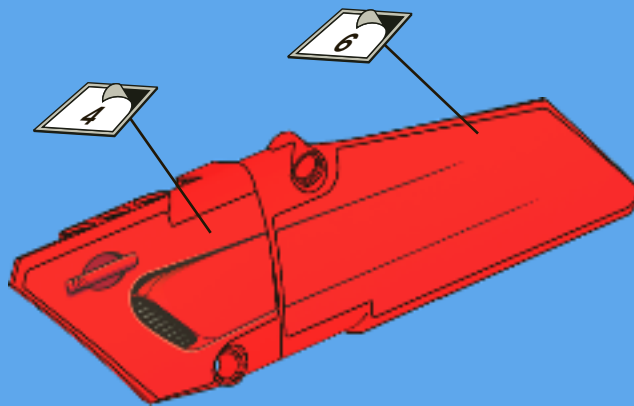

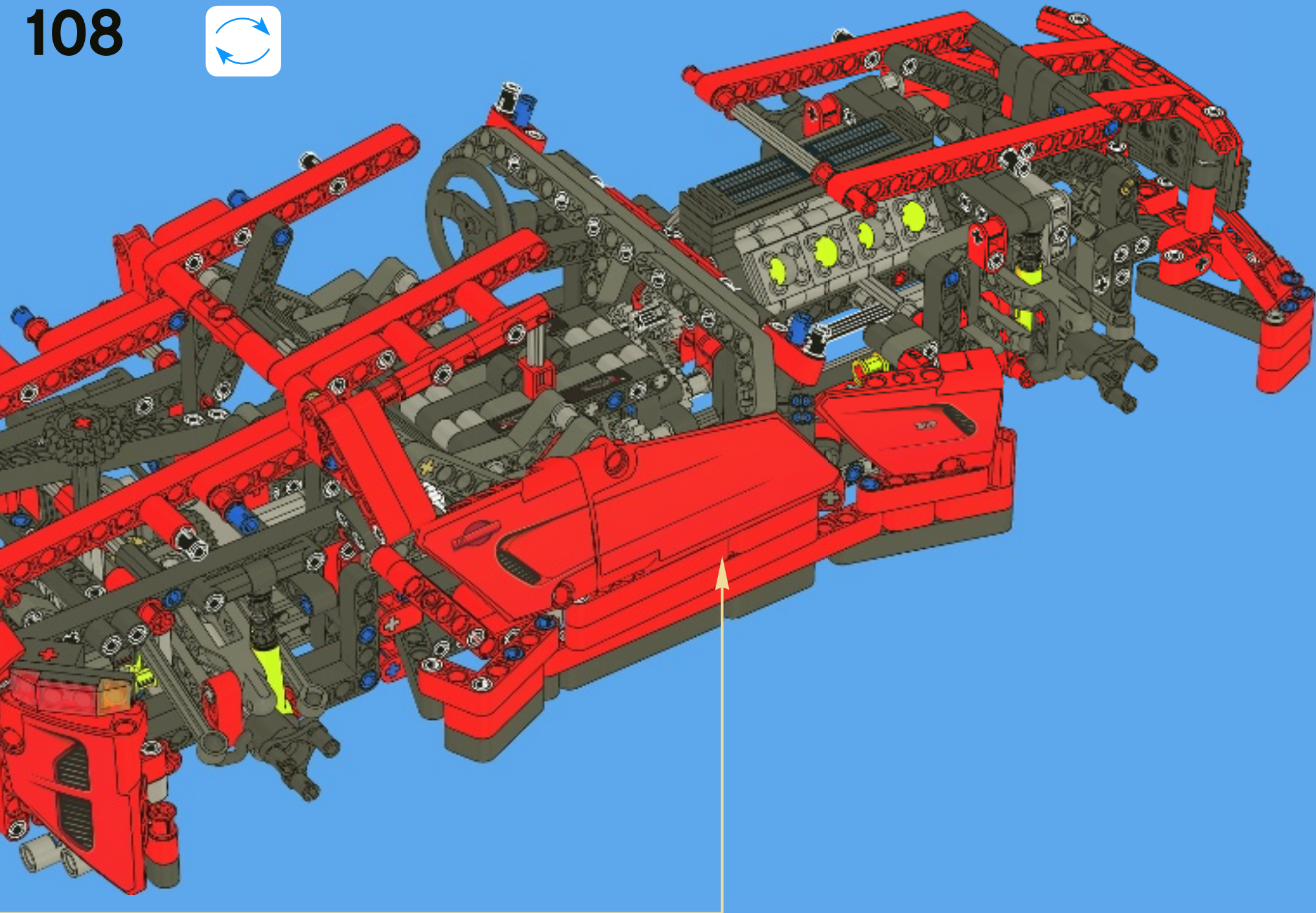



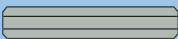

 ③ 1:1



1



2



3

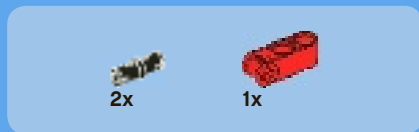

4

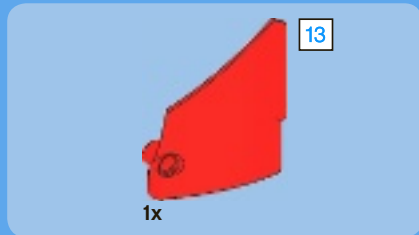

5

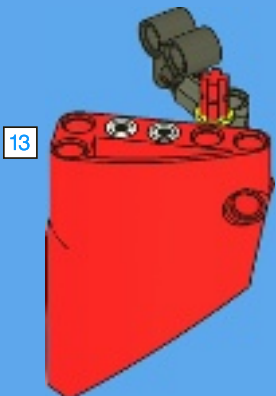



# 6

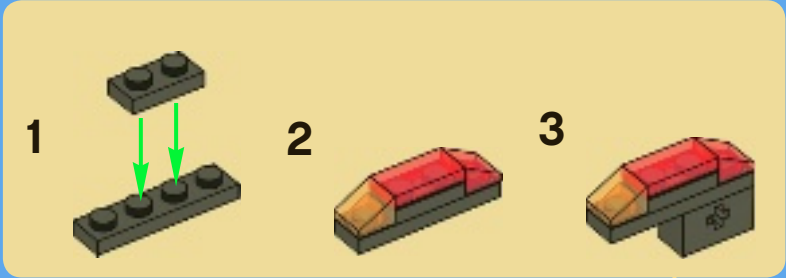

# 7

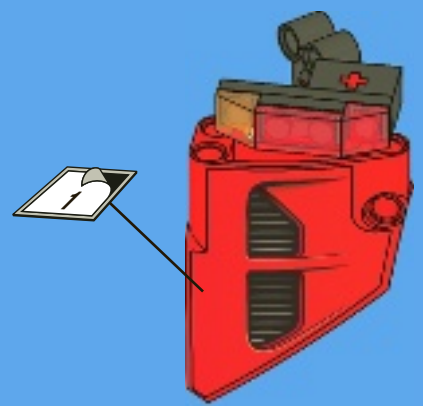



109

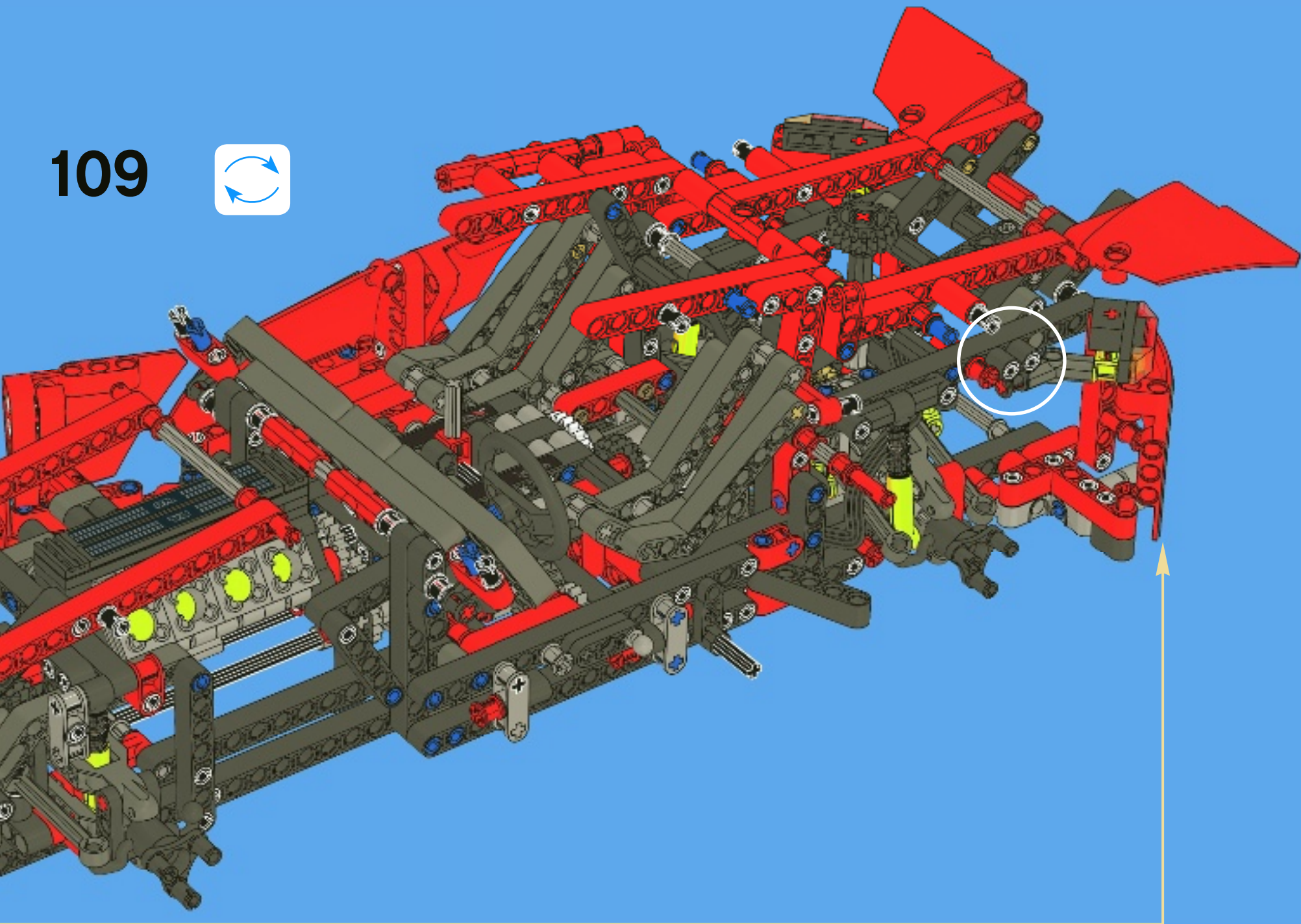



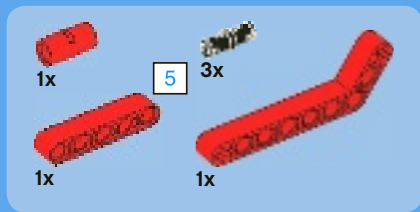

110

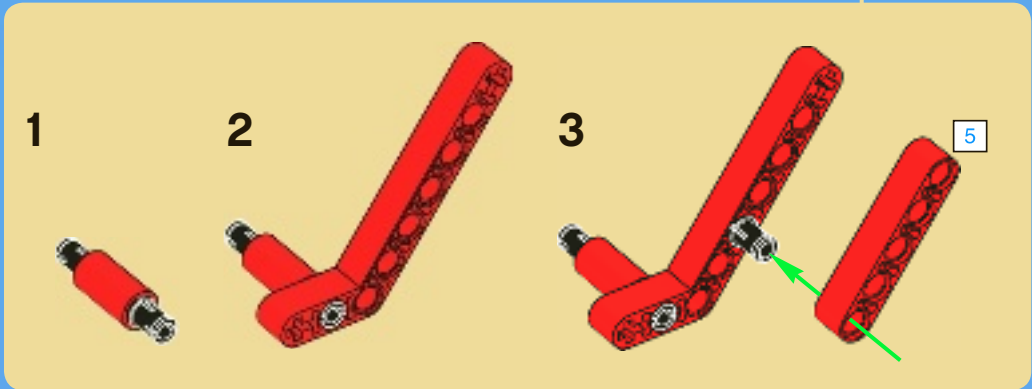
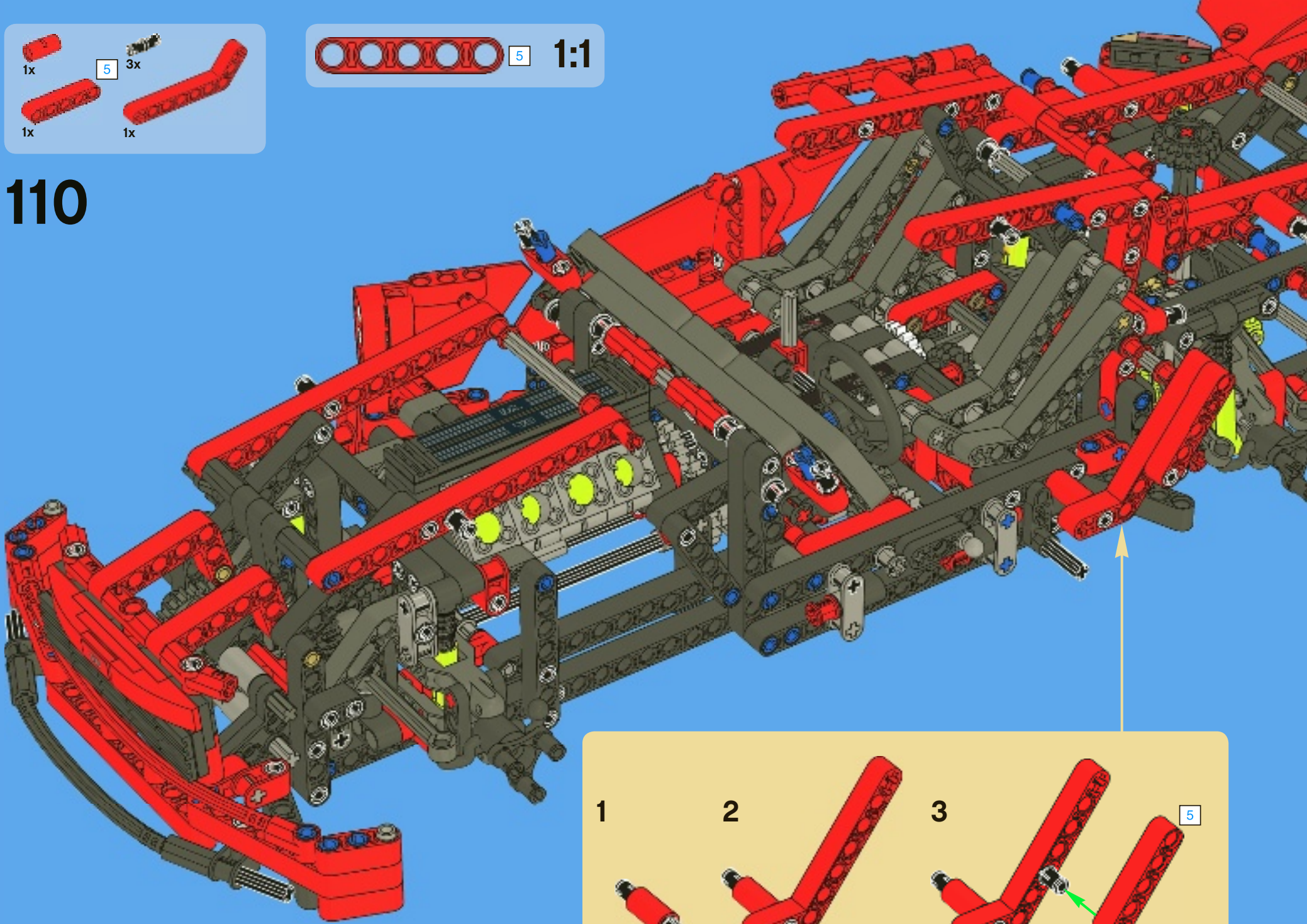



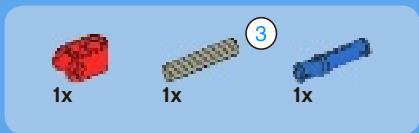
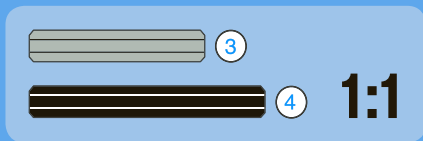
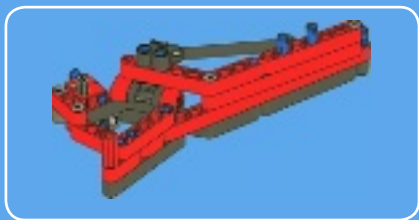

1

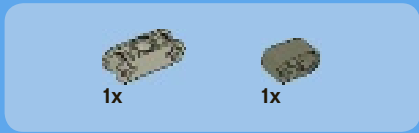
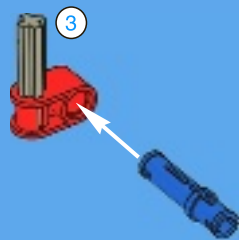

2

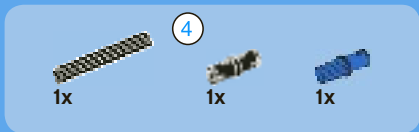

3

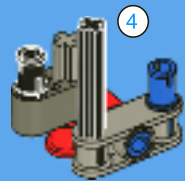

4

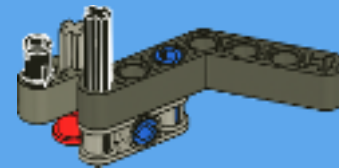

5

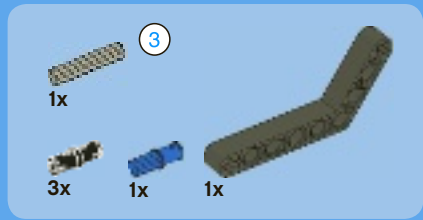
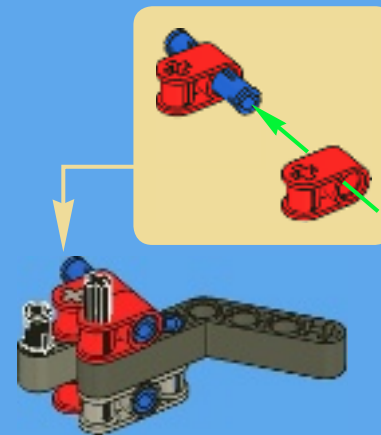

6

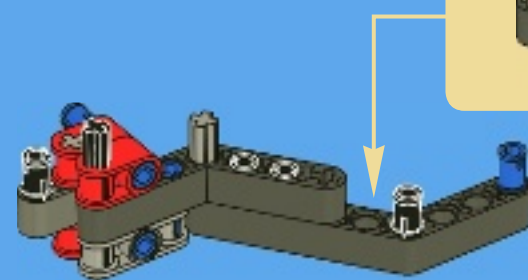
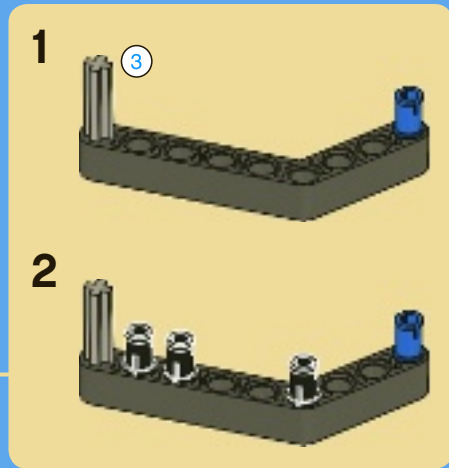

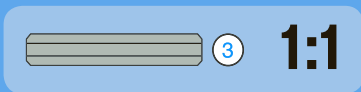
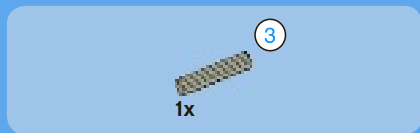

7

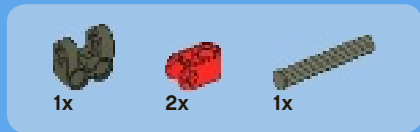
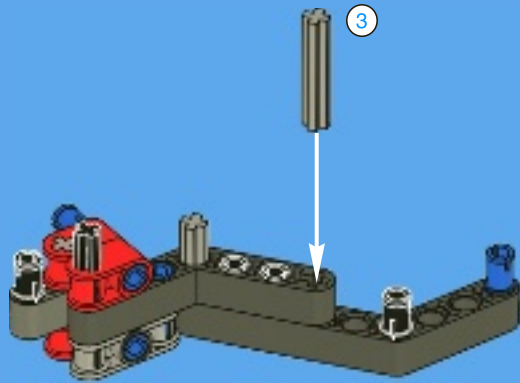

8

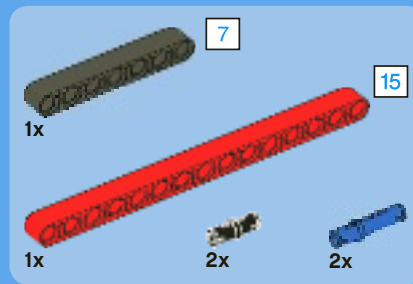
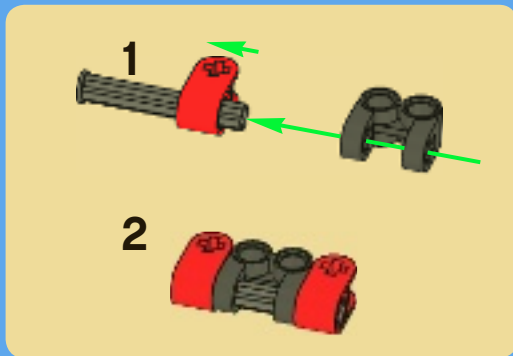

9

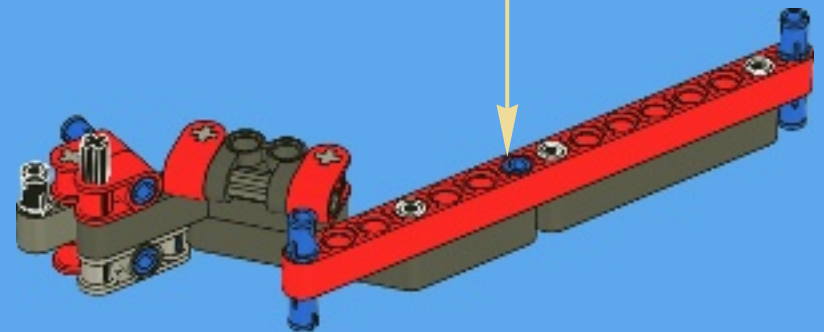
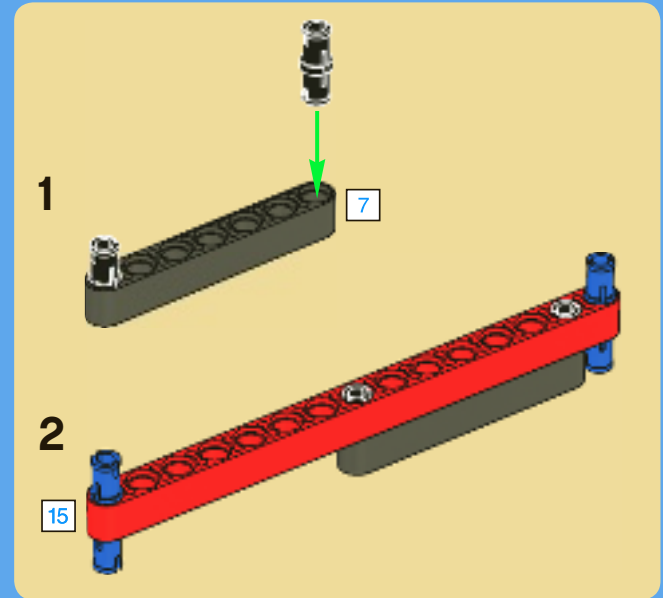



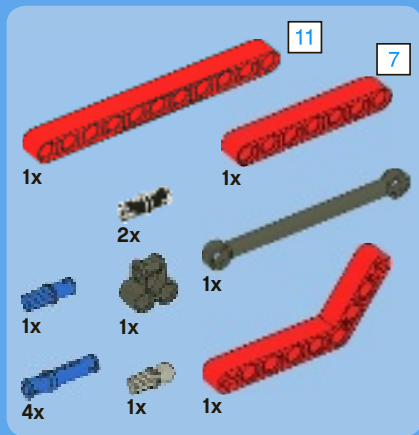

# 10

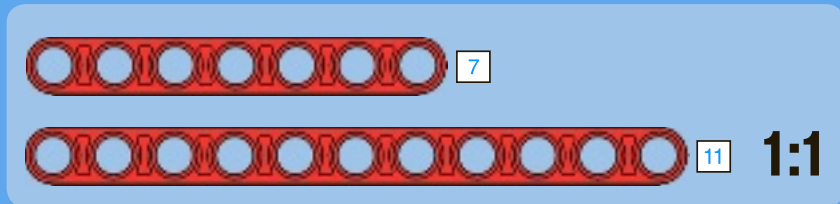
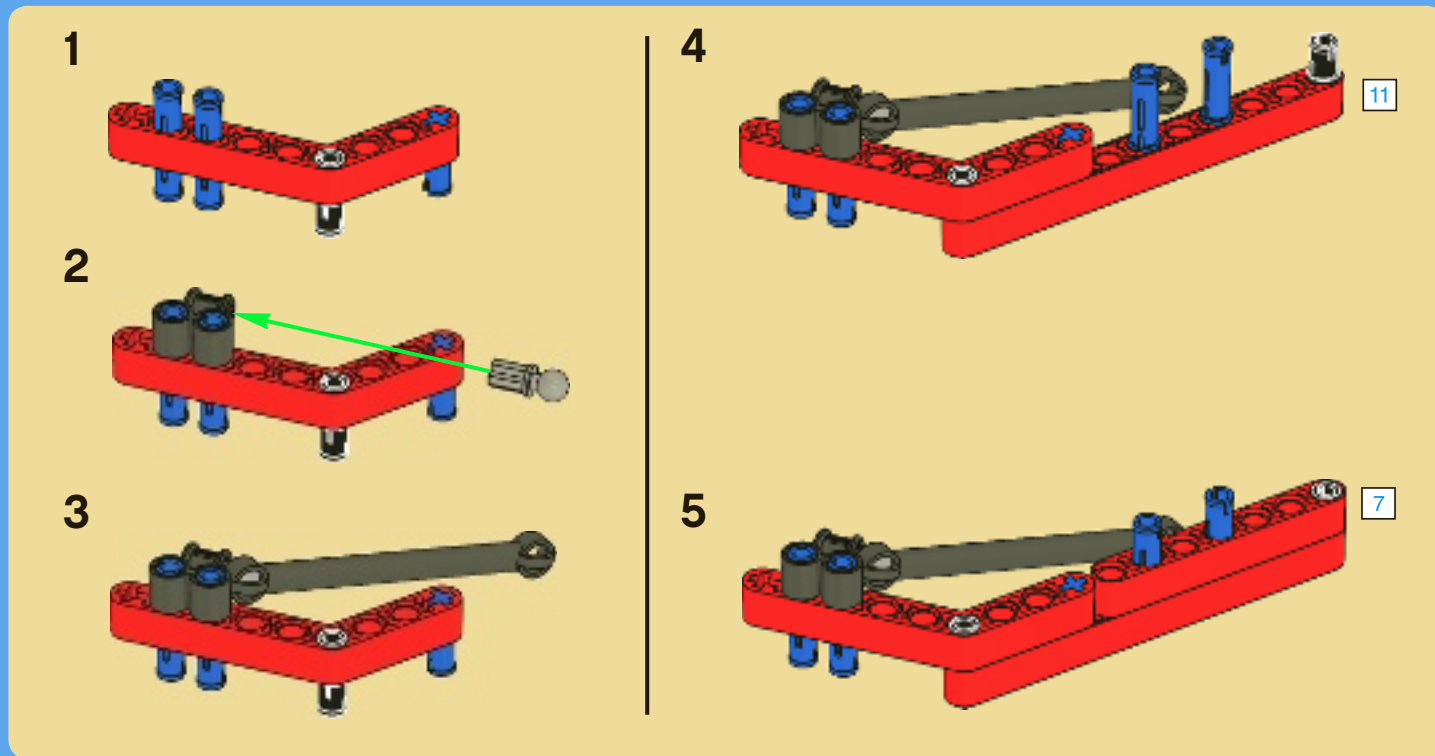

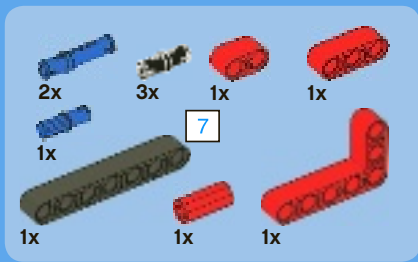

11

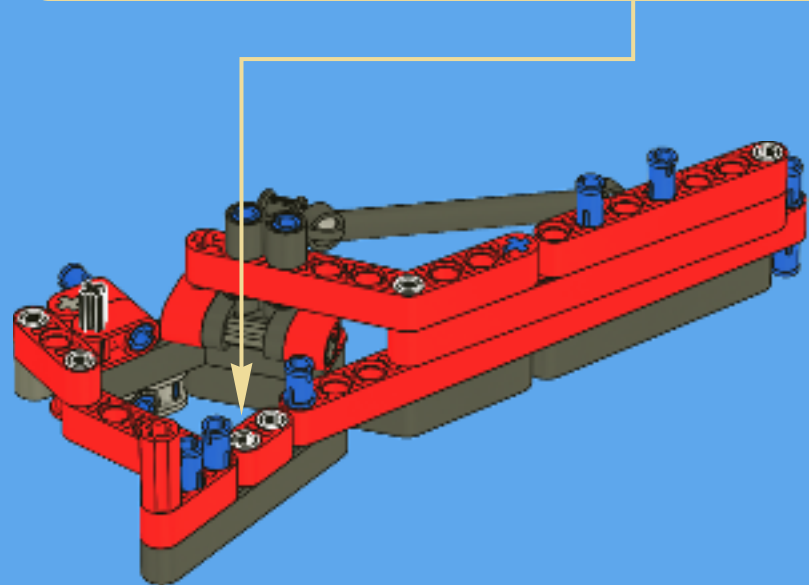
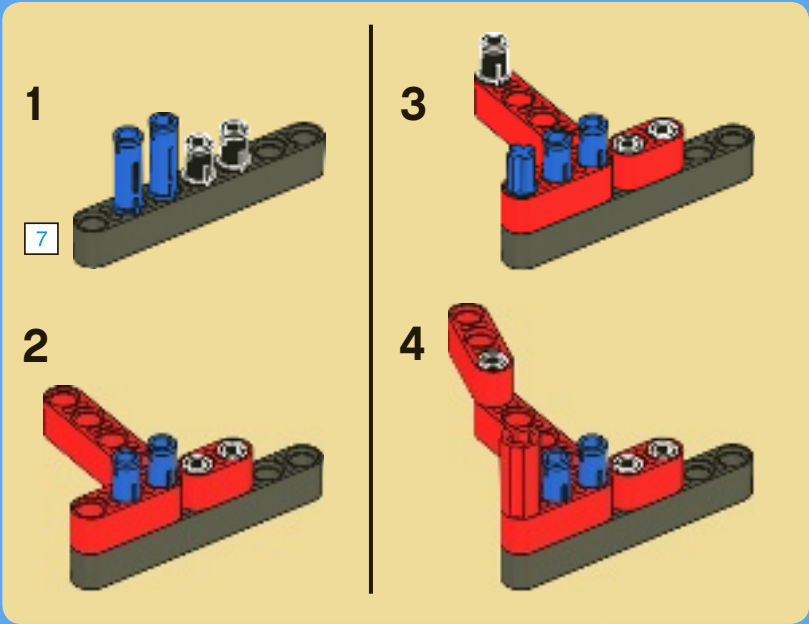



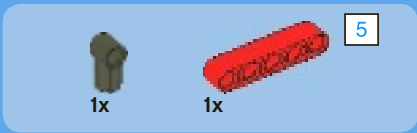

12

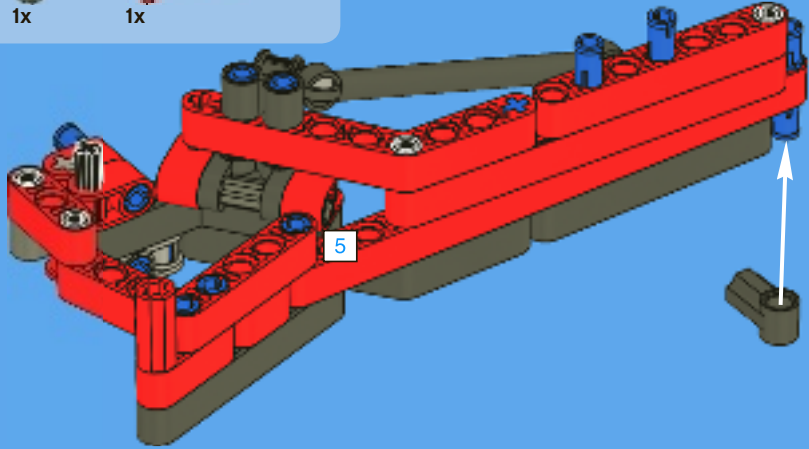

111

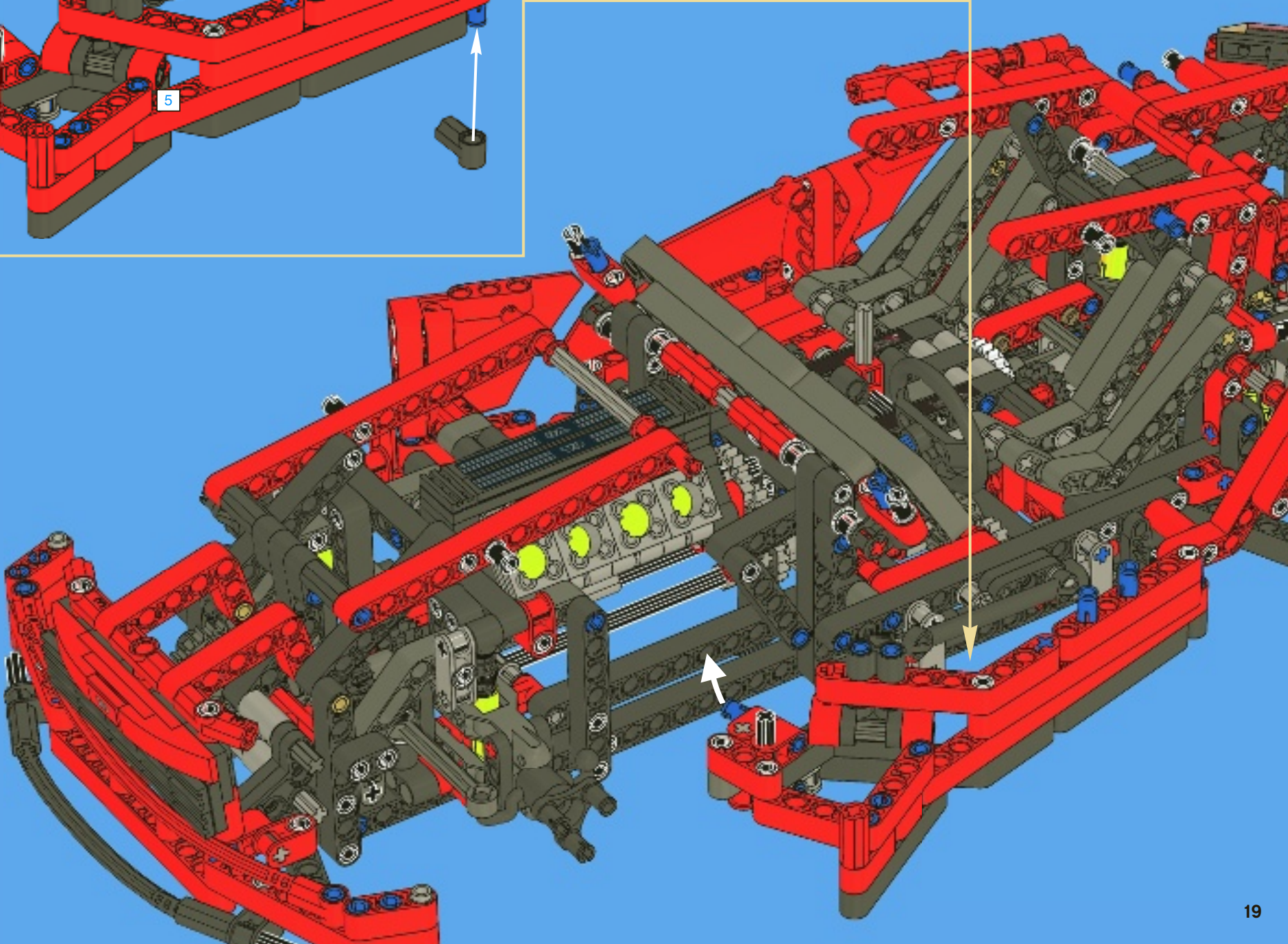



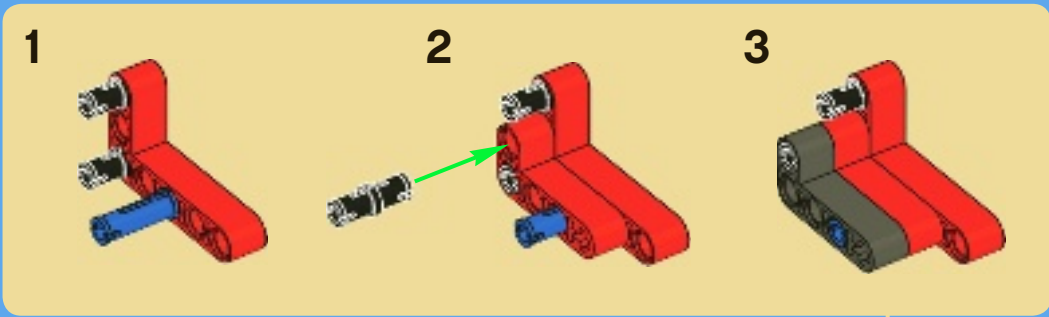
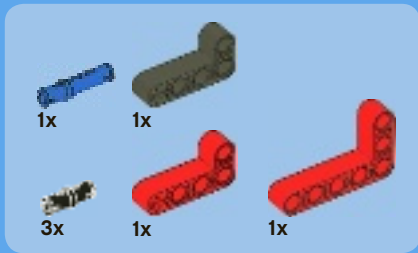

112

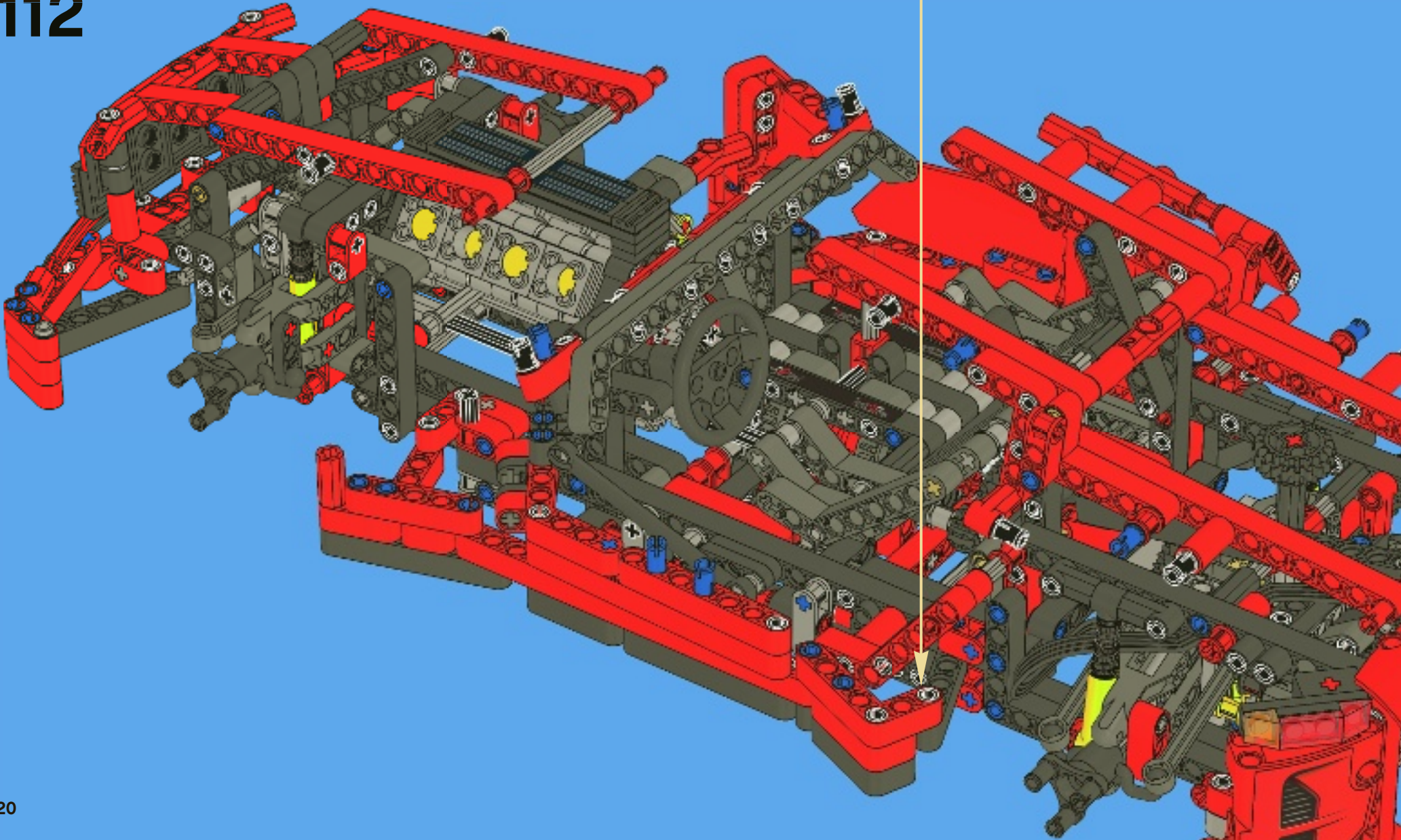

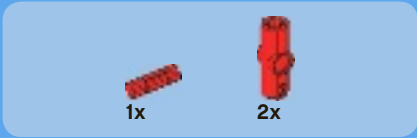
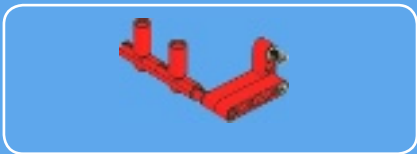

1

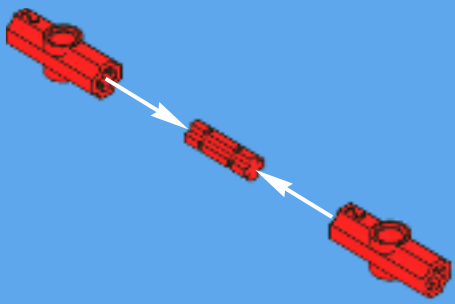

2



3

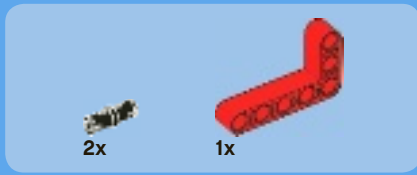
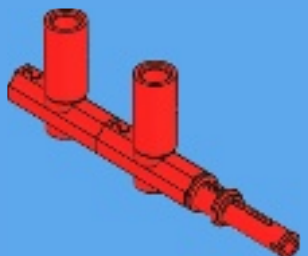

4

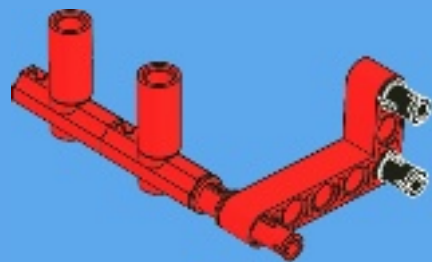

5

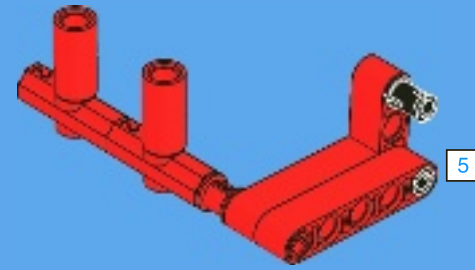





1x

# 113

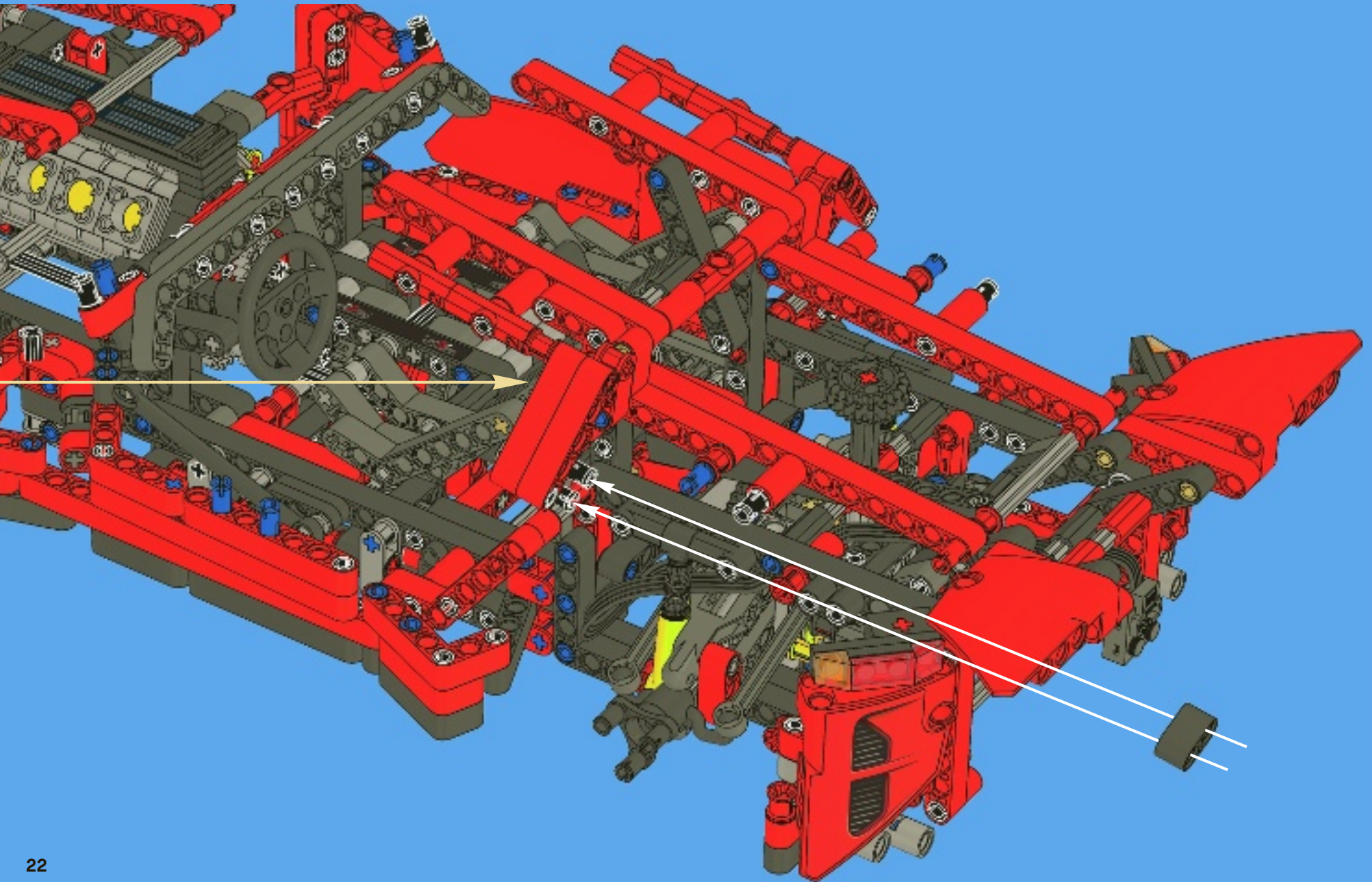



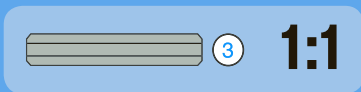
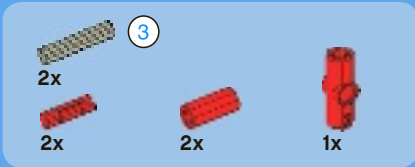

# 114

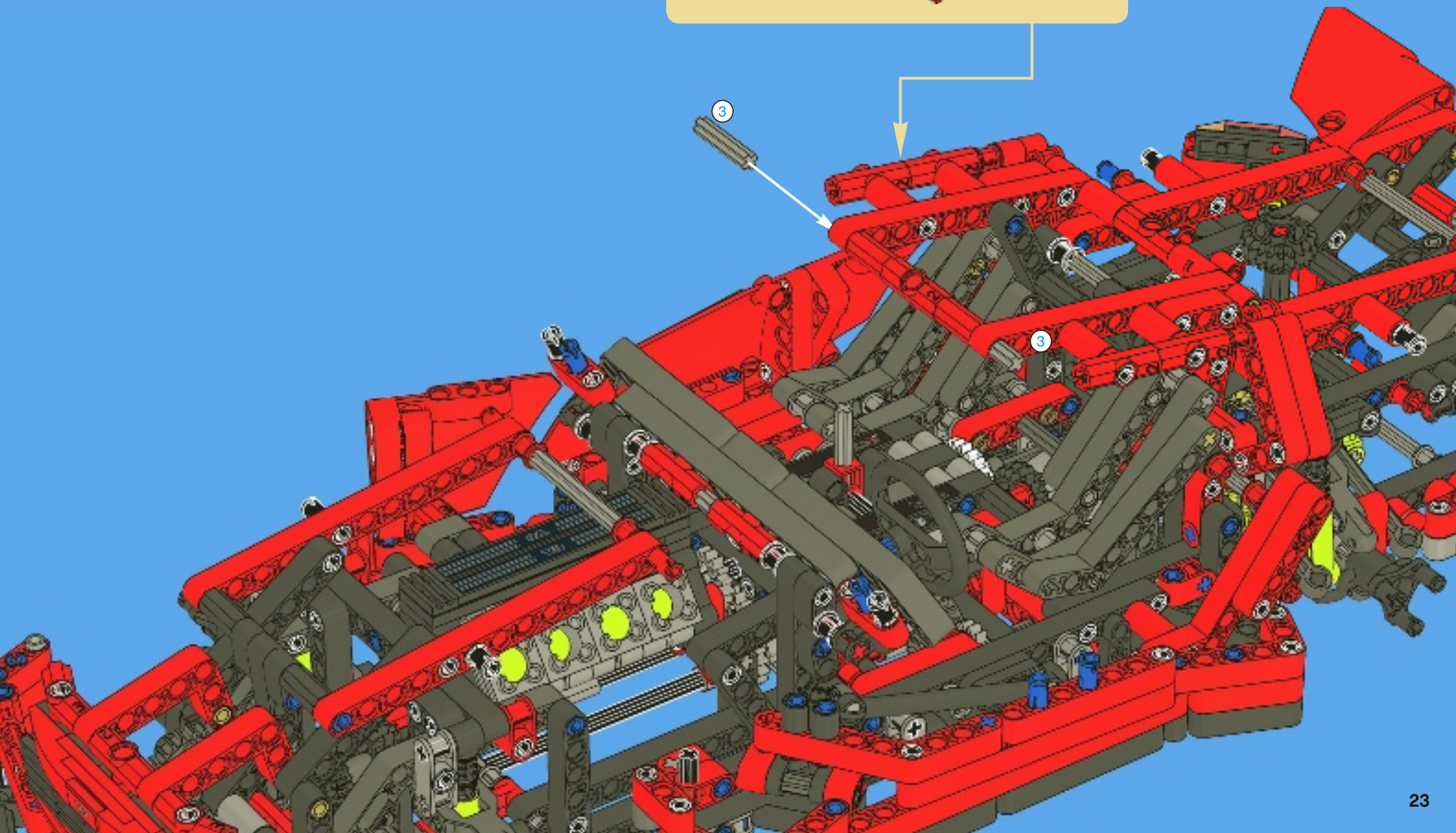
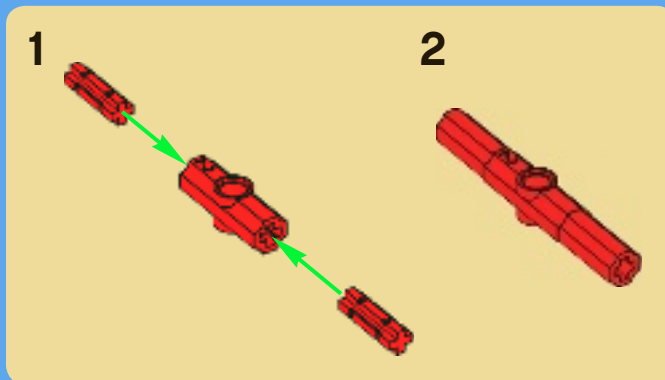

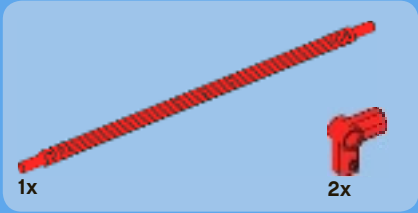
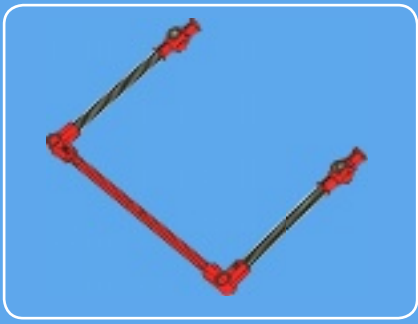

1

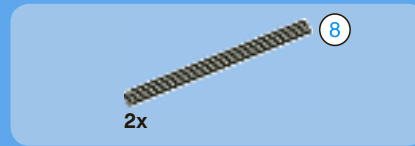
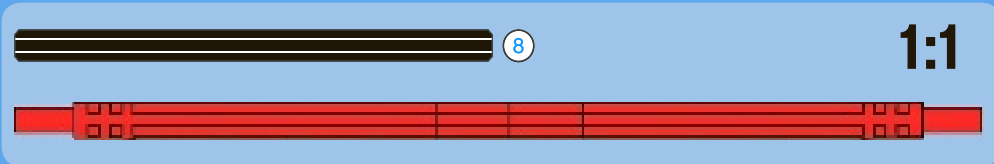
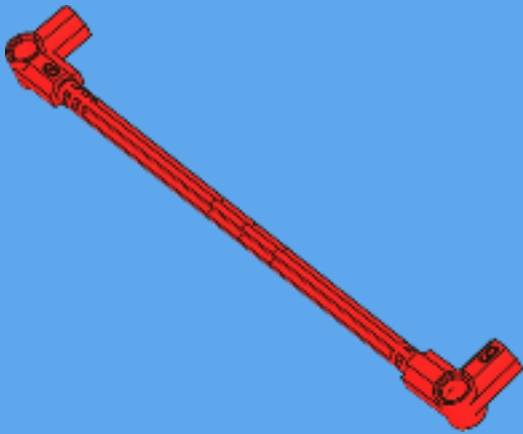

2

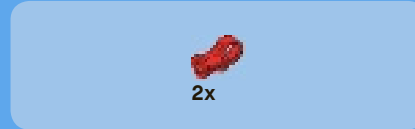

3

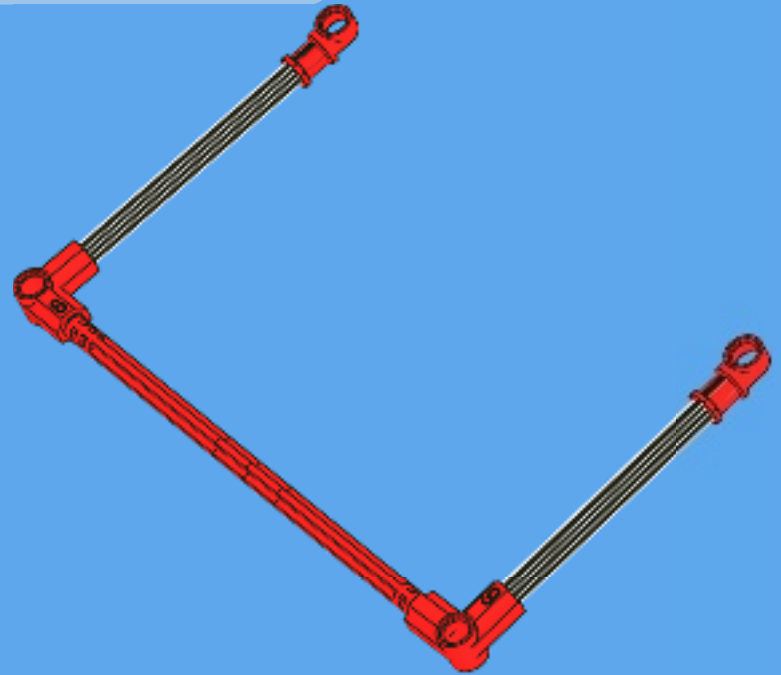



2x  2x 

4

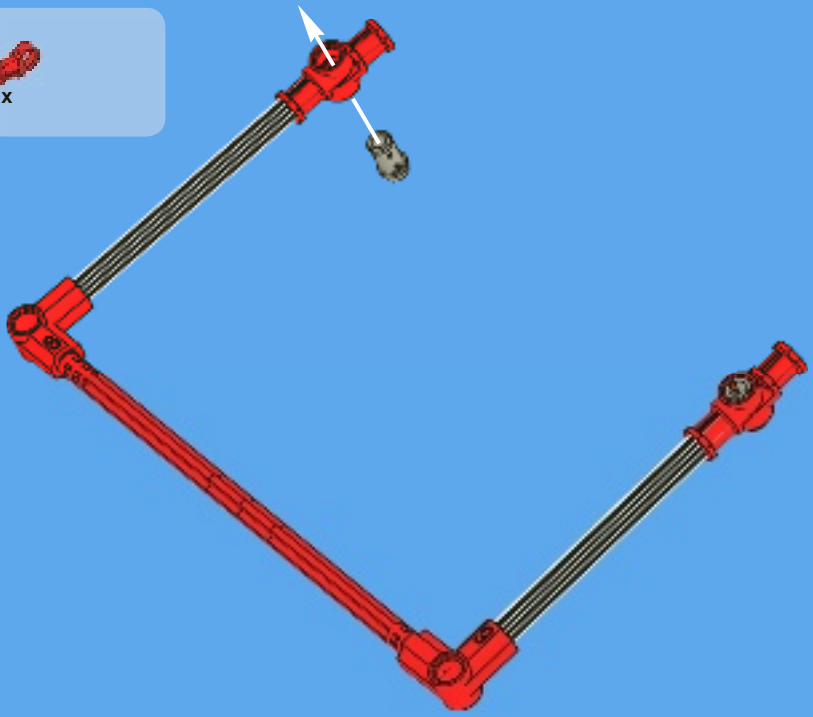

115

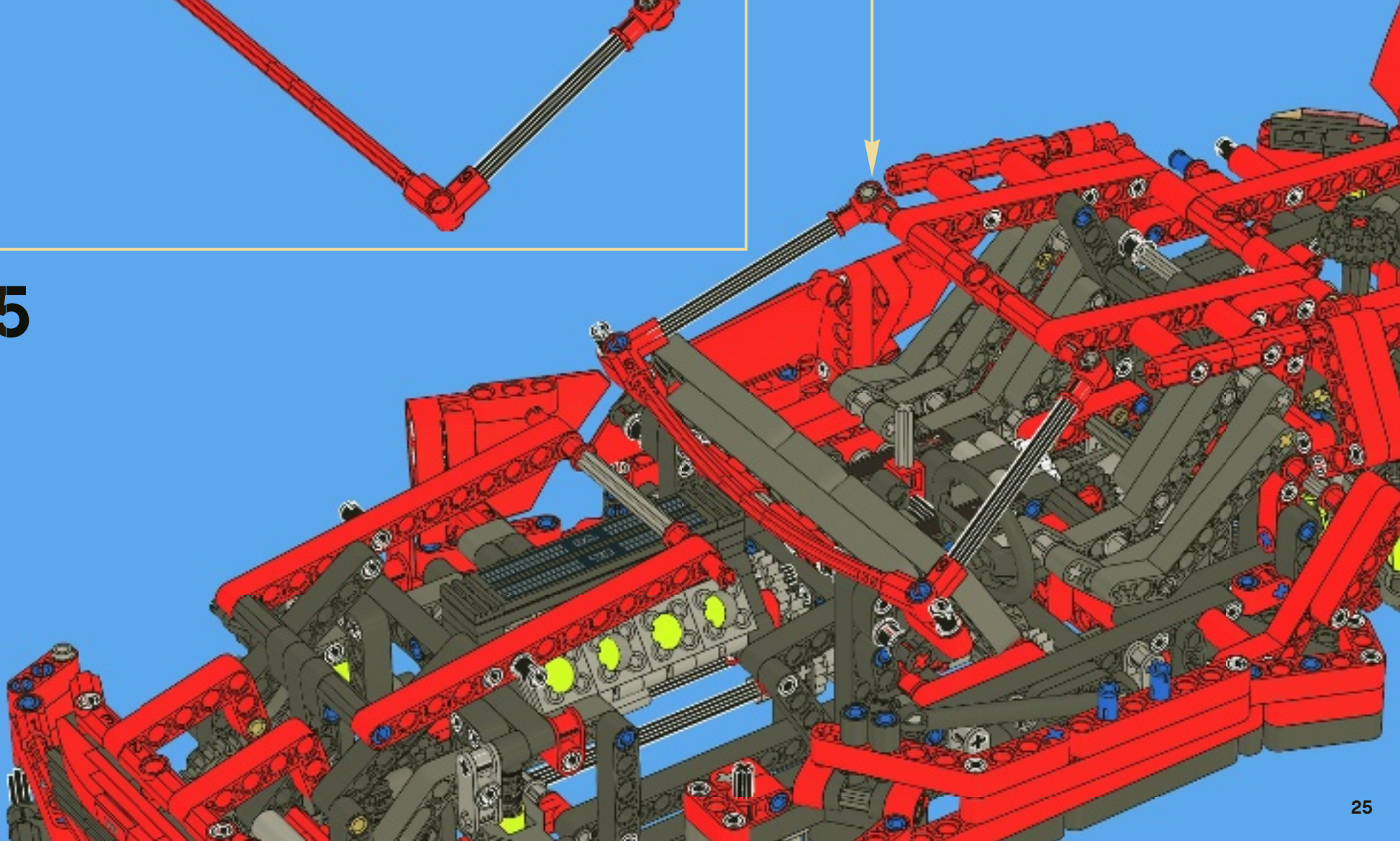



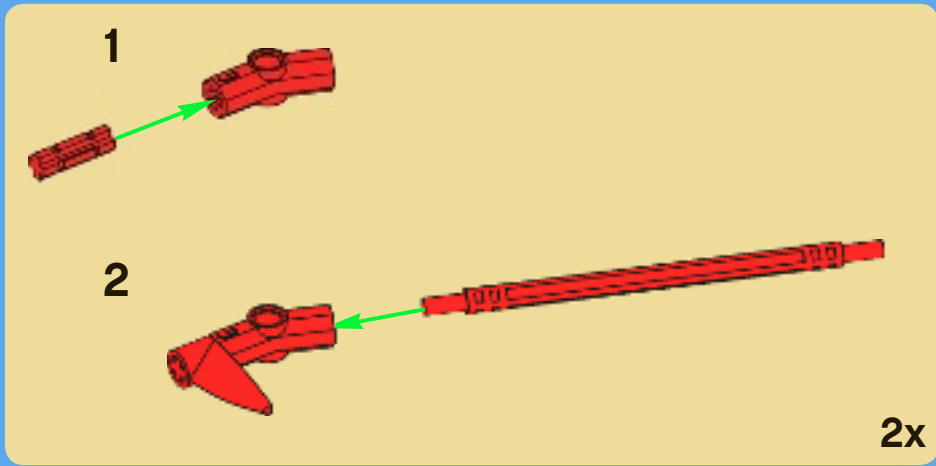
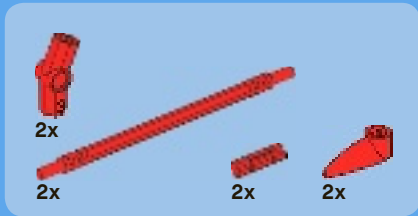

116

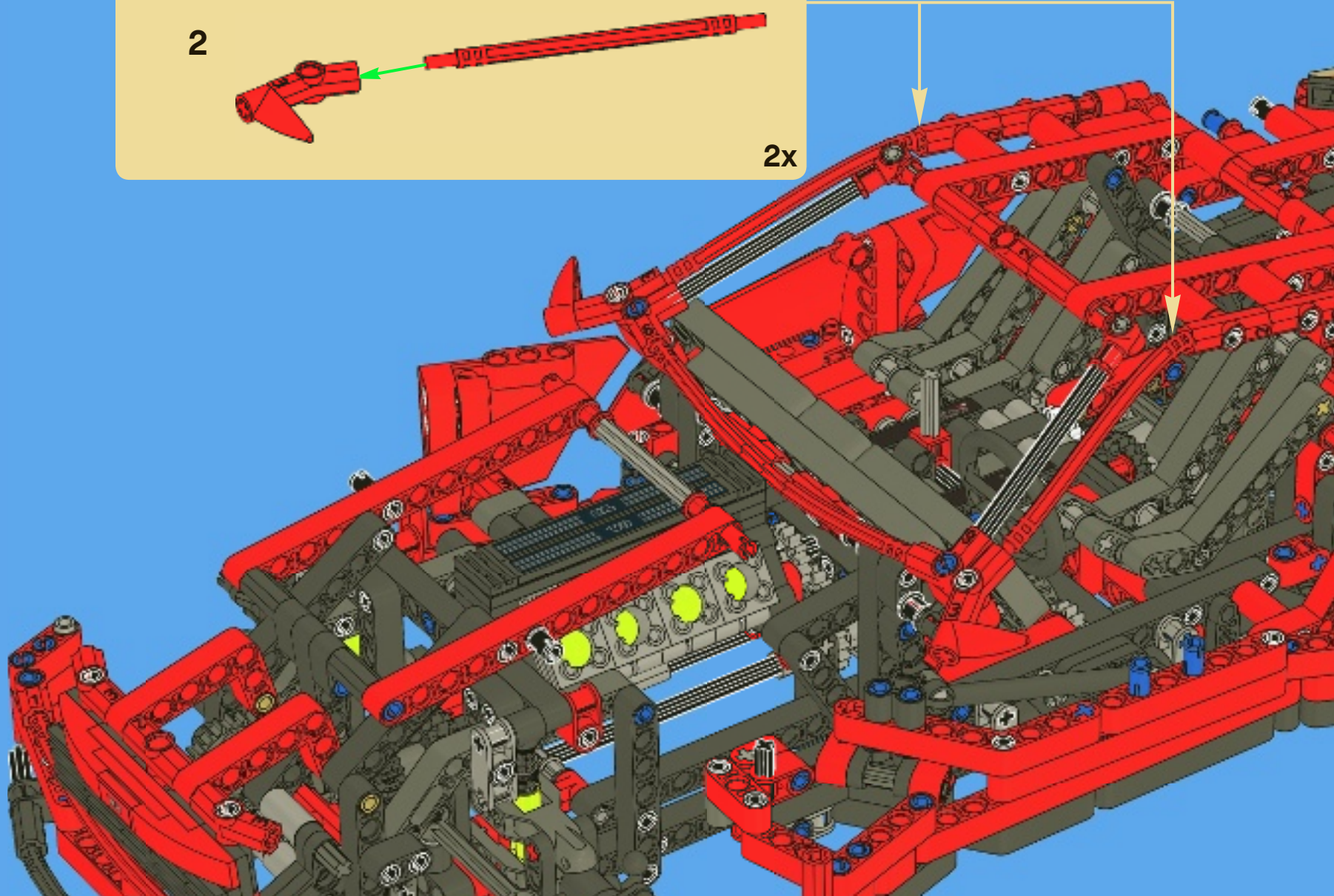



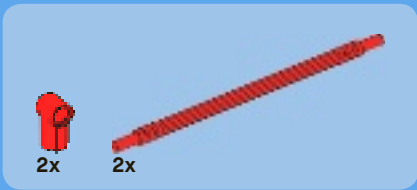

117

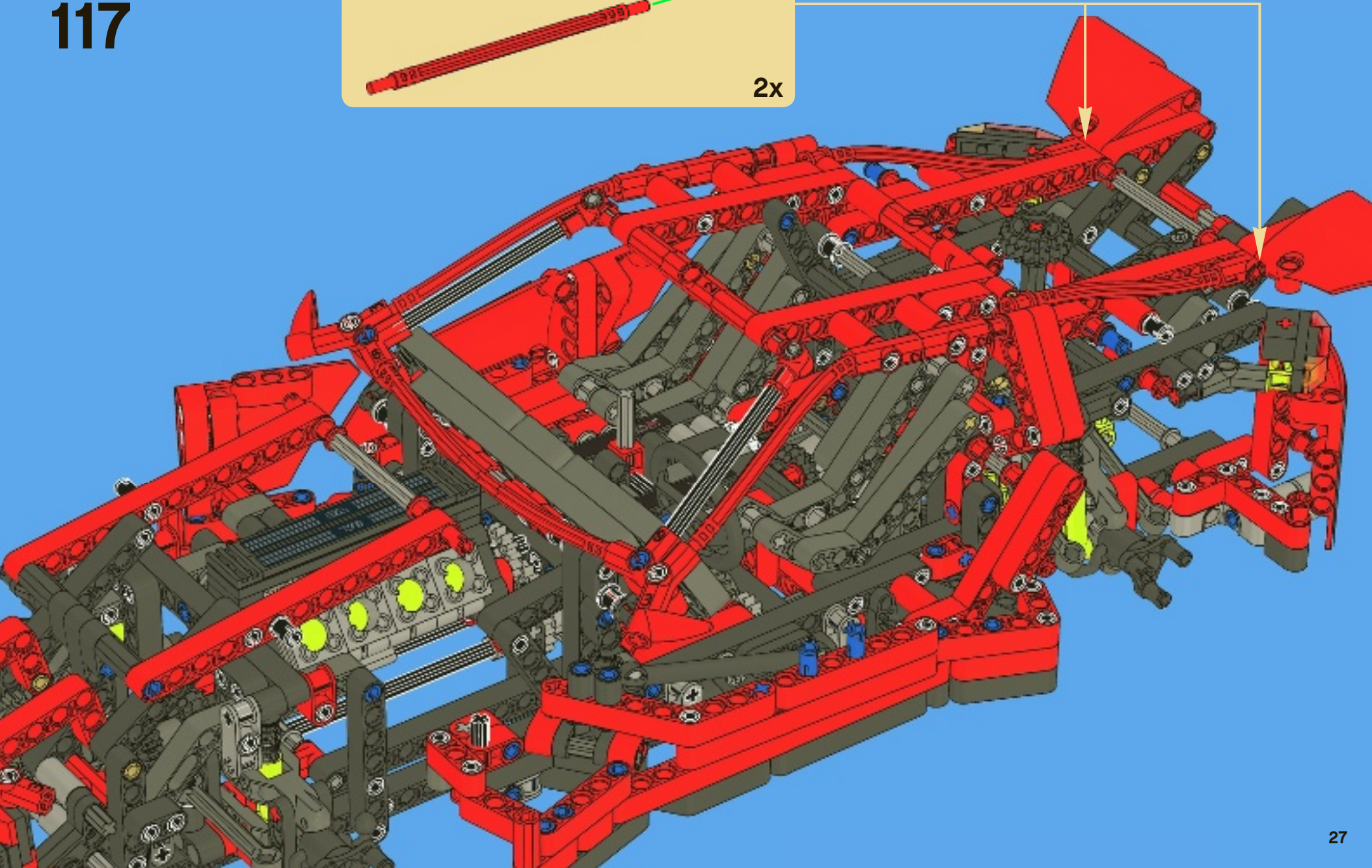
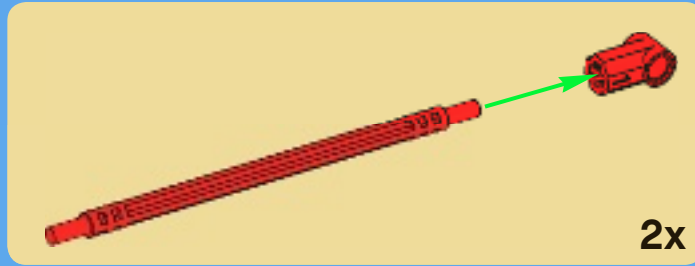



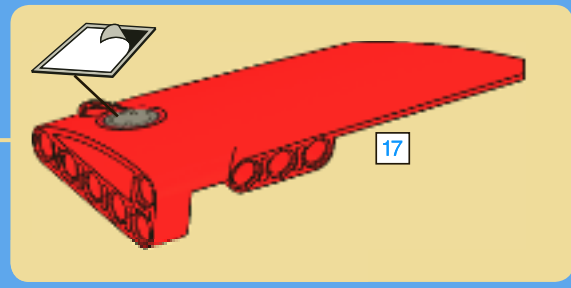
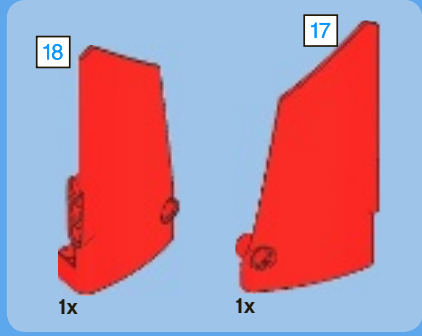

# 118

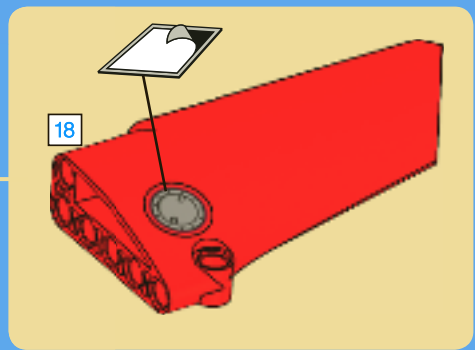

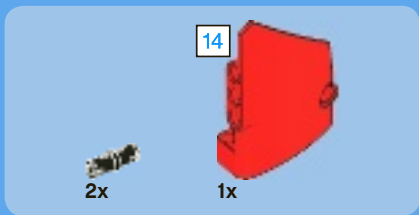

1

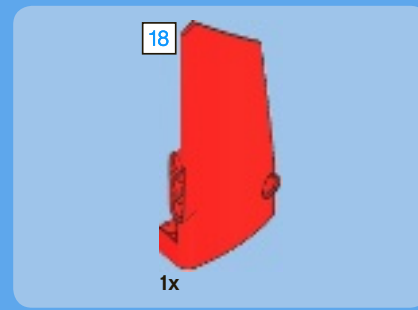
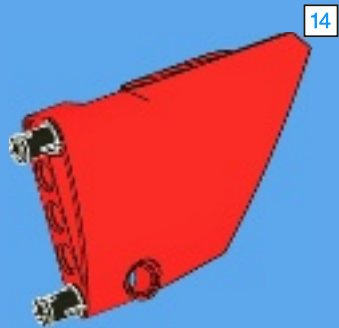

2

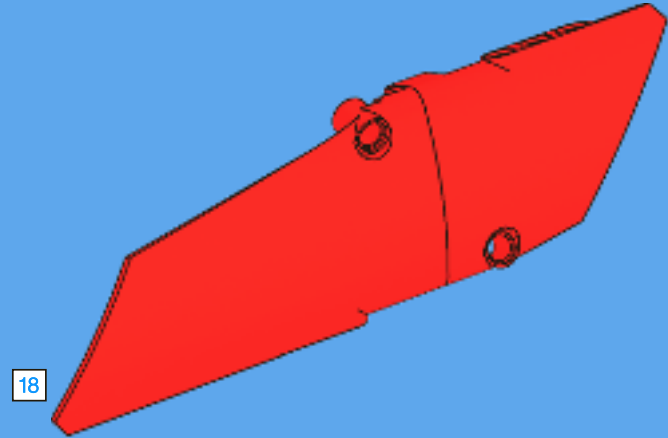

3

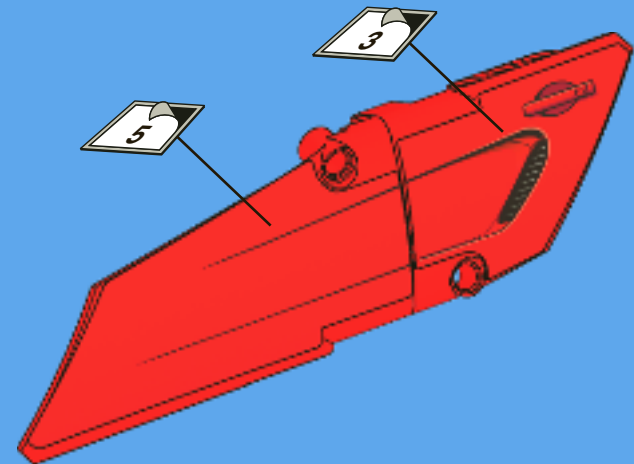



119

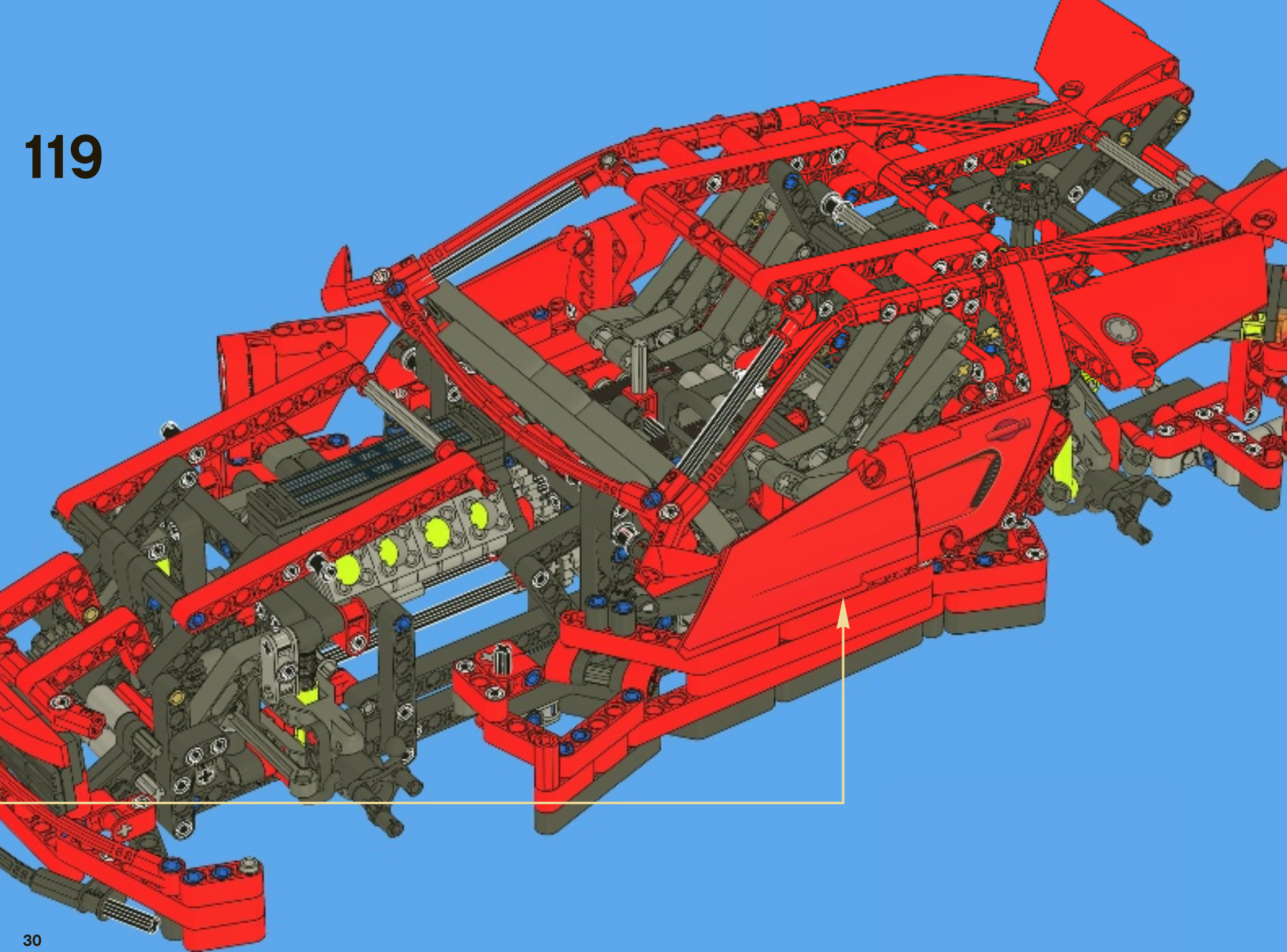



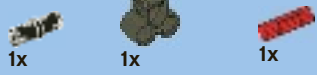

1

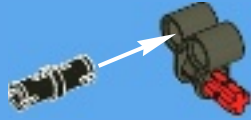

2

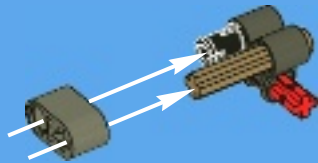

3



4

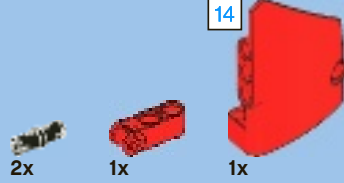

5

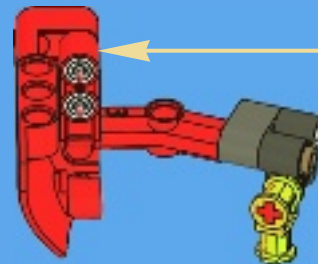

2

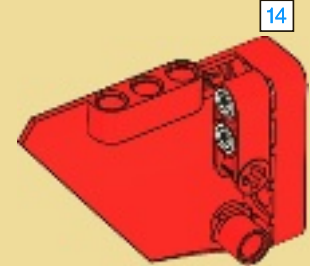

3



120

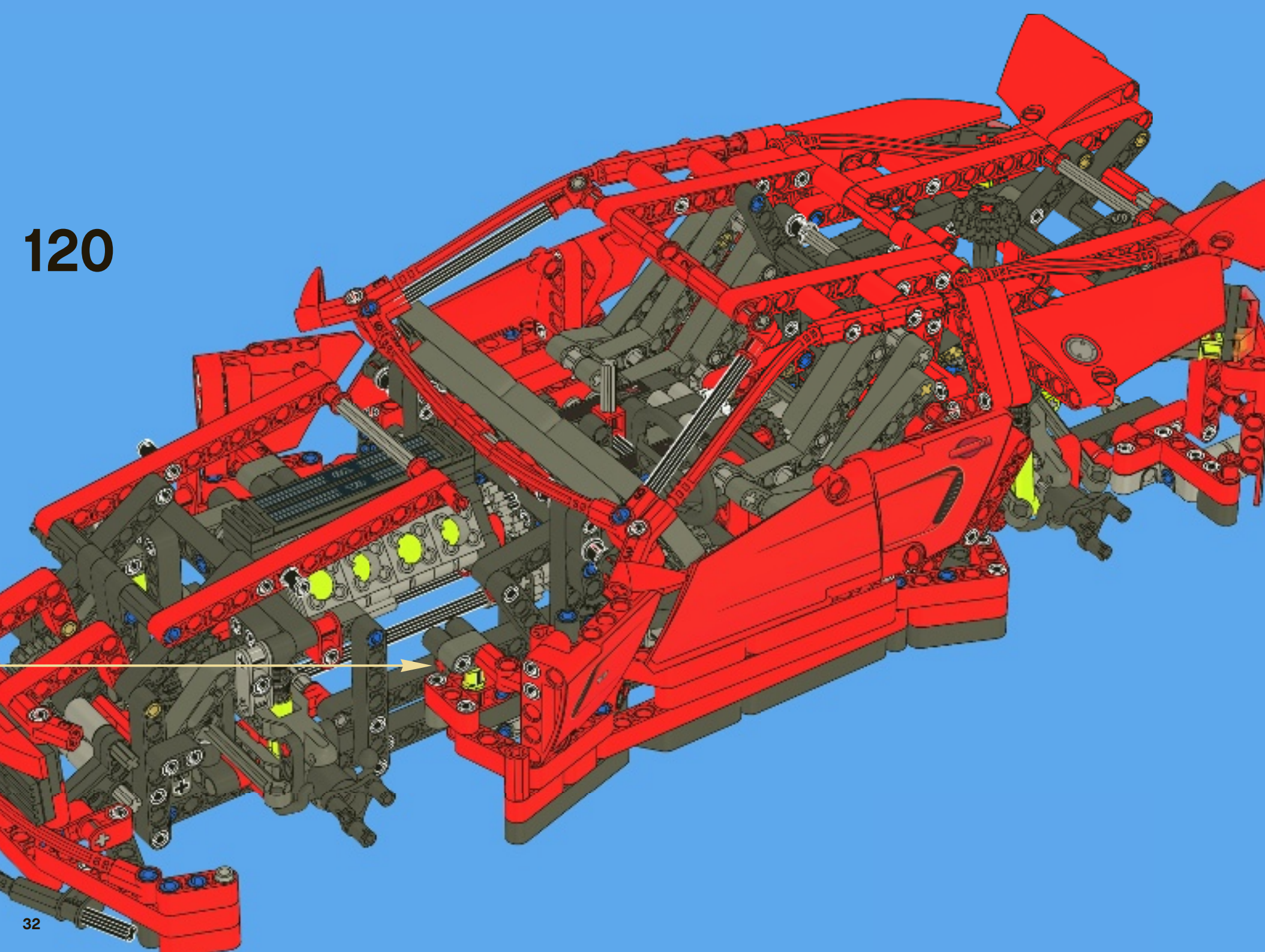



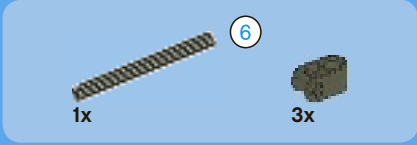

1



2

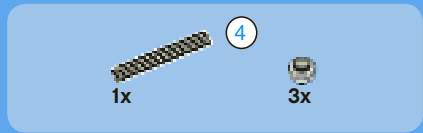
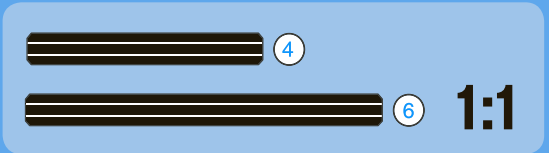

3

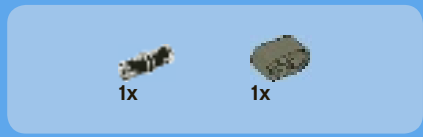
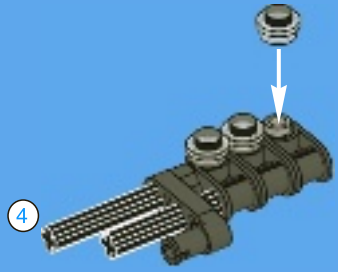

4

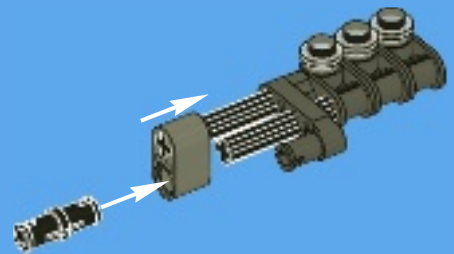



2x

5



1x

1x

1x

1x

6



1

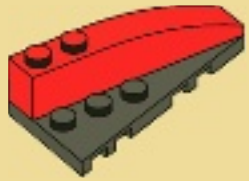

2

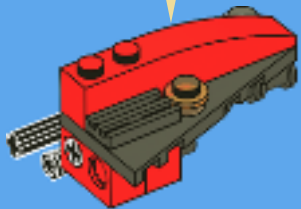
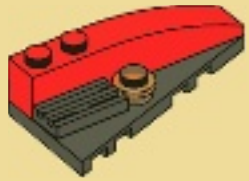

2x

1x

1x

7

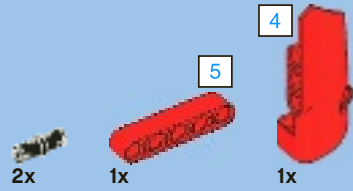

1

5



2

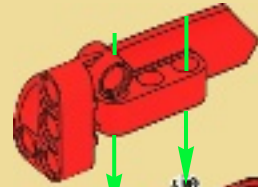

4

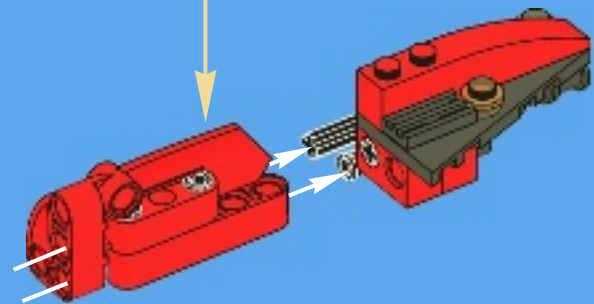
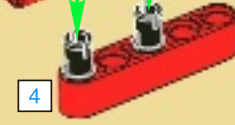

5

1:1



121

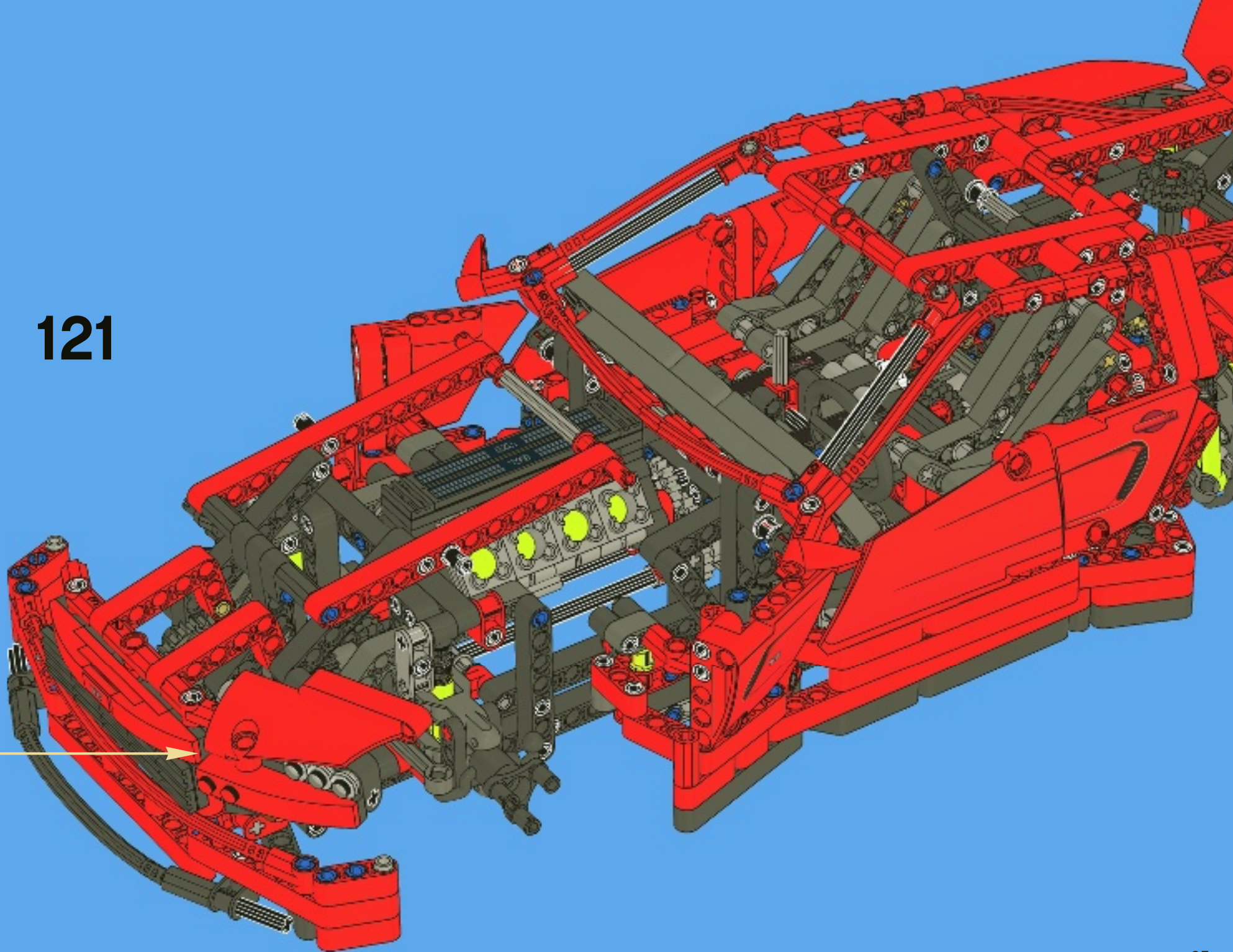

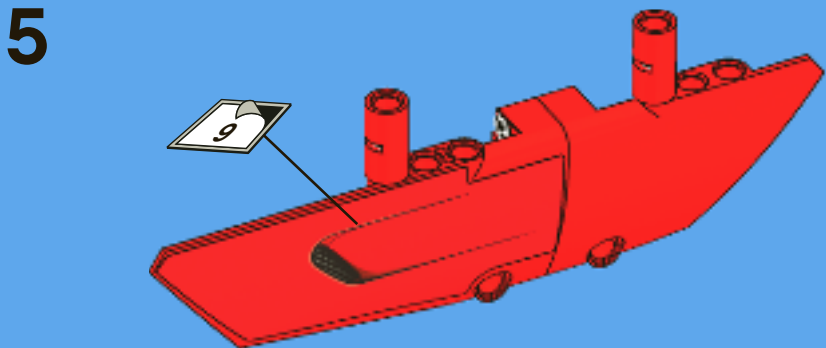
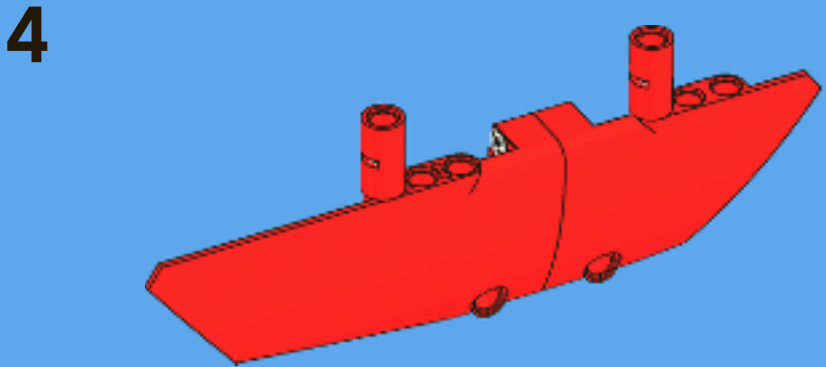
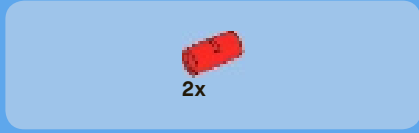
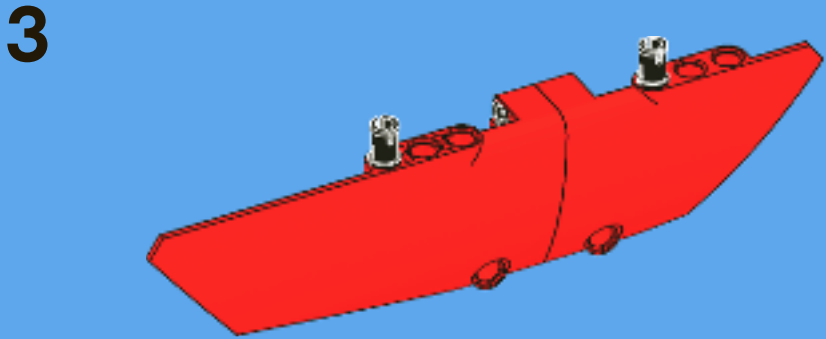
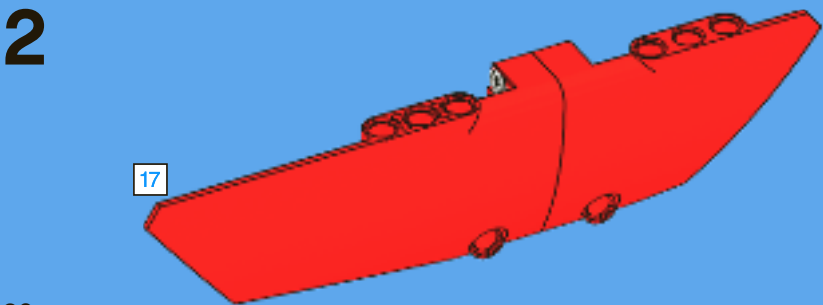
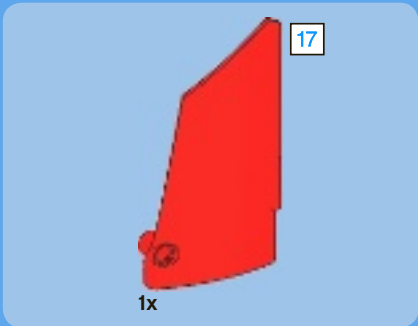
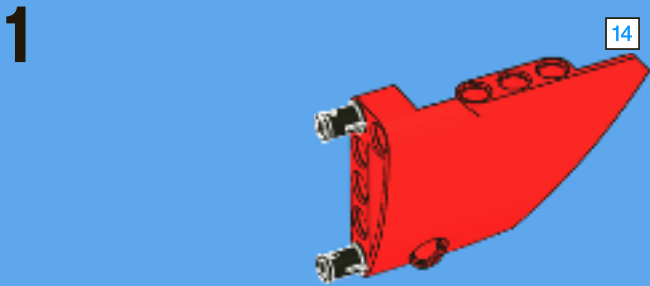
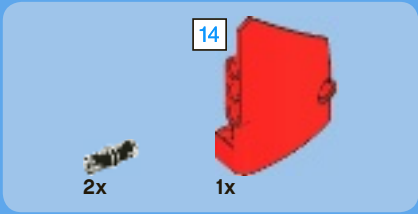
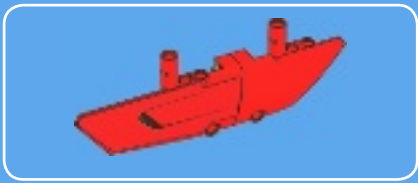



122

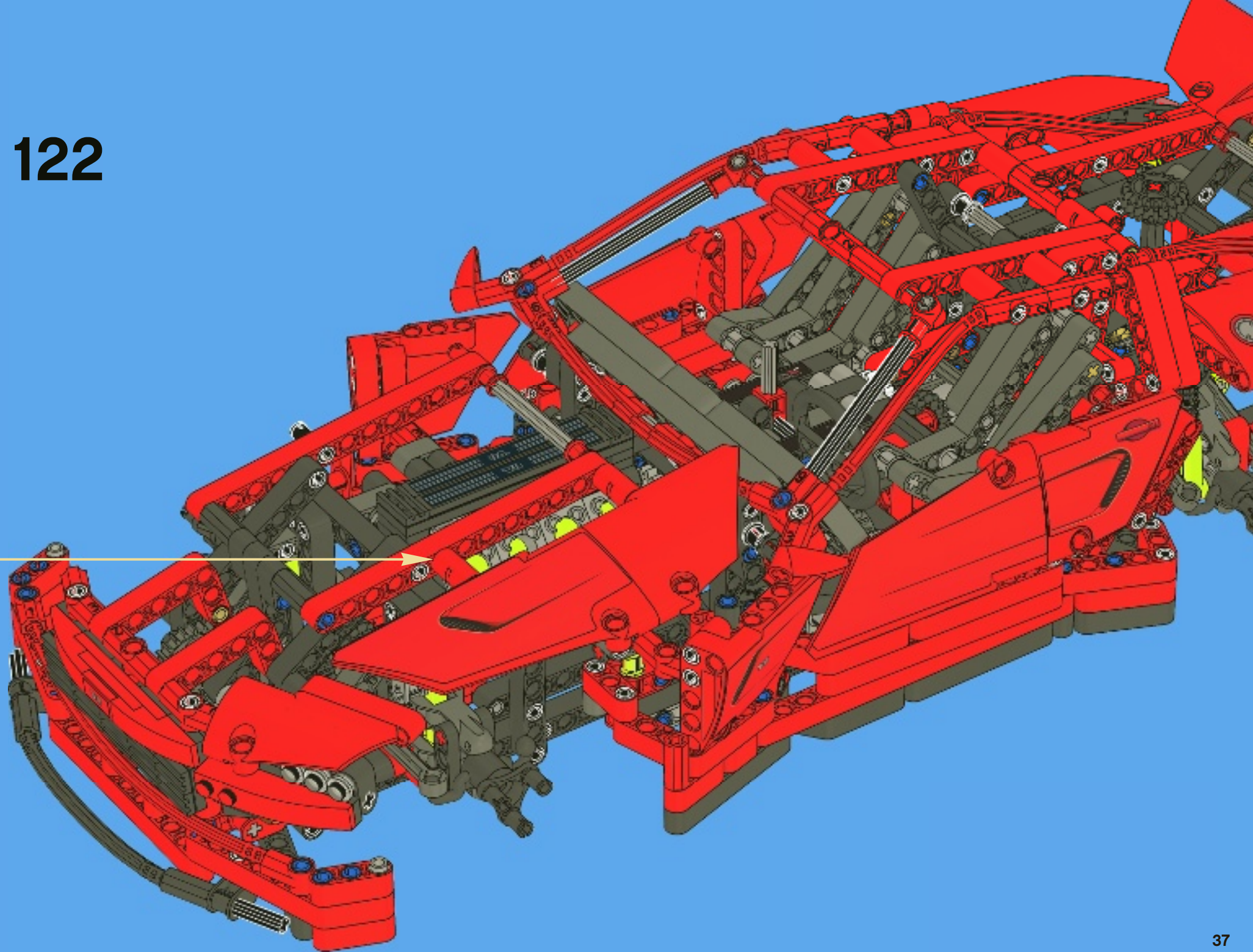



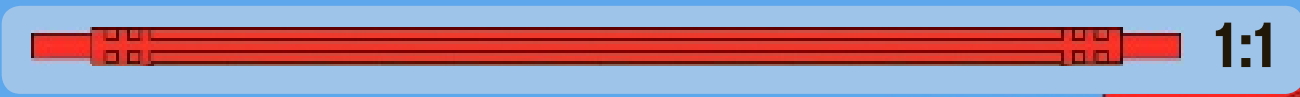
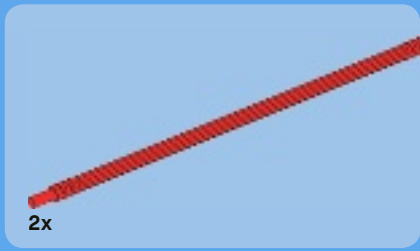

123

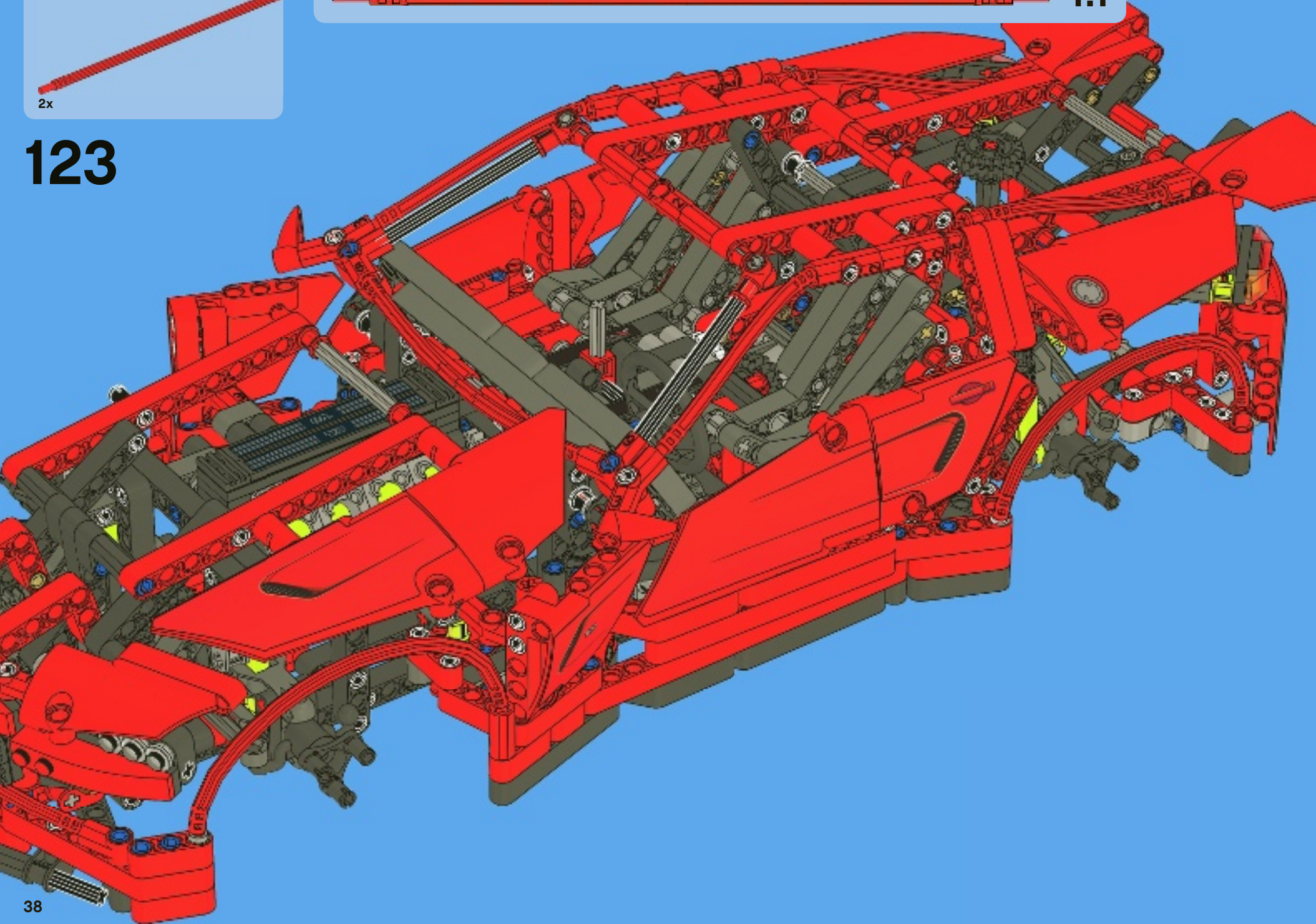



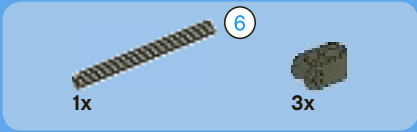

1



2

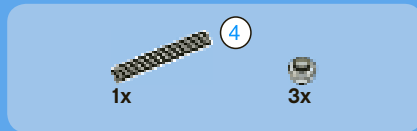
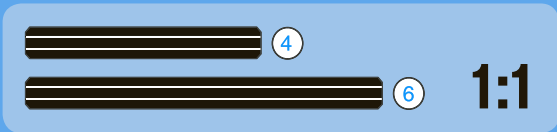

3

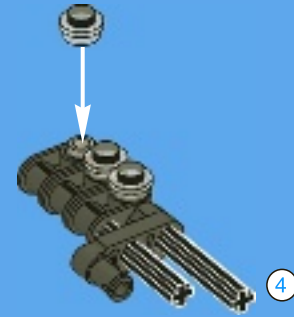

4

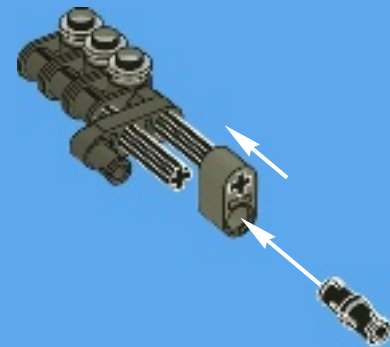



2x

5

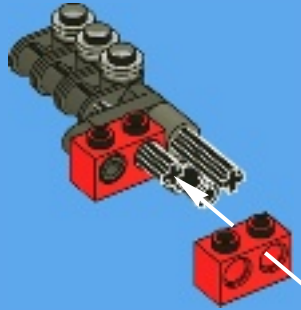

1x

1x

1x

1x

6

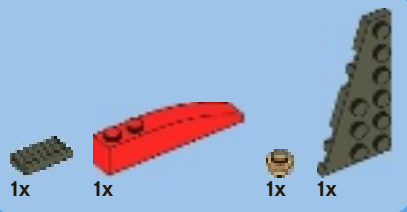

1

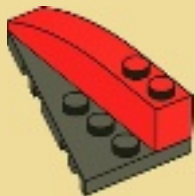

2

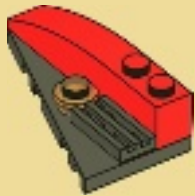

2x

1x

5

3

1x

7



5

1:1

1



5

2

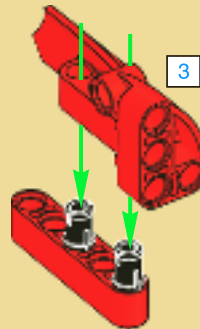

3

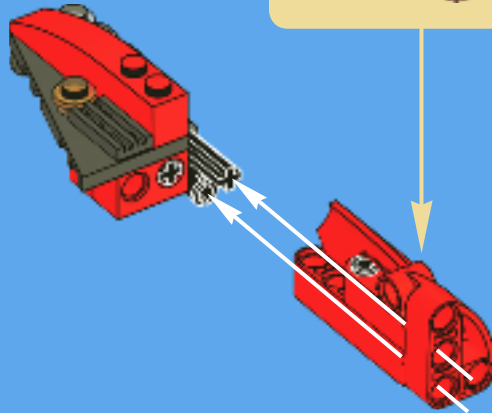



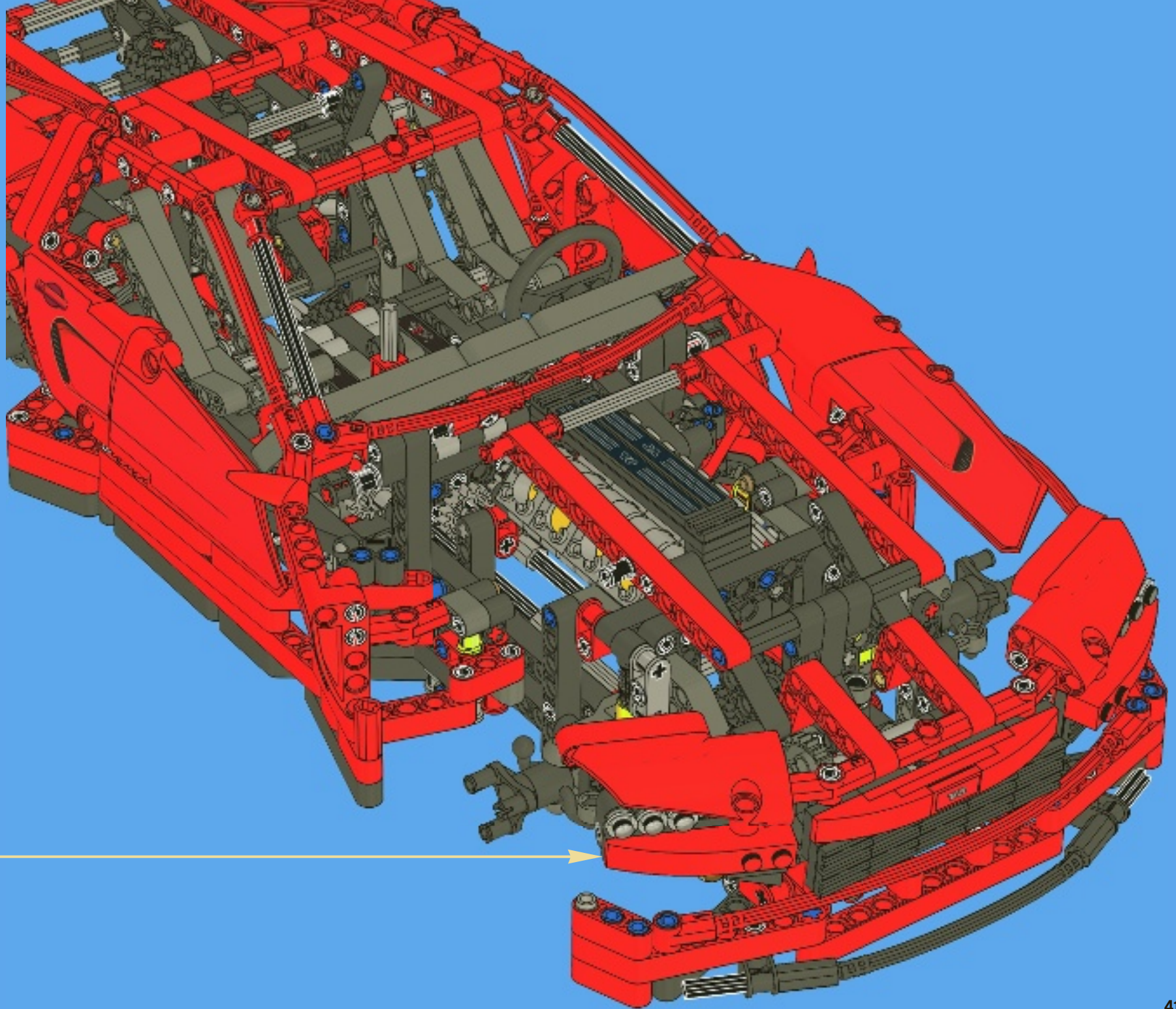

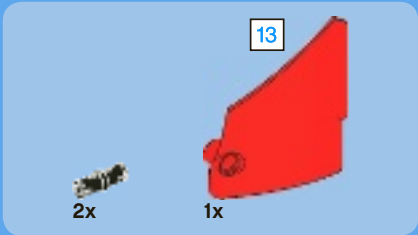
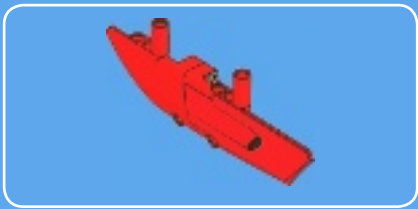

1

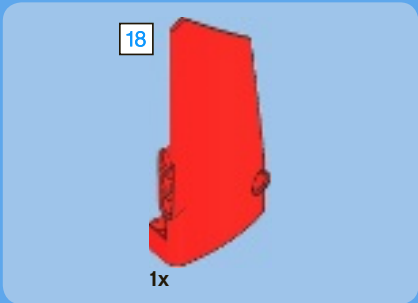
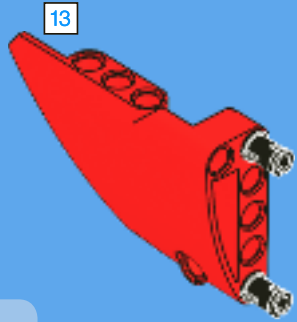

2

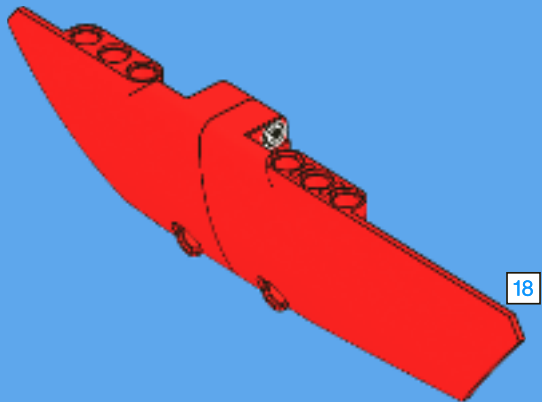

3

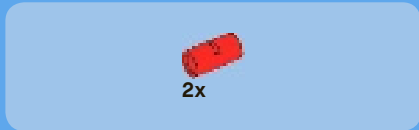
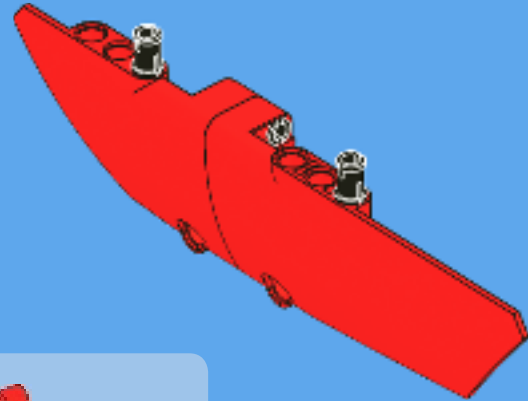

4

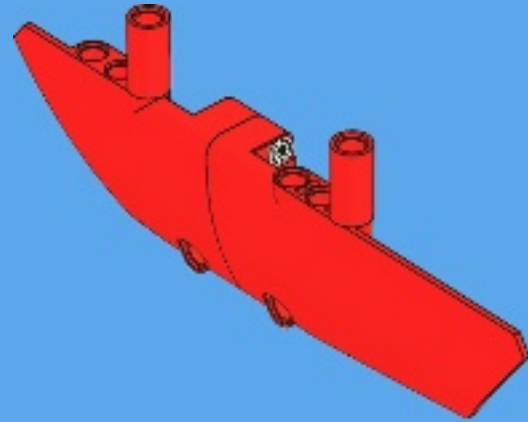

5

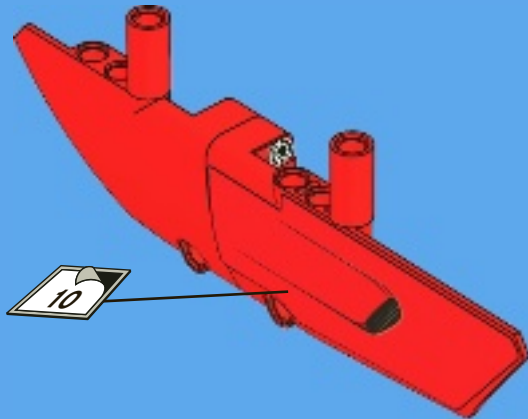



125

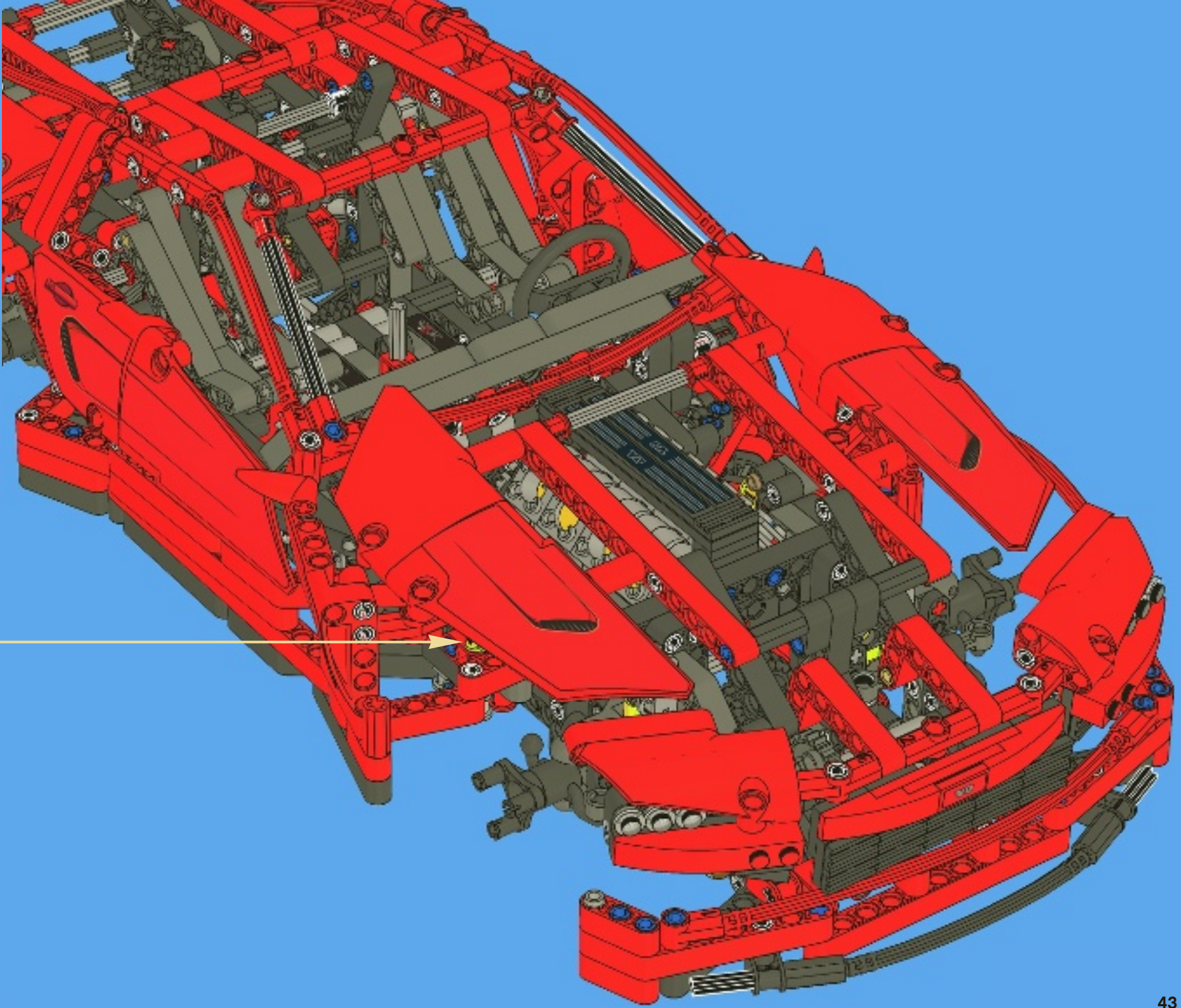



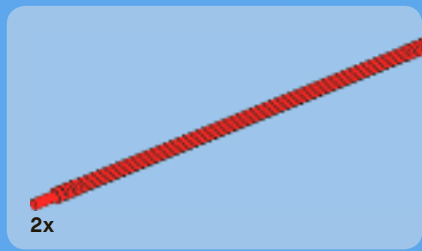

126

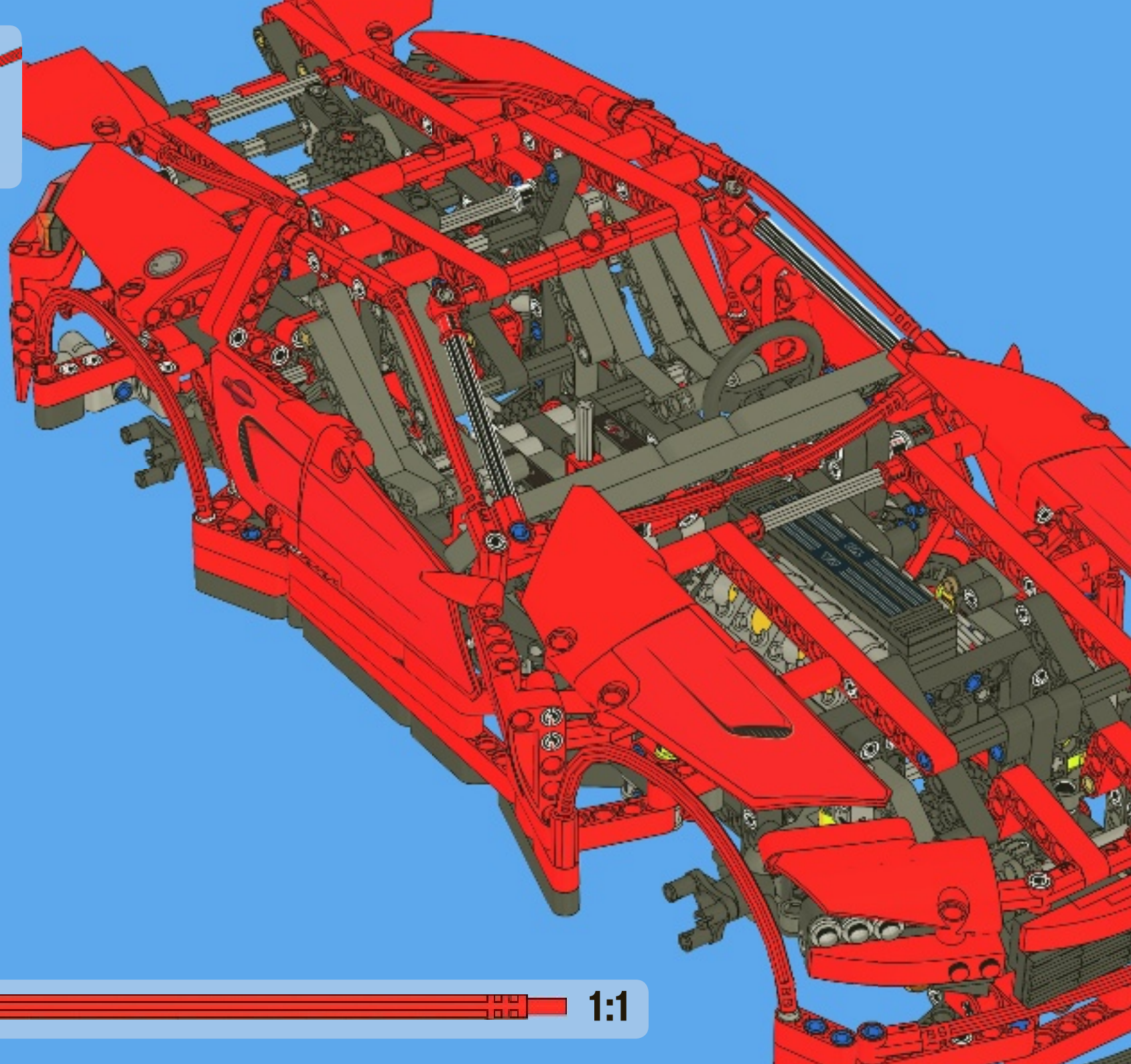





127

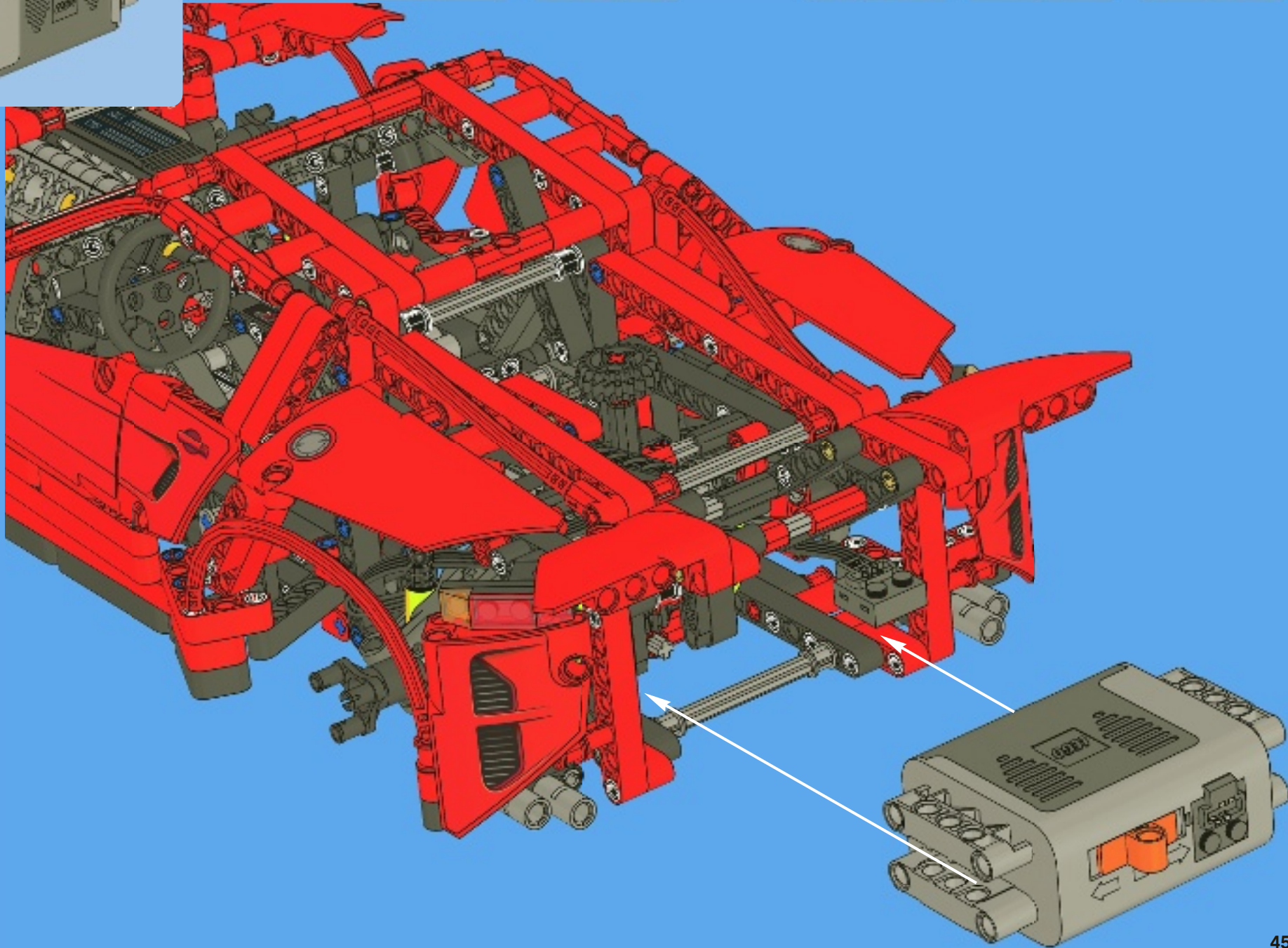



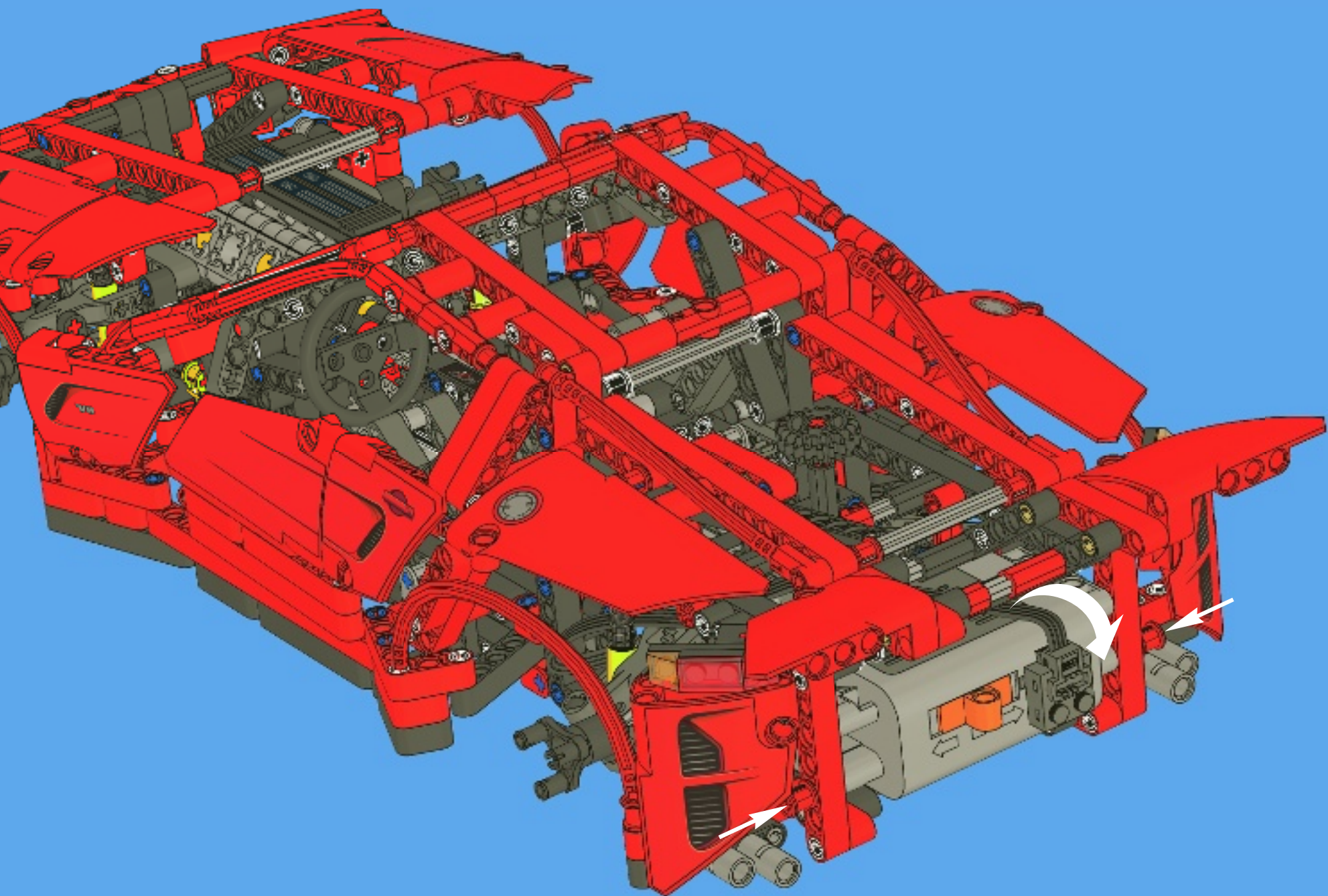



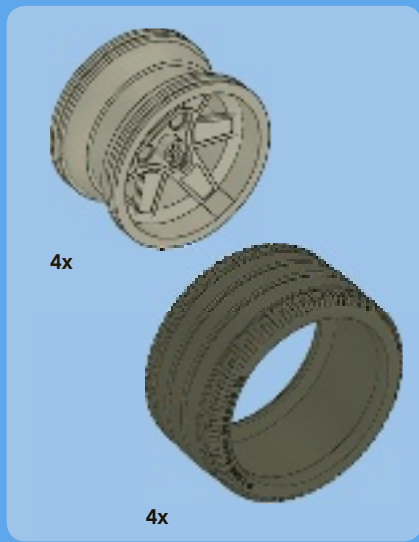

129

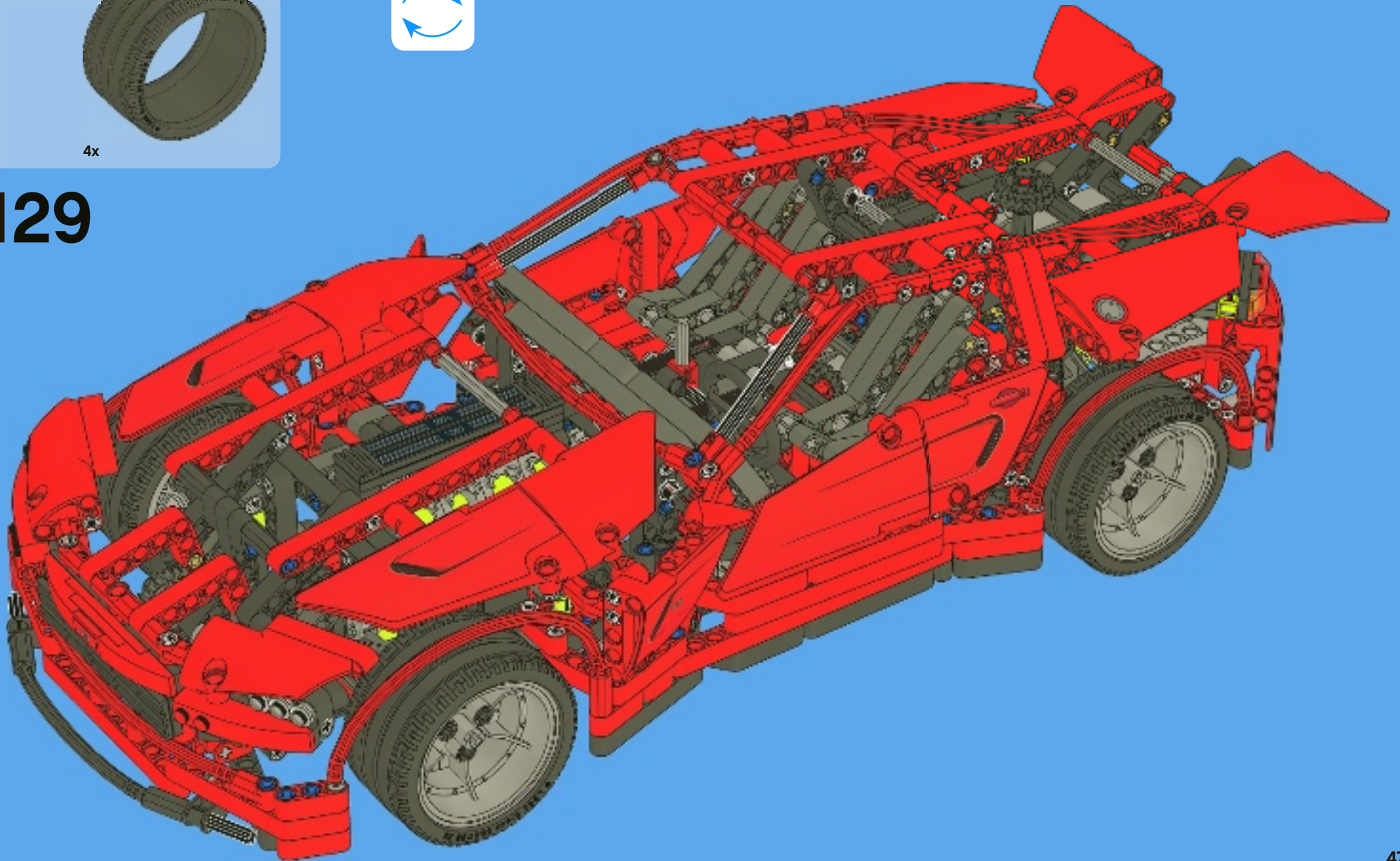

11x  
4254606  
36x  
4188298  
11x  
4175442  
8x  
4186678  
2x  
4185661

2x  
4612557

2x  
4501304

1x  
4566049

5x  
4614802

12x  
4153718  
4x  
4141270

16x  
4143154

12x  
4142132

4x  
4495933

2x  
4254591

4x  
4141743

5x  
4562805

5x  
4522938

2x  
4542575

6x  
4513174  
2x  
4189131

20x  
4526984  
33x  
4140806

1x  
4270473  
2x  
4278957

2x  
4520782

2x  
4160390

1x  
371021

1x  
366621

1x  
4540801

5x  
4540825

3x  
4540799

1x  
4540798

5x  
4543489

3x  
4540800

4x  
4142622  
10x  
4107800

8x  
4112203  
2x  
4119474  
54x  
4206482

72x  
4514553  
1x  
4540381

5x  
4186017

11x  
4514554

2x  
4207456

3x  
4565452

35x  
4142865

1x  
306921  
2x  
4185664

4x  
4179355

4x  
4614799

15x  
4234429

6x  
4612443

219x  
4121715  
2x  
4119589

8x  
4140801  
6x  
4563044

2x  
4233487  
6x  
302326

2x  
302126

14x  
241226

2x  
281726

2x  
4141810

1x  
4283047

2x  
416226

2x  
383226

4x  
4614801

2x  
371026  
1x  
4283046

12x  
4177444

12x  
4120017

8x  
4142135

4x  
4142823

3x  
4128593

20x  
4495935



2x  
4112282

6x  
4154767

8x  
4156150

3x  
4522933



**Customer Service**  
Kundenservice  
Service Consommateurs  
Servicio Al Consumidor  
[www.lego.com/service](http://www.lego.com/service) or dial  
00800 5346 5555 :   
1-800-422-5346 : 



16x 4512363  
 6x 4107085  
 9x 4173668  
 8x 4140430  
 2x 4162857  
 12x 4107828  
 4x 4142543  
 4x 4227853  
 2x 4141300  
 5x 4177431  
 4x 4177430  
 1x 4562009  
 1x 4125213  
 1x 4501290  
 12x 4542573

2x 4184169  
 21x 370526  
 9x 370626  
 5x 370726  
 1x 373726  
 2x 370826  
 6x 3005740  
 2x 4244363  
 2x 4189801  
 5x 4566927  
 2x 4244369  
 2x 4222960  
 16x 4211622  
 4x 4211714  
 6x 4538007  
 12x 4211621  
 8x 4211375

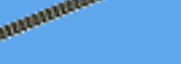
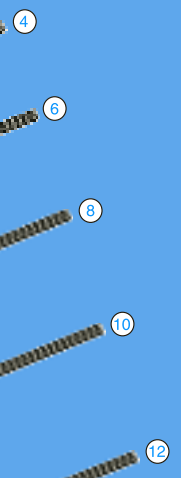

4x 4211573  
 1x 4560175  
 12x 4211483  
 4x 4211561  
 4x 4211510  
 7x 4211807  
 16x 4512360  
 6x 4526985  
 9x 4211865  
 2x 4296059  
 4x 4268659  
 2x 4278756  
 8x 4211379  
 2x 4525904  
 8x 4234251  
 8x 4640536  
 1x 4539880



14x 4515183  
 2x 4610374  
 2x 4210688  
 6x 4552349  
 4x 4210749  
 42x 4211815  
 19x 4211639  
 8x 4211805  
 1x 4535768  
 4x 4211845  
 1x 4506078  
 1x 4506083

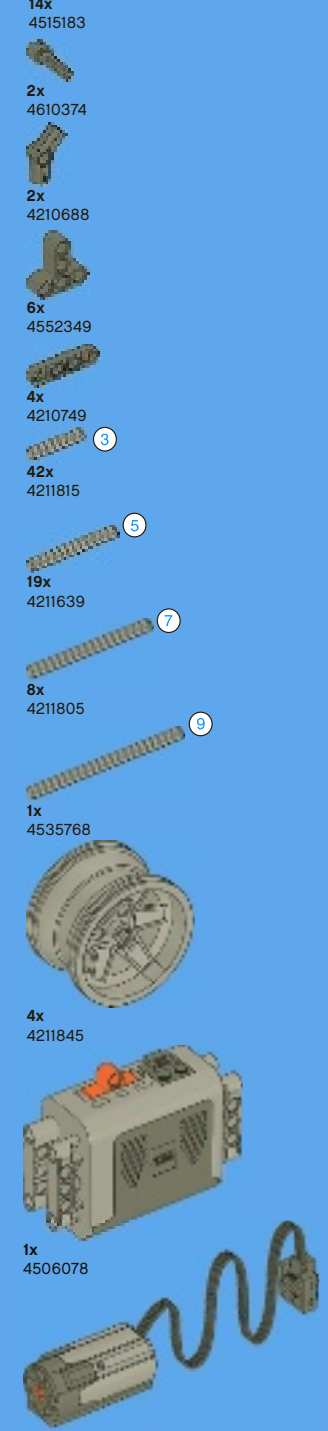

3x 4210987  
 5x 4514559  
 8x 4237267  
 1x 4514558  
 1x 4525184  
 6x 4629920  
 8x 4523398  
 10x 4560177  
 6x 4499858  
 3x 4210686  
 4x 4281516  
 6x 4210668  
 1x 4522937



# power functions™

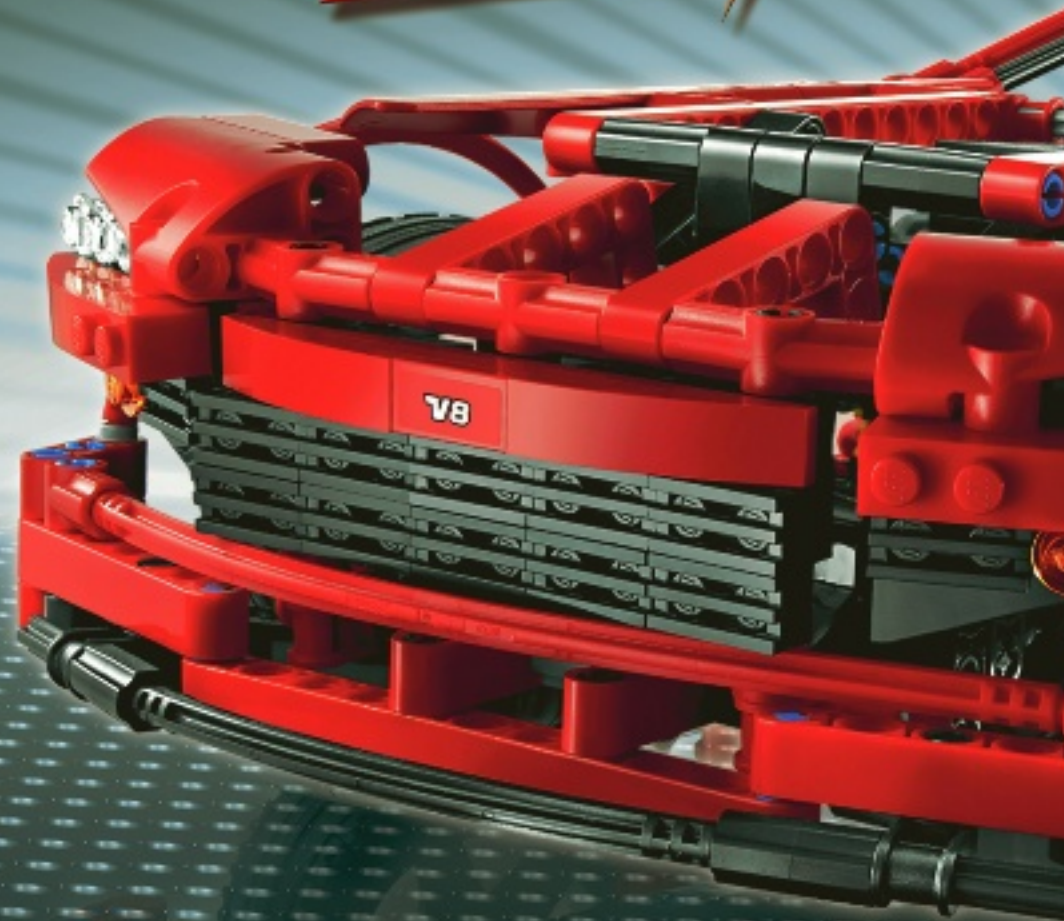









# TECHNIC

Alternative model building instructions only available for download from:  
 Bauanleitungen für alternative Modelle stehen ausschließlich als  
 Download zur Verfügung unter:  
 Les instructions de montage du modèle alternatif sont uniquement  
 disponibles sur internet dans la rubrique « Montage » du site.  
 Las instrucciones de construcción del modelo alternativo solo pueden  
 obtenerse a través de:  
 Instrucciones de construcción de modelo alternativo disponibles para  
 descargar a partir de:  
 Model building instructions for alternative models available for  
 download from:



[TechnicLEGO.com](http://TechnicLEGO.com).







# TECHNIC

8069







[www.LEGOclub.com](http://www.LEGOclub.com)



LEGO® Club Email



LEGO® Club Magazine

**LEGO club**™

**FREE! GRATIS! GRATUIT!**

**SIGN UP ONLINE!**  
[www.LEGOclub.com](http://www.LEGOclub.com)

VISIT THE WORLD'S  
BIGGEST LEGO® SHOP!  
[www.LEGOshop.com](http://www.LEGOshop.com)

GO TO  
[www.LEGOclub.com](http://www.LEGOclub.com)

00800 5346 5555\*

1-866-534-6258 • 1-877-518-5346

US & Canada only

Canada seulement



\* Freephone. Mobile charges may apply.  
\* Numéro sans frais. Des frais peuvent s'appliquer avec les téléphones cellulaires.  
\* Gebührenfrei, Kosten für Anrufe aus Mobilfunknetzen können abweichen.  
\* Gratis telefoonnummer vanaf vaste lijn.  
\* Det er et gratis nummer, når du ringer fra fasttelefon.  
\* Det är gratis, när du ringer från en fast telefon.  
\* Numéro sans frais. Des frais peuvent s'appliquer avec les téléphones portables.



Technic.LEGO.com







# WIN!

Go to [www.LEGOsurvey.com/product](http://www.LEGOsurvey.com/product) to fill out a survey for a chance to win a cool LEGO® Product. No purchase necessary. Open to all residents where not prohibited.



## [www.LEGOsurvey.com/product](http://www.LEGOsurvey.com/product)

### GEWINNE!

Nimm an der Umfrage auf [www.LEGOsurvey.com/product](http://www.LEGOsurvey.com/product) LEGO teil und hab die Chance ein cooles LEGO® Produkt zu gewinnen!

Die Teilnahme am Gewinnspiel führt zu keinerlei Kaufverpflichtungen. Teilnahme in allen nicht ausgeschlossenen Ländern möglich.

### WIN!

Ga naar [www.LEGOsurvey.com/product](http://www.LEGOsurvey.com/product), vul een enquêteformulier in en maak kans op een cool LEGO® product.

Geen aankoopverplichting. Iedereen mag deelnemen, uitgezonderd ingezetenden van landen waar een enquêteverbod geldt.

### GAGNE!

Visite [www.LEGOsurvey.com/product](http://www.LEGOsurvey.com/product) pour répondre à un questionnaire et avoir une chance de gagner un produit LEGO® très cool!

Aucune obligation d'achat. Ouvert à tous les résidents des pays autorisés.

### 当てよう!

[www.LEGOsurvey.com/product](http://www.LEGOsurvey.com/product) にアクセスして、アンケートにご記入ください。当選者にはレゴ®製品を差し上げます。

お買い上げの必要はありません。禁止されていない限り、すべての皆様にご利用いただけます。