

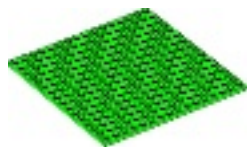

CITY

4440





+



2x

1

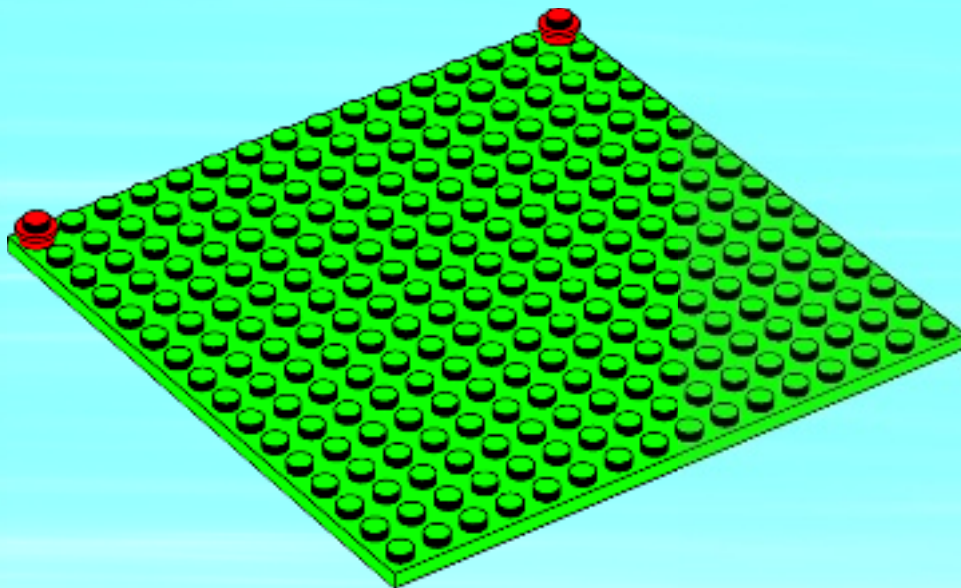

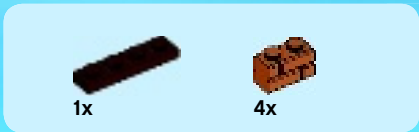

2

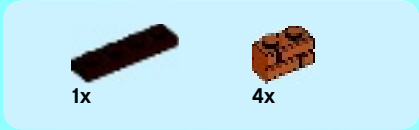
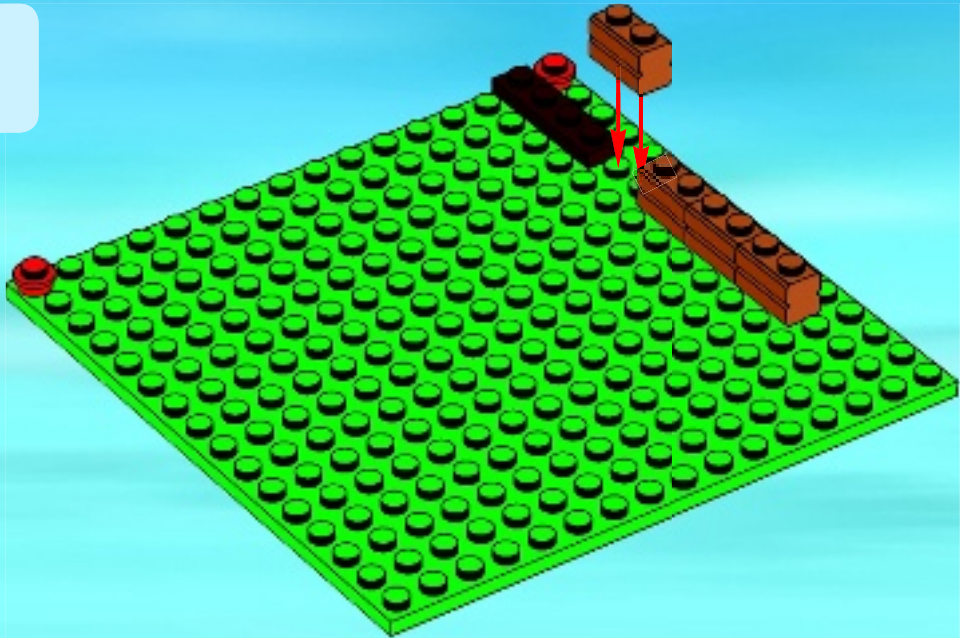

3

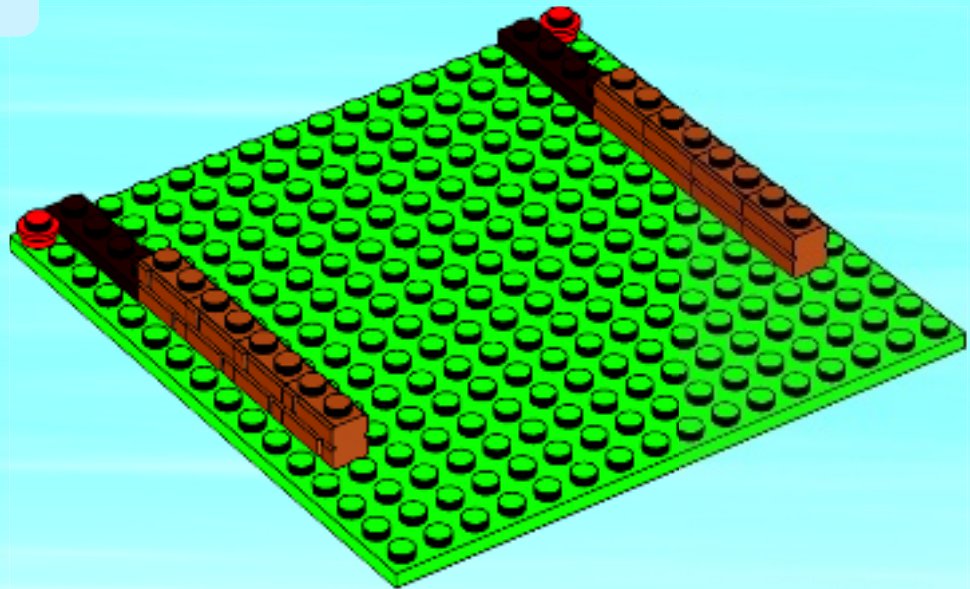



2x



2x

4

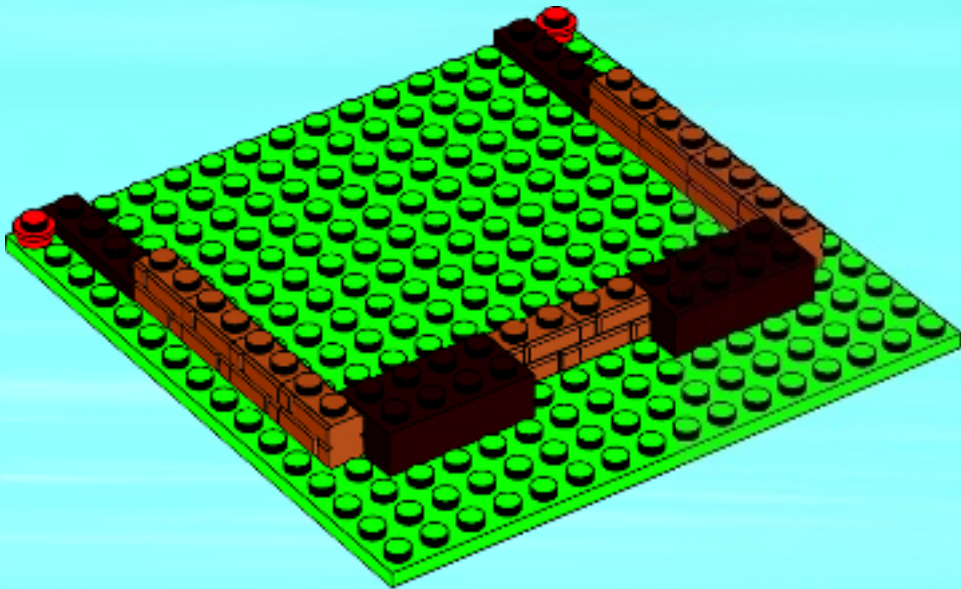



1x



1x

5

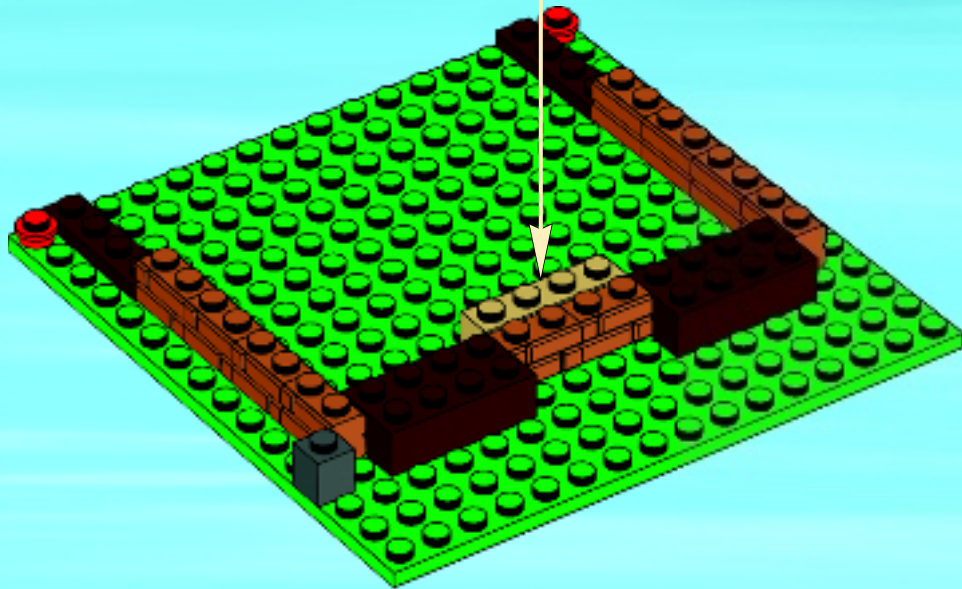
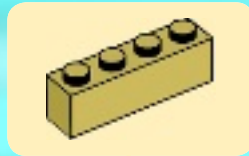



3x

2x



3x



2x

6

1

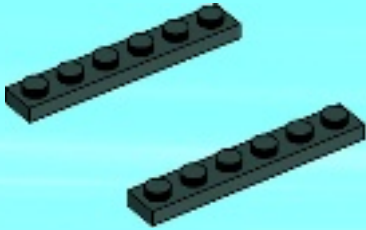

2

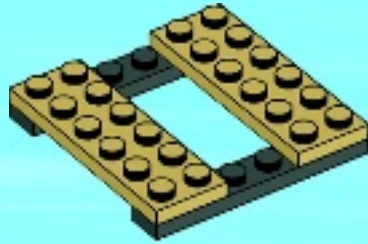

3

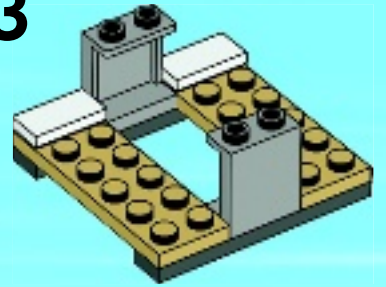

4

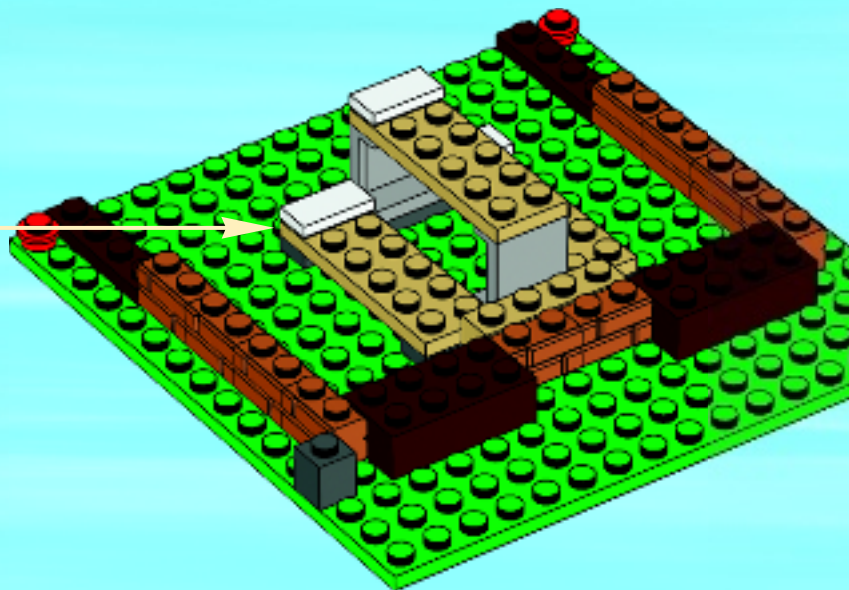
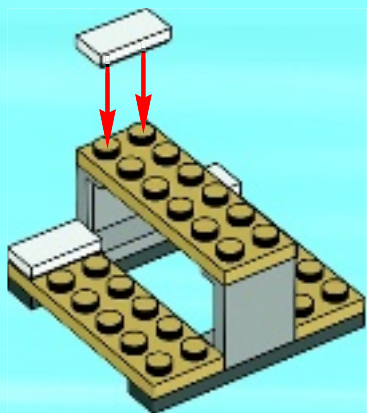



2x



2x

7

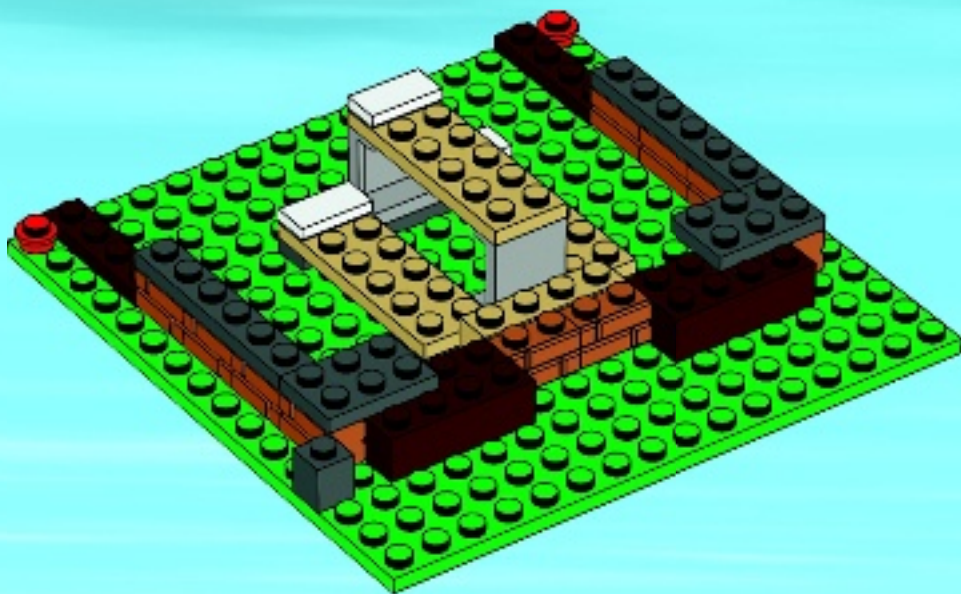



1x

8

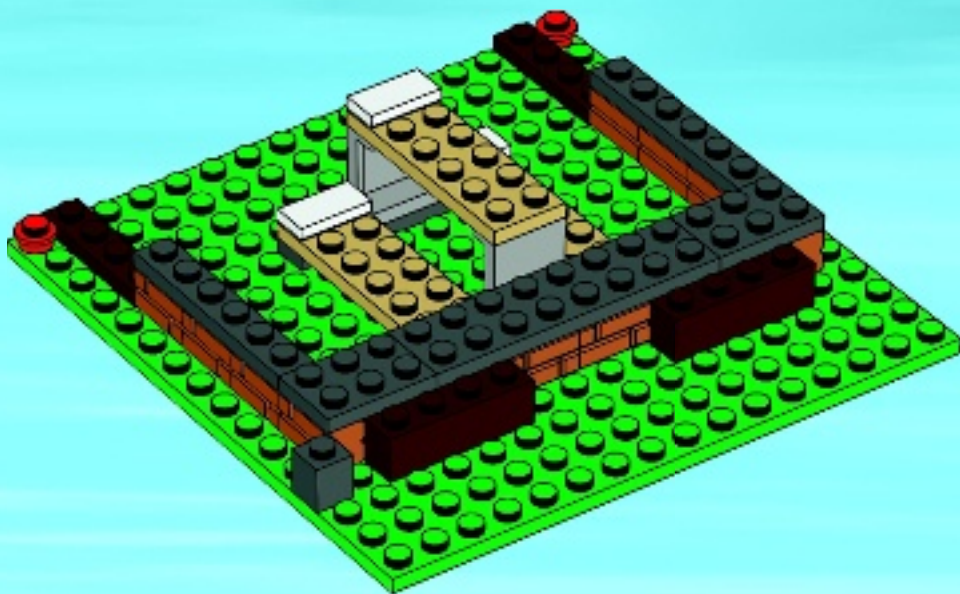

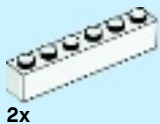

2x



2x

9

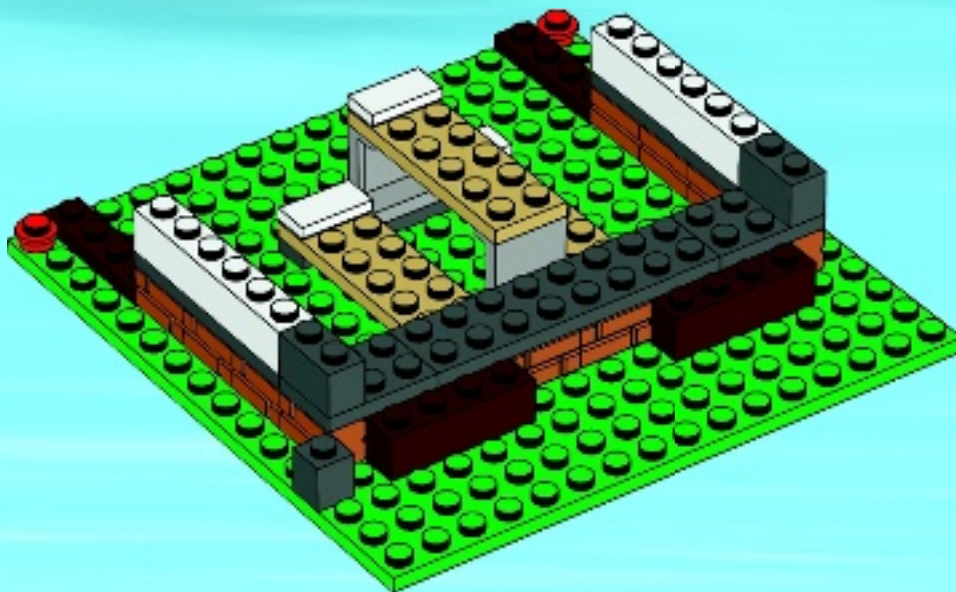



2x



2x



2x



12x



4x

10

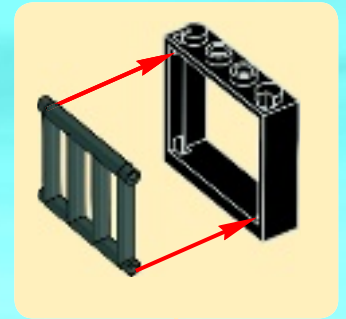
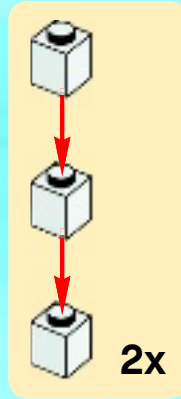

1

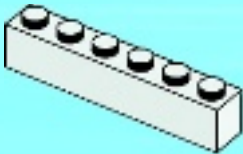

2

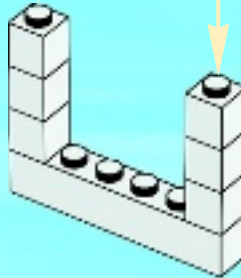

3

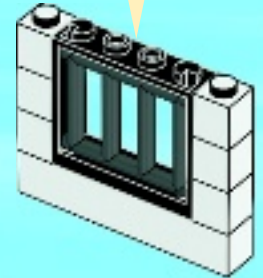

4

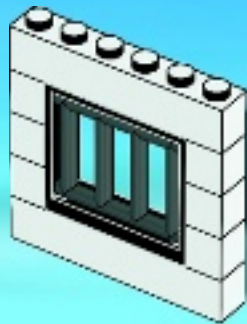

2x

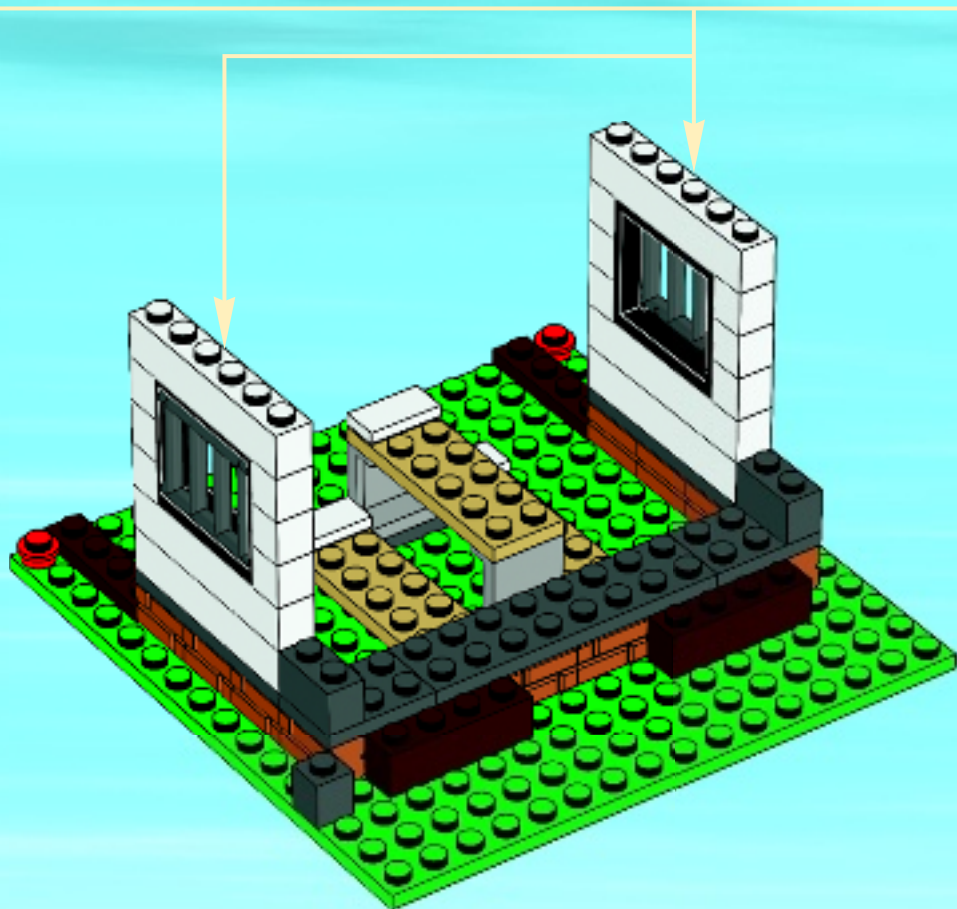



2x

11

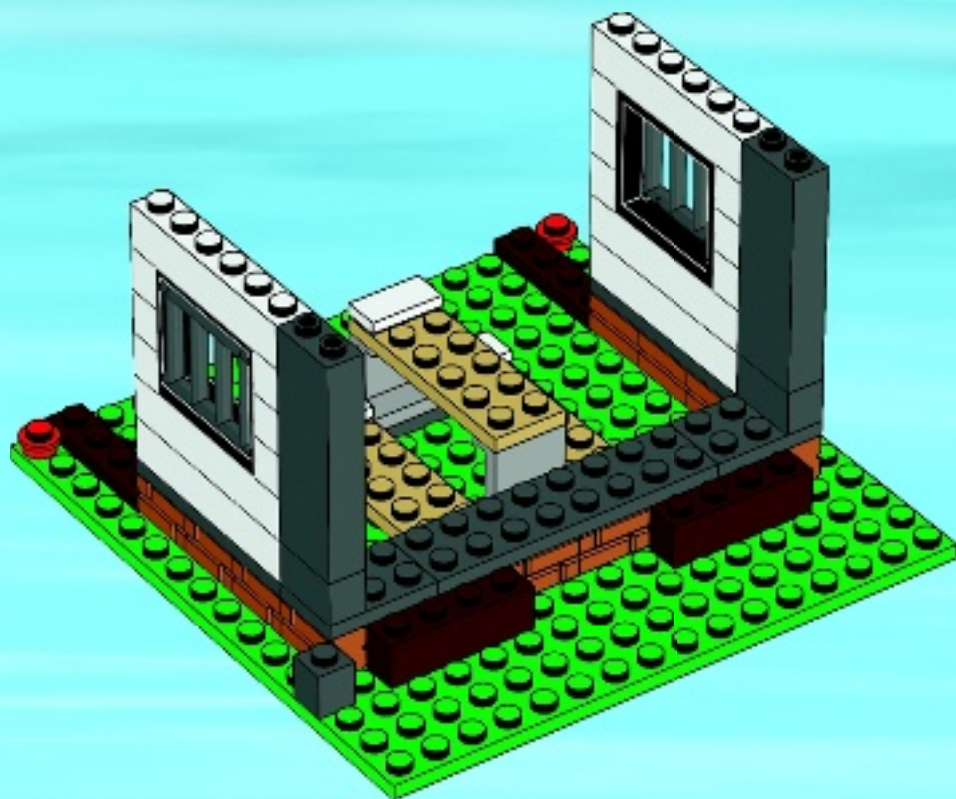

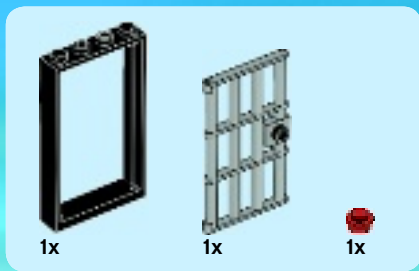

12

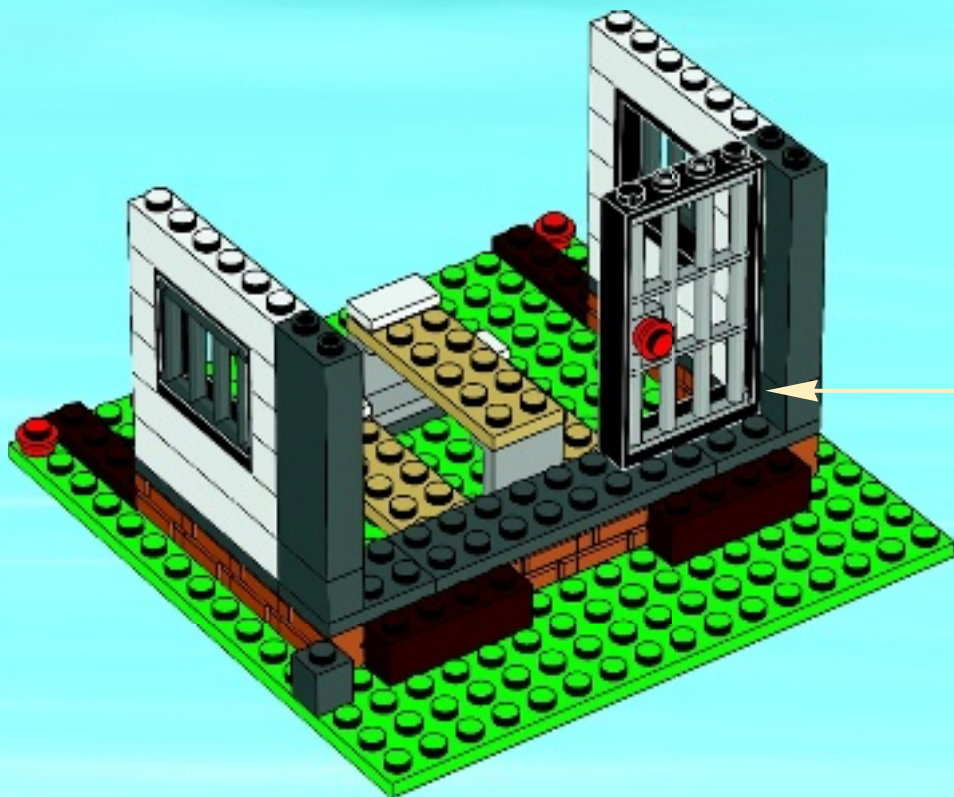
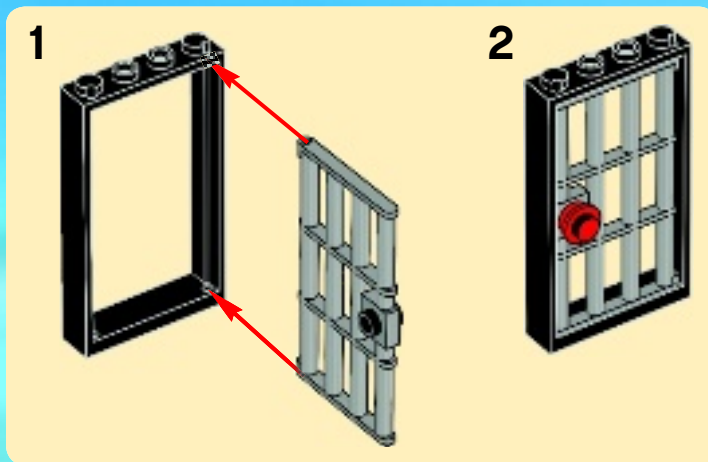

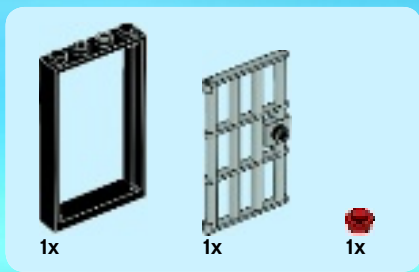

13

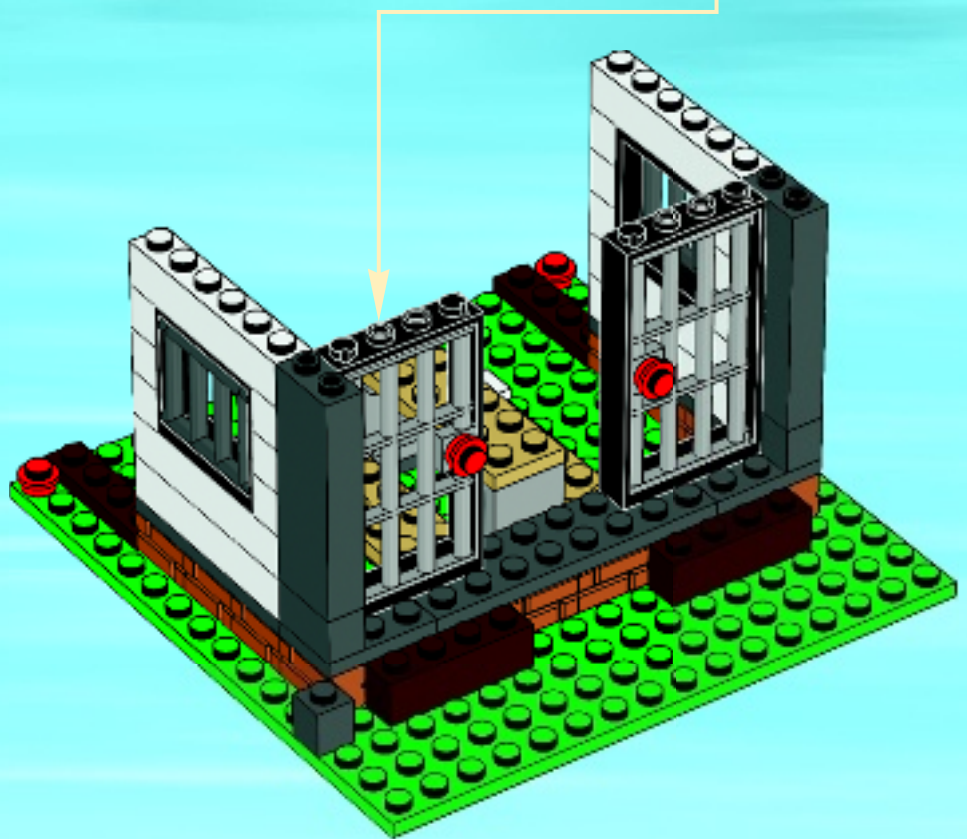
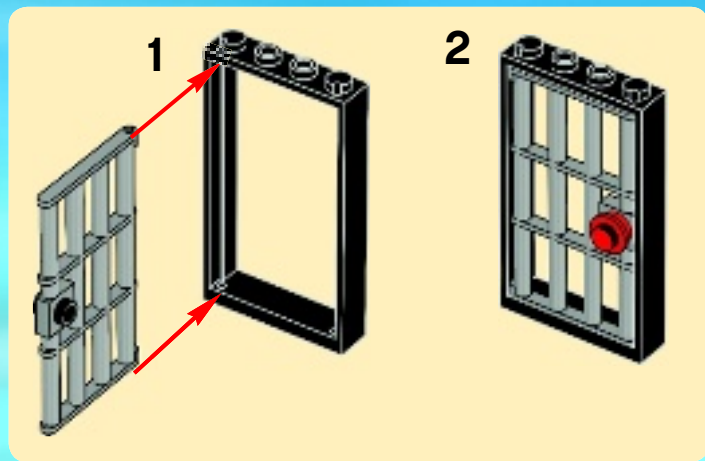

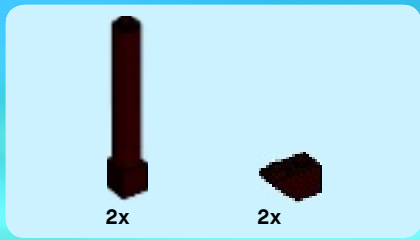

14

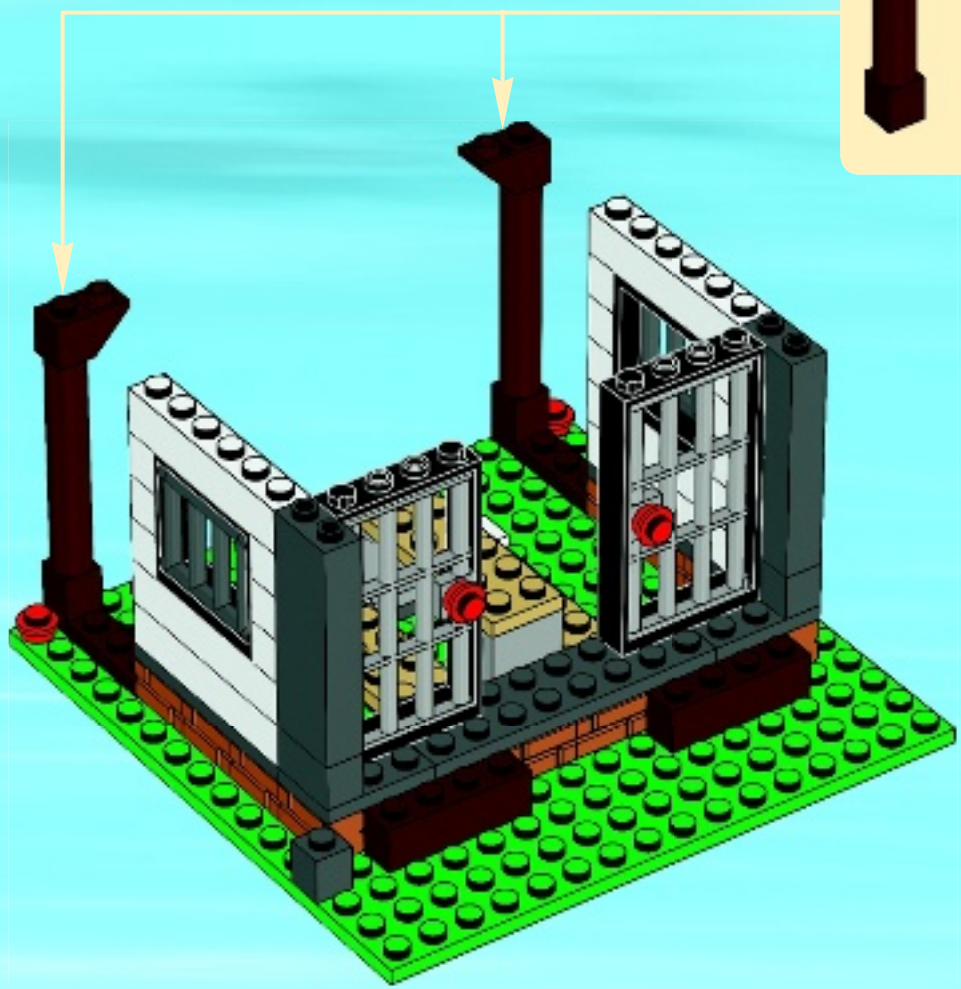
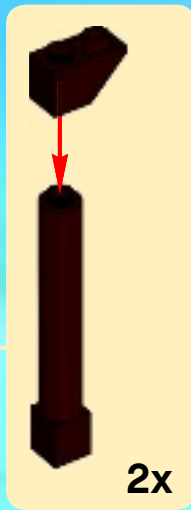

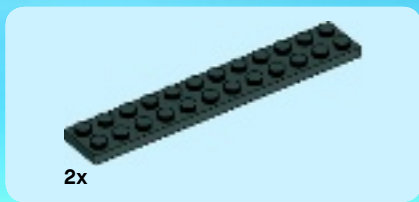

15

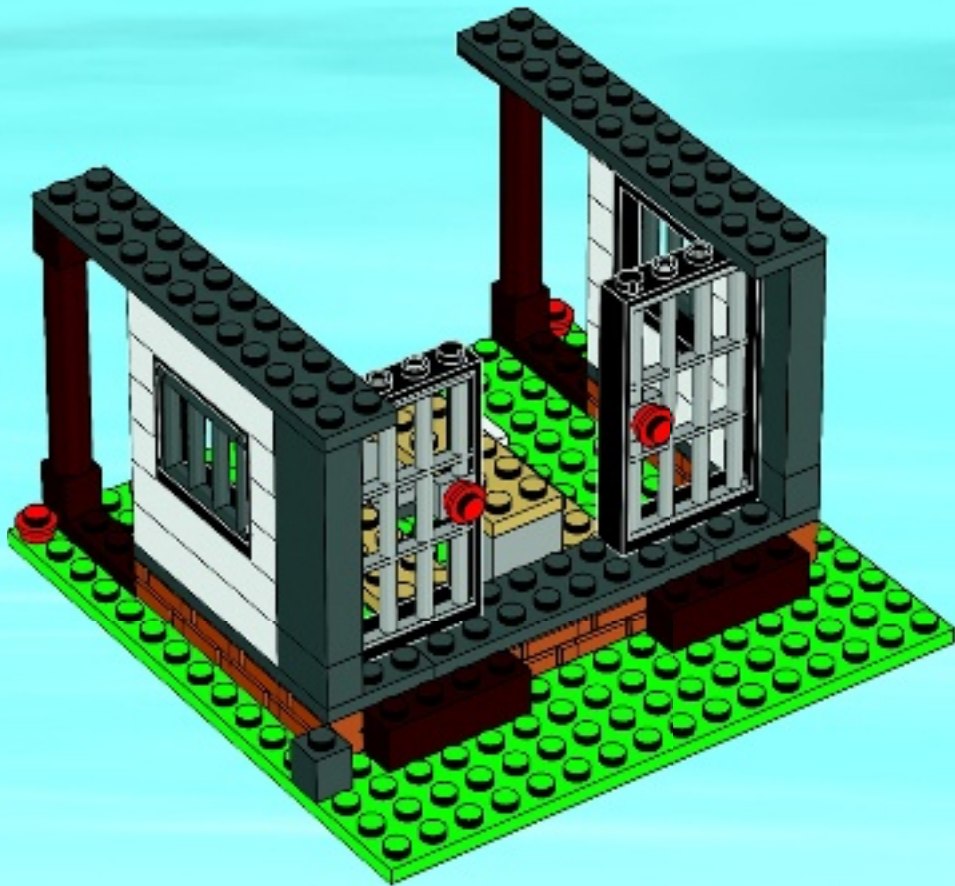

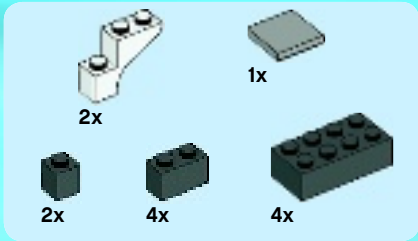

16

1

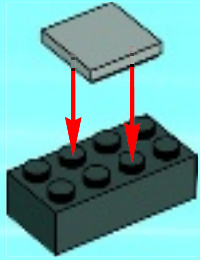

2

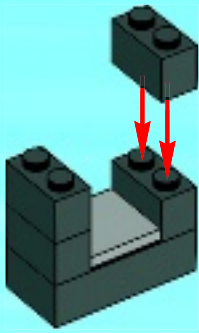

3

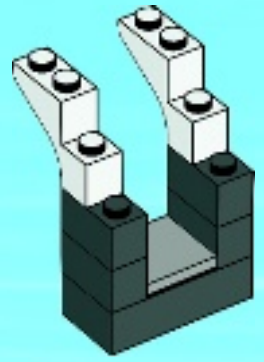

4

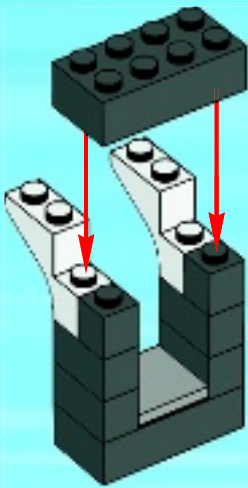

5

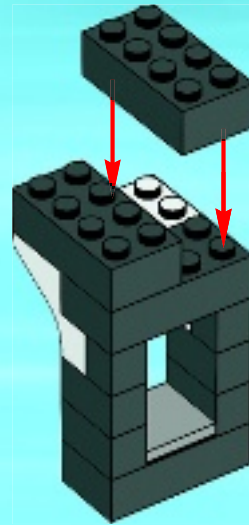

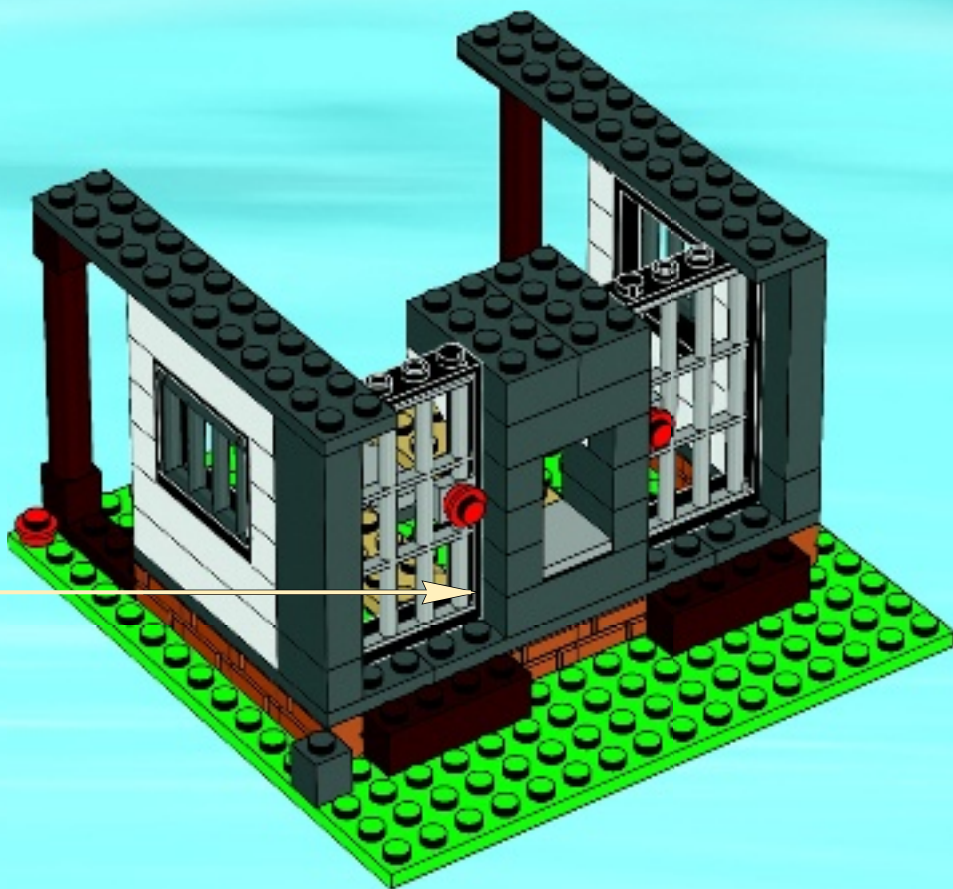



1x

17

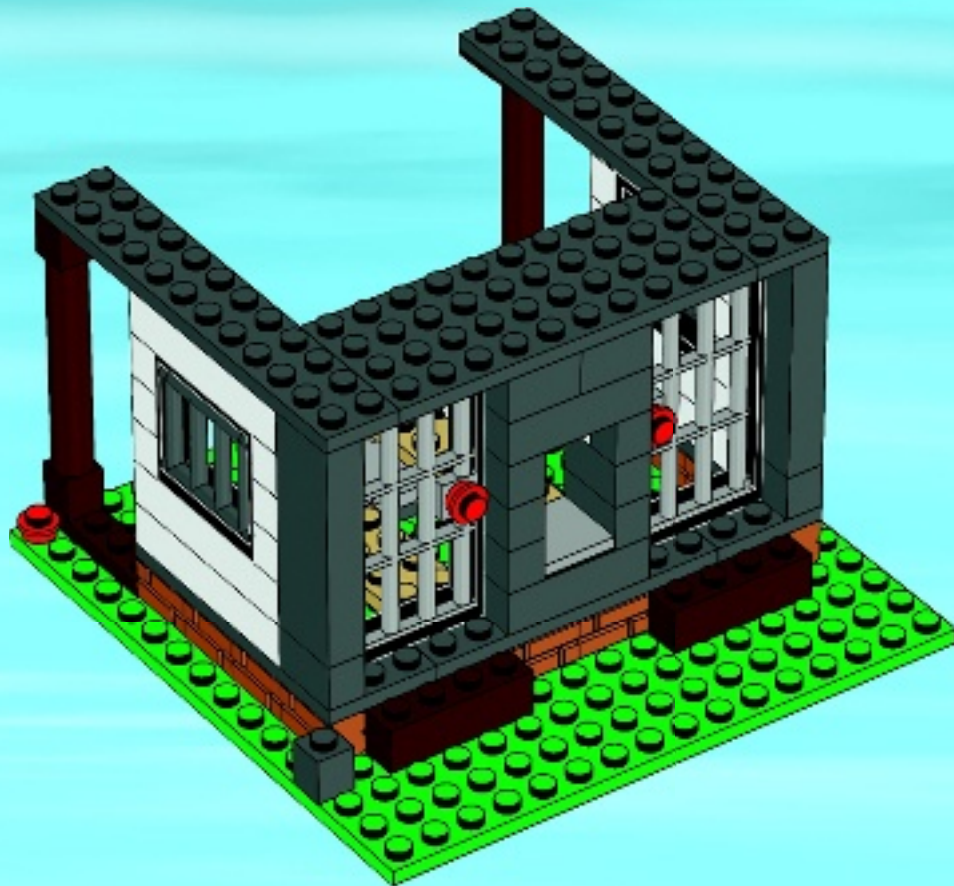

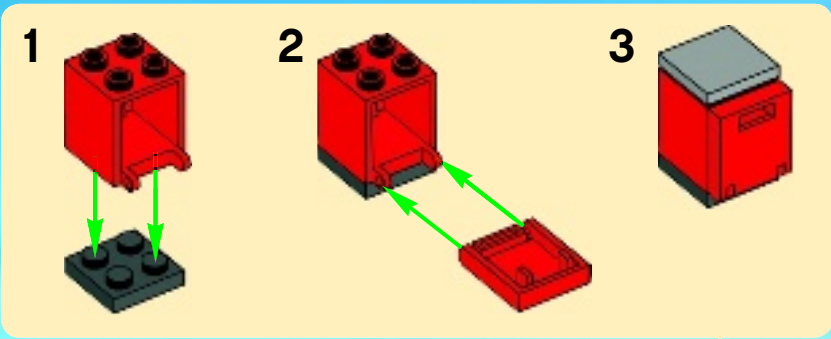
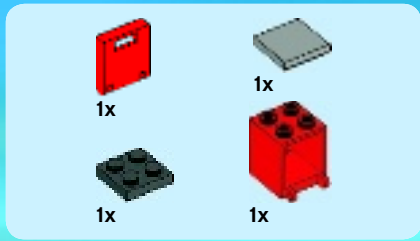

18

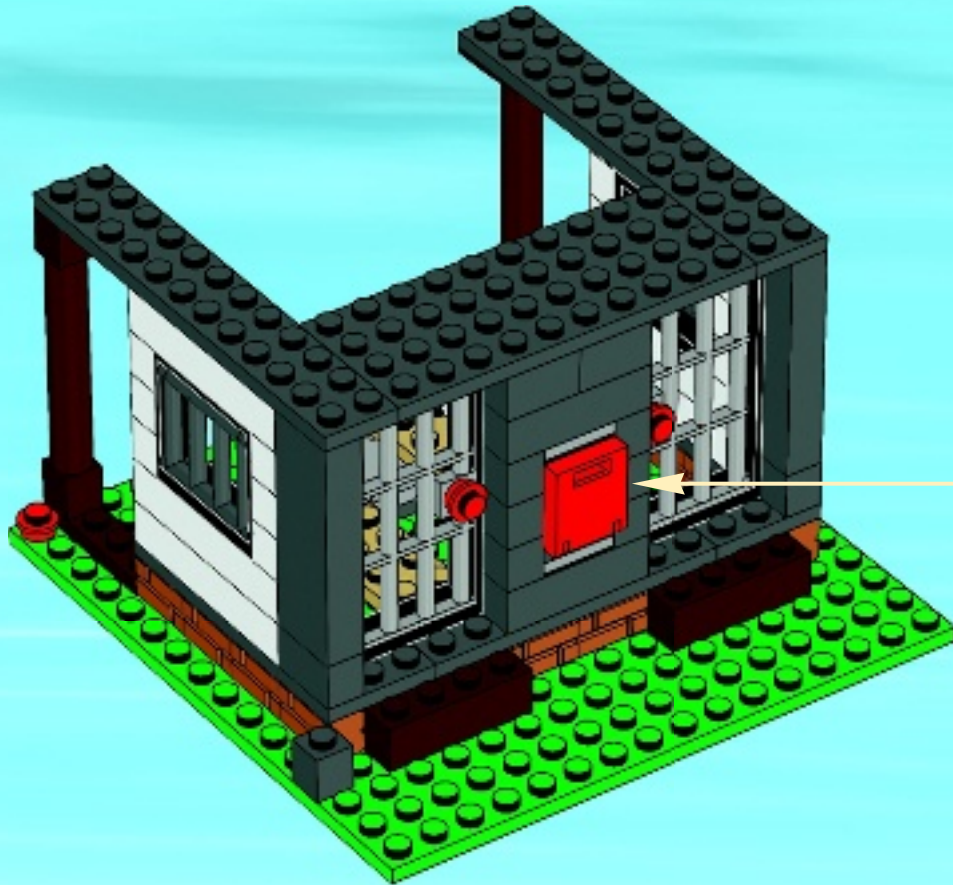

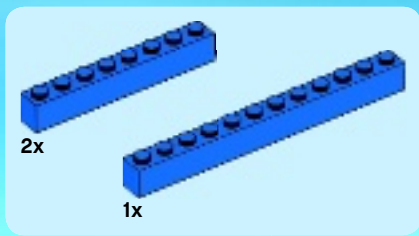

19

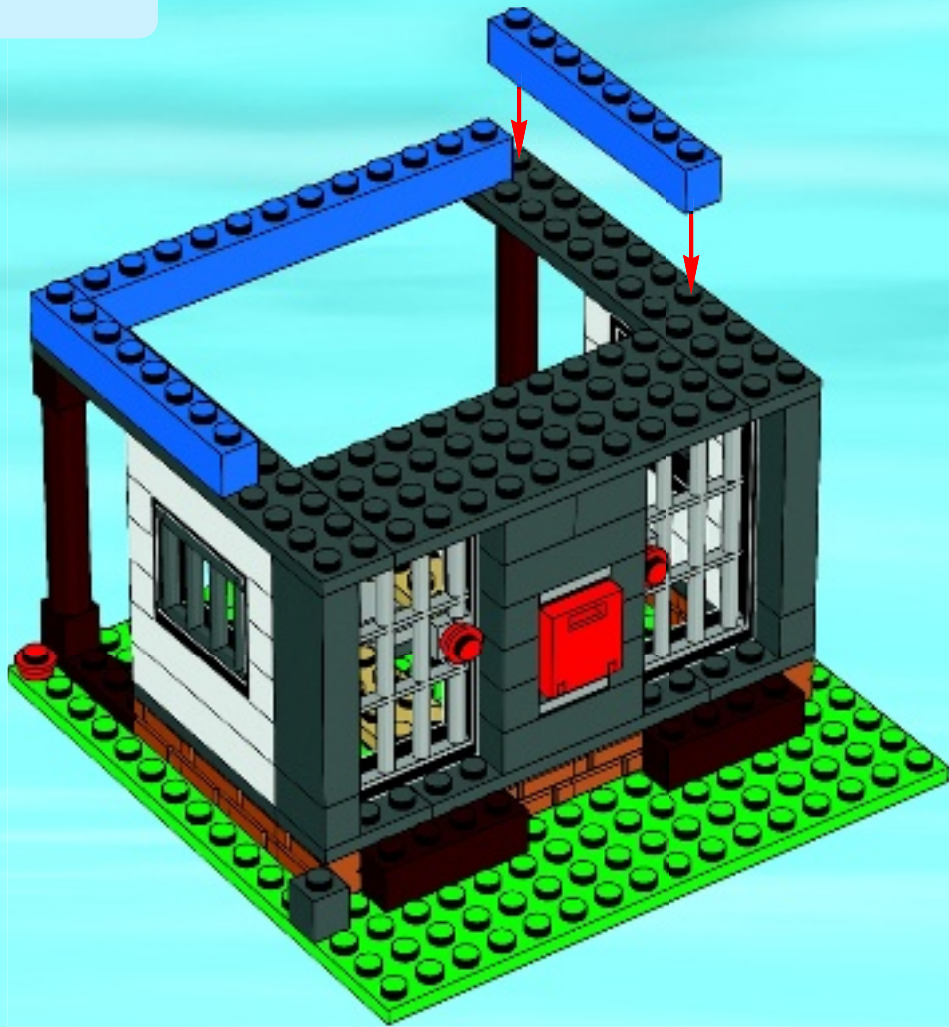



1x



2x

20

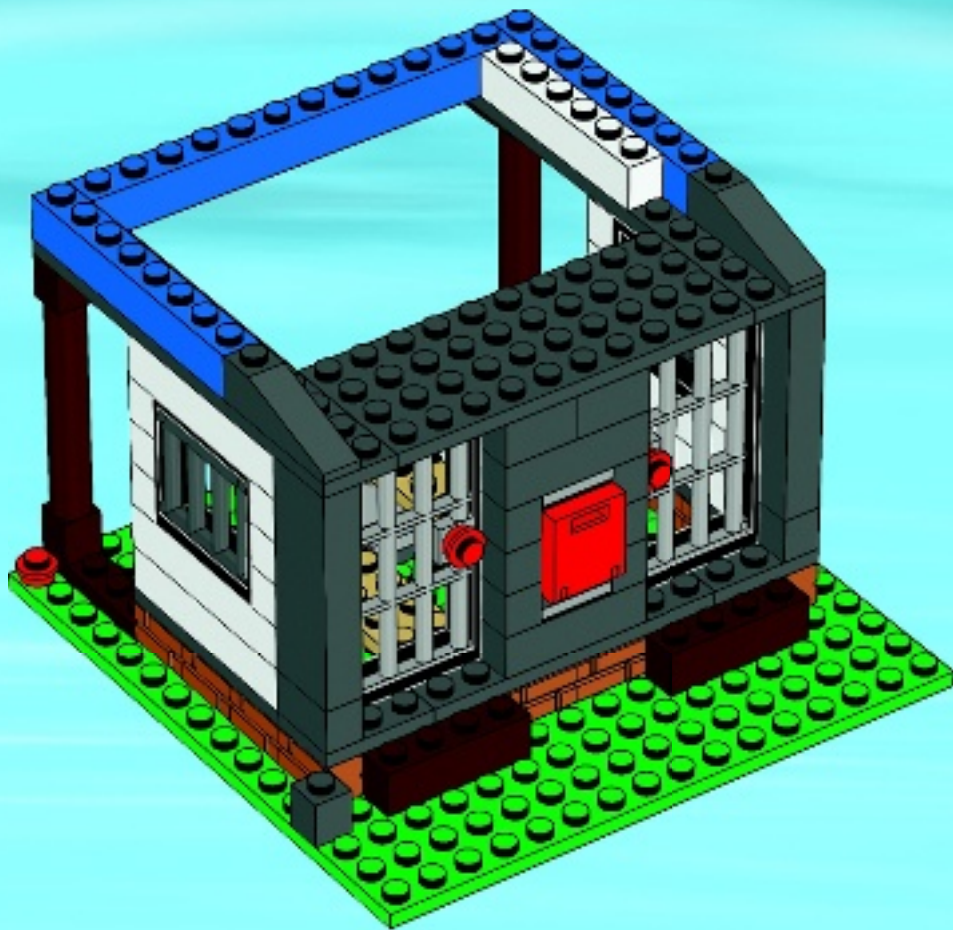

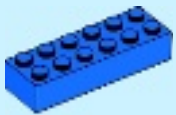

1x



1x

21

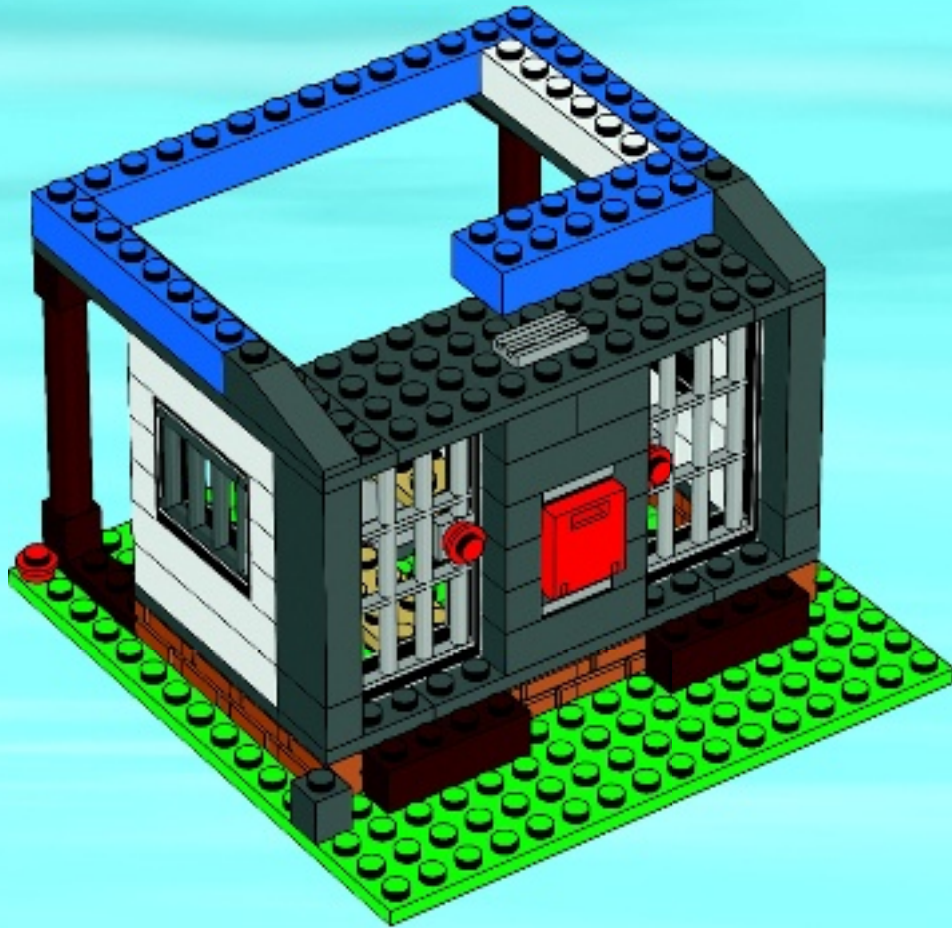

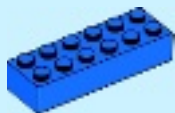

1x

22

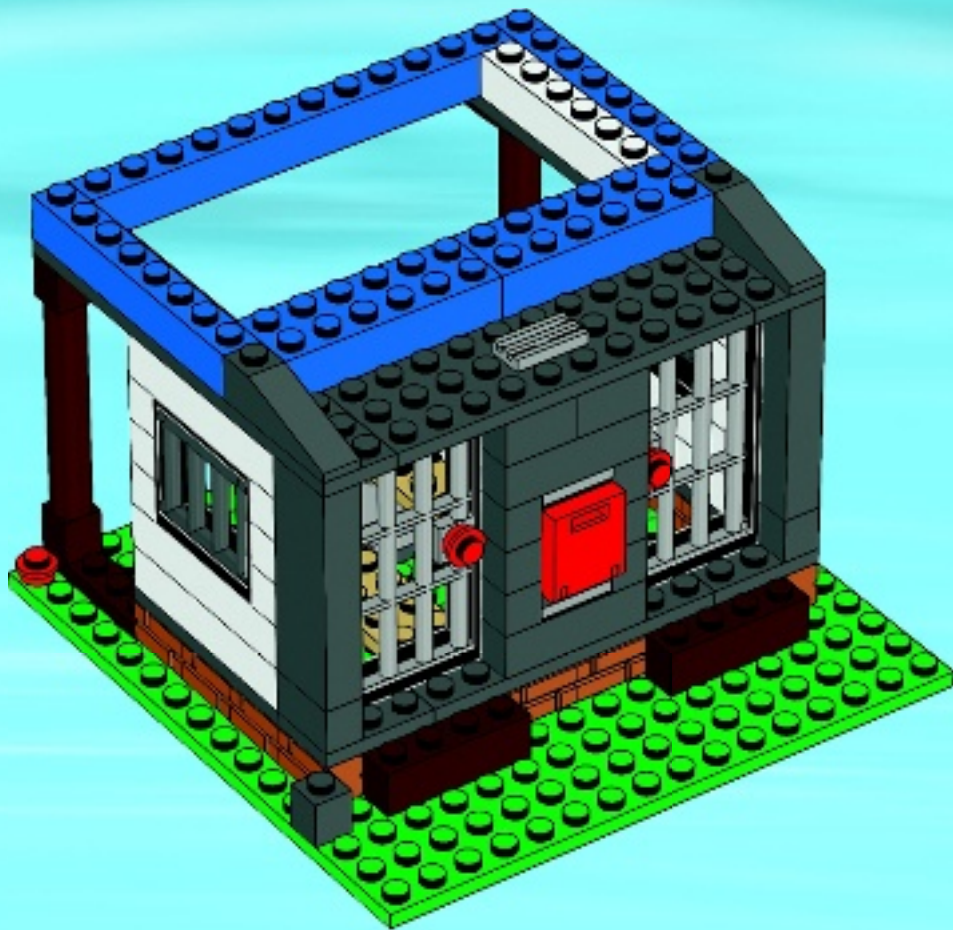



1x



1x

23

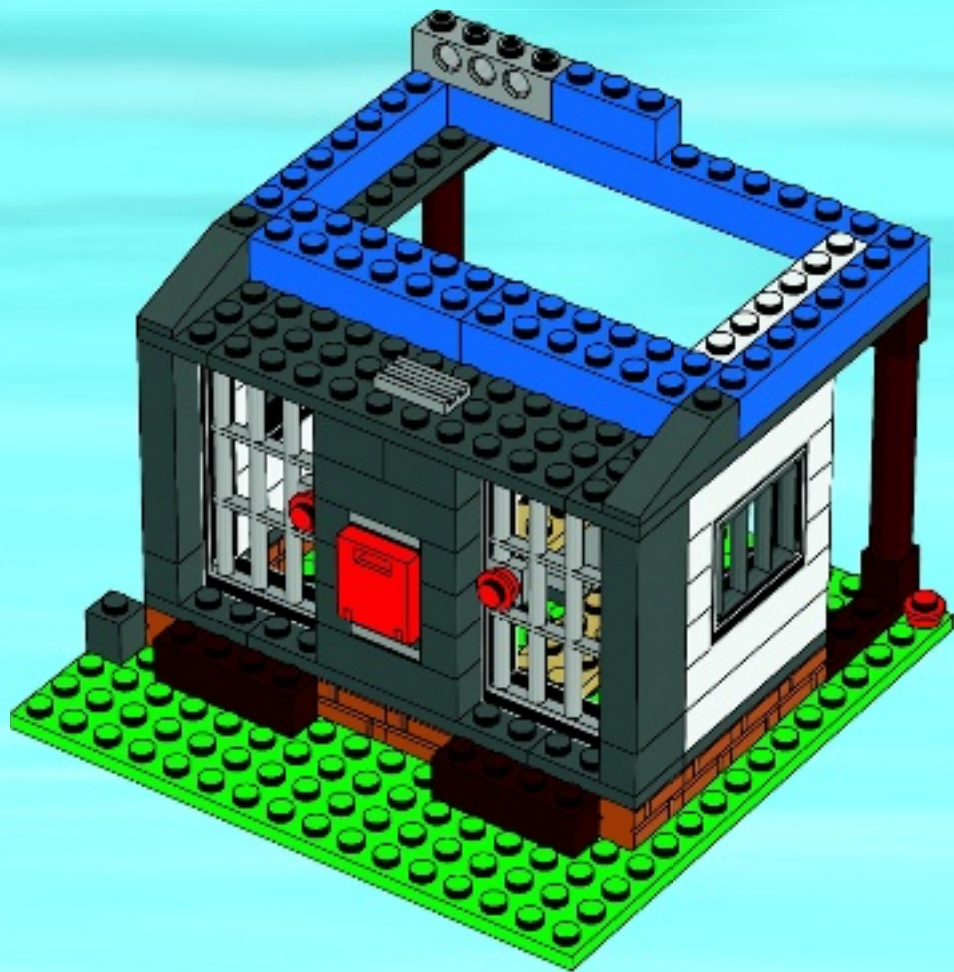



1x



1x

24

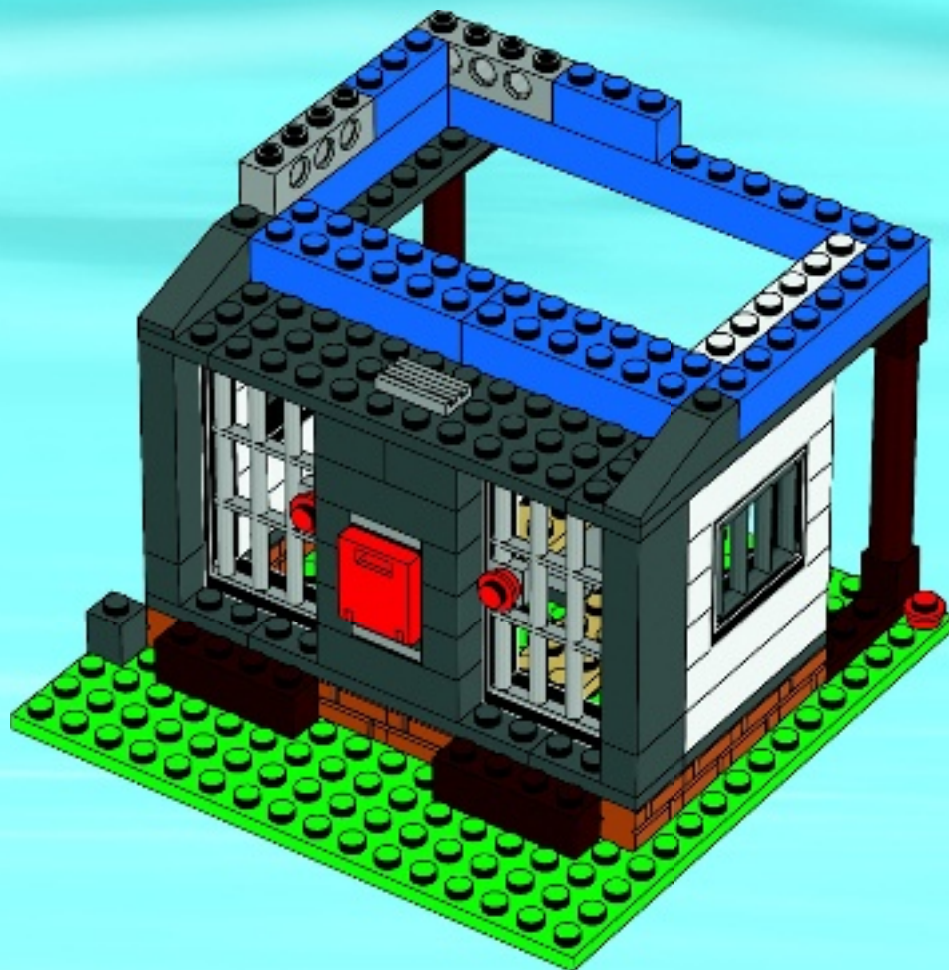



2x

25

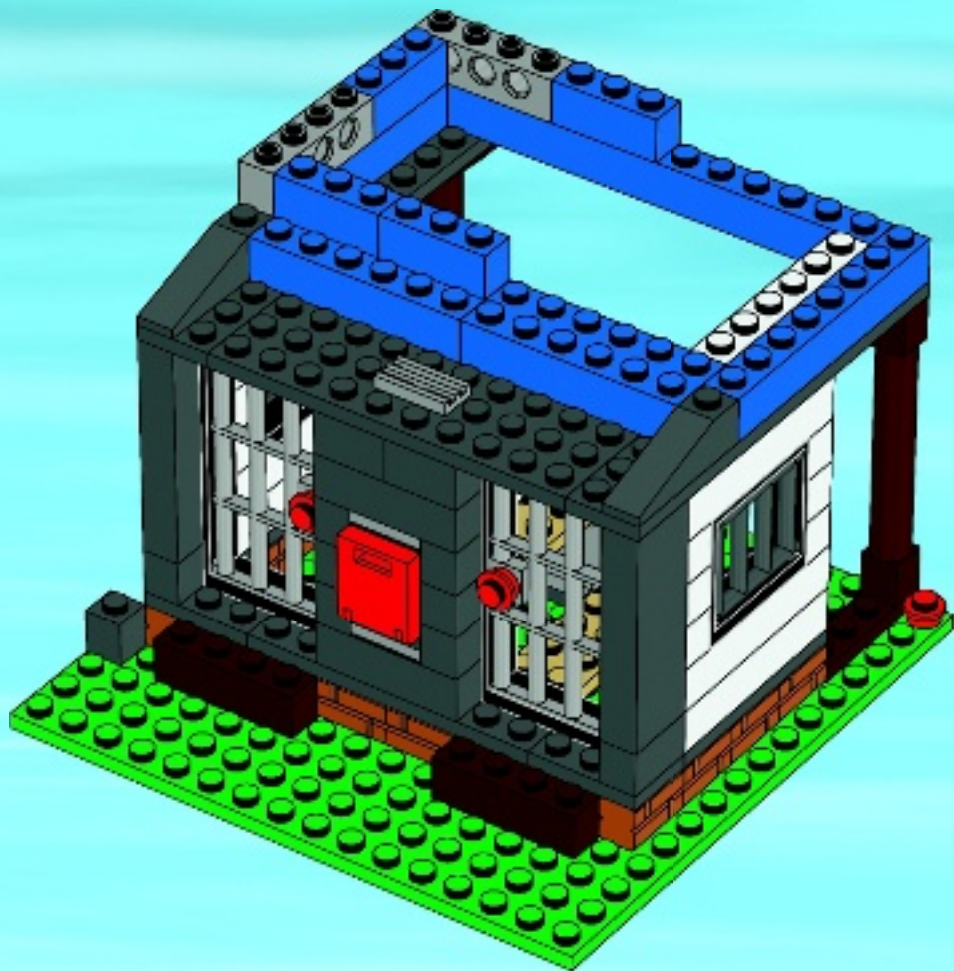

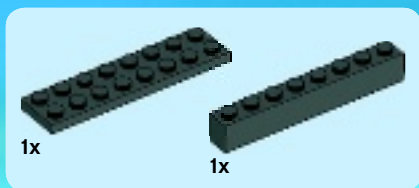

26

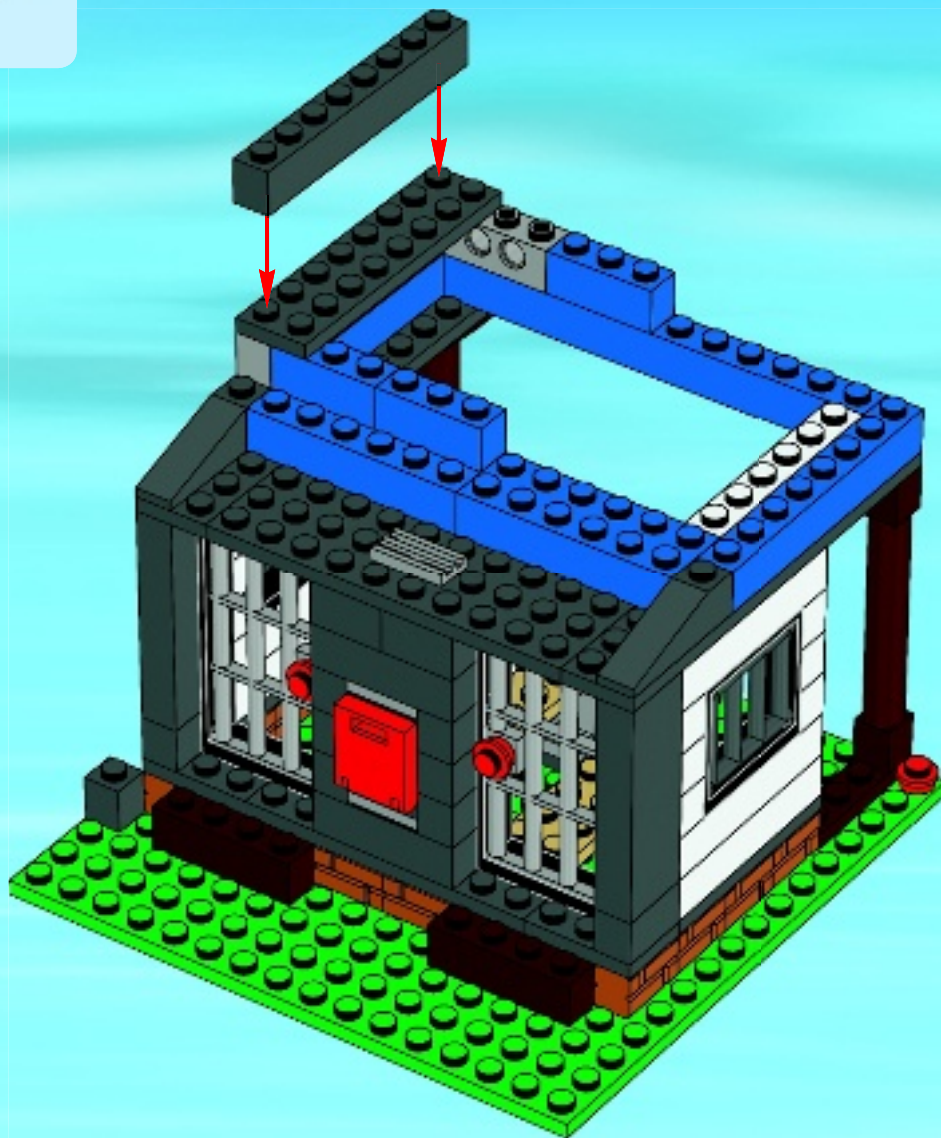



4x

27

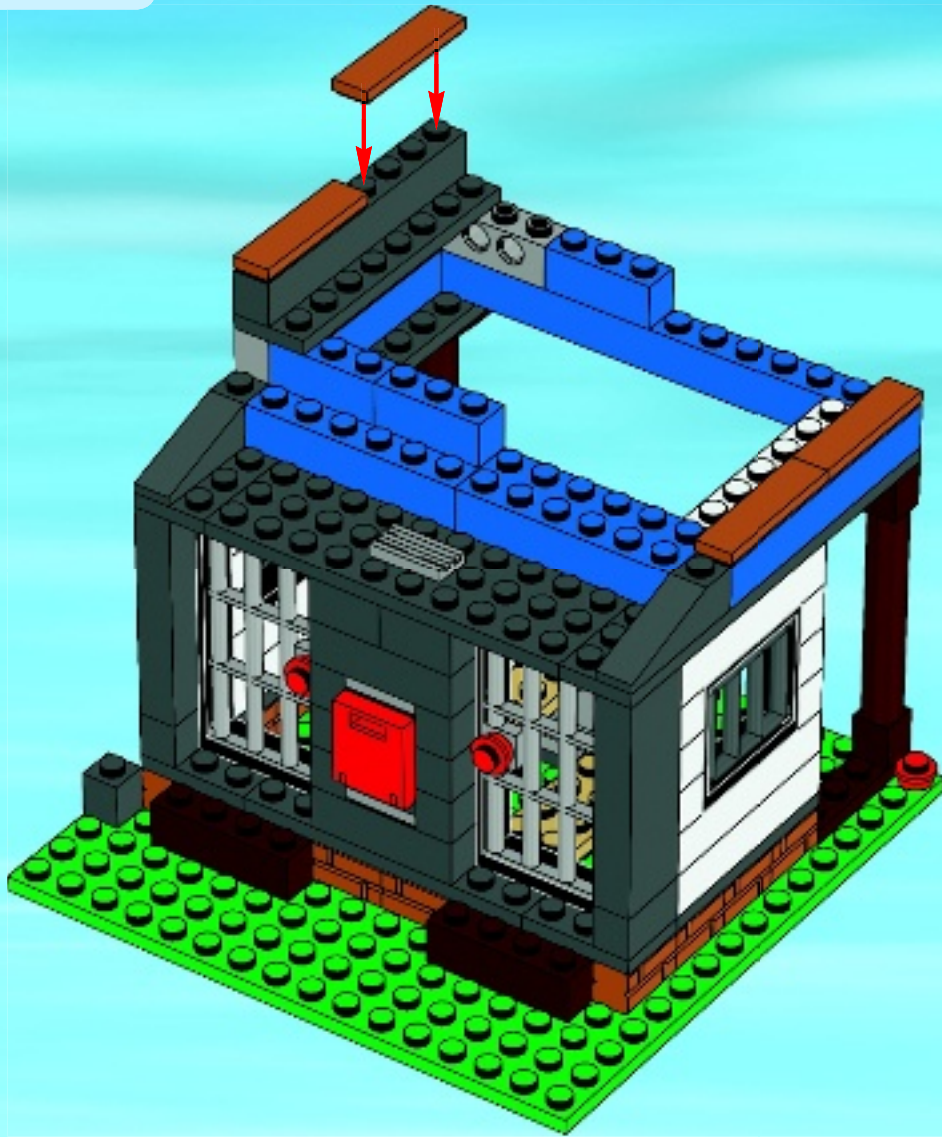

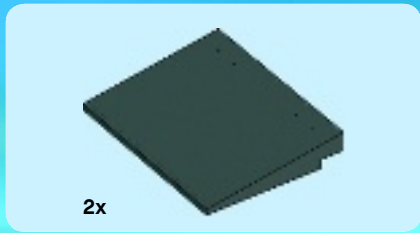

28

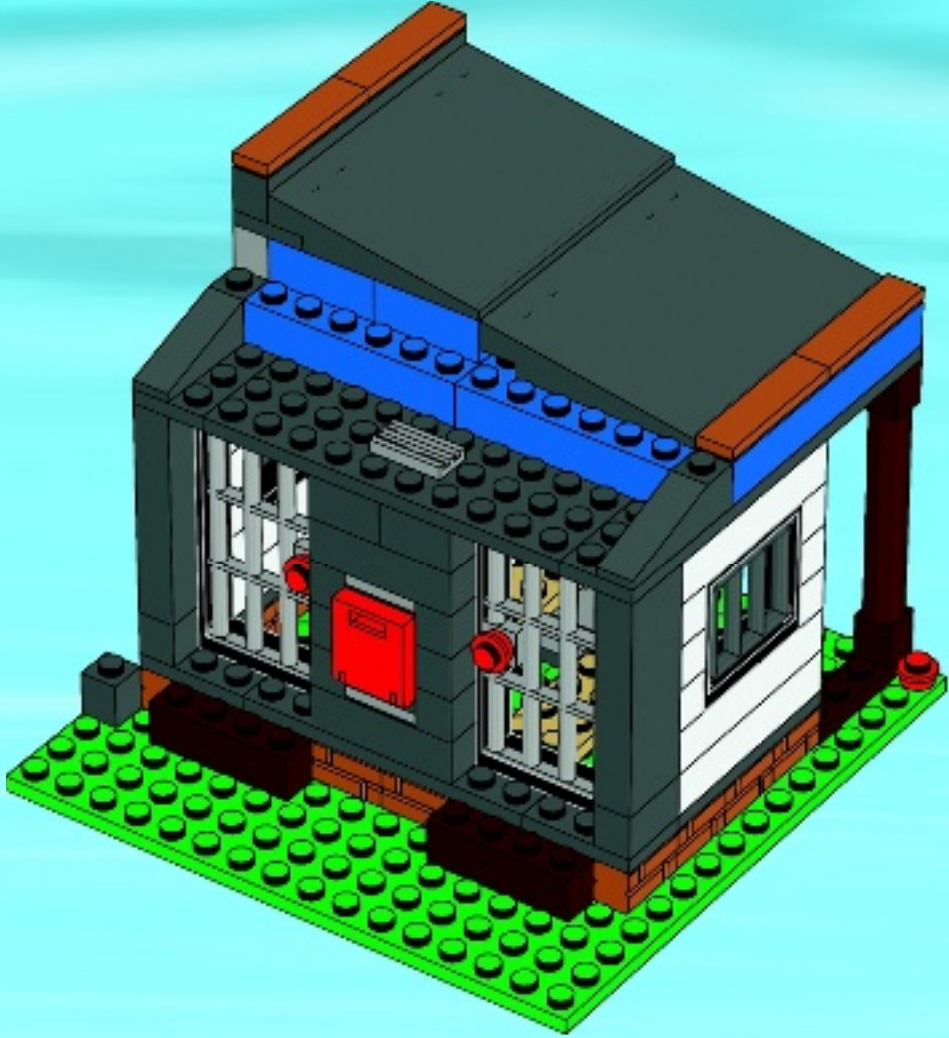



2x



3x

29





3x



3x

30

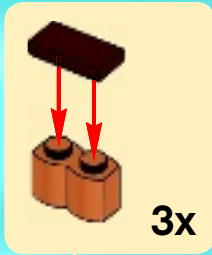

3x





31

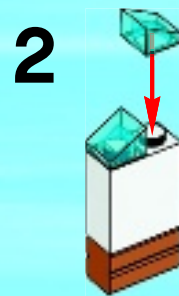
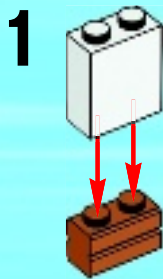

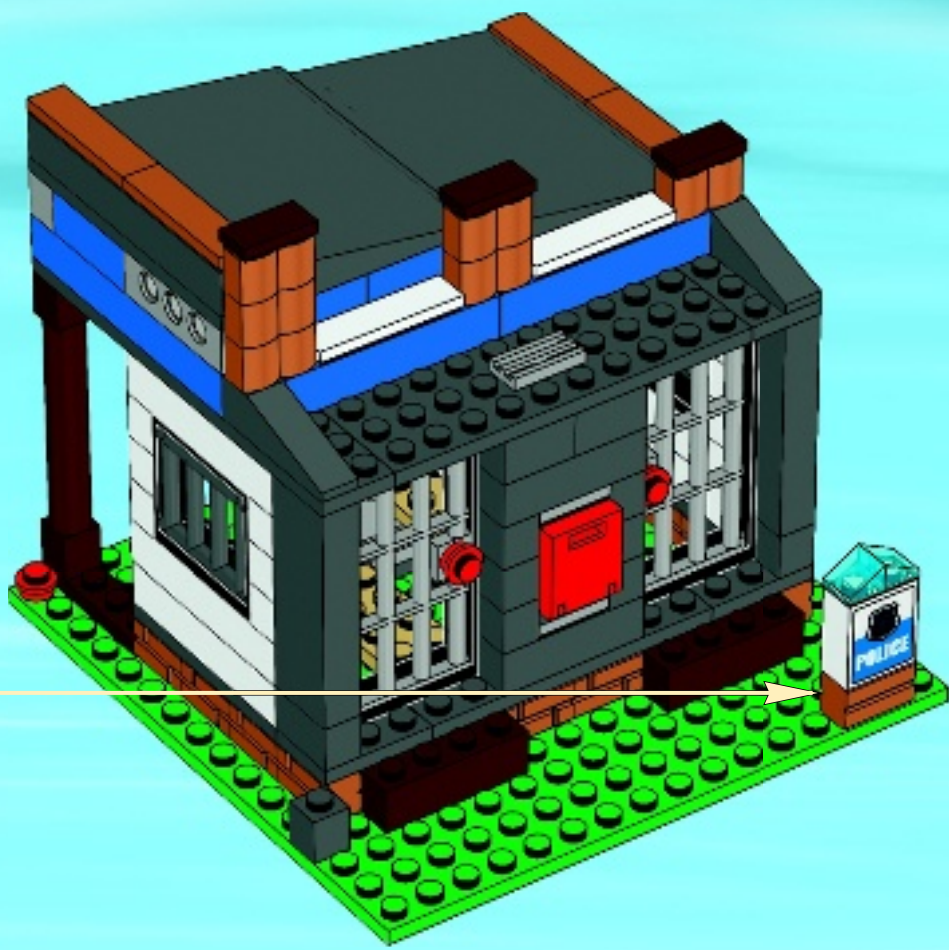



1x



1x



1x

32

1



2

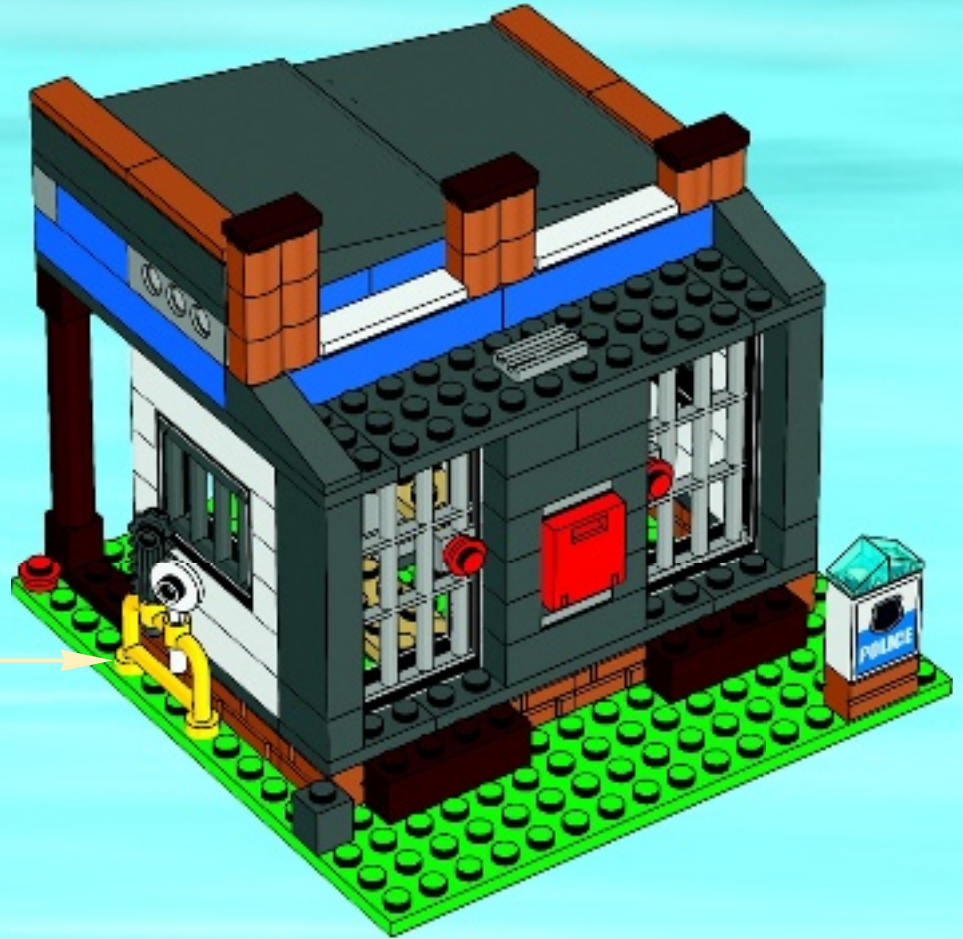

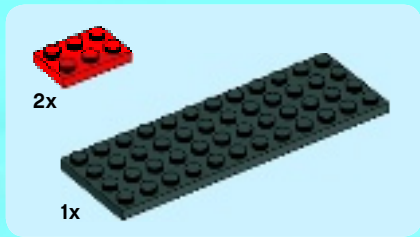
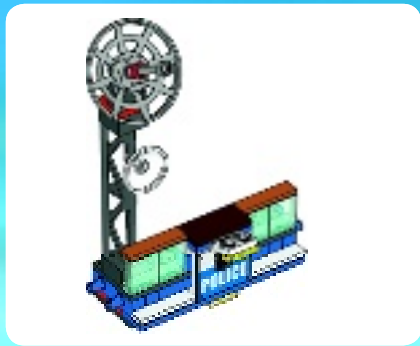

1

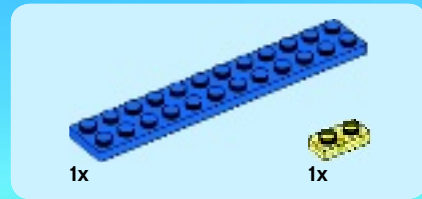
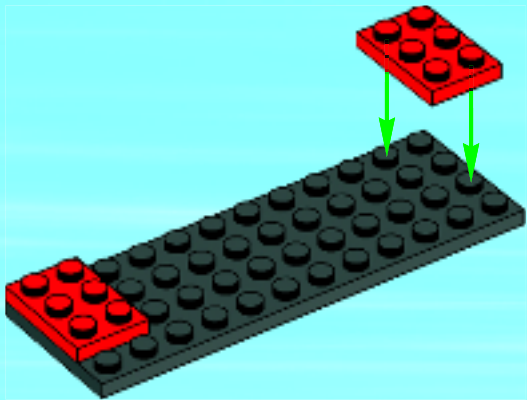

2

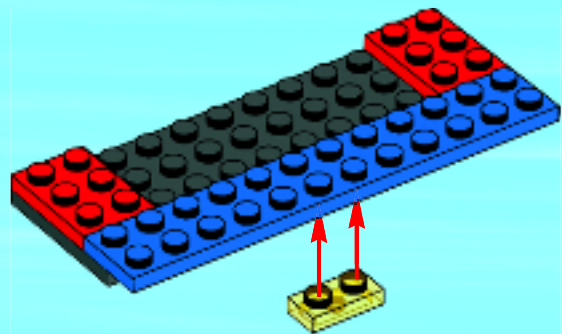



4x

3

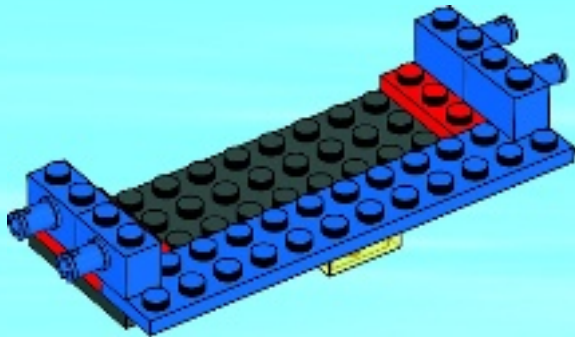

2x

4

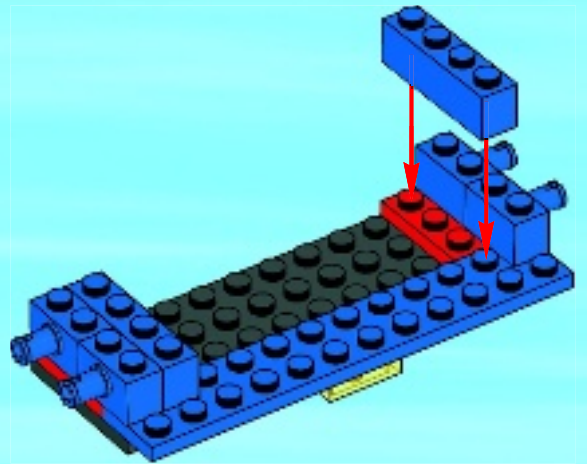



2x

5

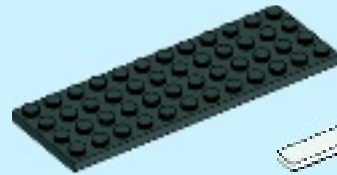
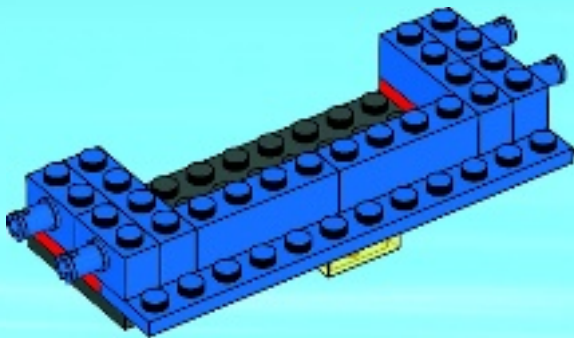

1x

2x

6

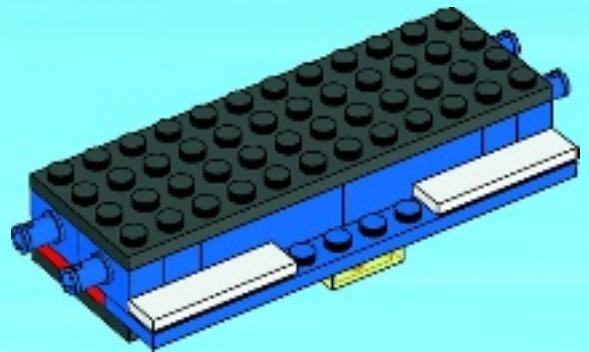



4x



1x

7

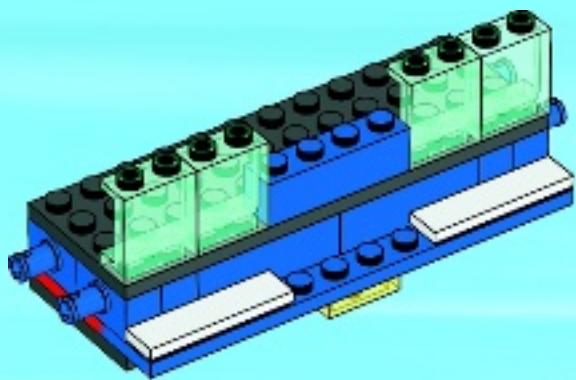

2x



1x

8

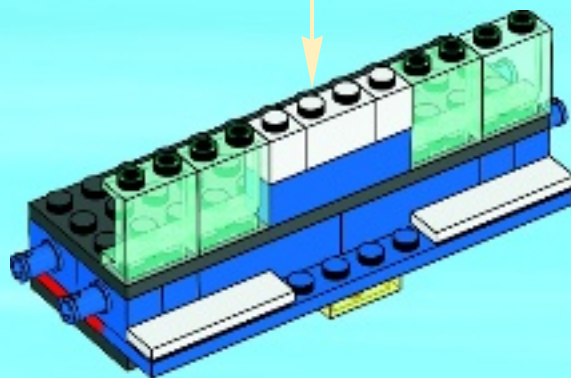

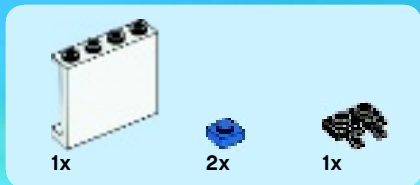

9

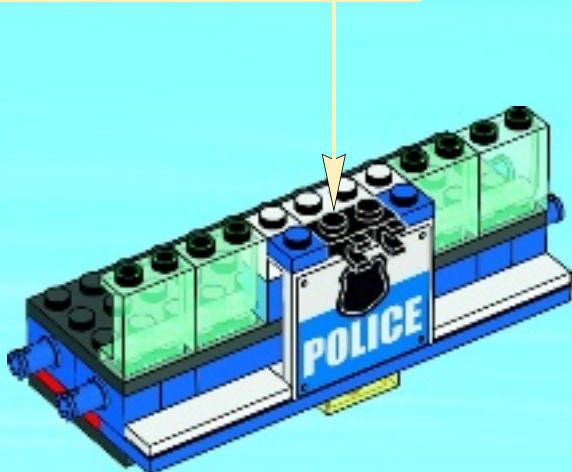
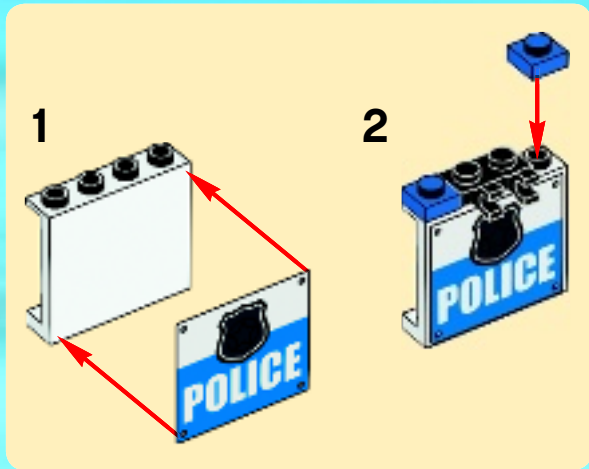



1x



2x

10



1x



1x

11

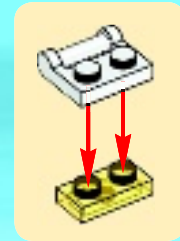

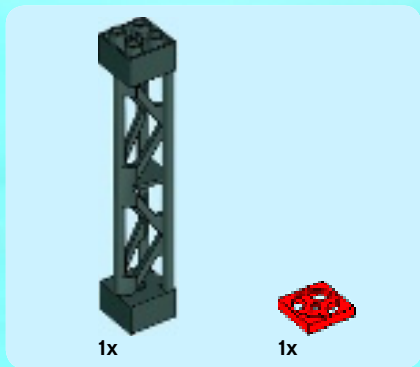

1





1x

2



1x

3



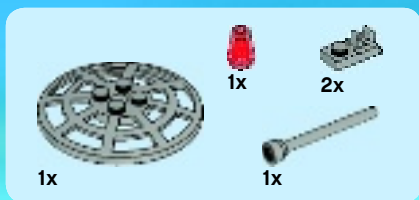

4

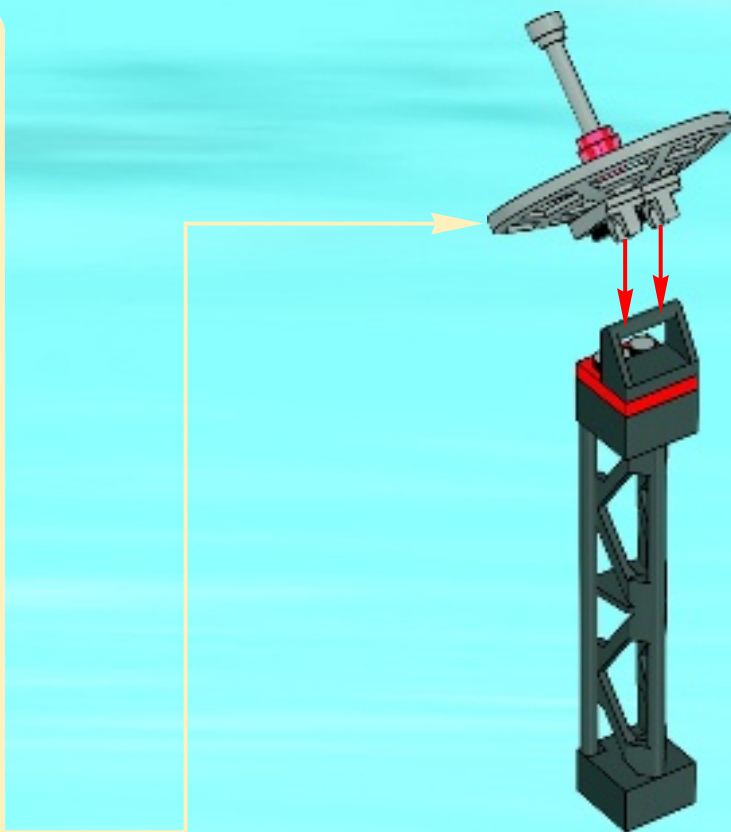
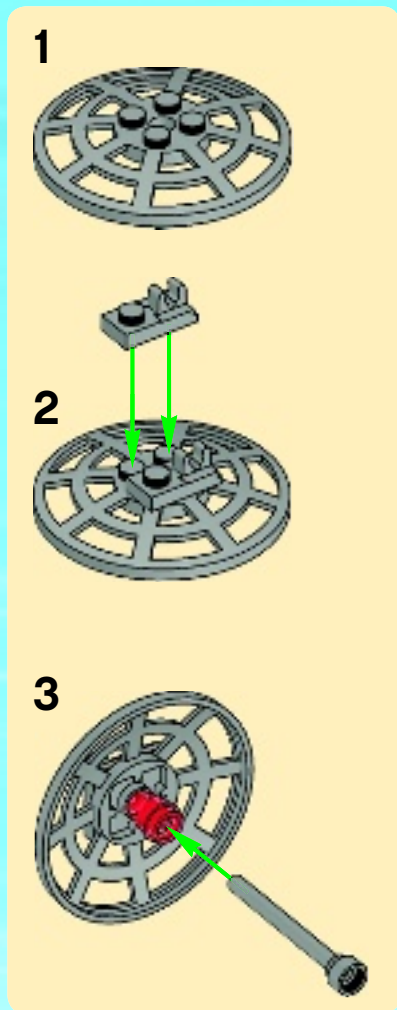



1x



1x

5

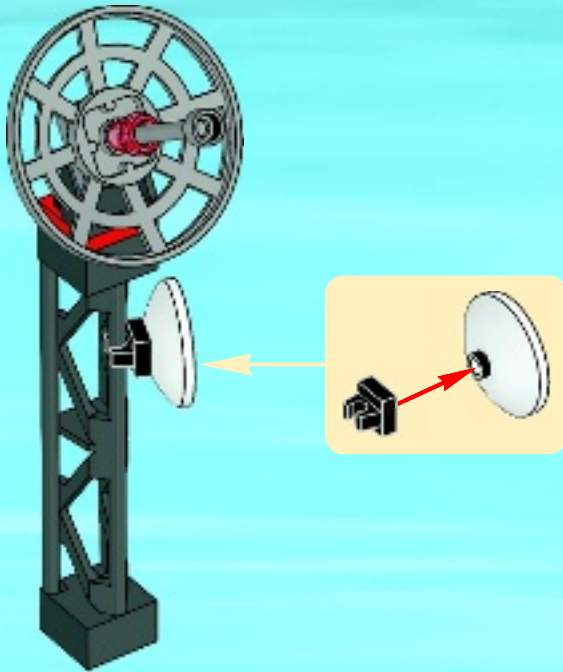

12

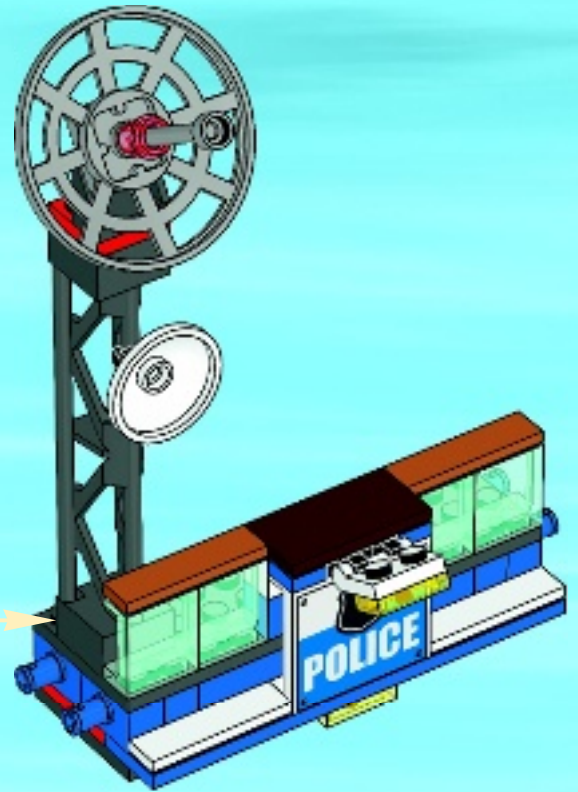

13

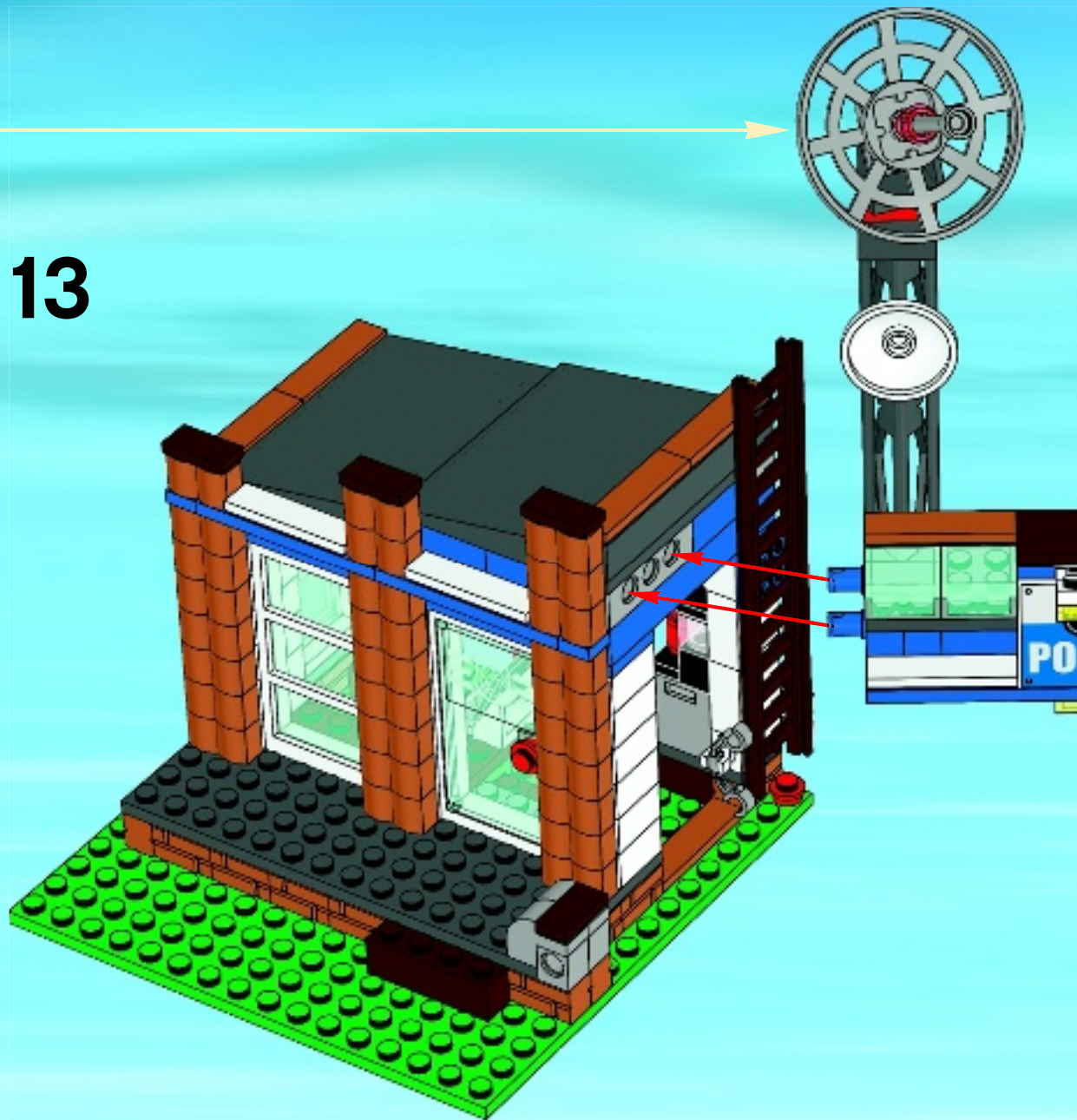

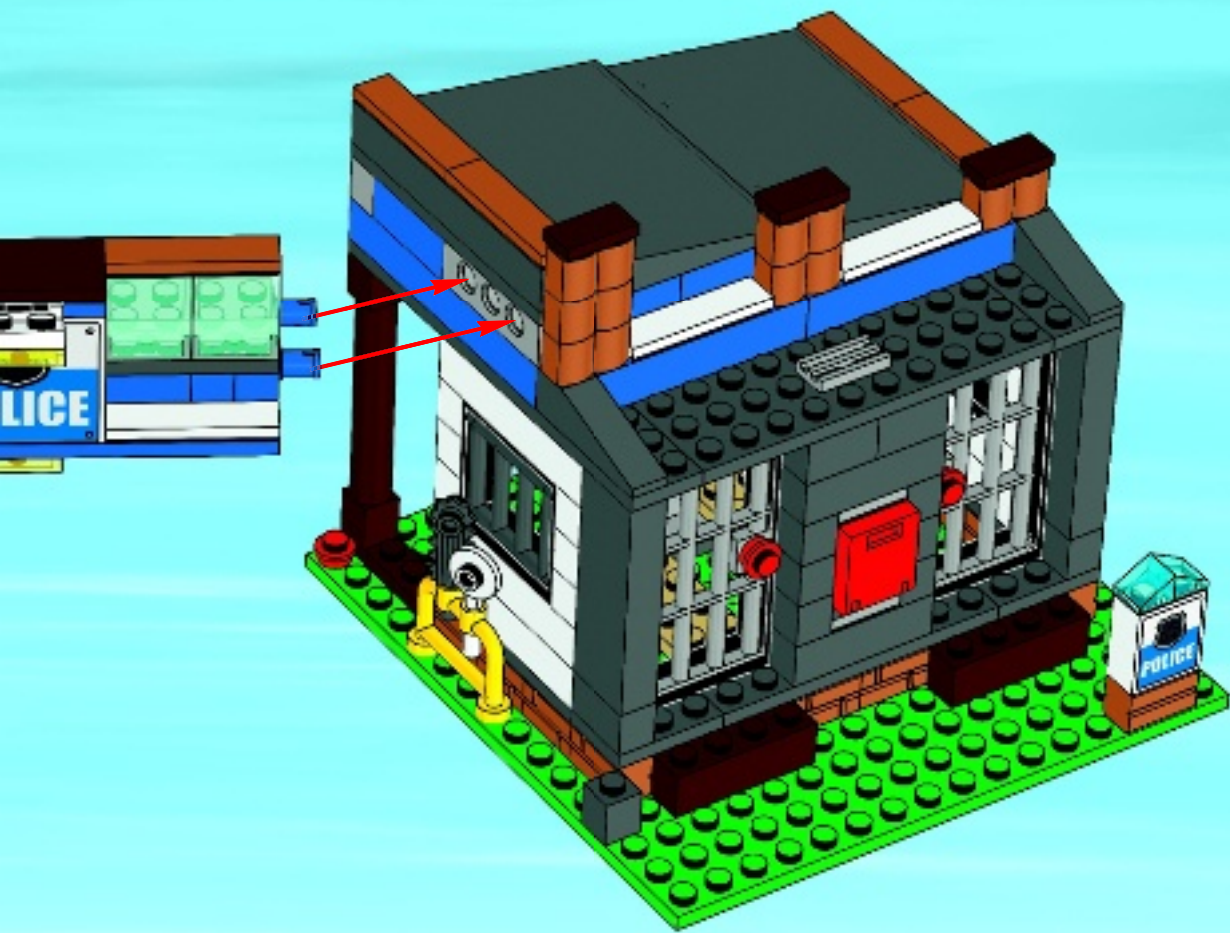

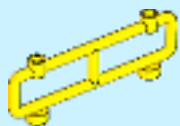

1x

14



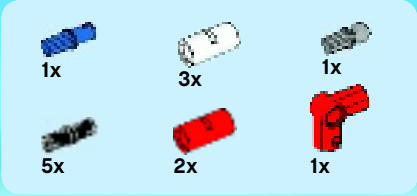
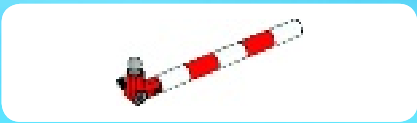

15

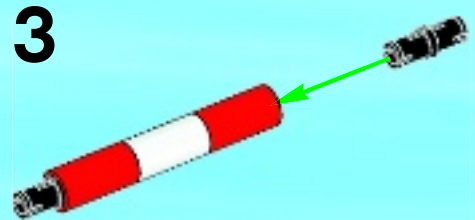
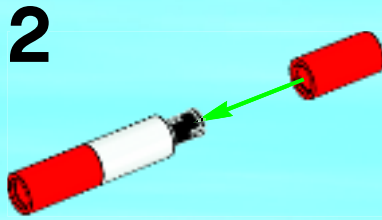
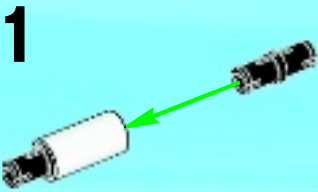

4

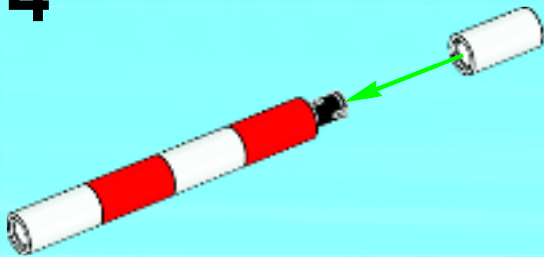

5

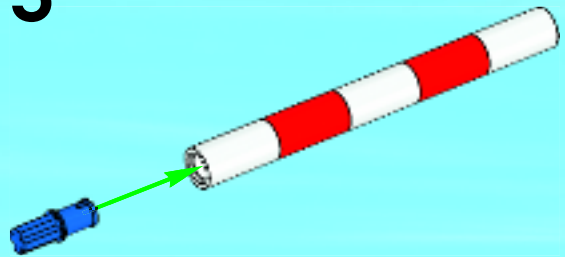

6

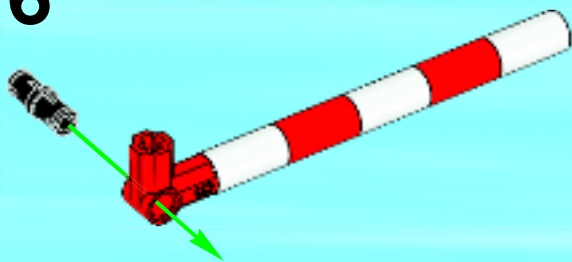

7

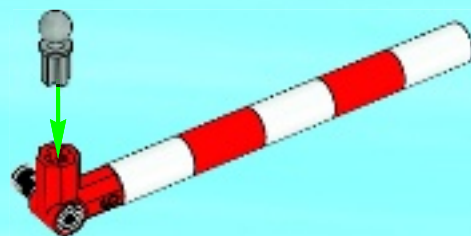

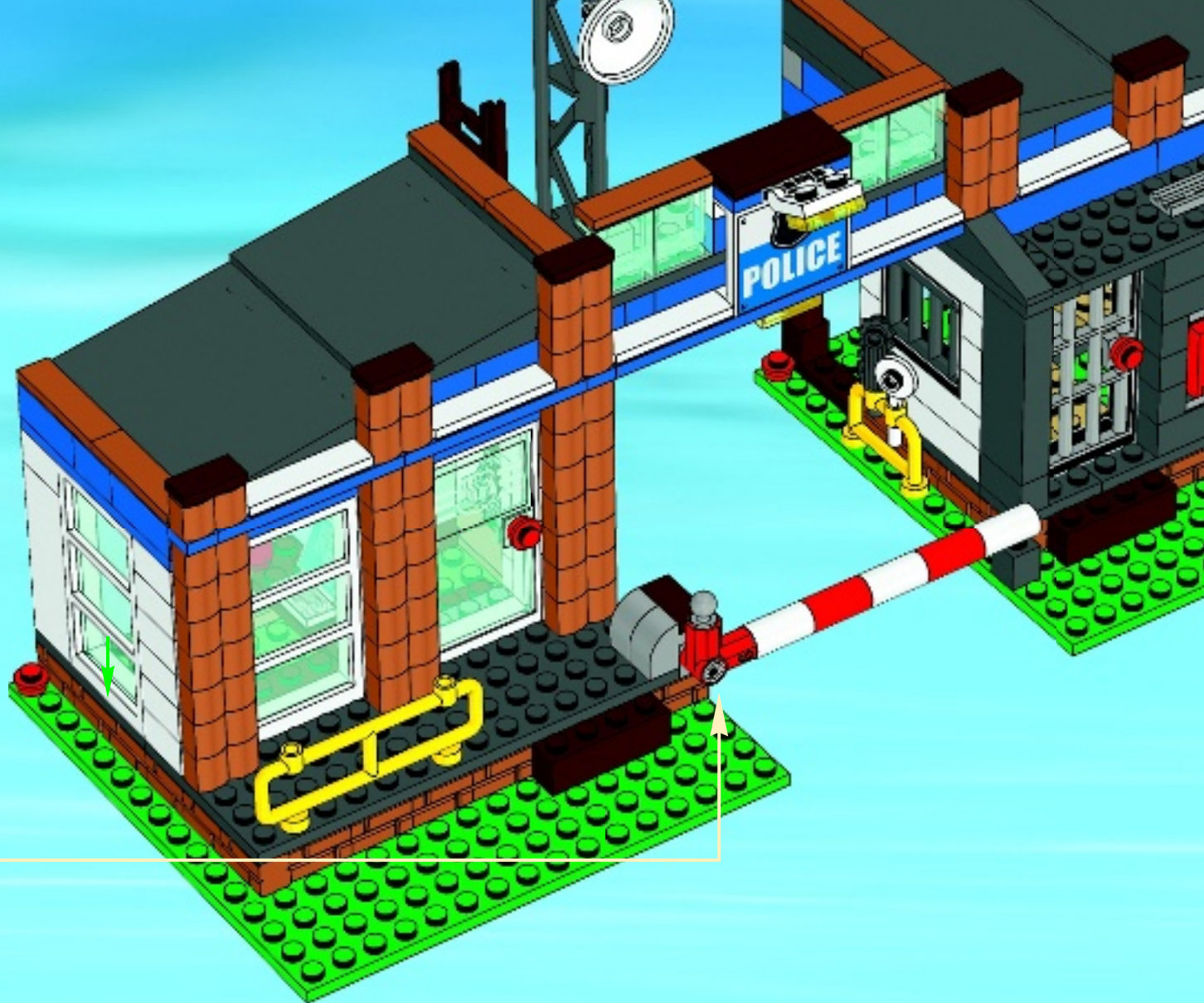

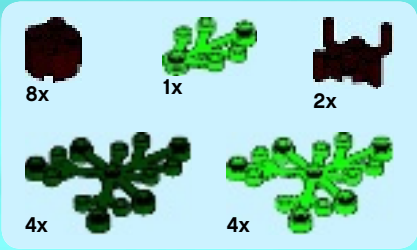

16

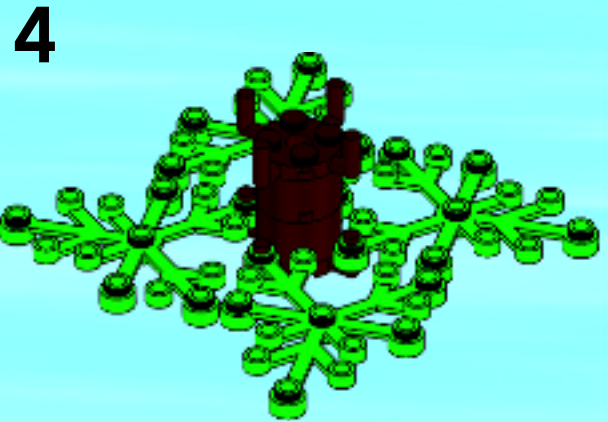
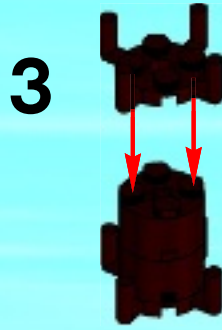
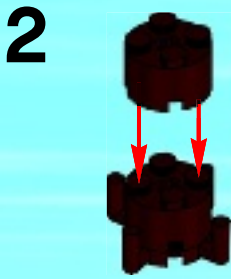

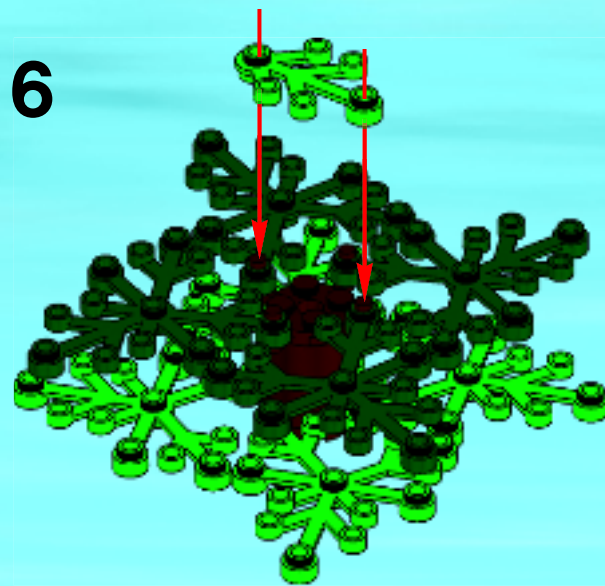
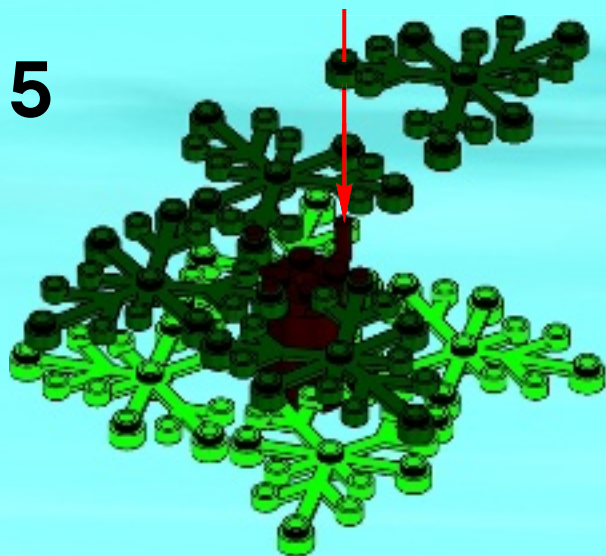

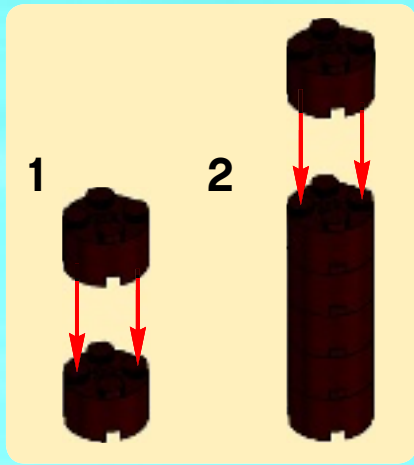

7







BATMAN 2

DC SUPER HEROES



Provisional Rating

©2012 The LEGO Group.™ & © WBIE. (s12)



WIN!

Go to www.LEGOsurvey.com/product to fill out a survey for a chance to win a cool LEGO® Product. No purchase necessary. Open to all residents where not prohibited.

 www.LEGO.com



www.LEGOsurvey.com/product

GEWINNE! WIN!

Nimm an der Umfrage auf www.LEGOsurvey.com/product teil und hab die Chance ein cooles LEGO® Produkt zu gewinnen!
Die Teilnahme am Gewinnspiel führt zu keinerlei Kaufverpflichtungen. Teilnahme in allen nicht ausgeschlossenen Ländern möglich.

Ga naar www.LEGOsurvey.com/product, vul een enquêteformulier in en maak kans op een cool LEGO® product.
Geen aankoopverplichting. Iedereen mag deelnemen, uitgezonderd ingezetenden van landen waar een enquêteverbod geldt.

GAGNE! 当てよう!

Visite www.LEGOsurvey.com/product pour répondre à un questionnaire et avoir une chance de gagner un produit LEGO® très cool!
Aucune obligation d'achat. Ouvert à tous les résidents des pays autorisés.

www.LEGOsurvey.com/product にアクセスして、アンケートにご記入ください。当選者にはレゴ®製品を差し上げます。
お買い上げの必要はありません。
禁止されていない限り、すべての皆様にご利用いただけます。