

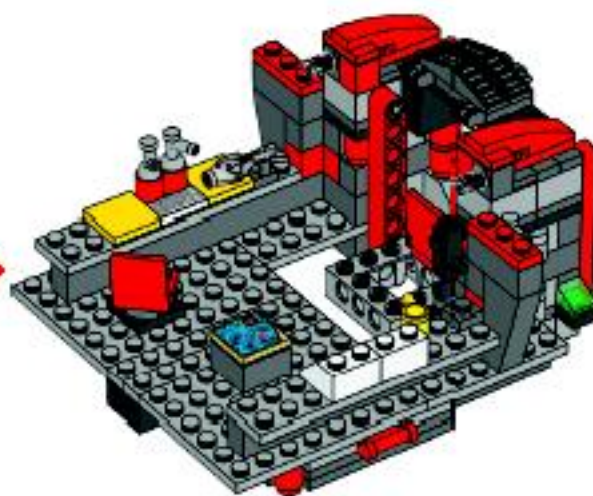

ATLANTIS

8077

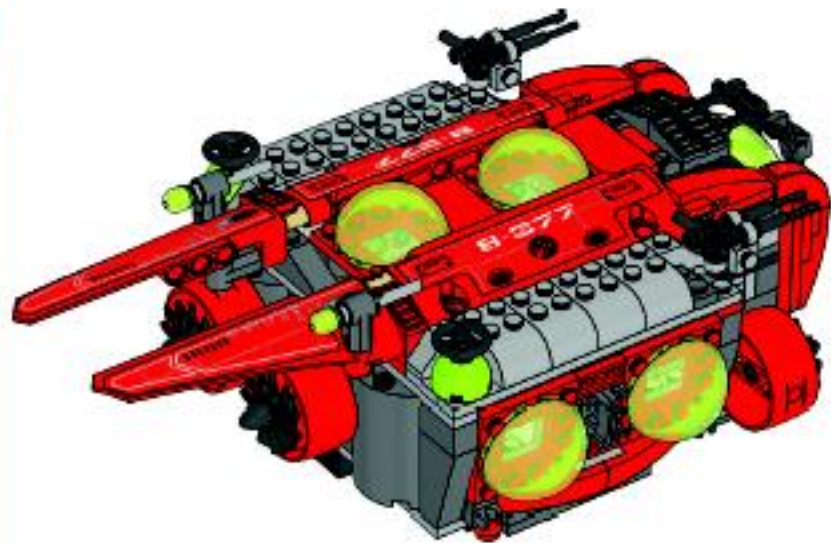



1x



1x

1

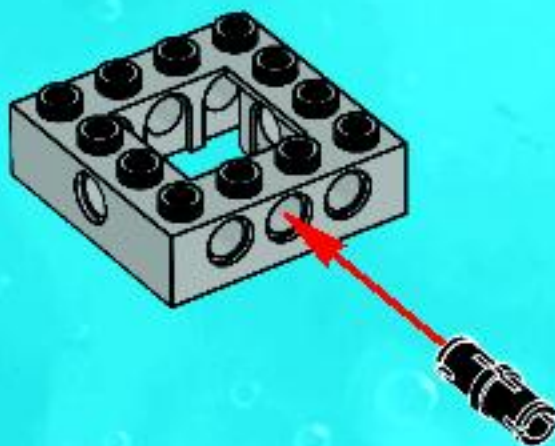

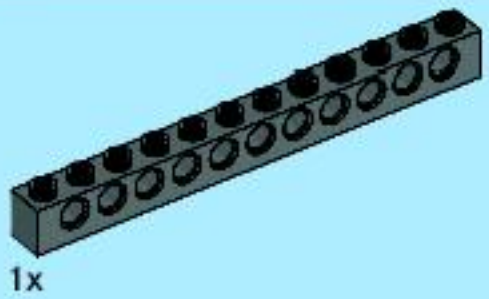

2



3

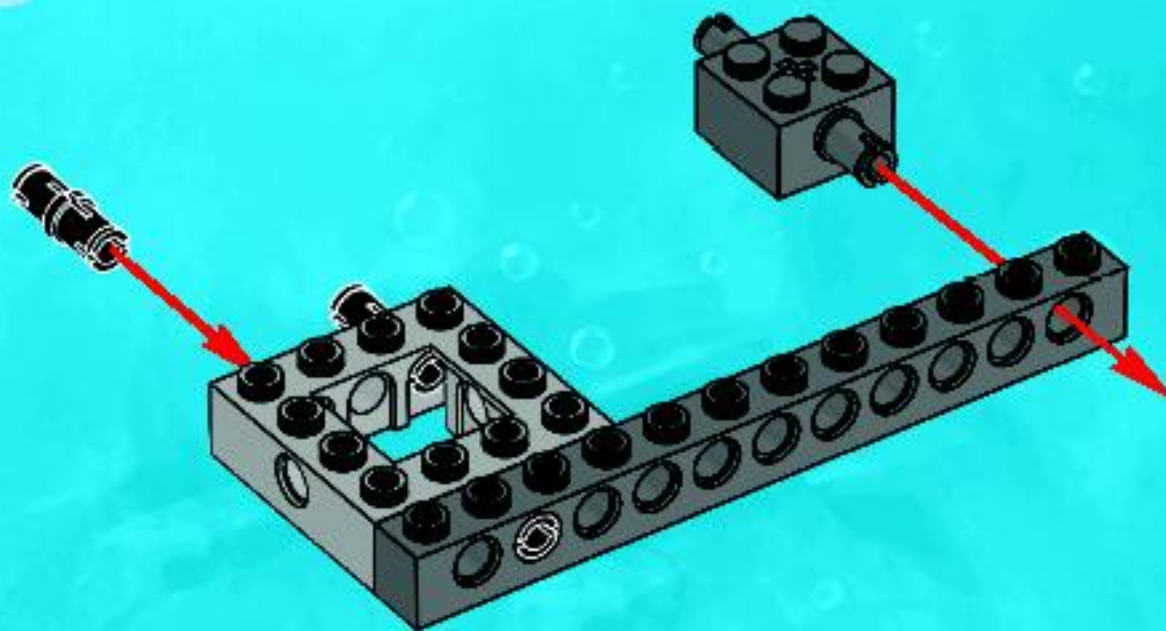



1x



1x

4

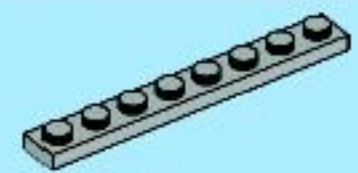
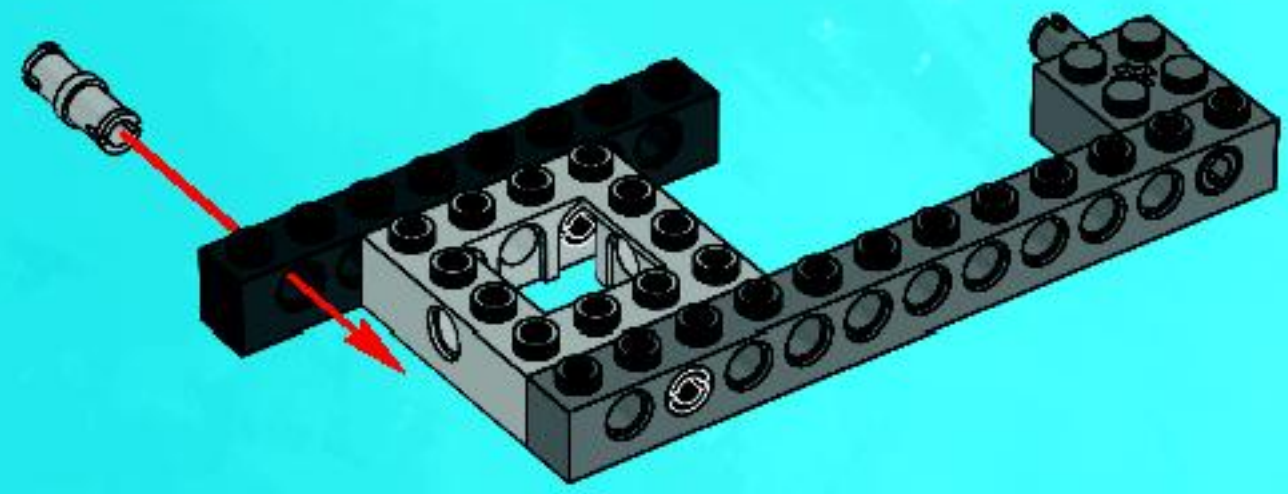

1x

5

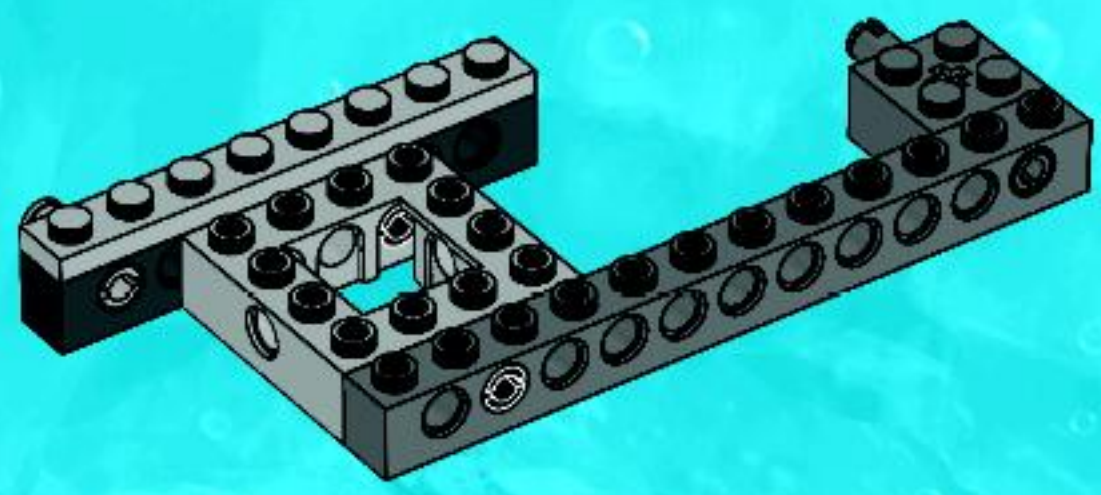

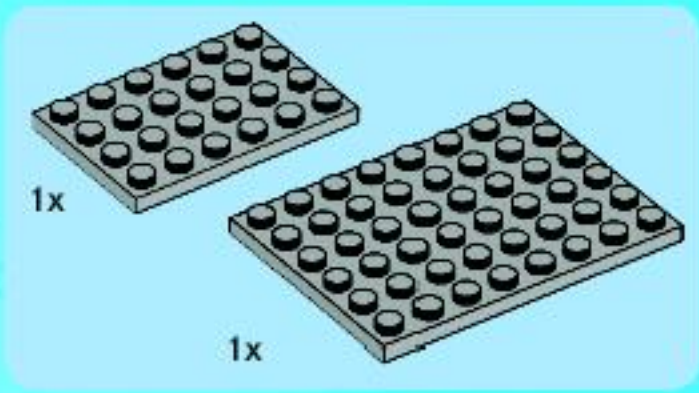

6

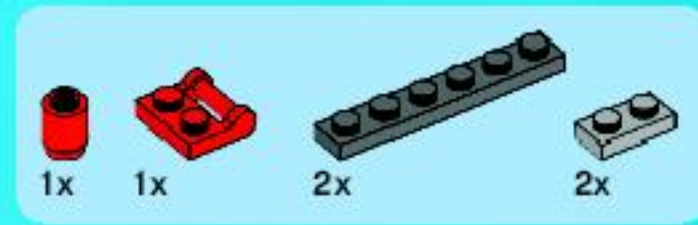
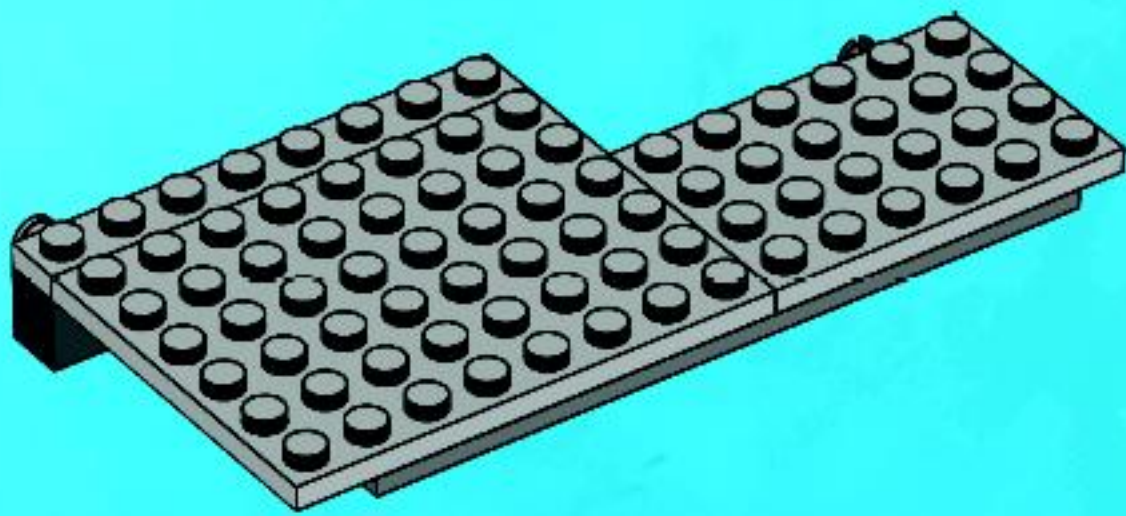

7

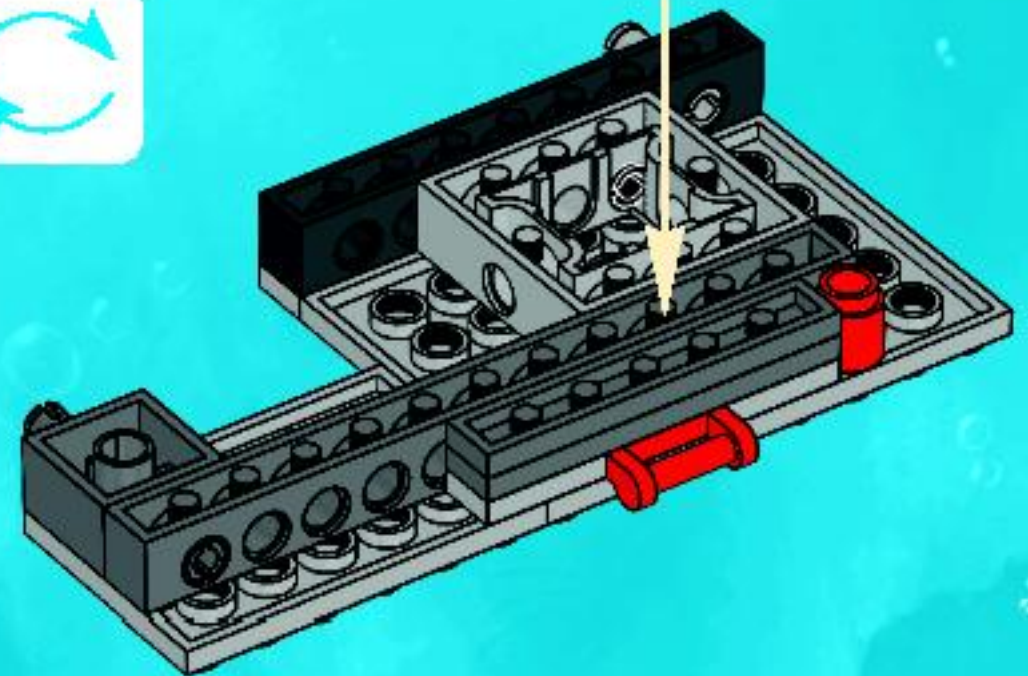
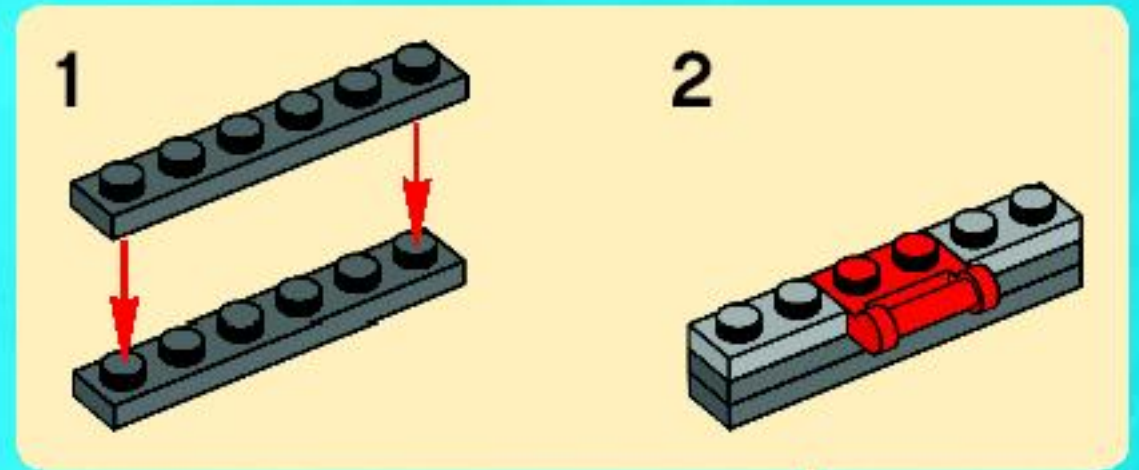

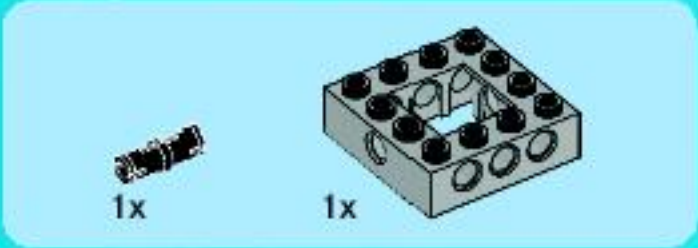

1

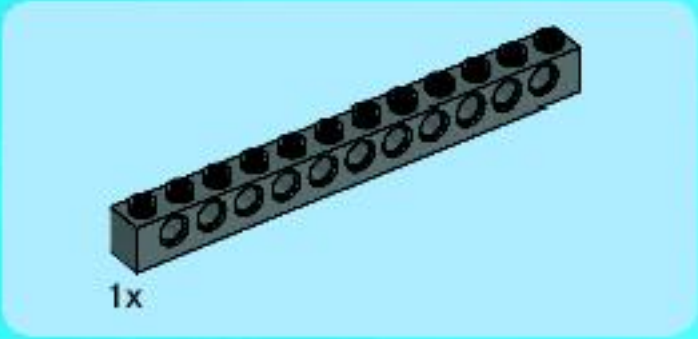
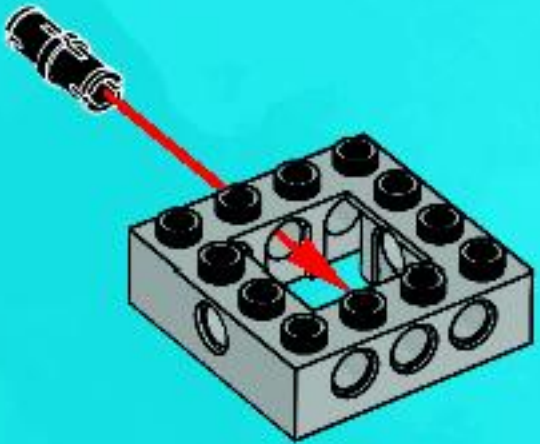

2

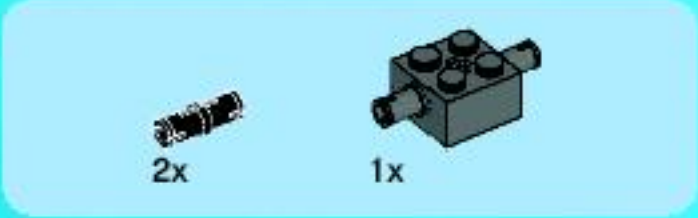
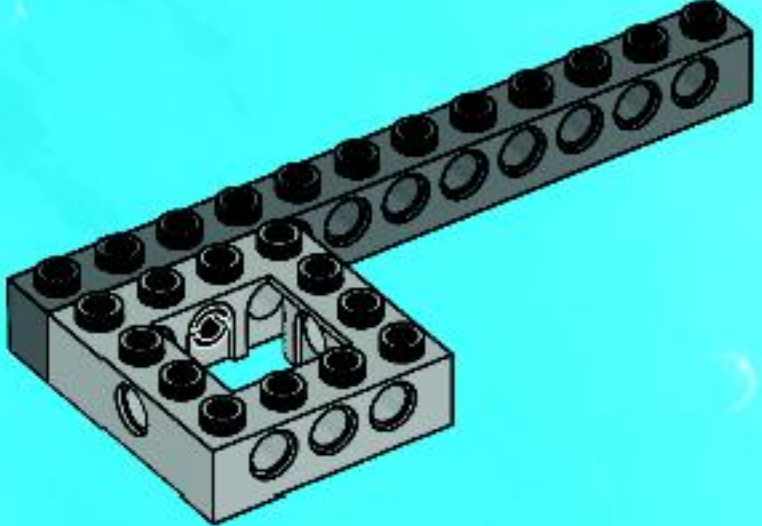

3

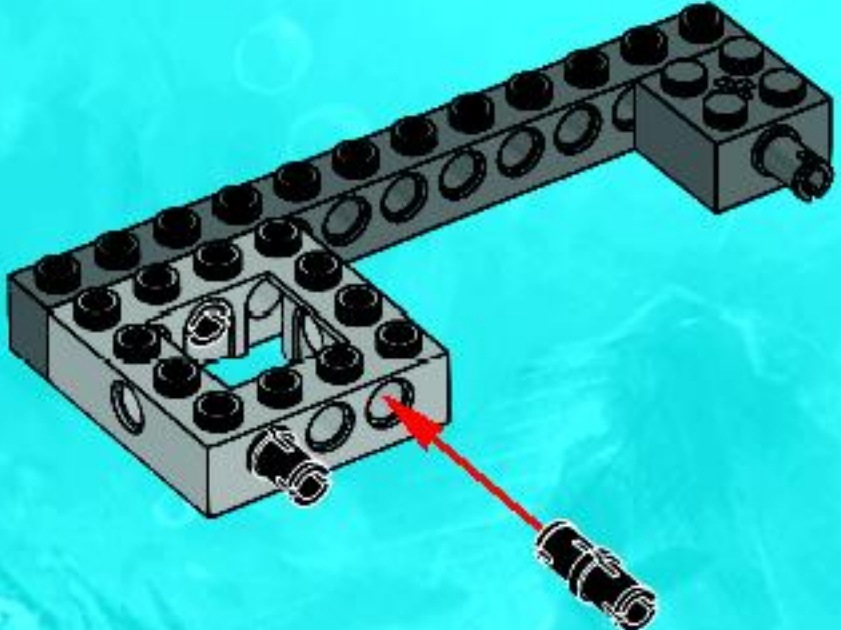



1x

4

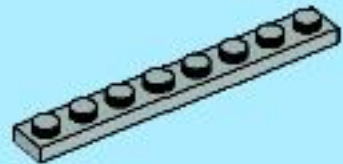
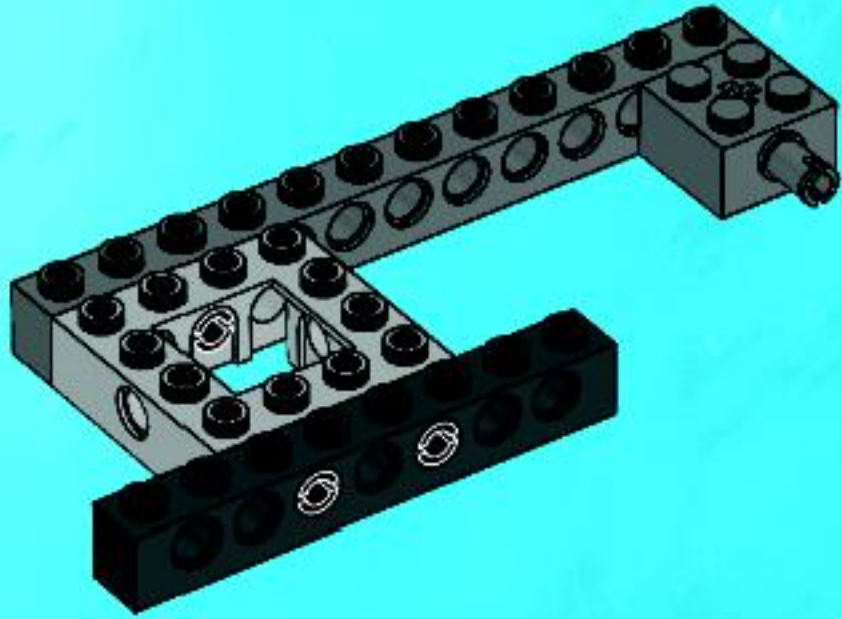

1x

5

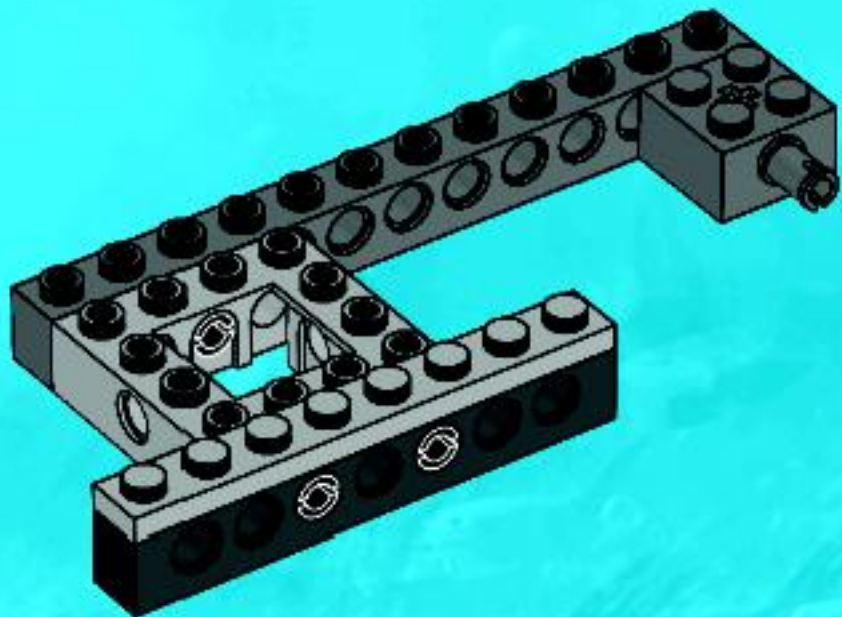

1x



1x

6

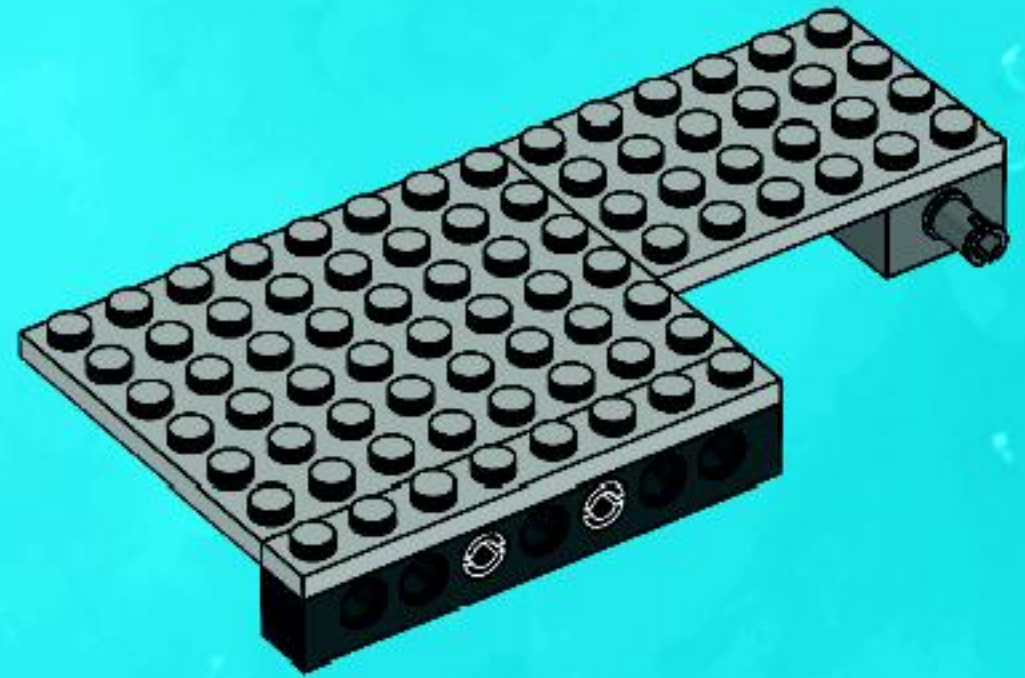

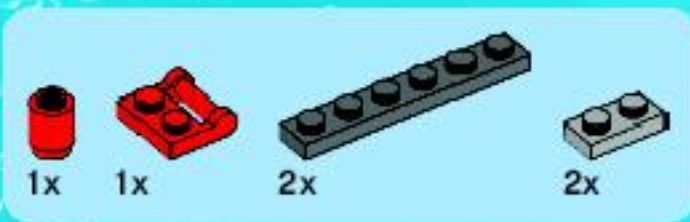

7

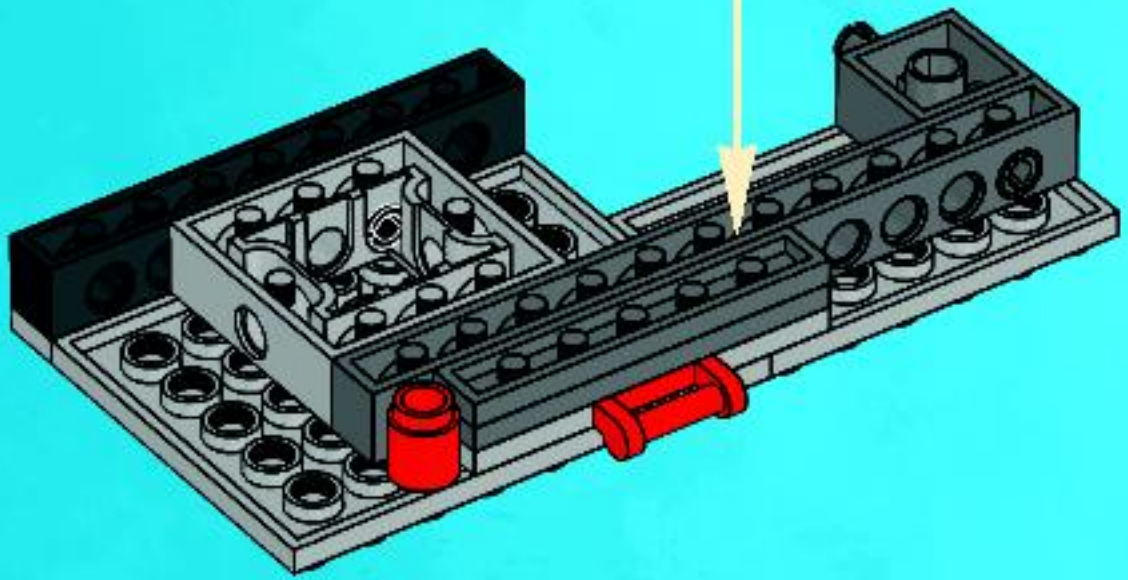
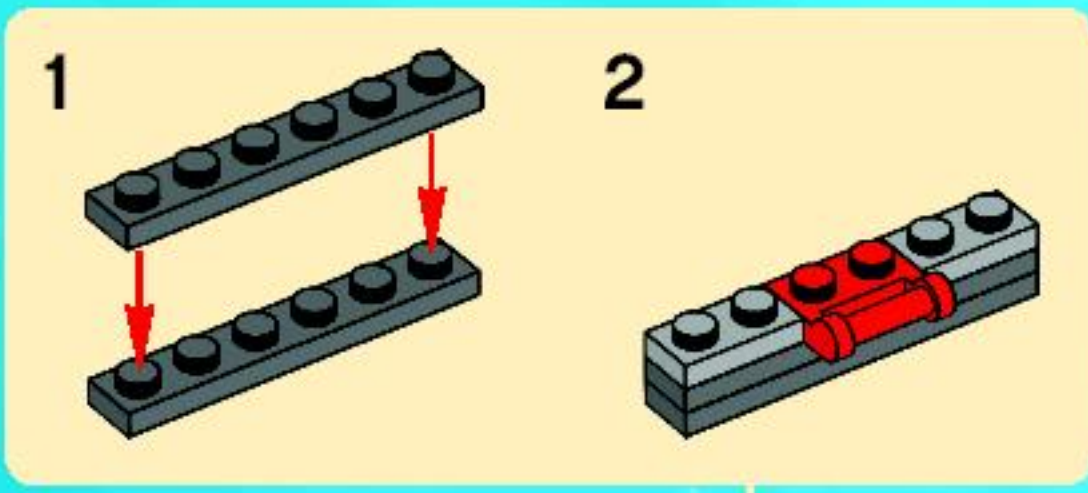

8



9

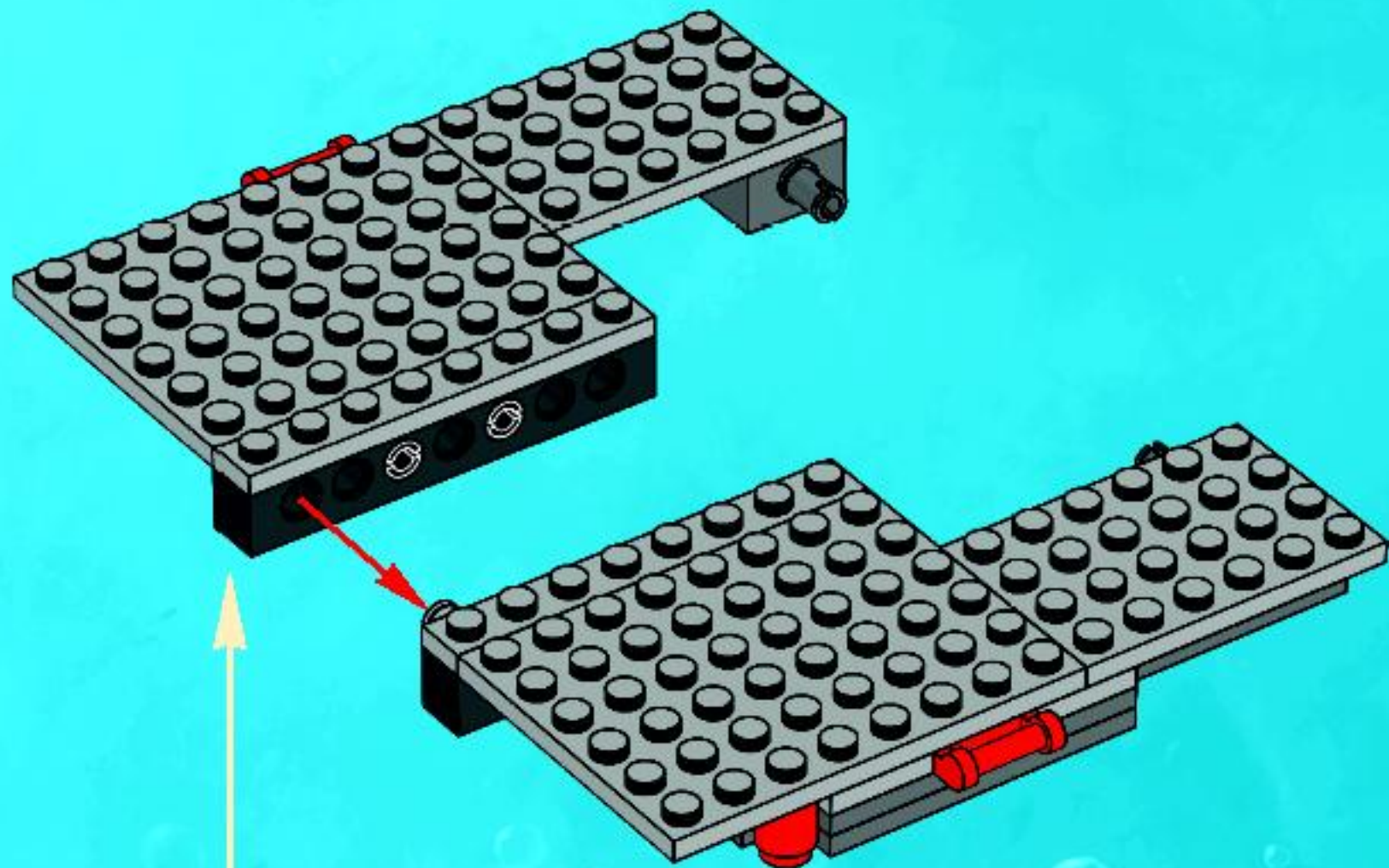

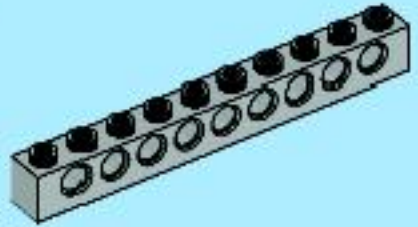

1x



2x

1

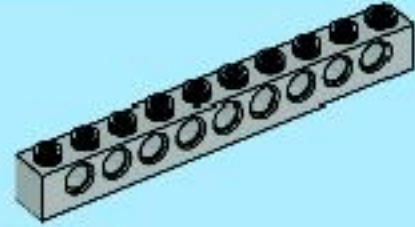
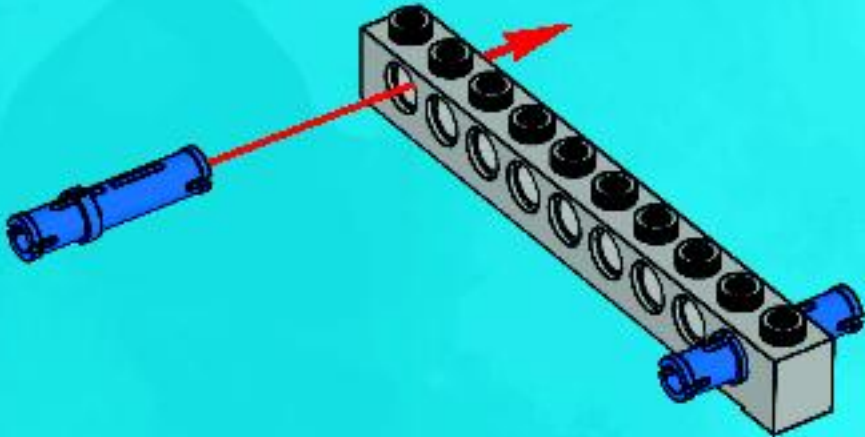

1x

2

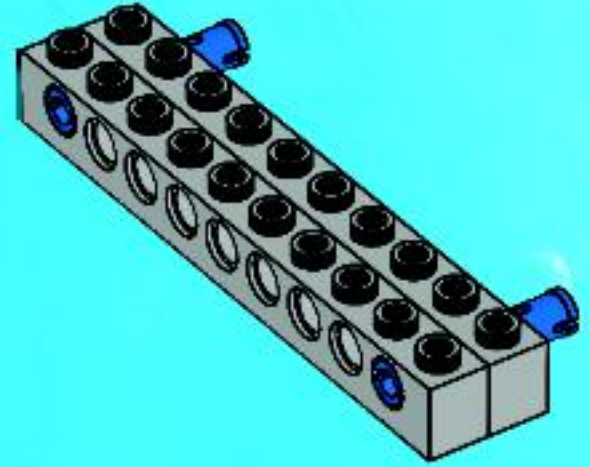

2x

3

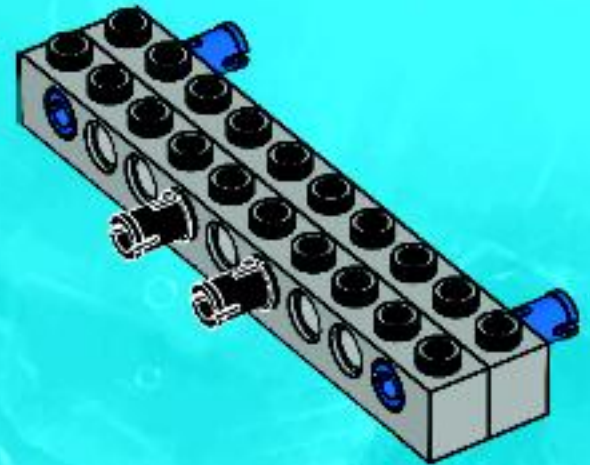

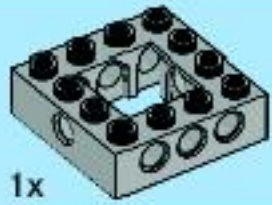

1x

4

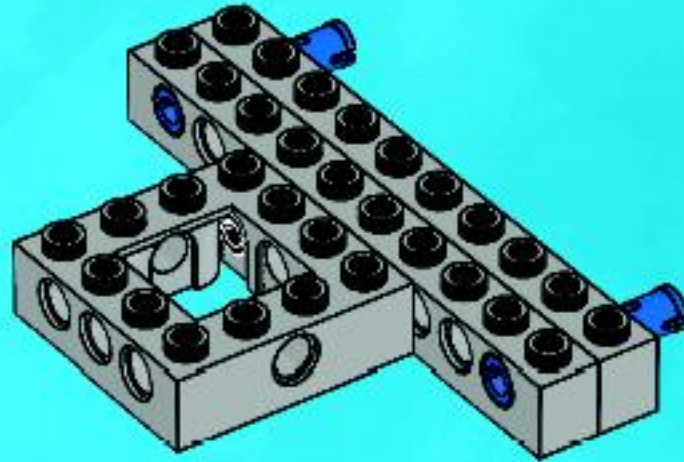

2x

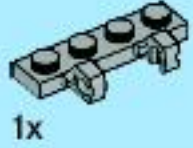

1x

5

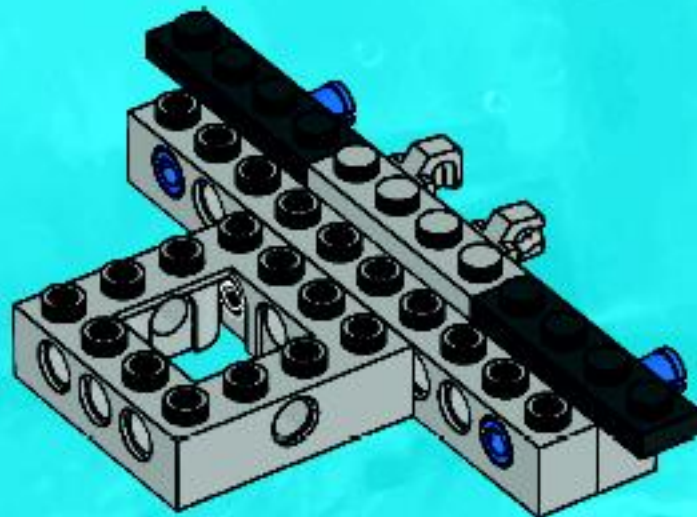



1x

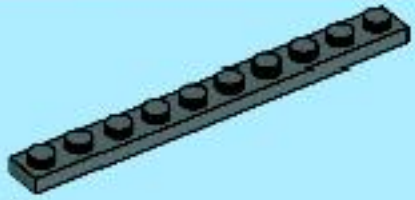

1x

6

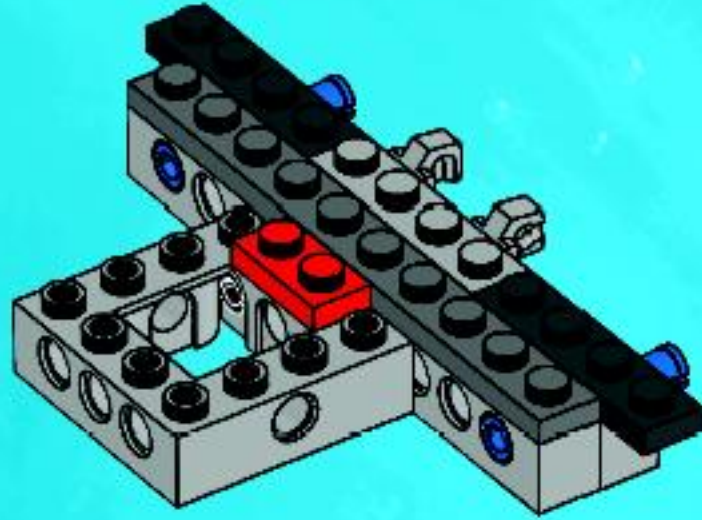

2x



2x



1x



1x

7

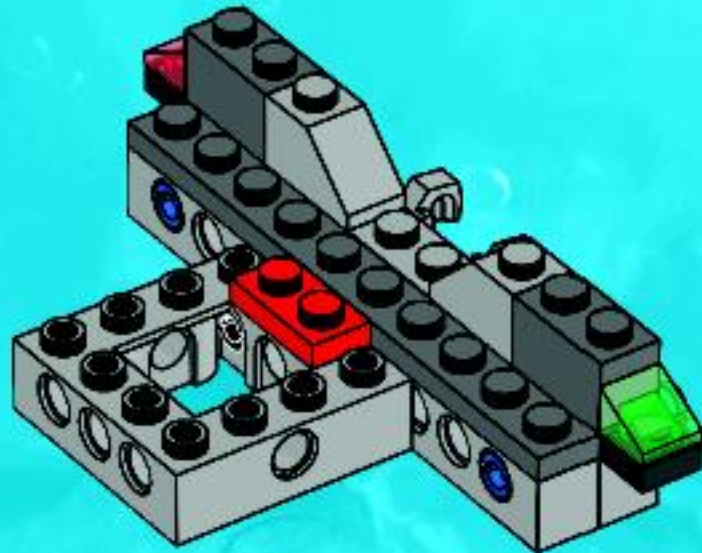



8

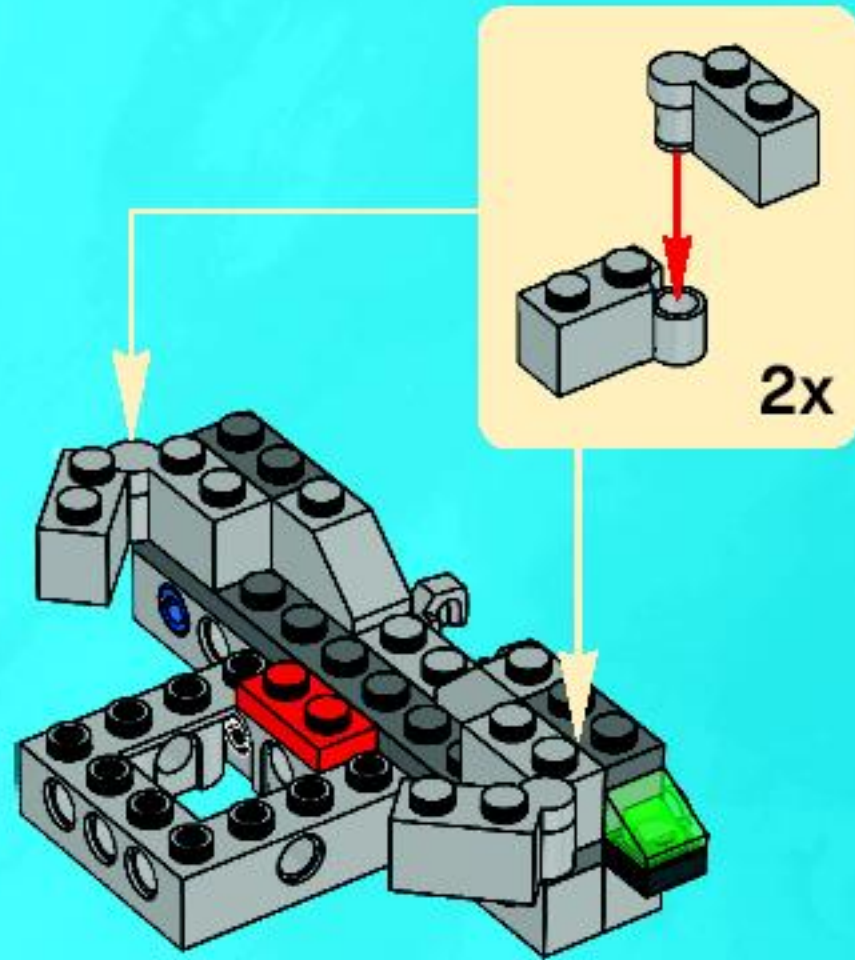

9

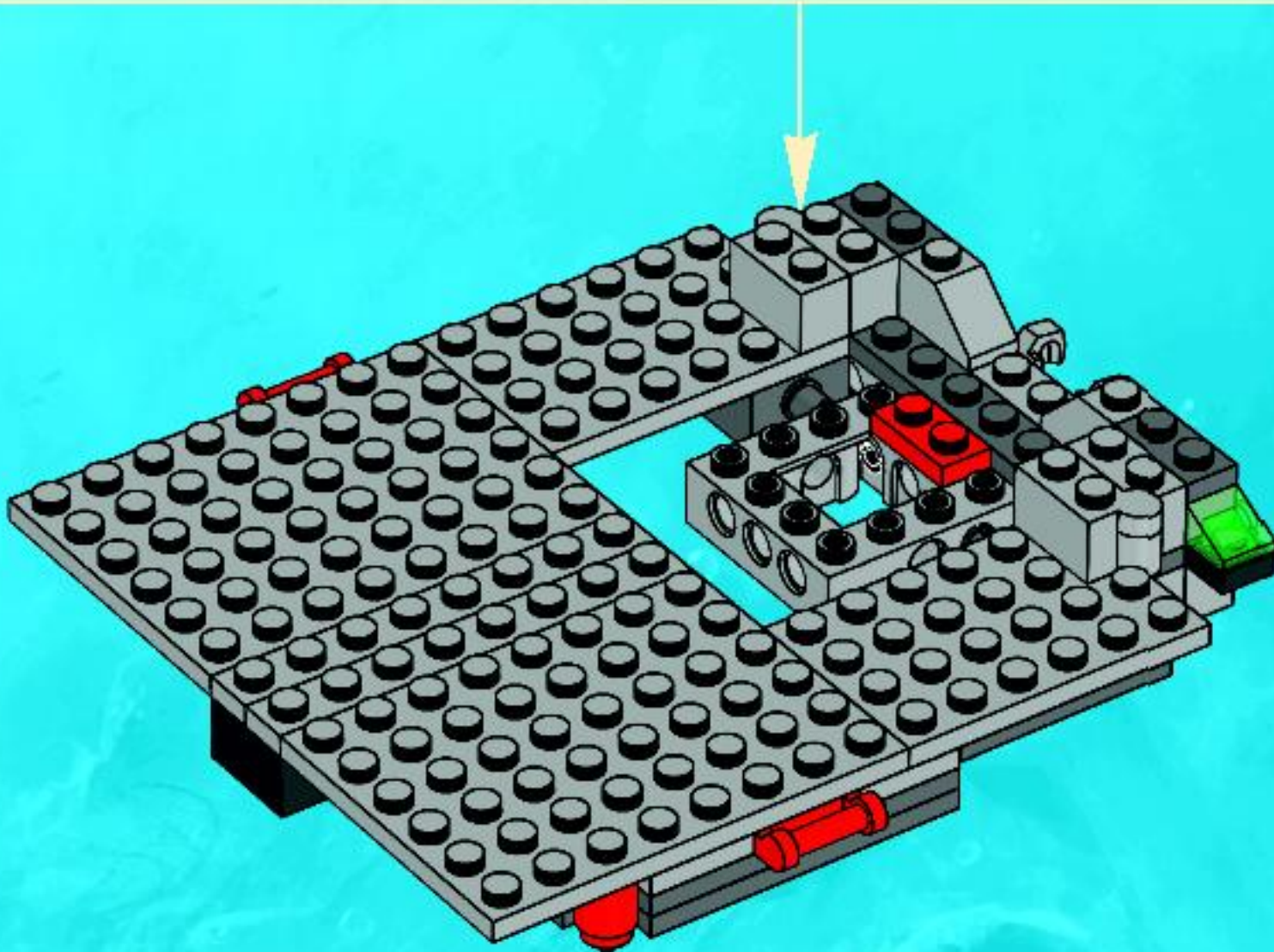

10

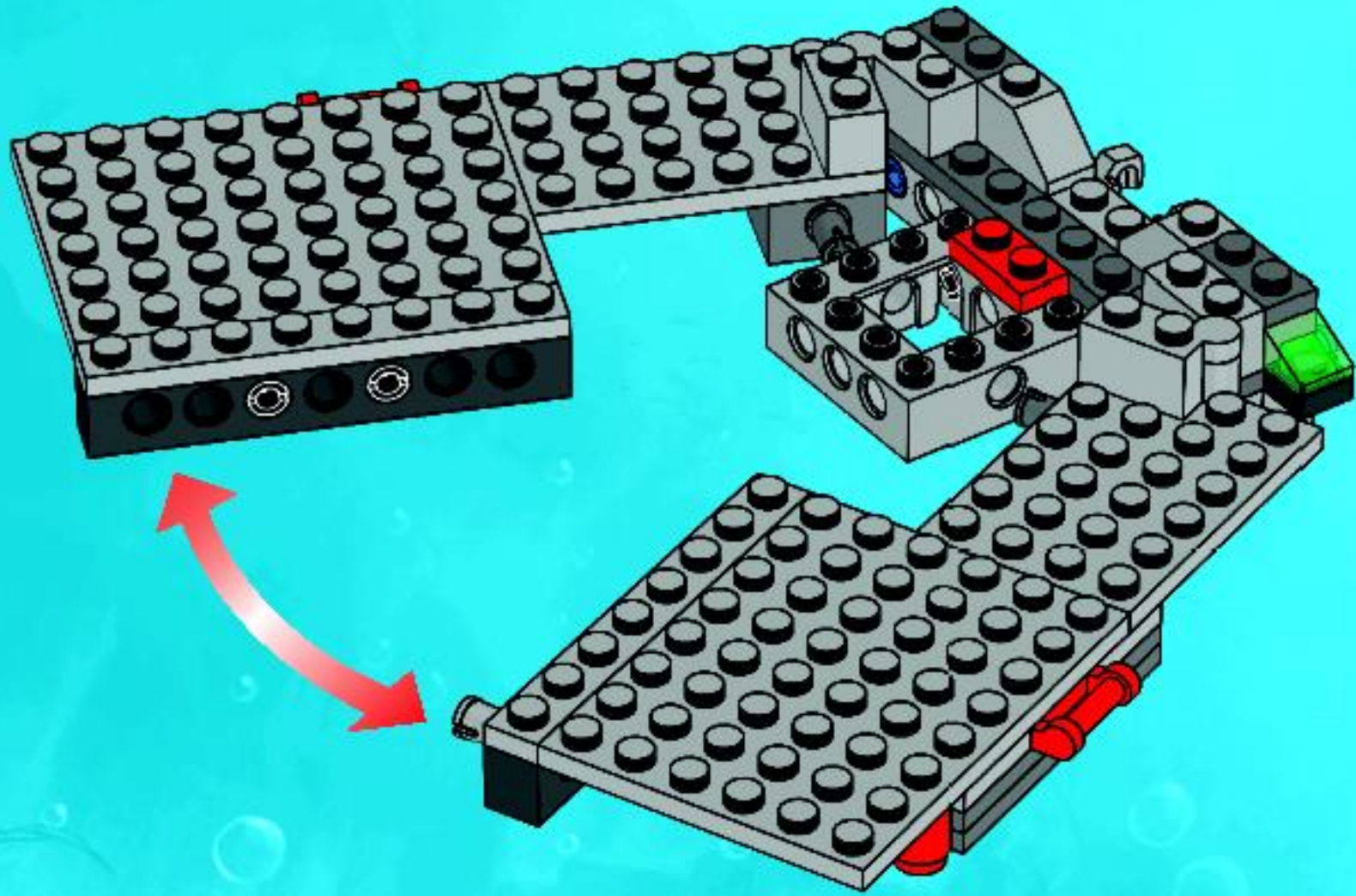

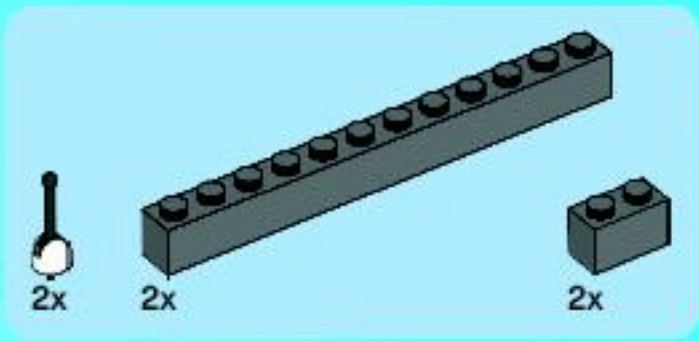

11

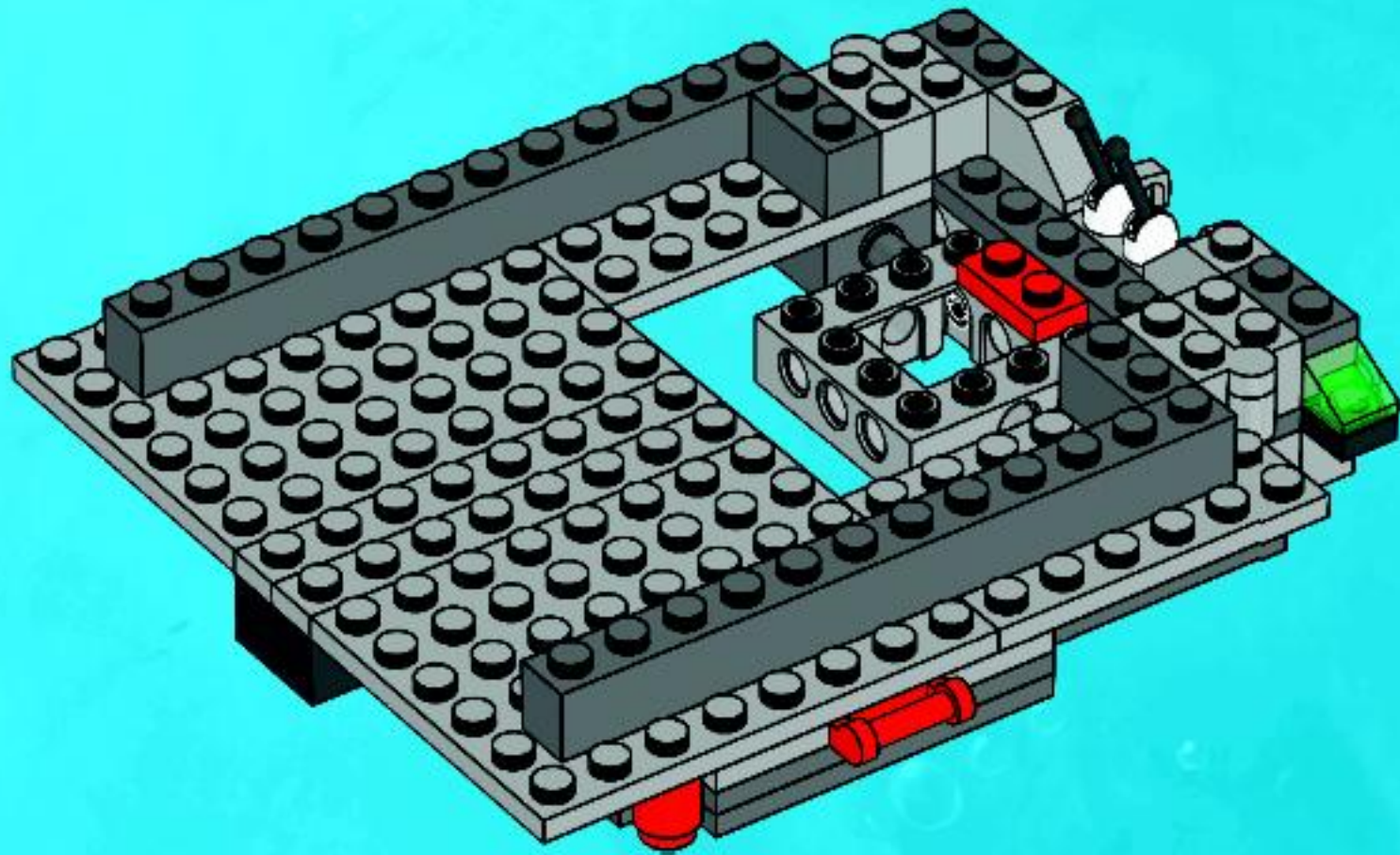



2x



1x



3x

12

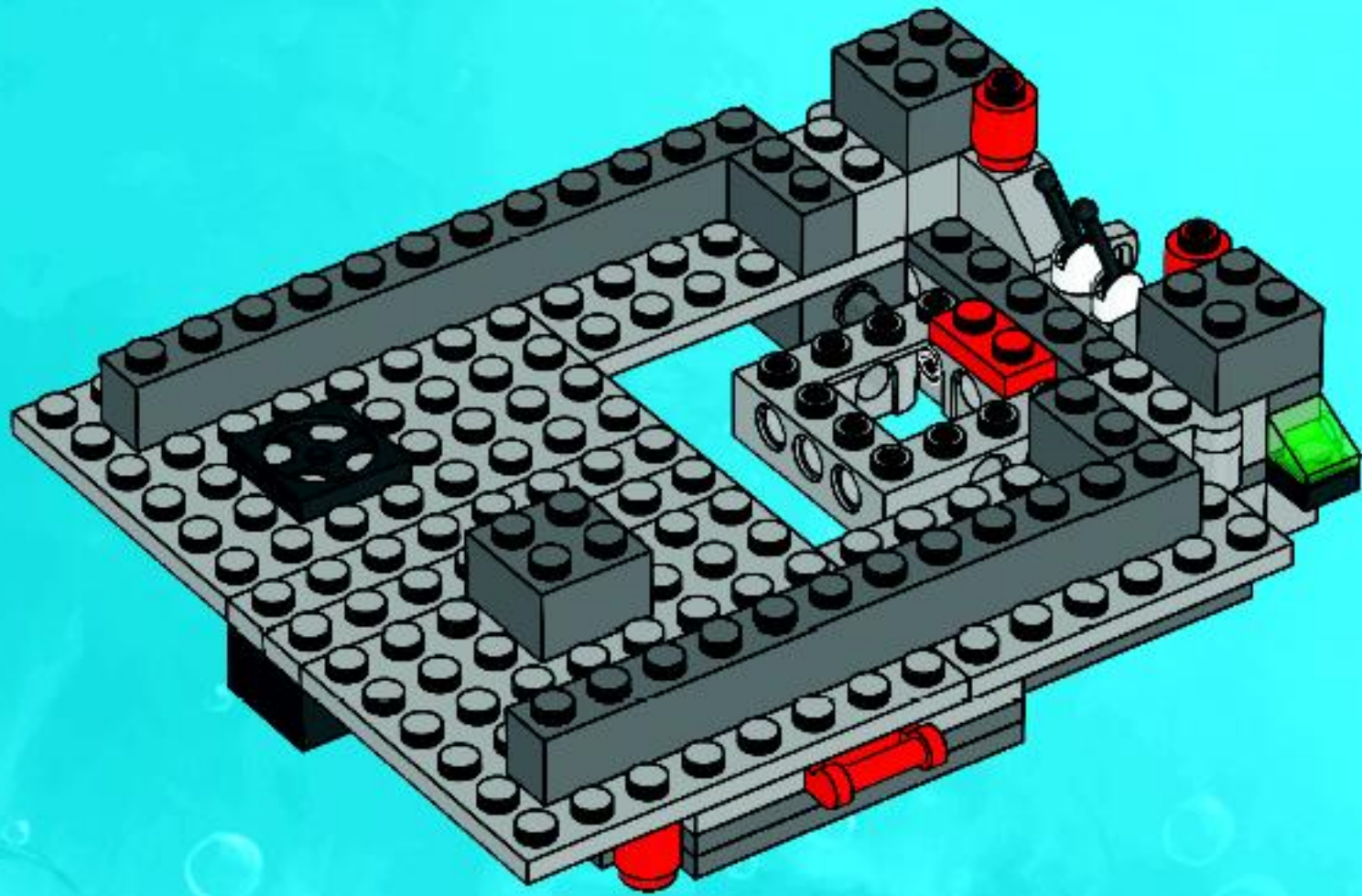



2x



1x



1x

13

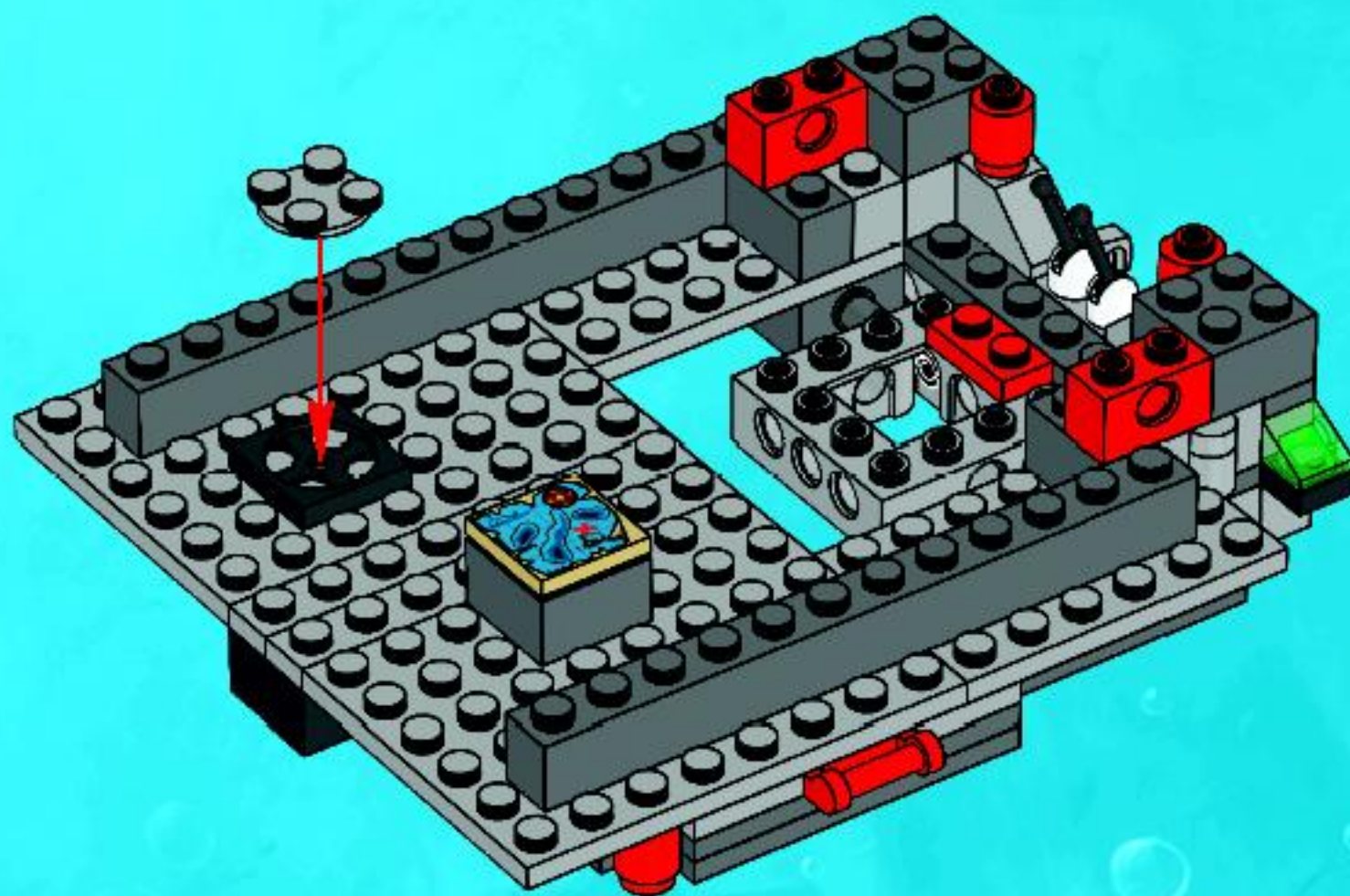



2x



1x



2x

14

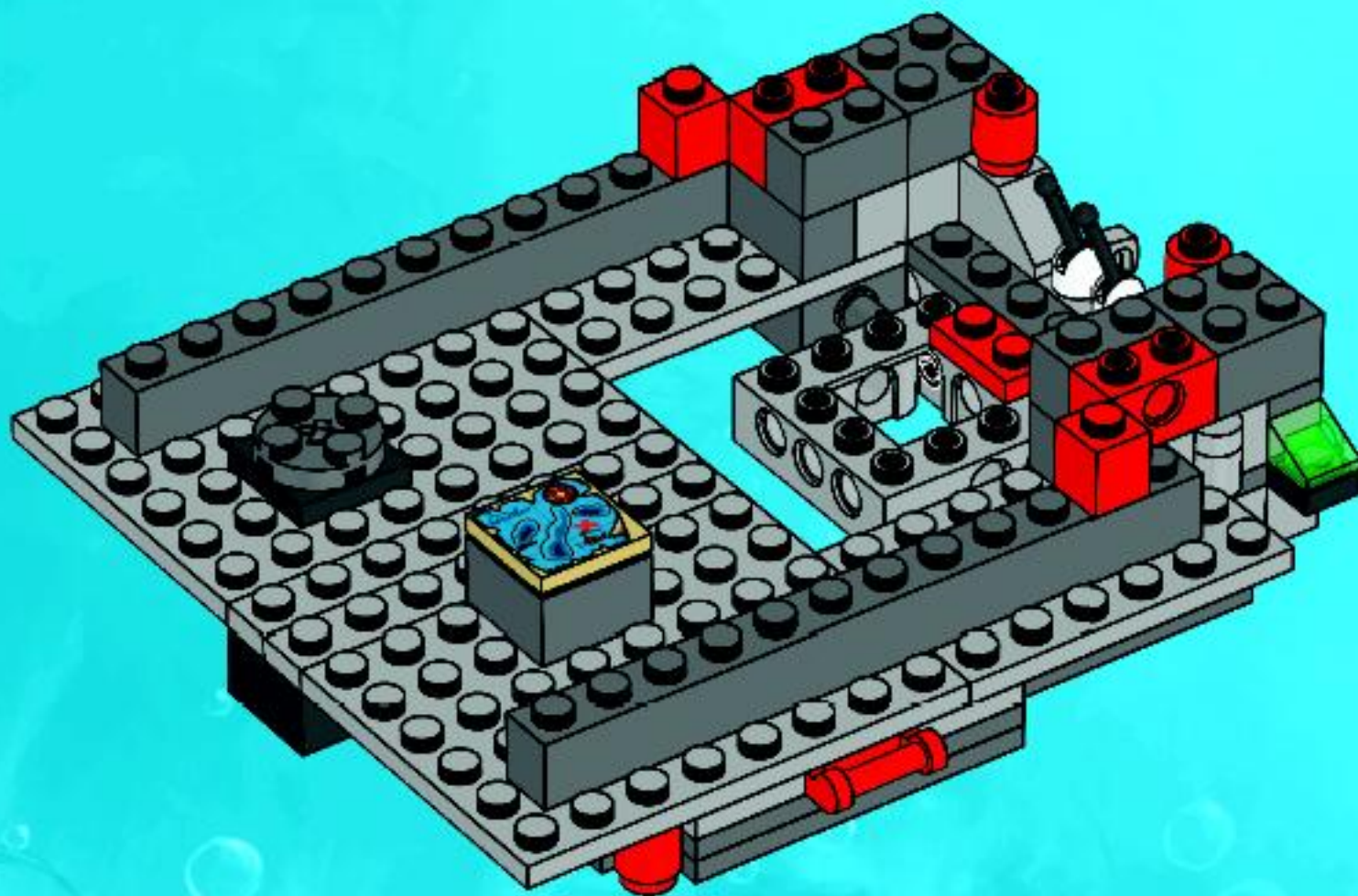

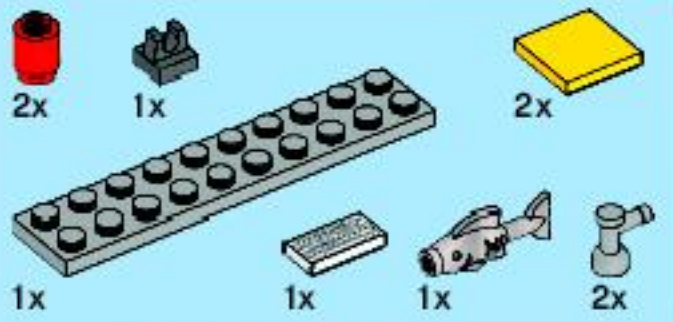

15

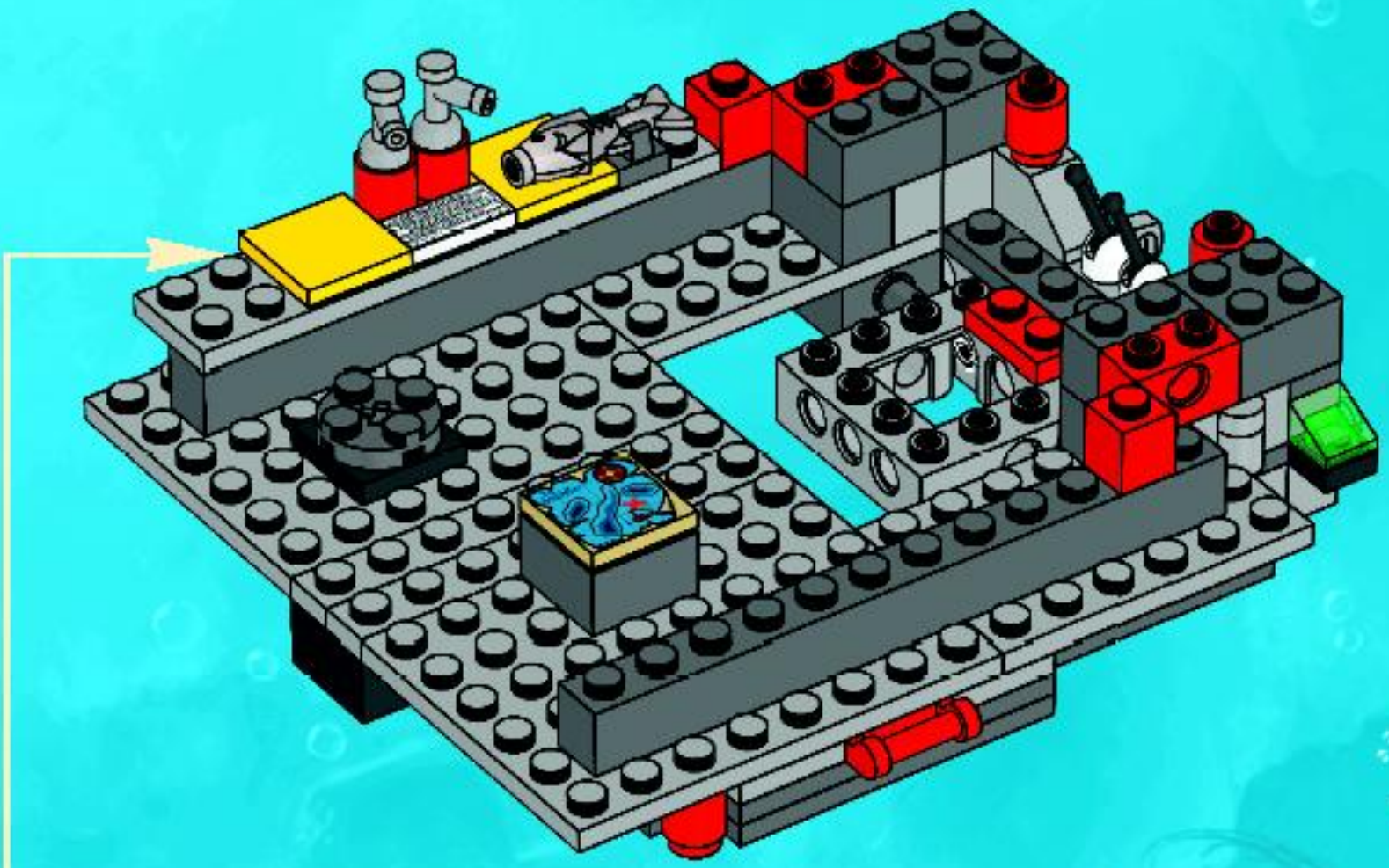
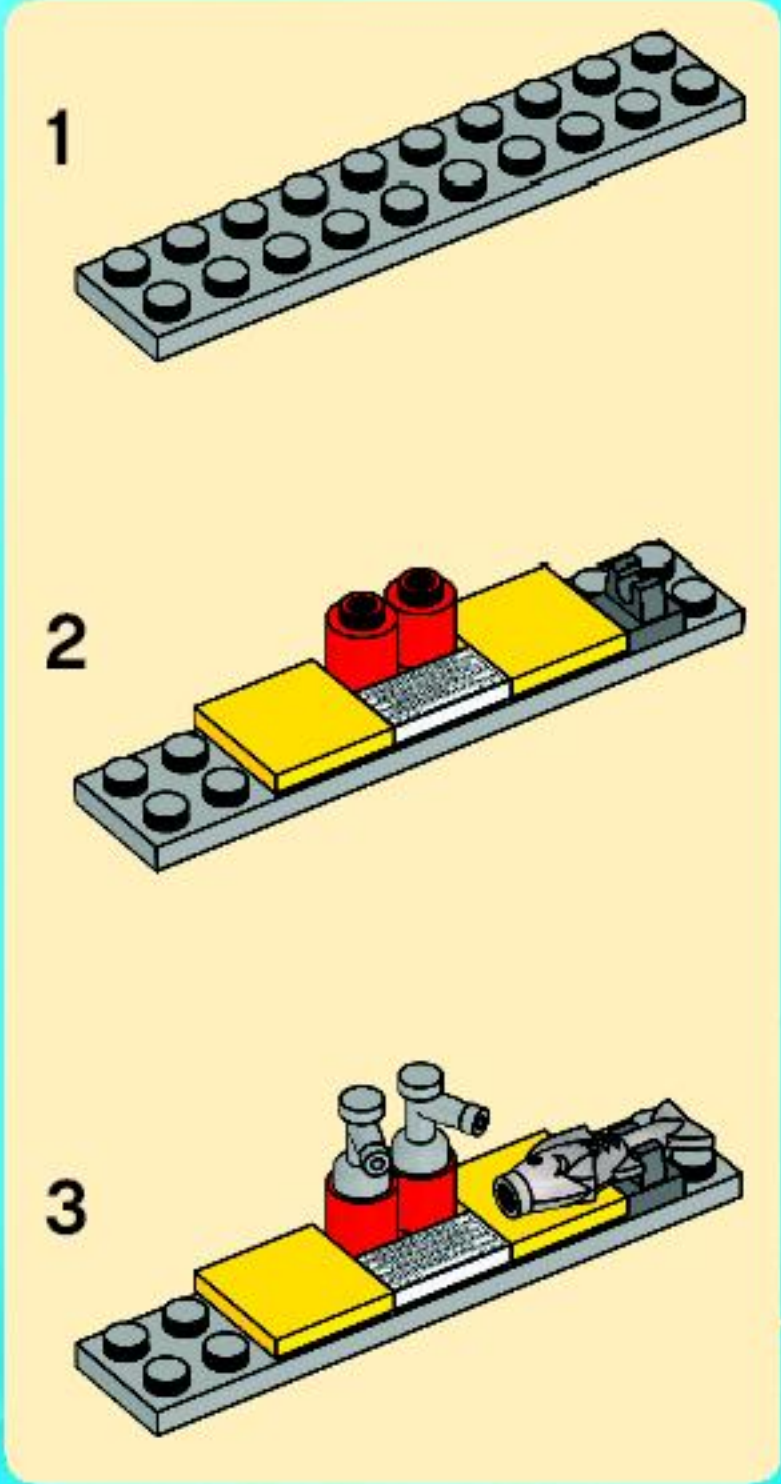

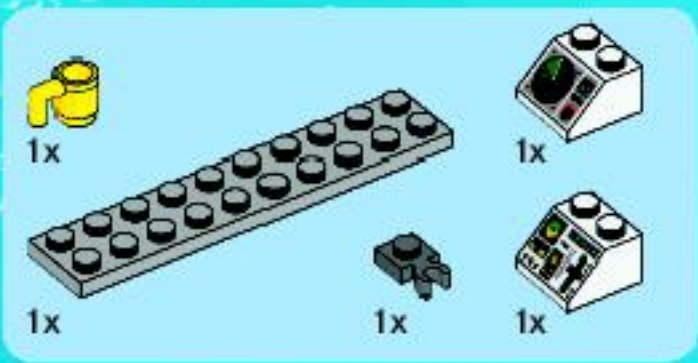

16

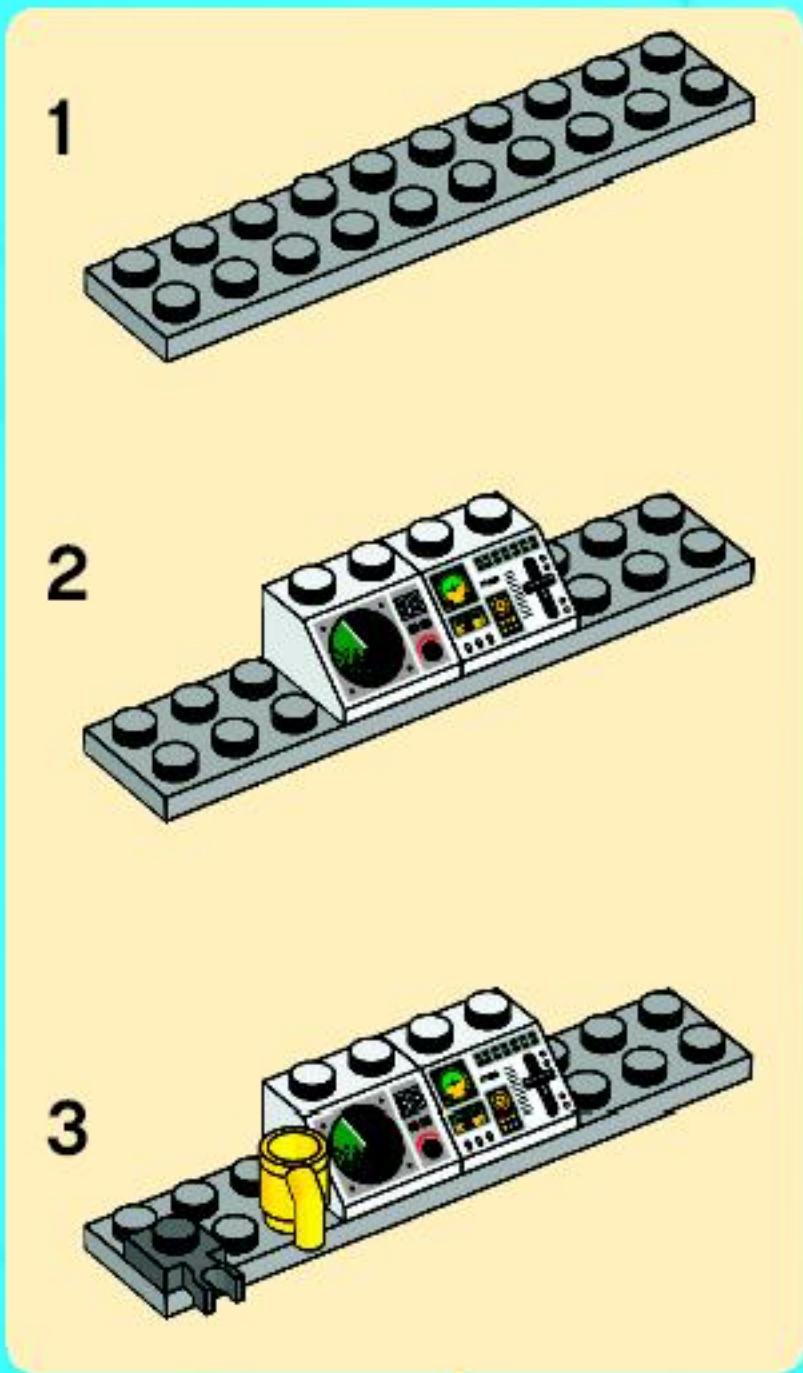
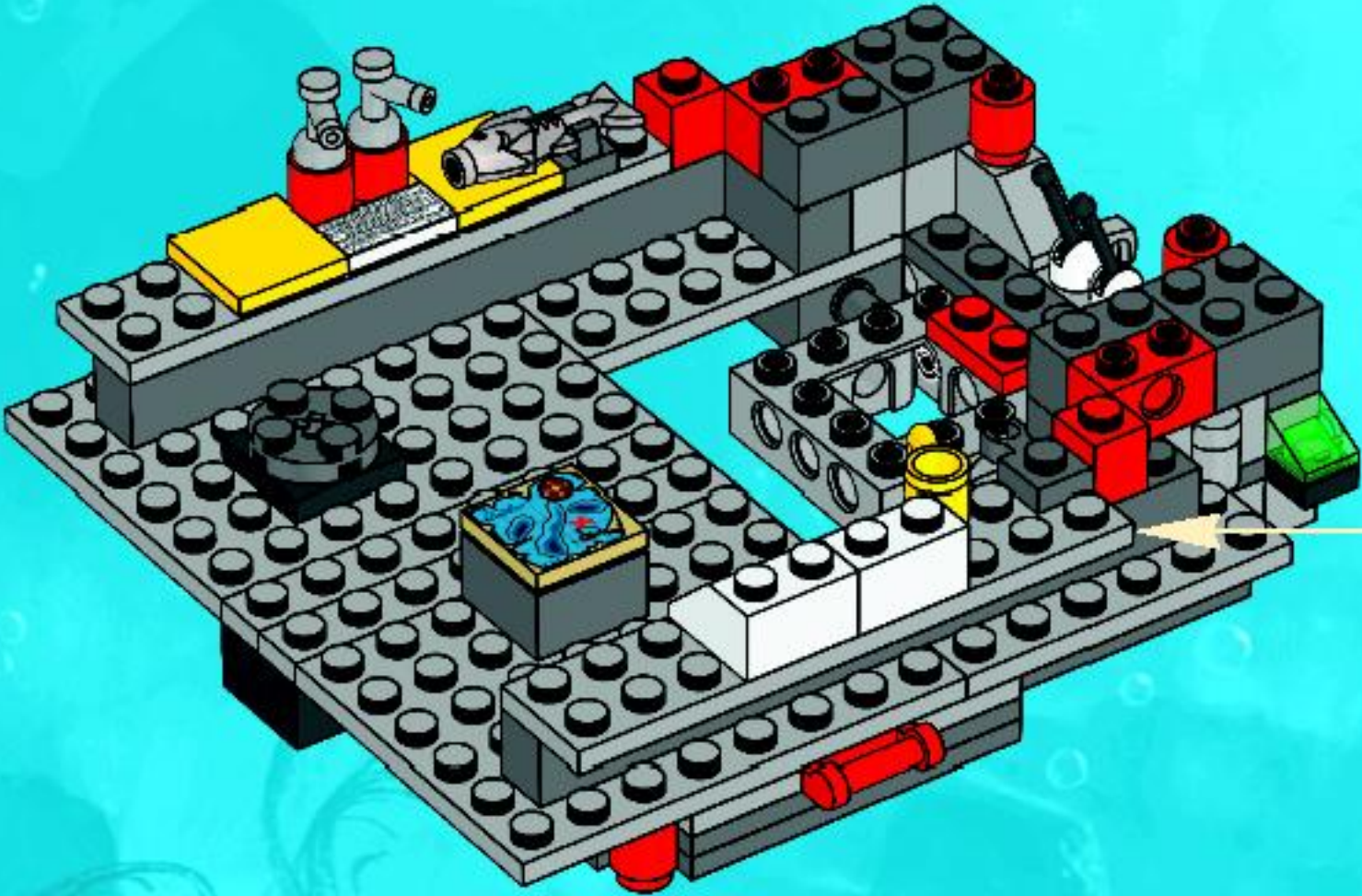



2x



2x



2x

17

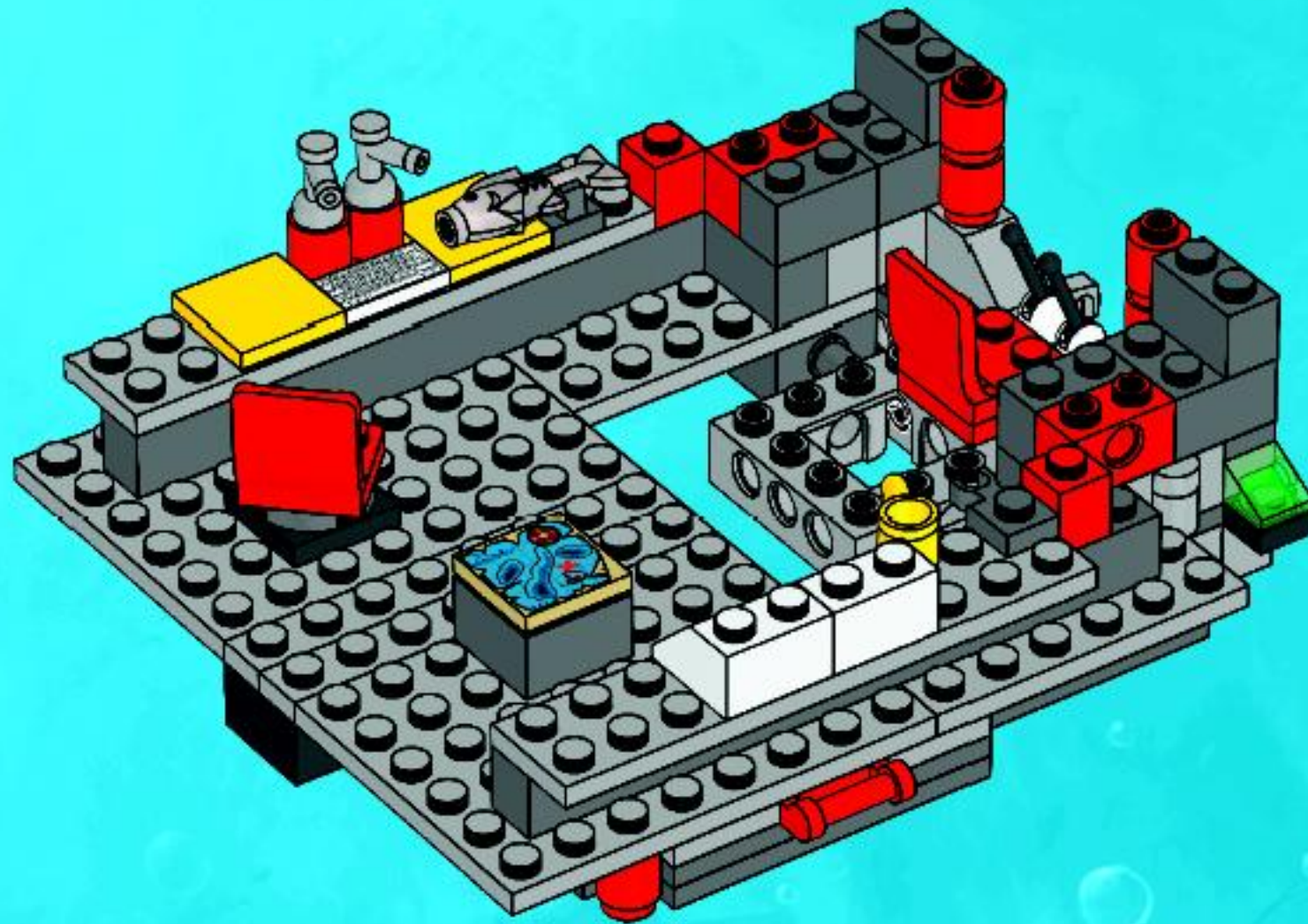



18

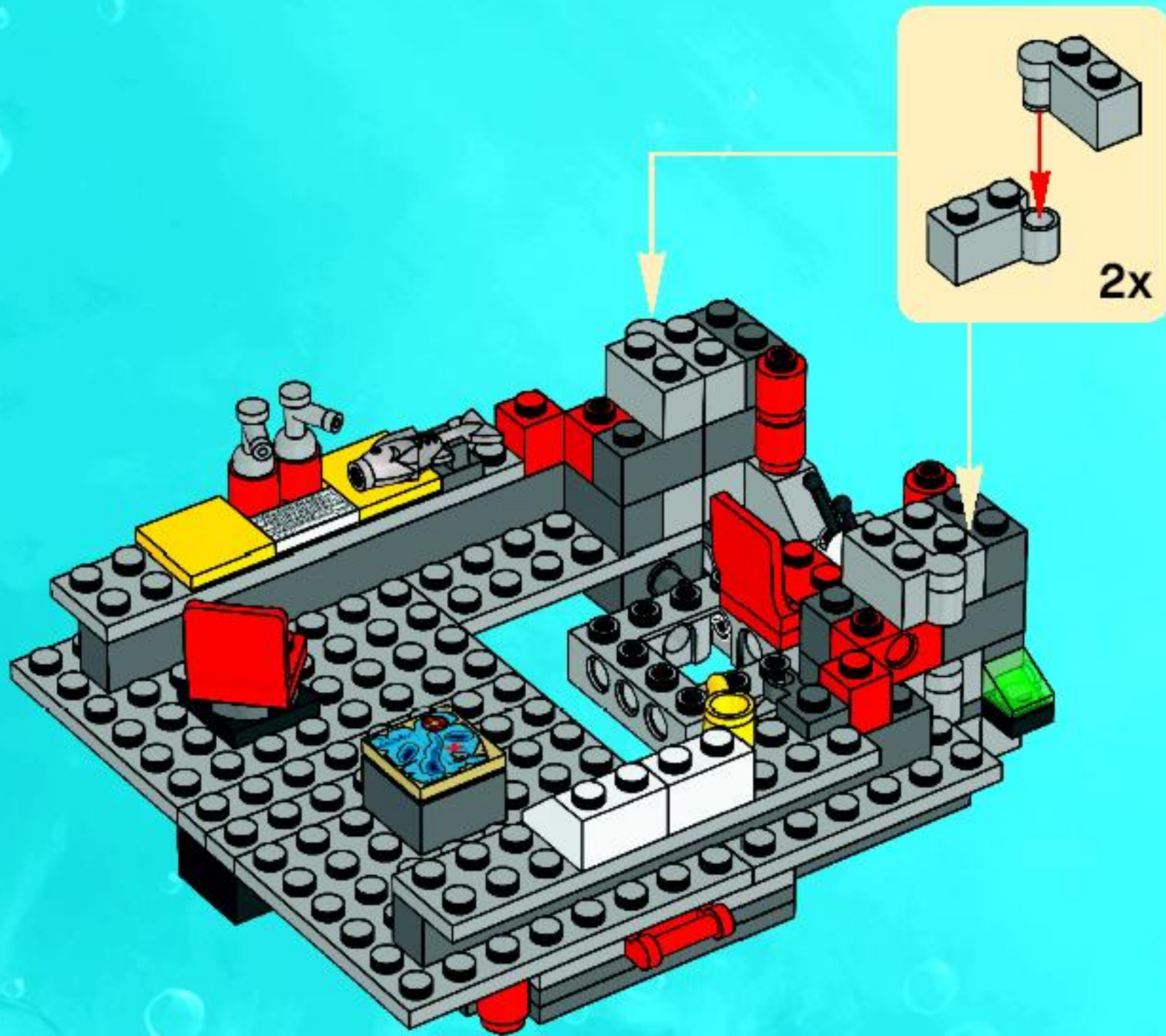



2x



2x

19

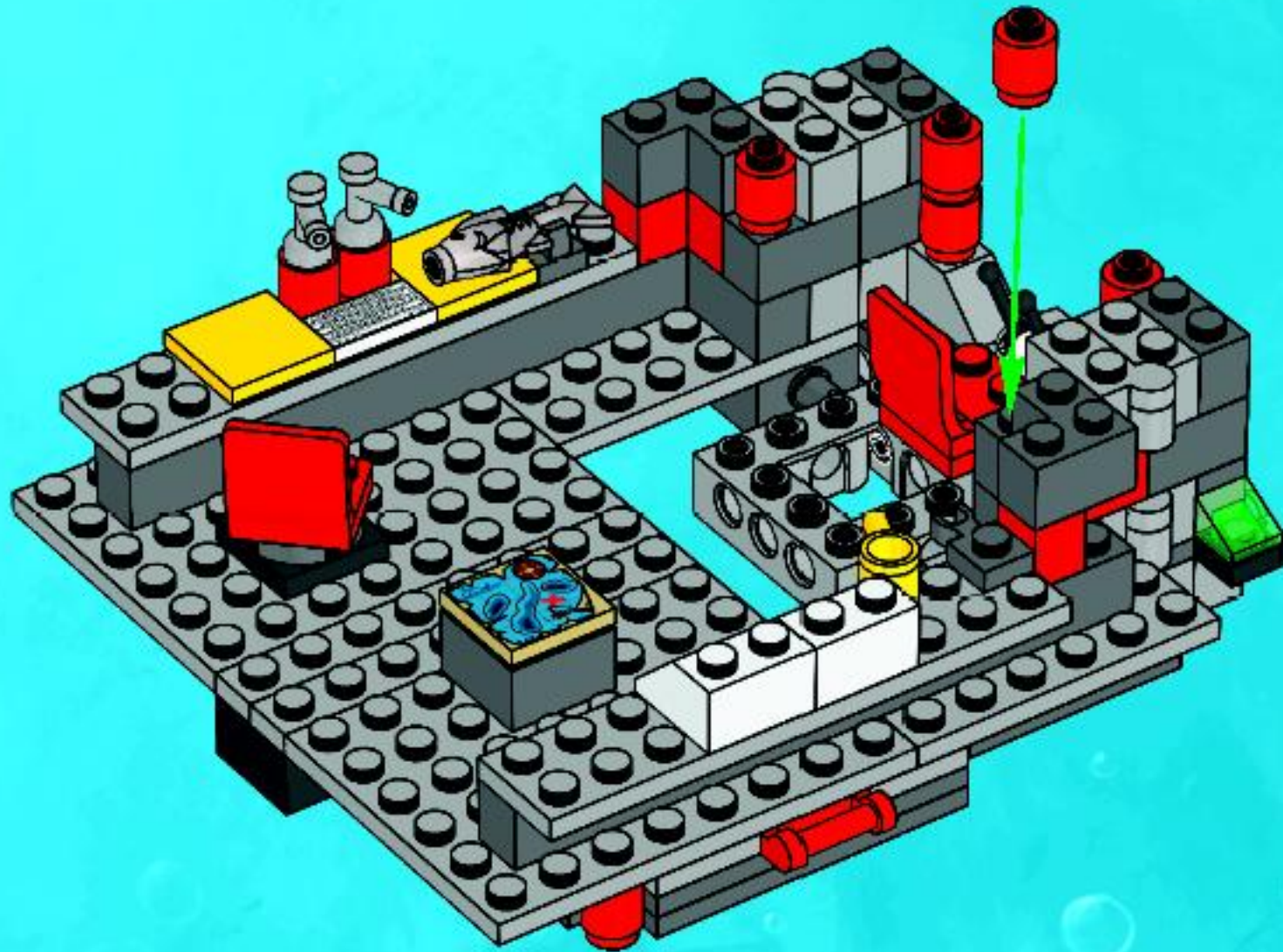

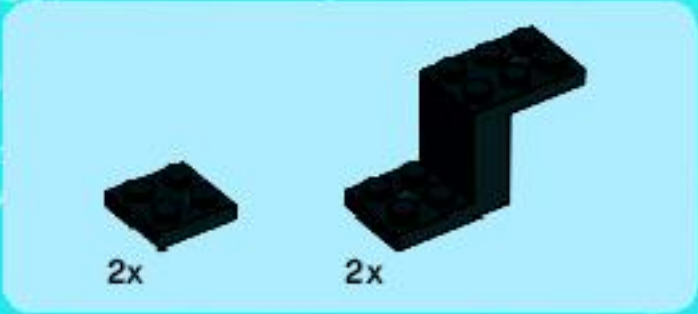

20

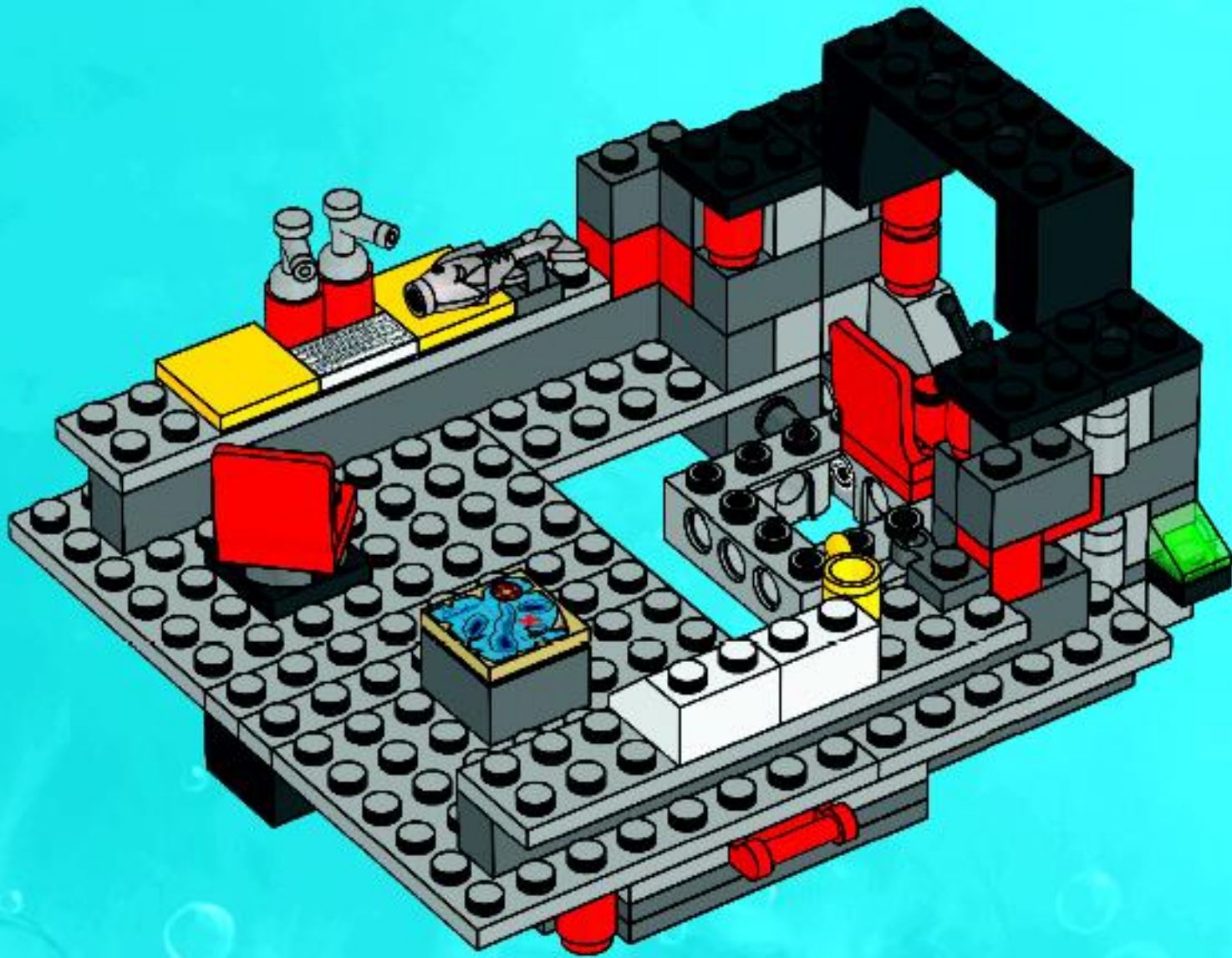



4x



2x

21

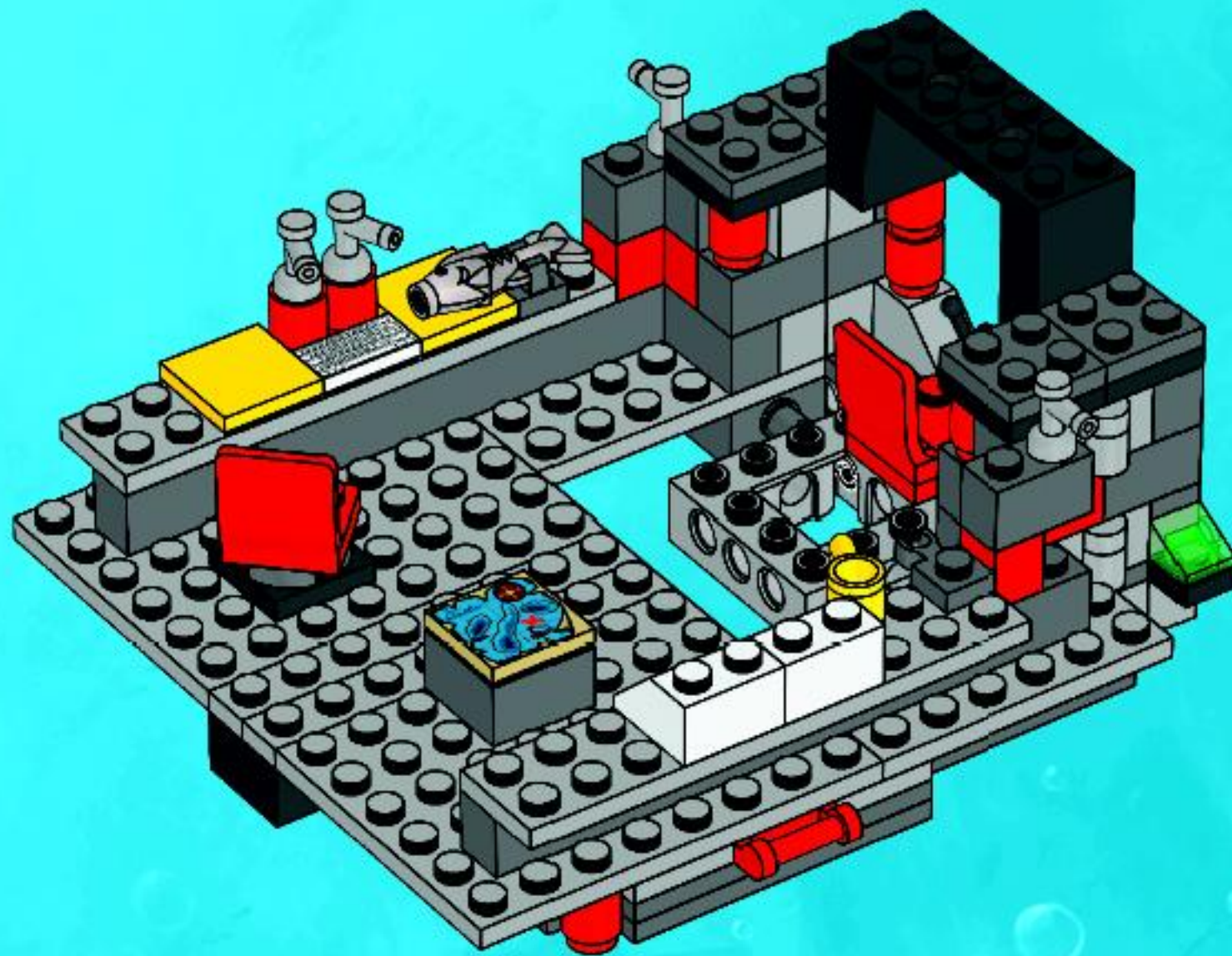



4x

22

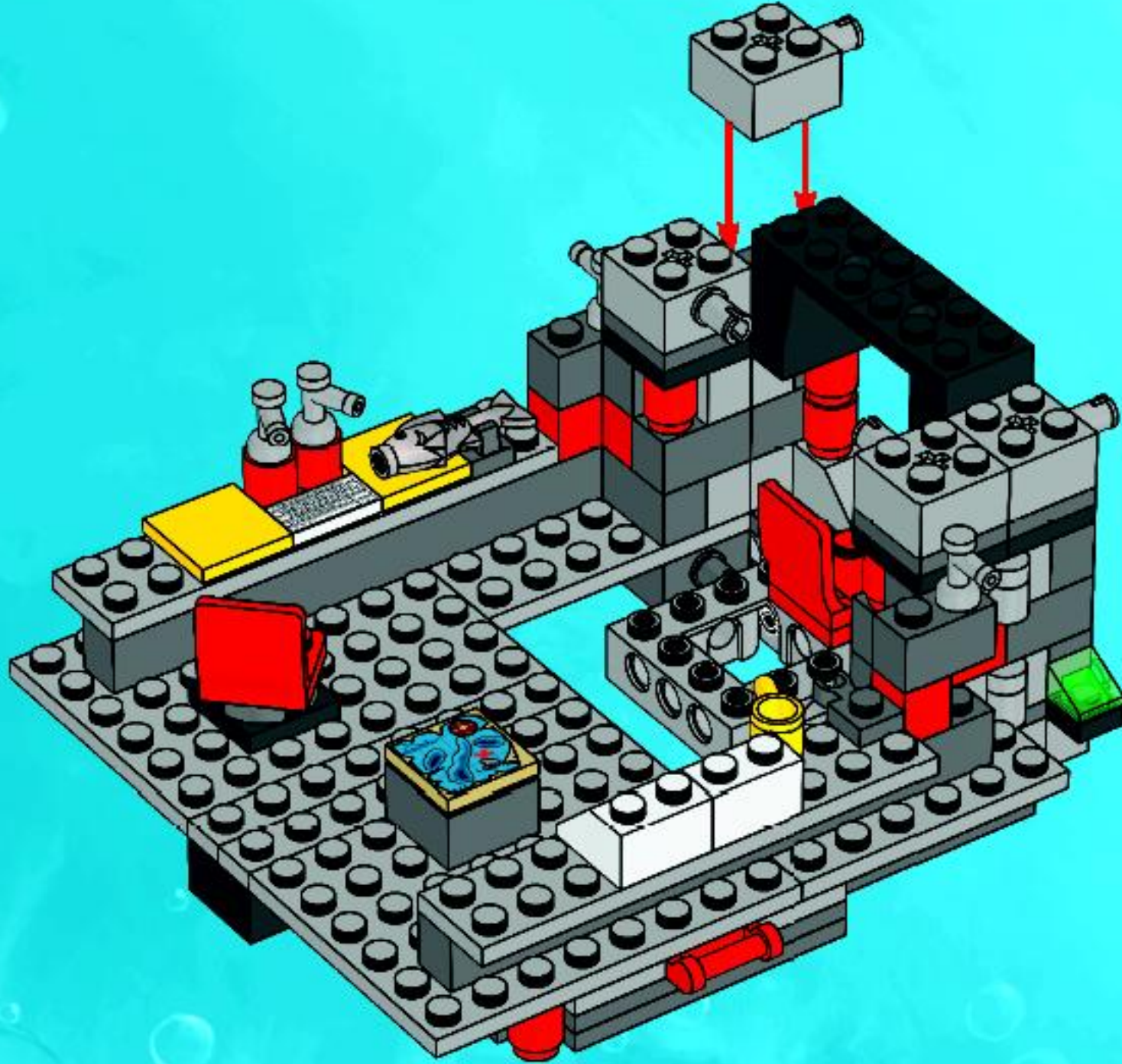

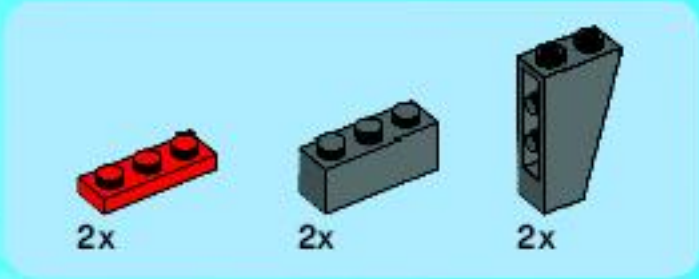

23

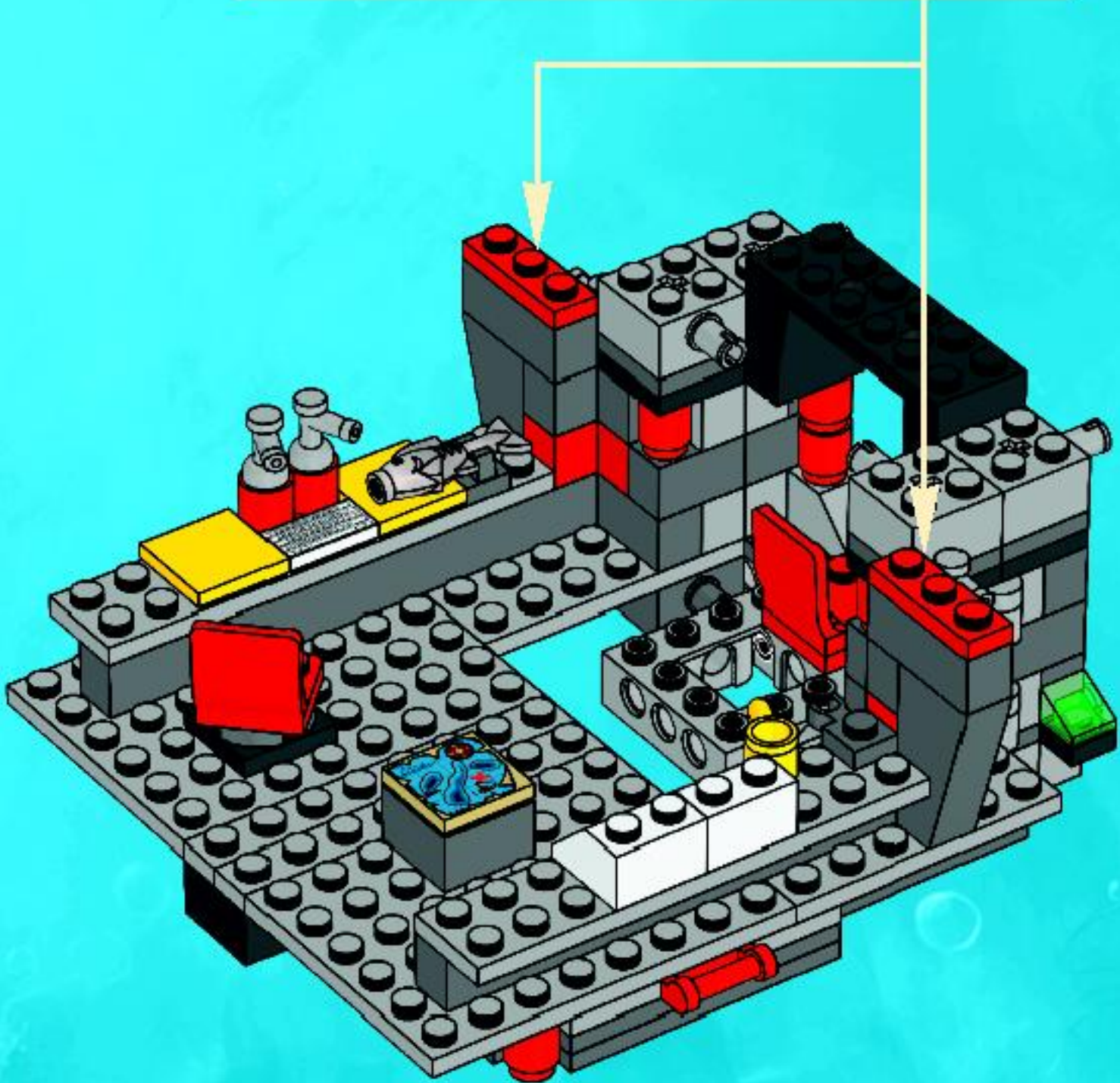
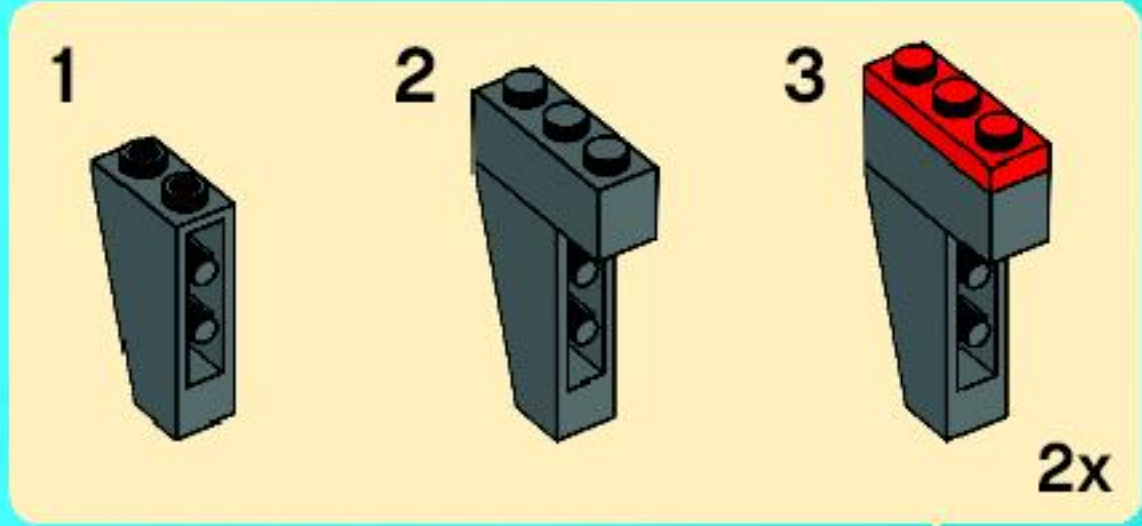

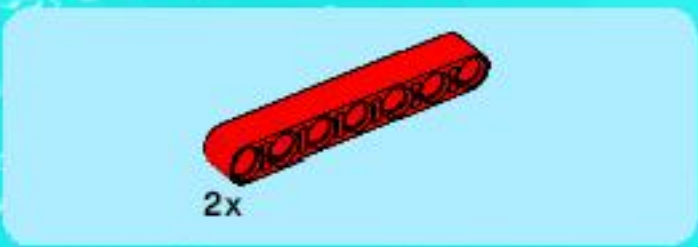

24

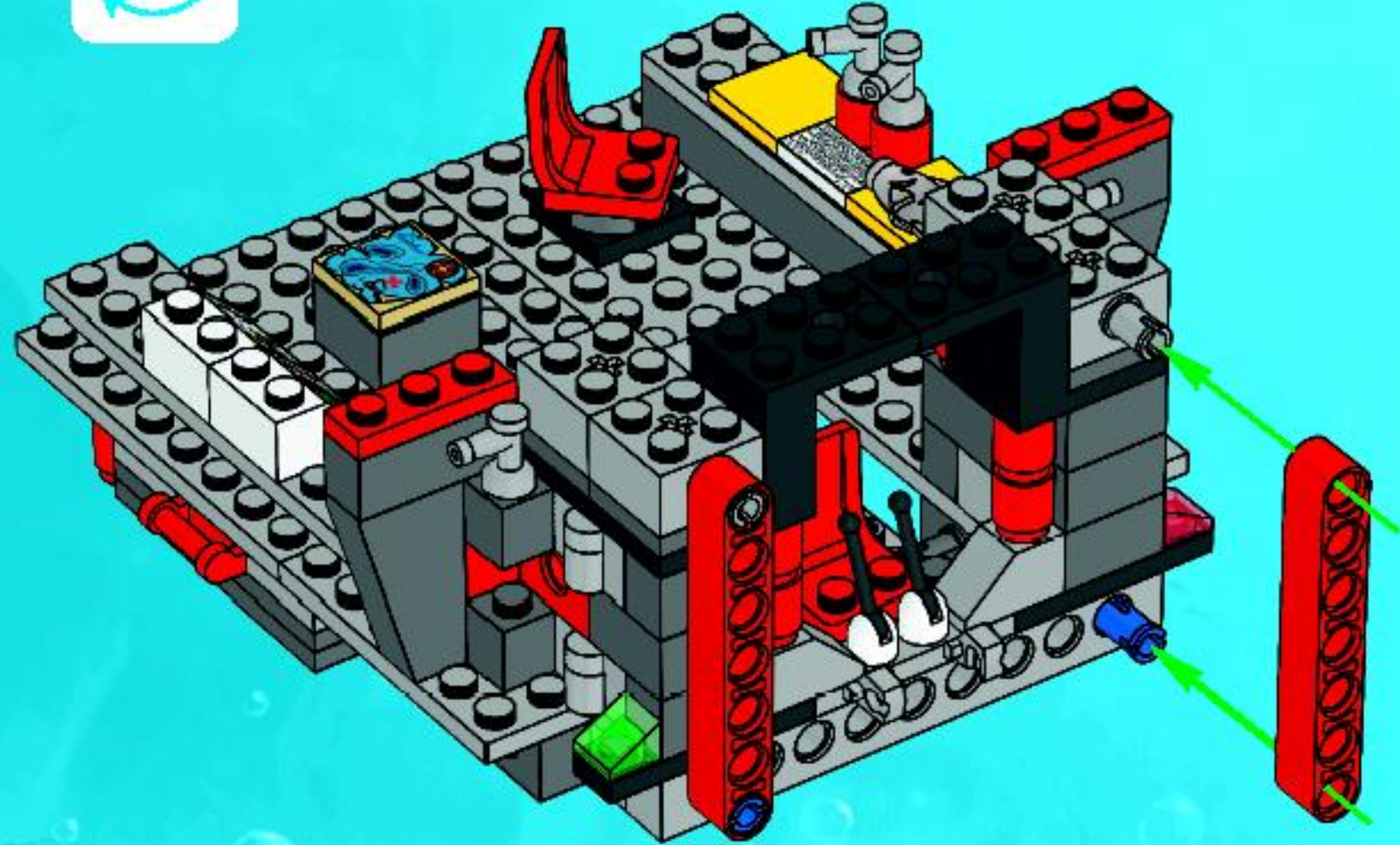



4x

25

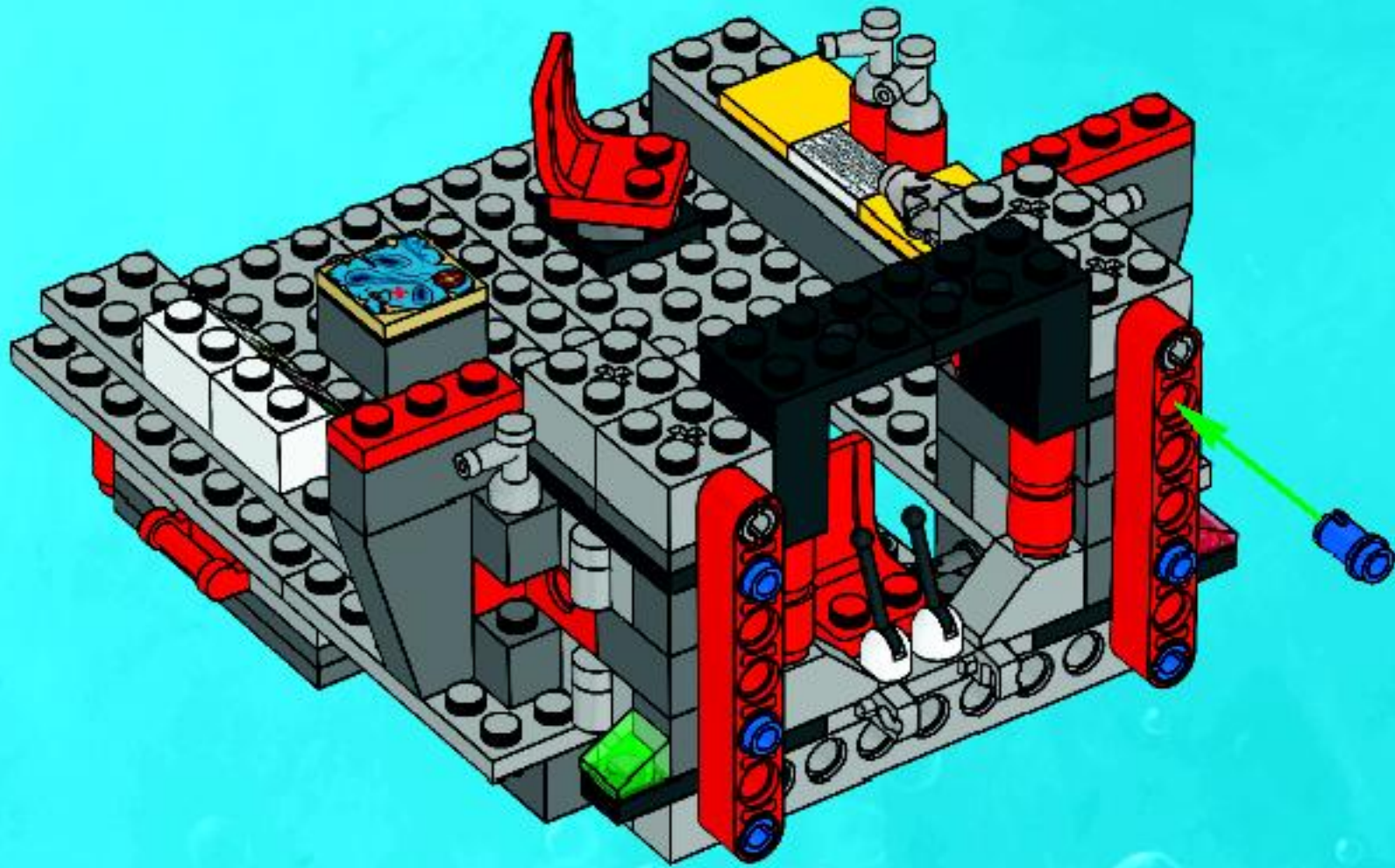

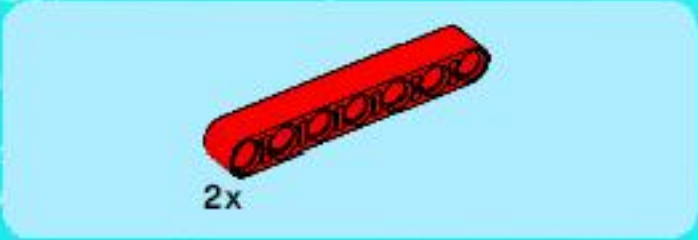

26

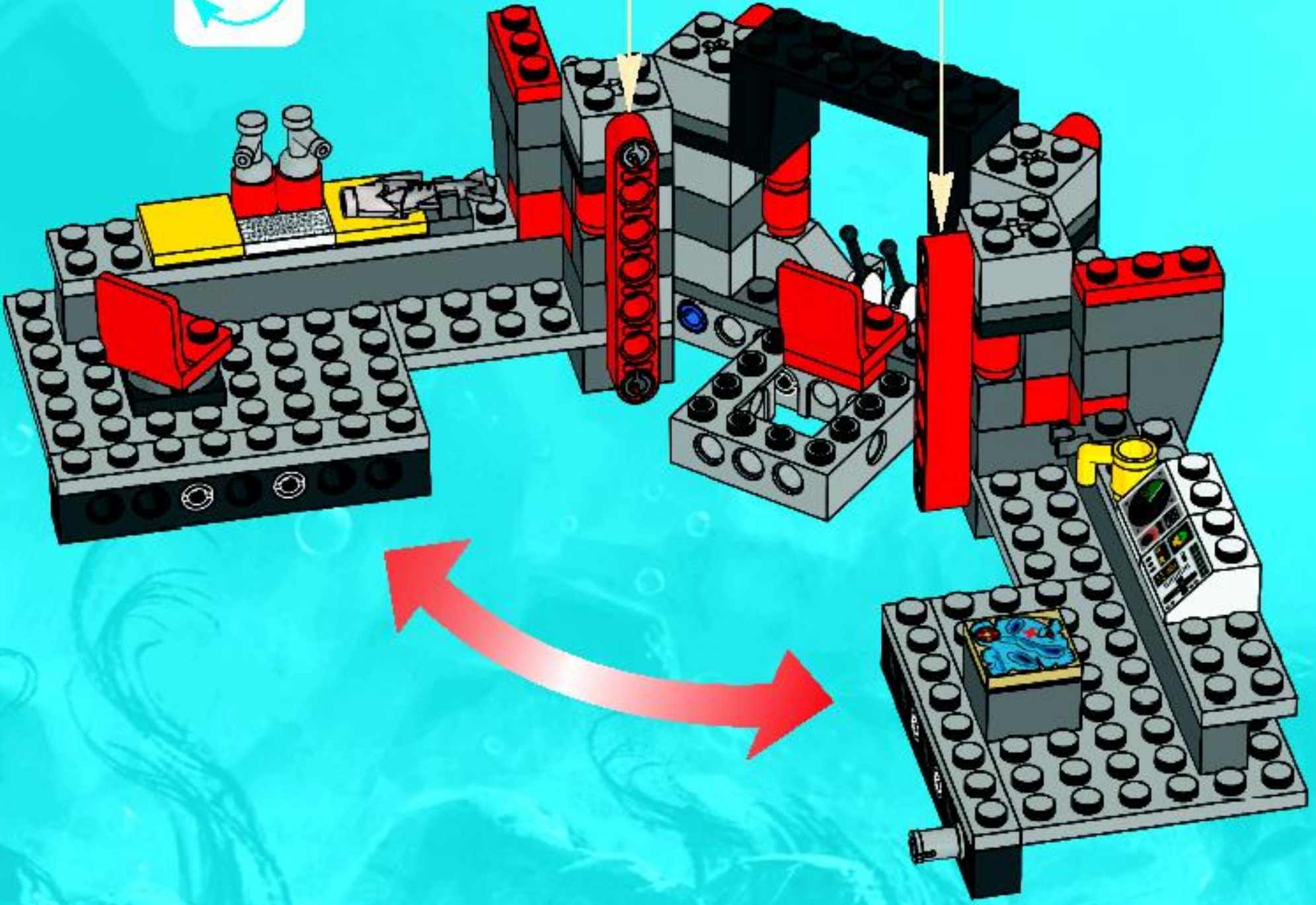
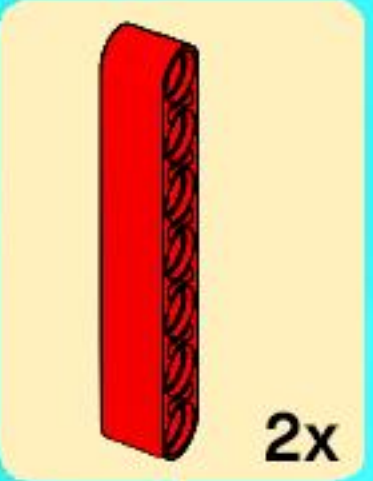

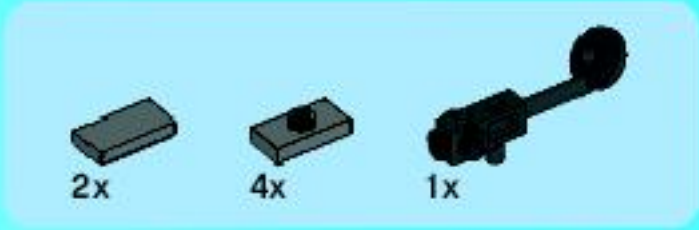

27

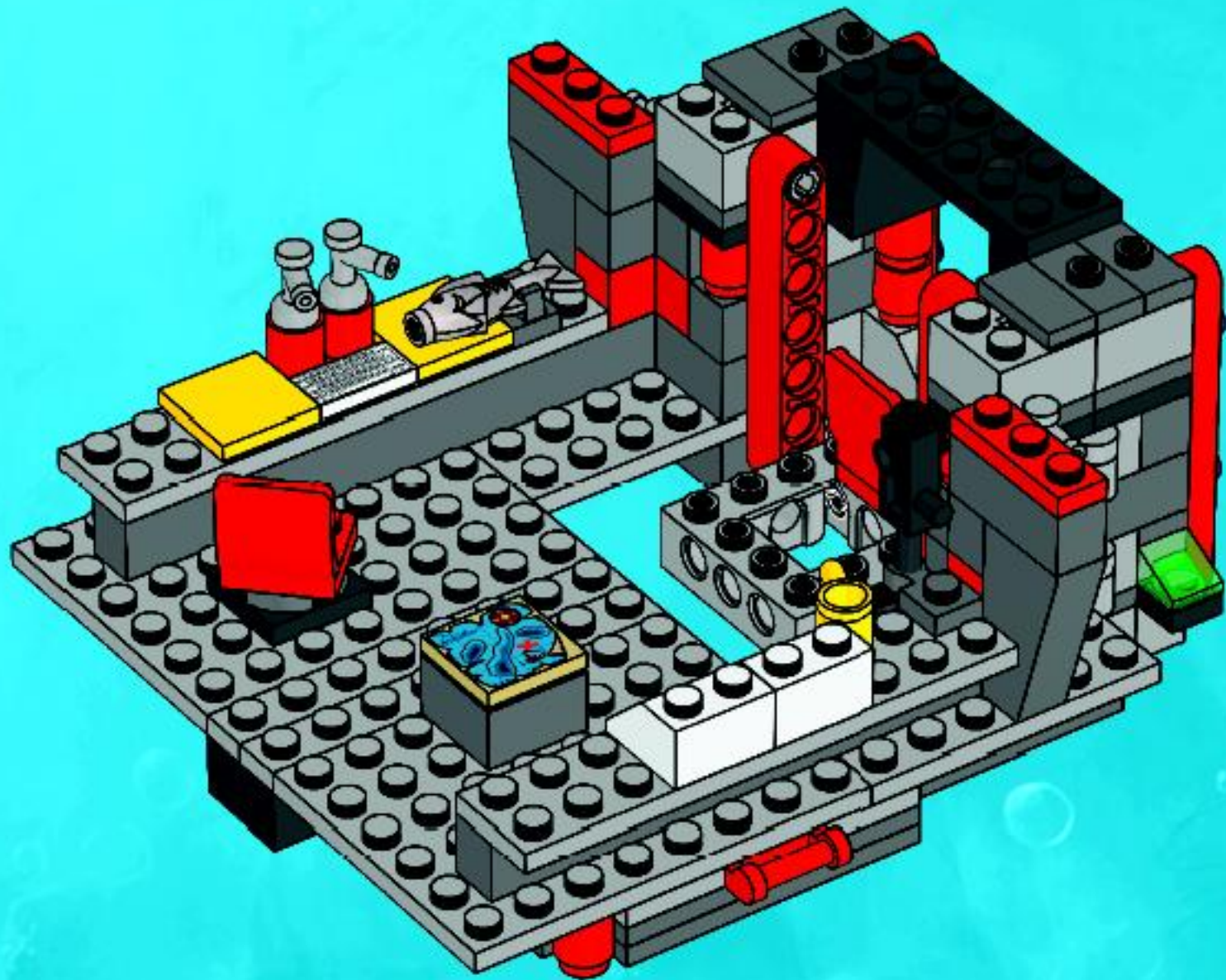

 2x	 2x	 2x
 1x	 1x	 2x

28

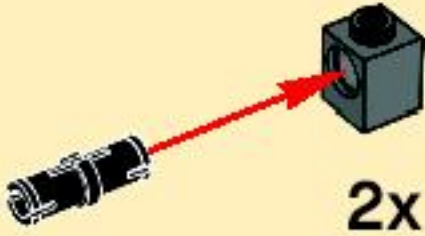

2x

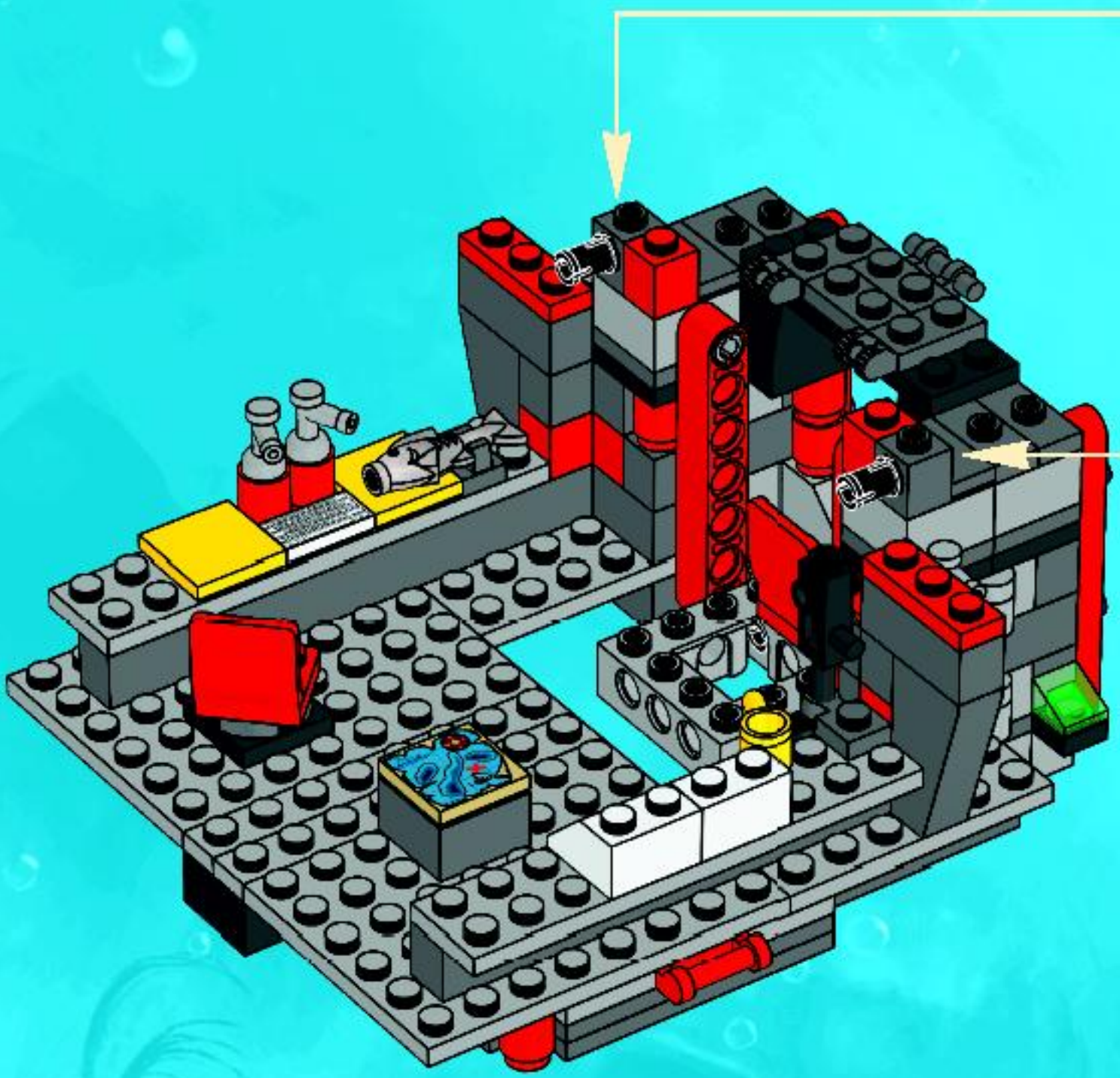



2x





4x

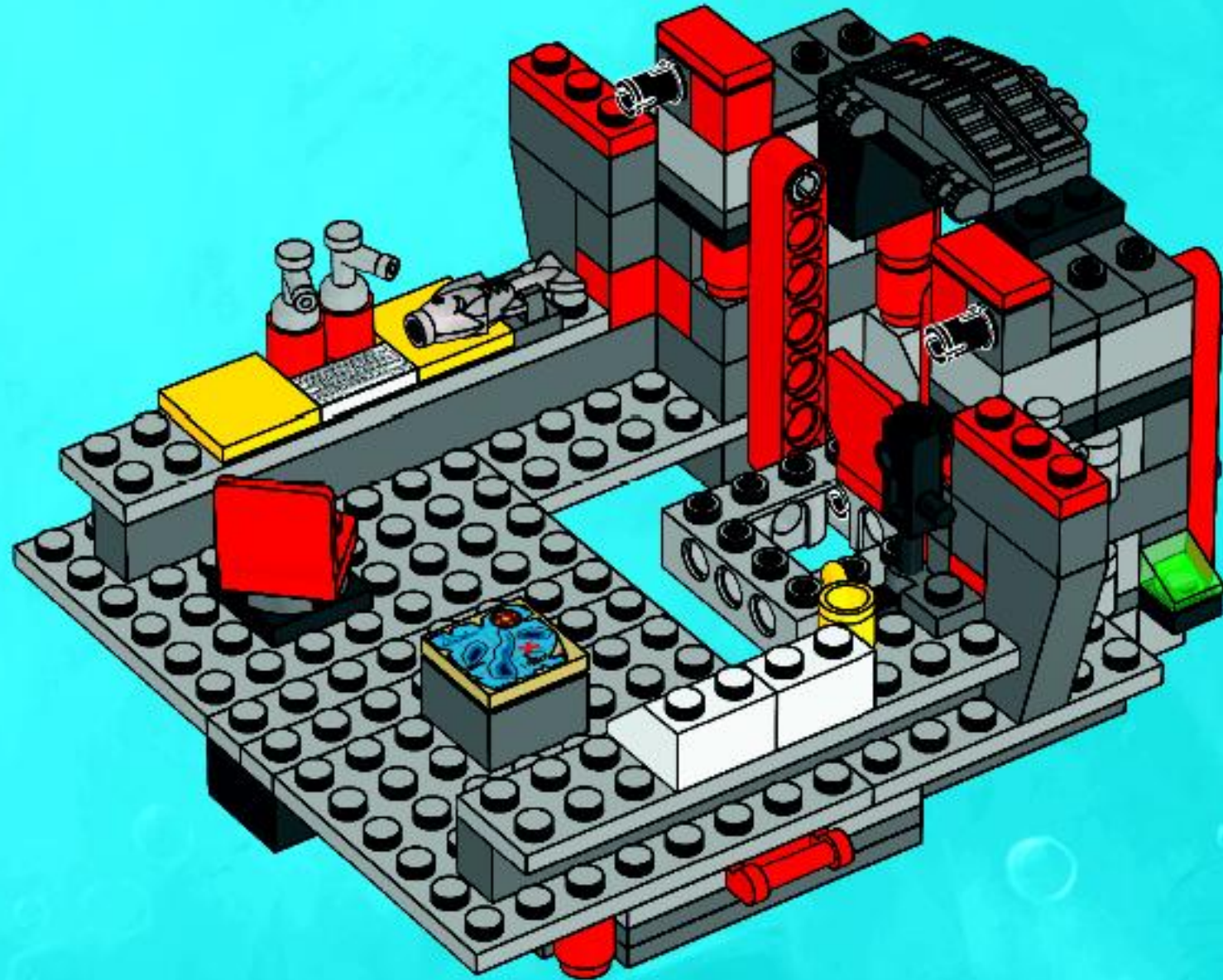

29

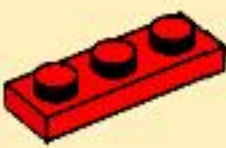
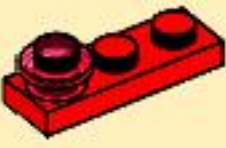

 2x
  1x
  1x
  2x

30

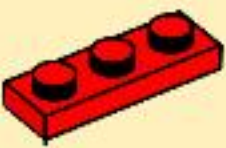
- 1 
- 2 
- 3 

- 1 
- 2 
- 3 

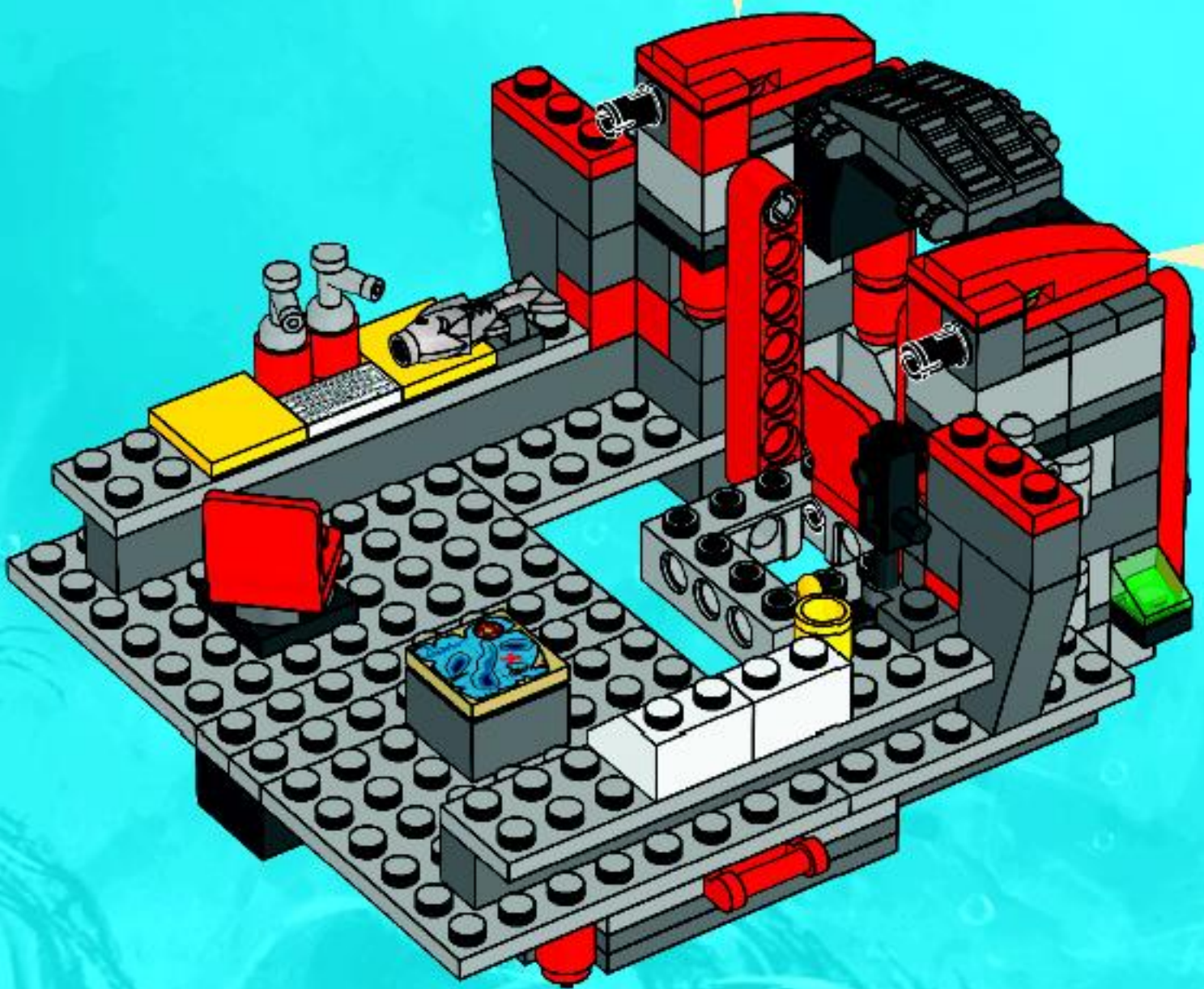

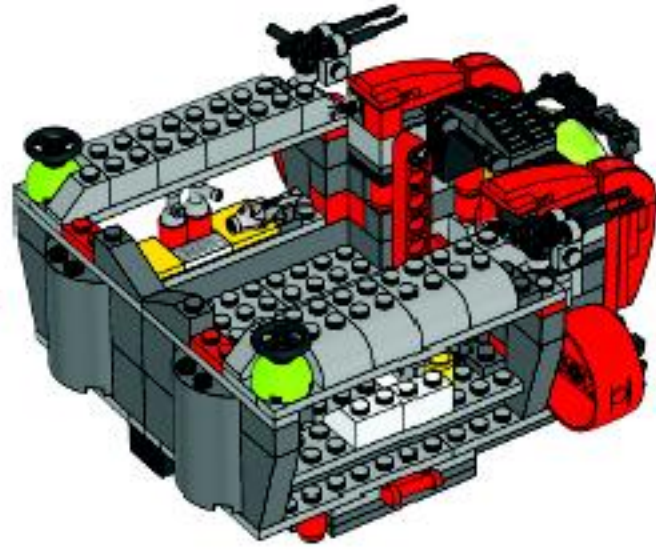

2x



2x

31

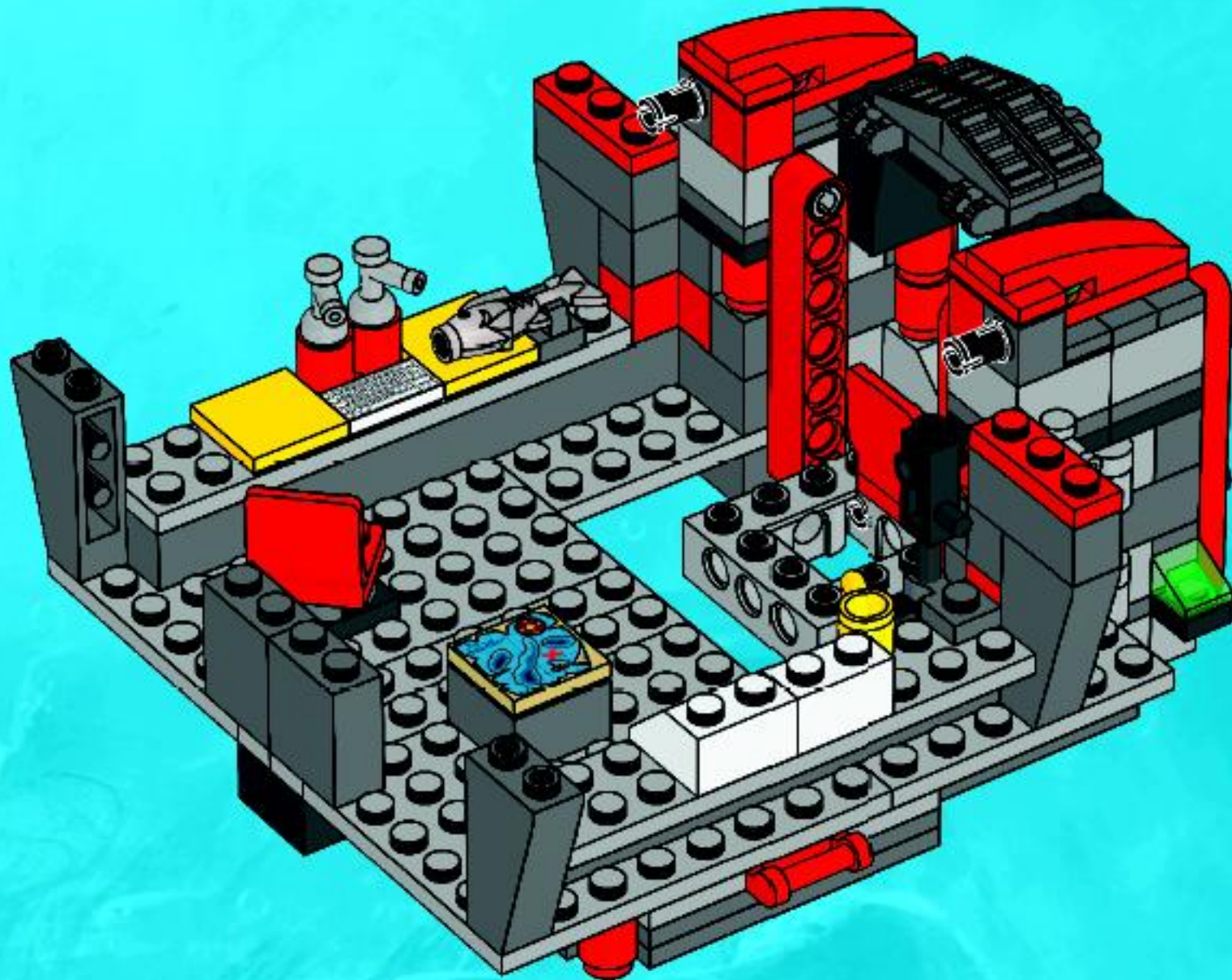



2x



2x

32

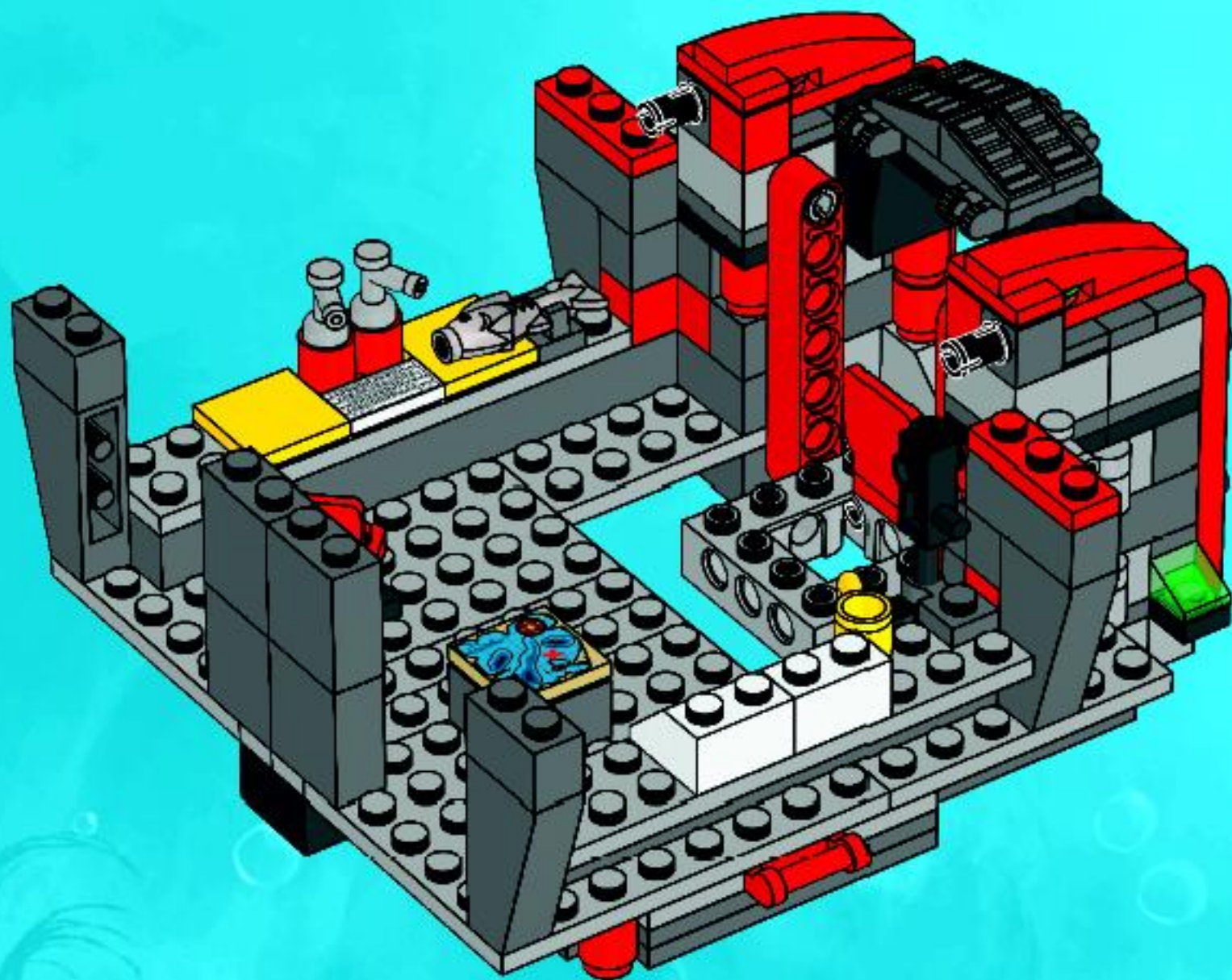



2x

33

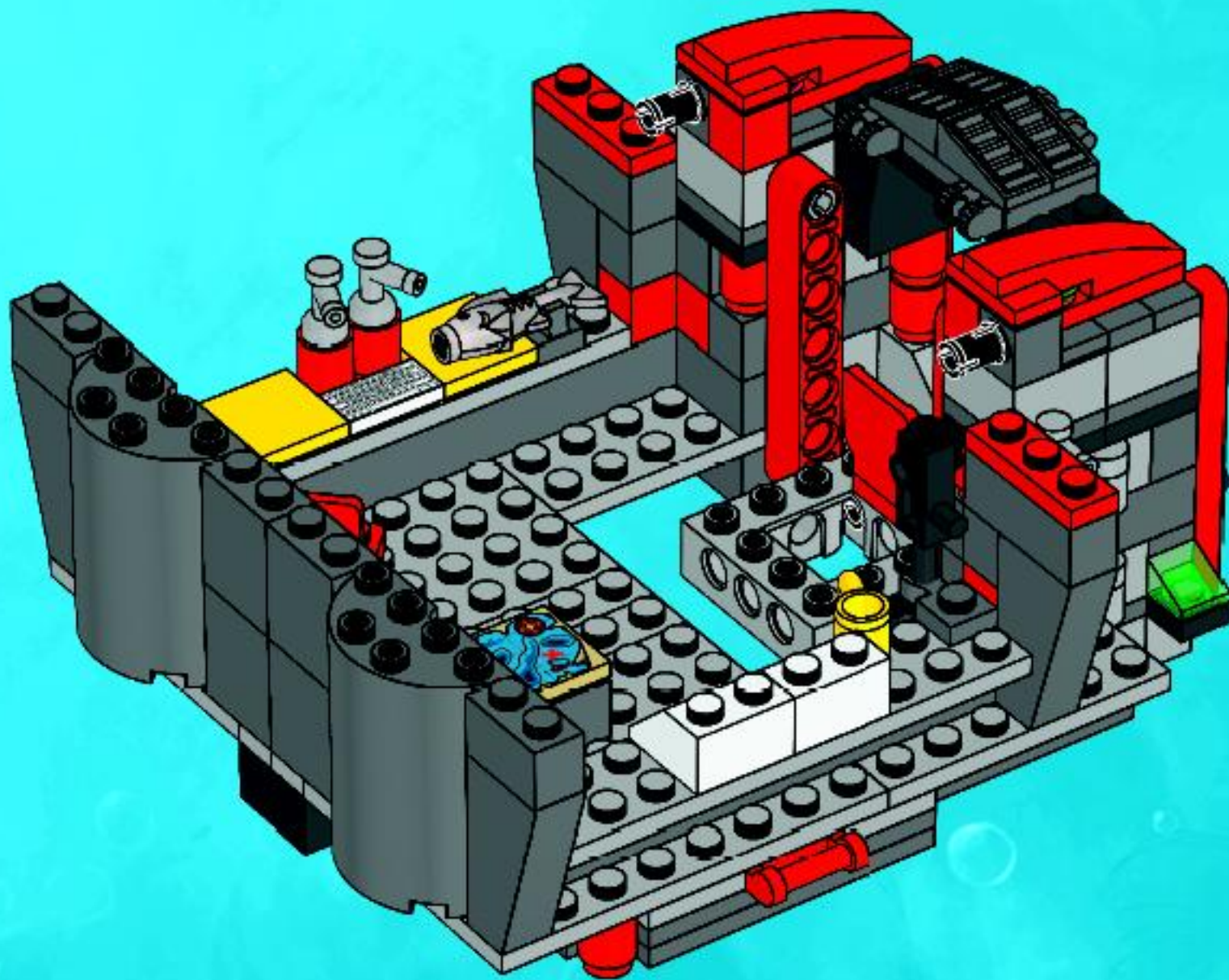

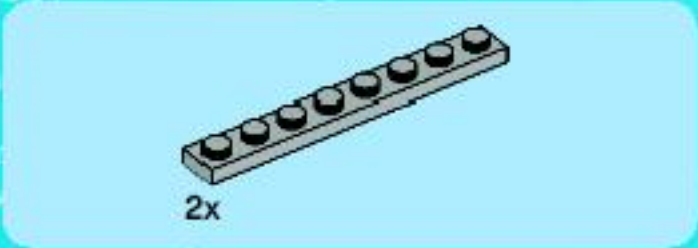

34

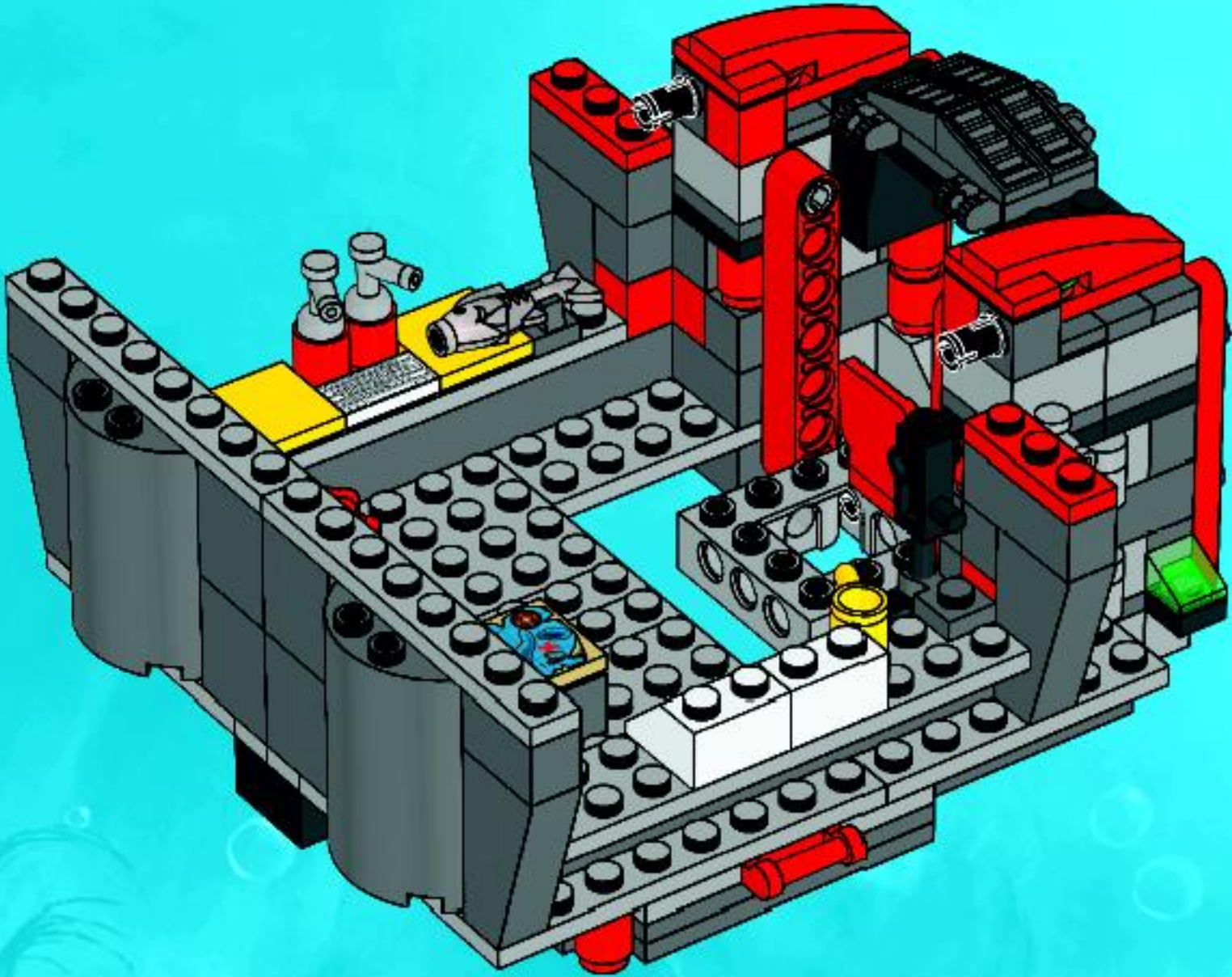



2x



2x

35

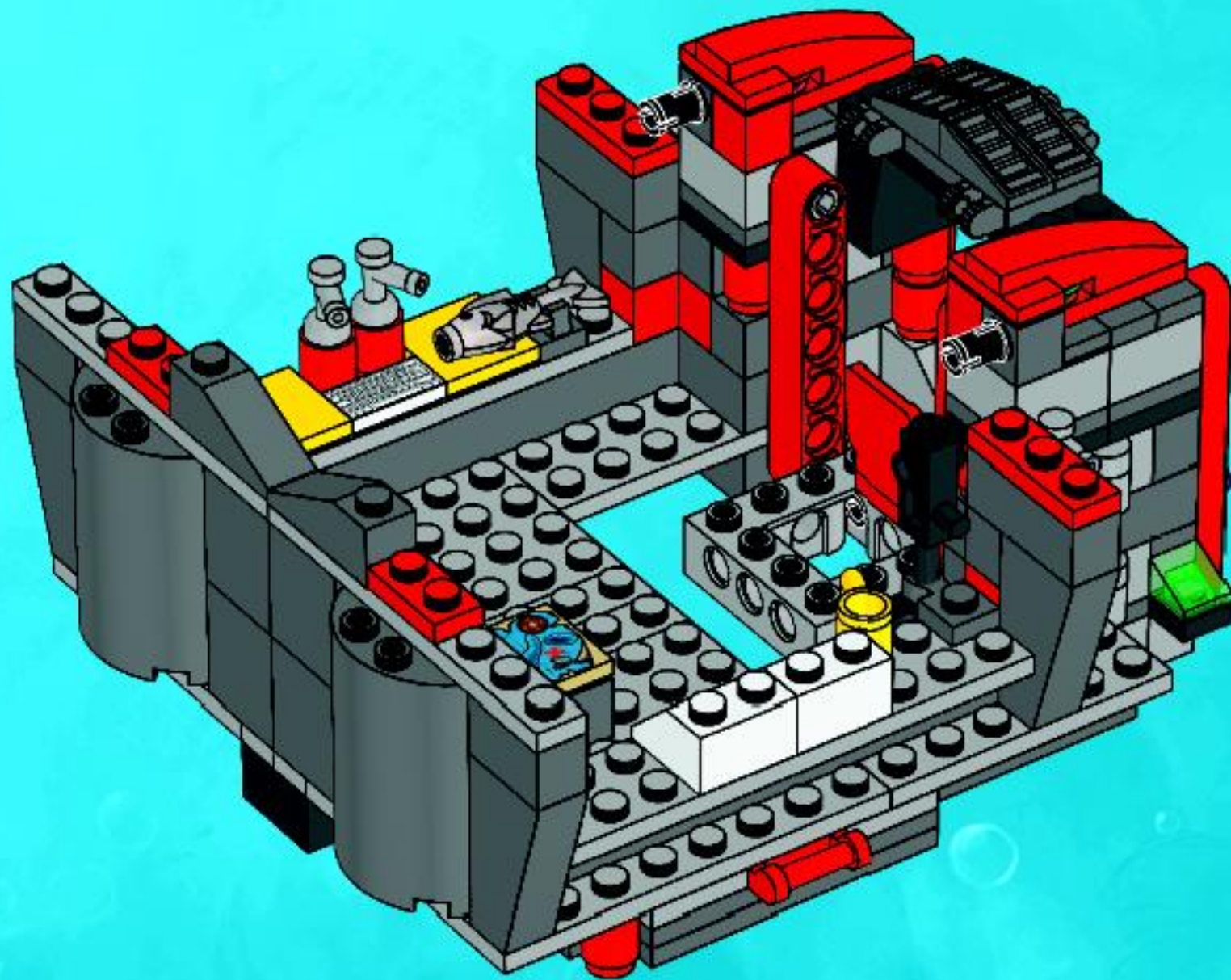

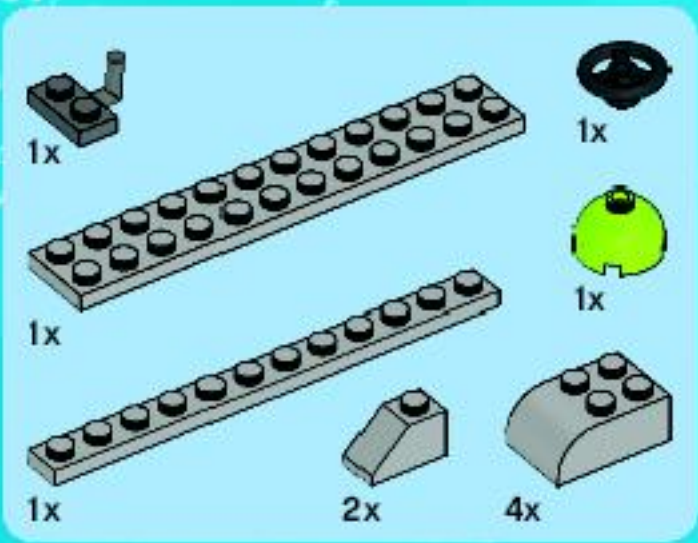

36

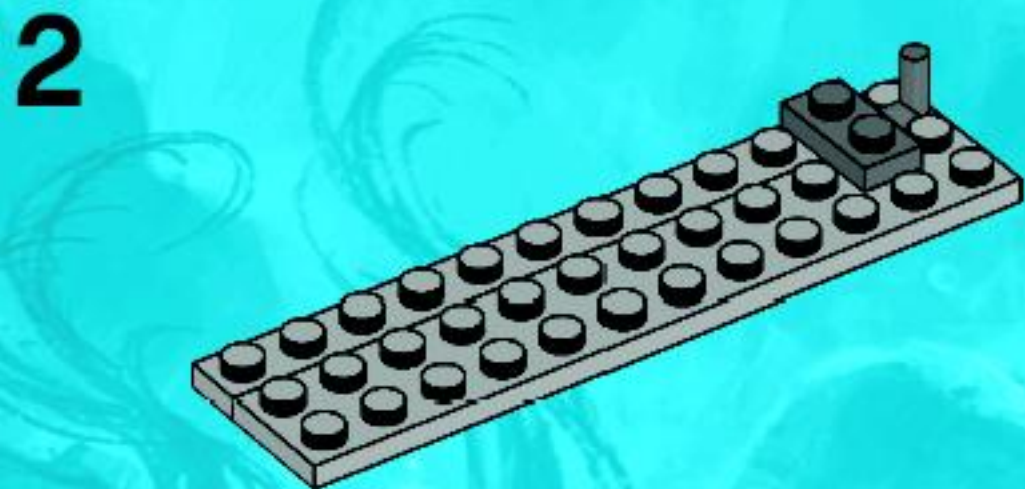
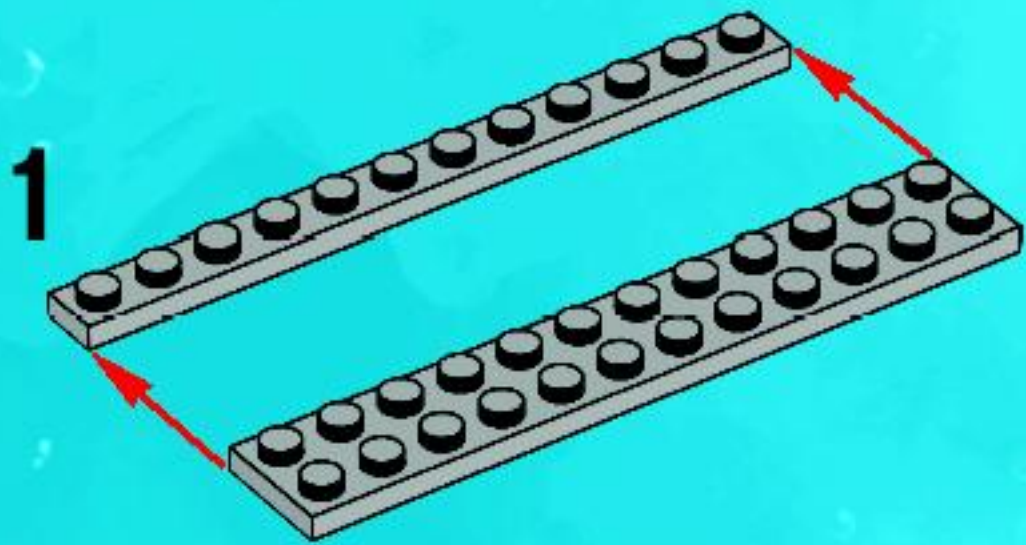

3

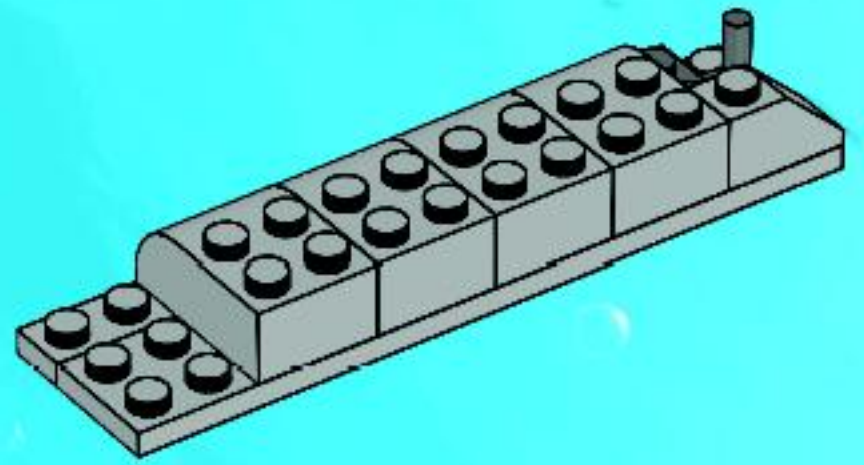

4

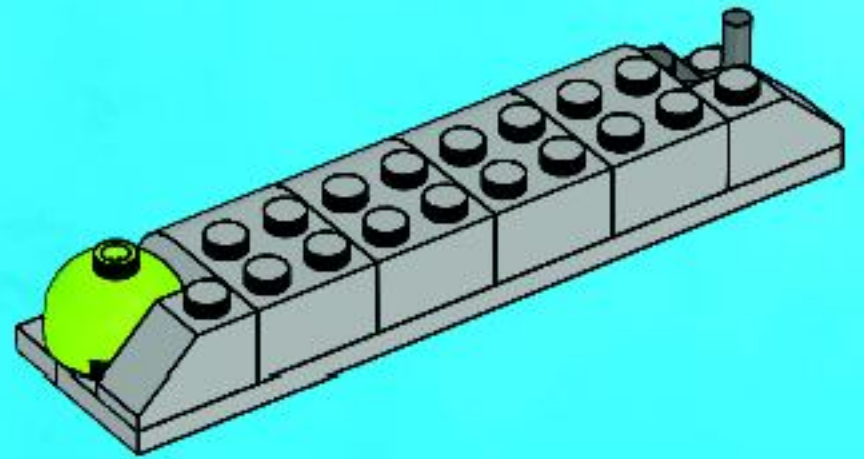

5

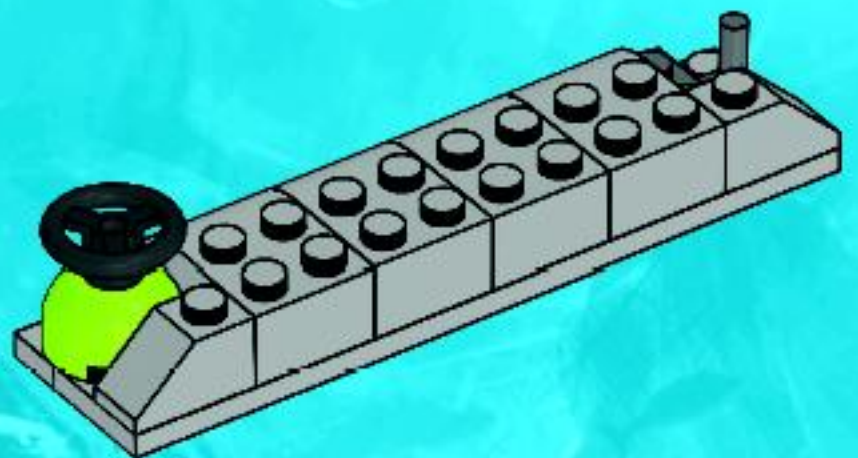

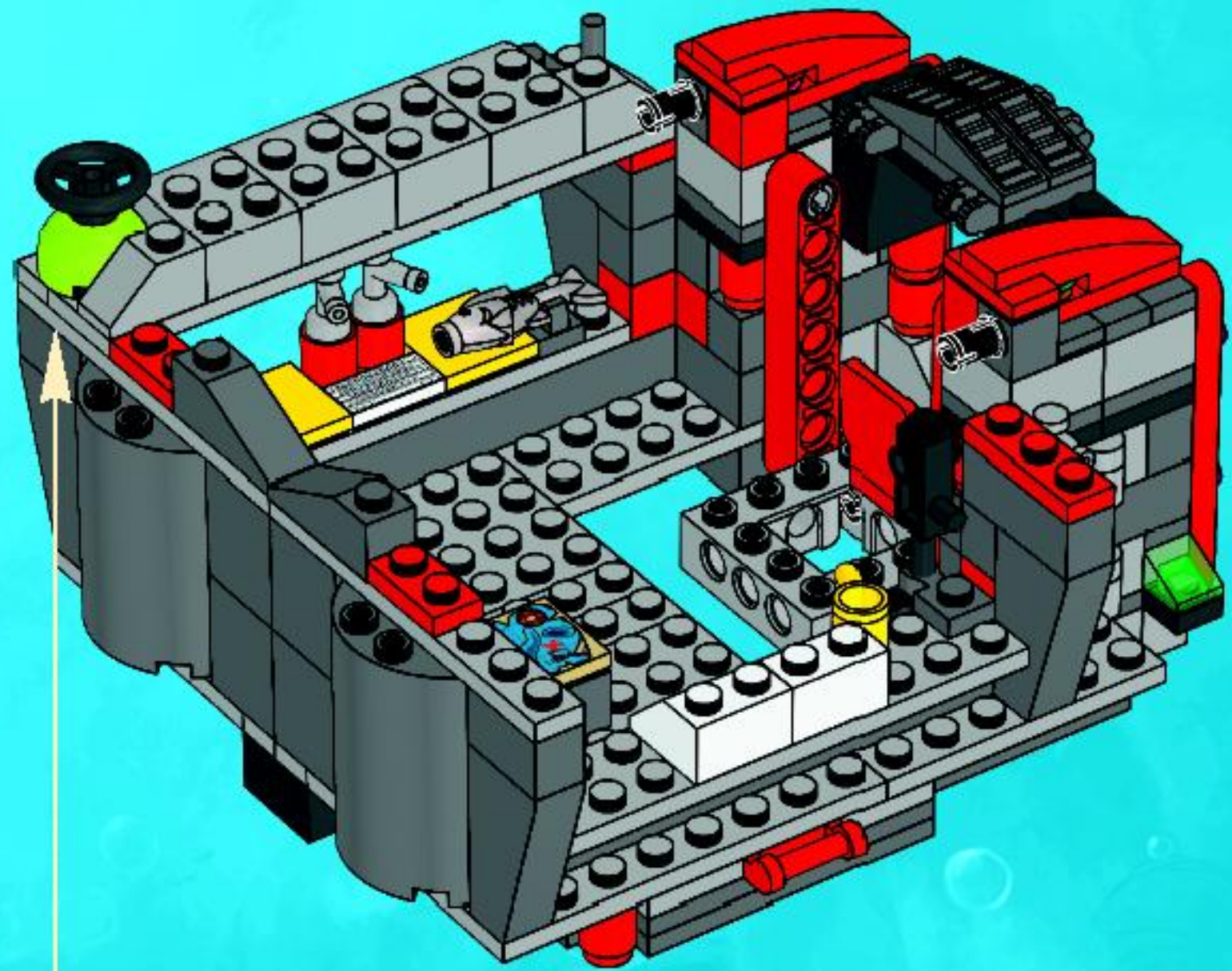

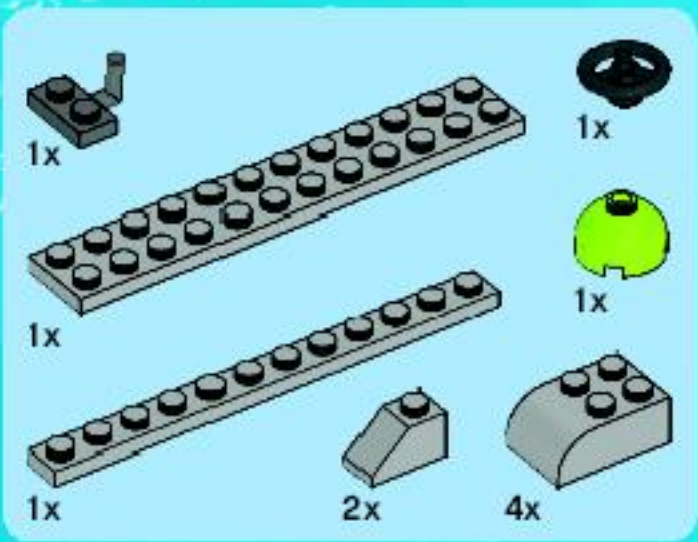

37

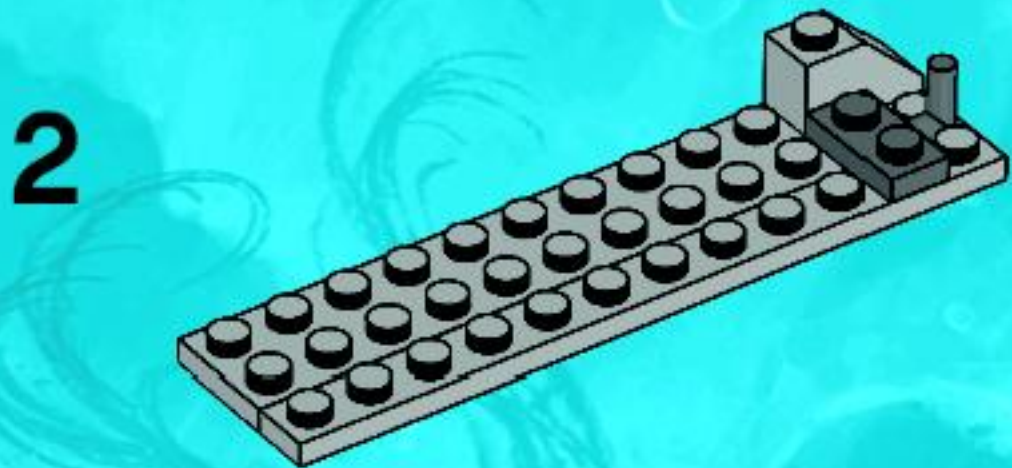
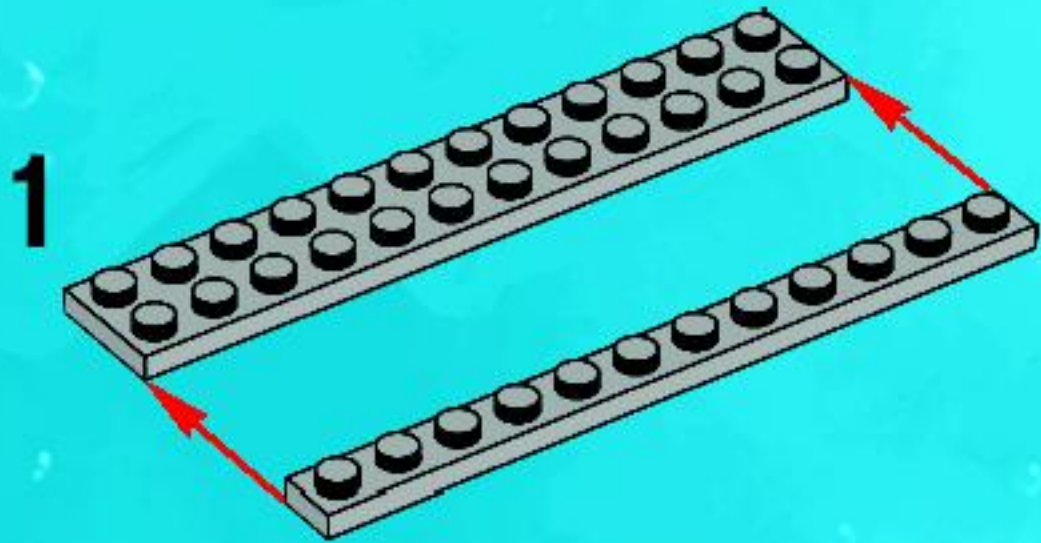

3

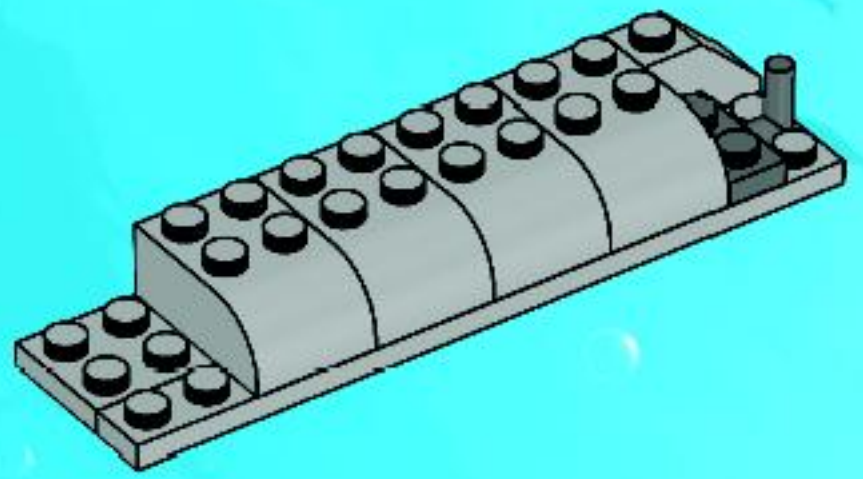

4

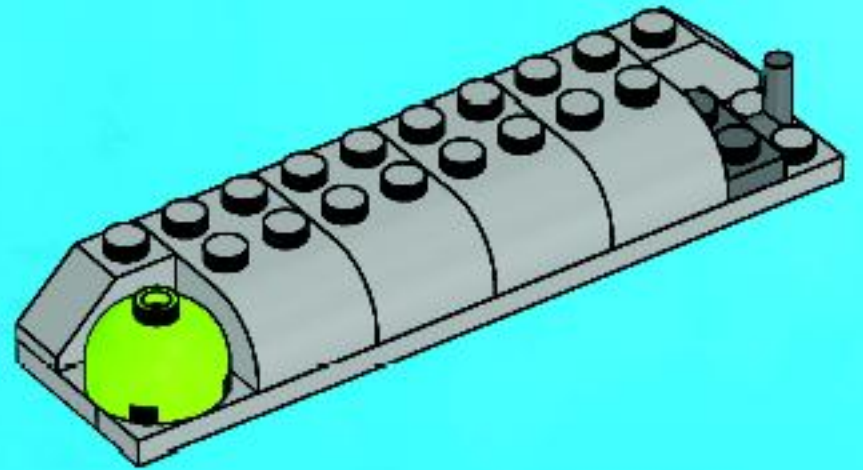

5

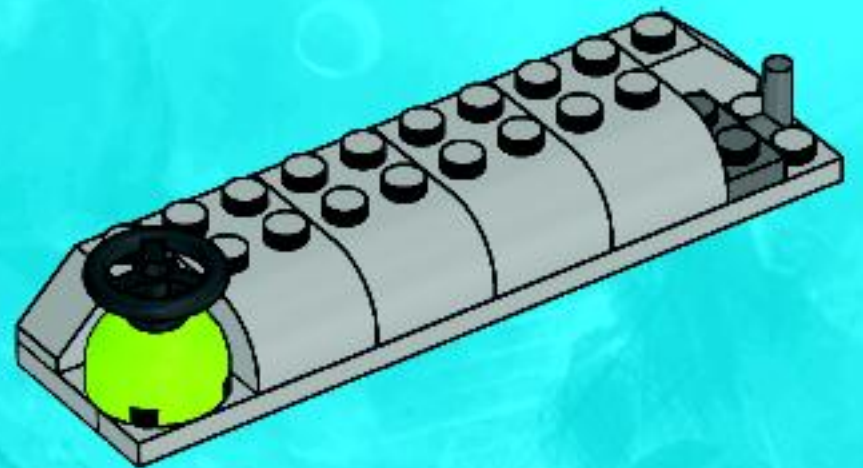

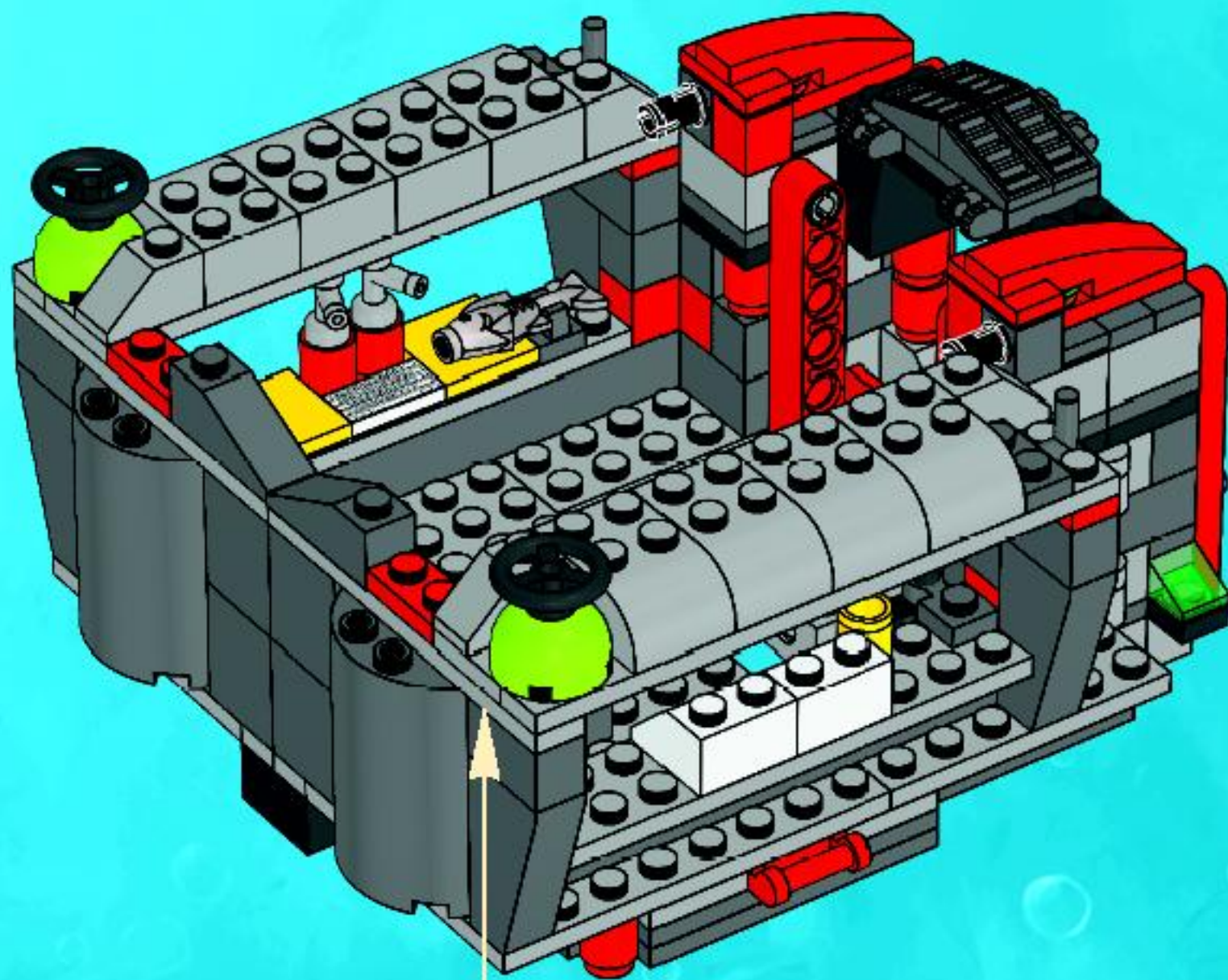

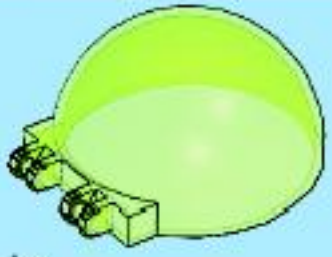

1x

38

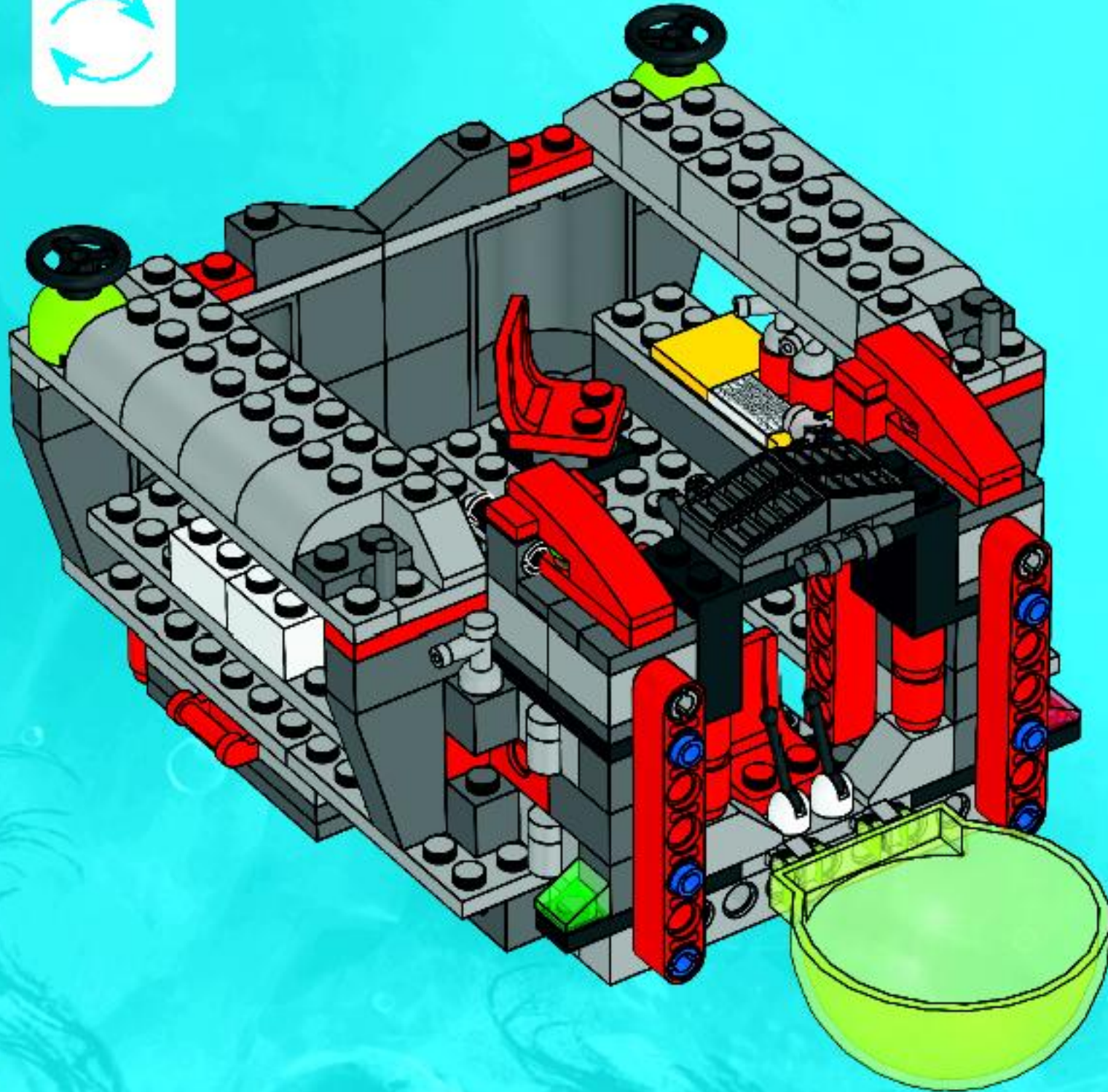

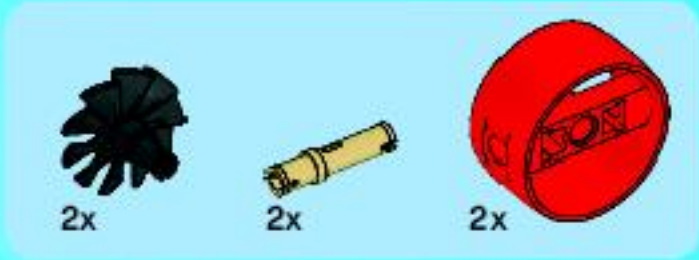

39

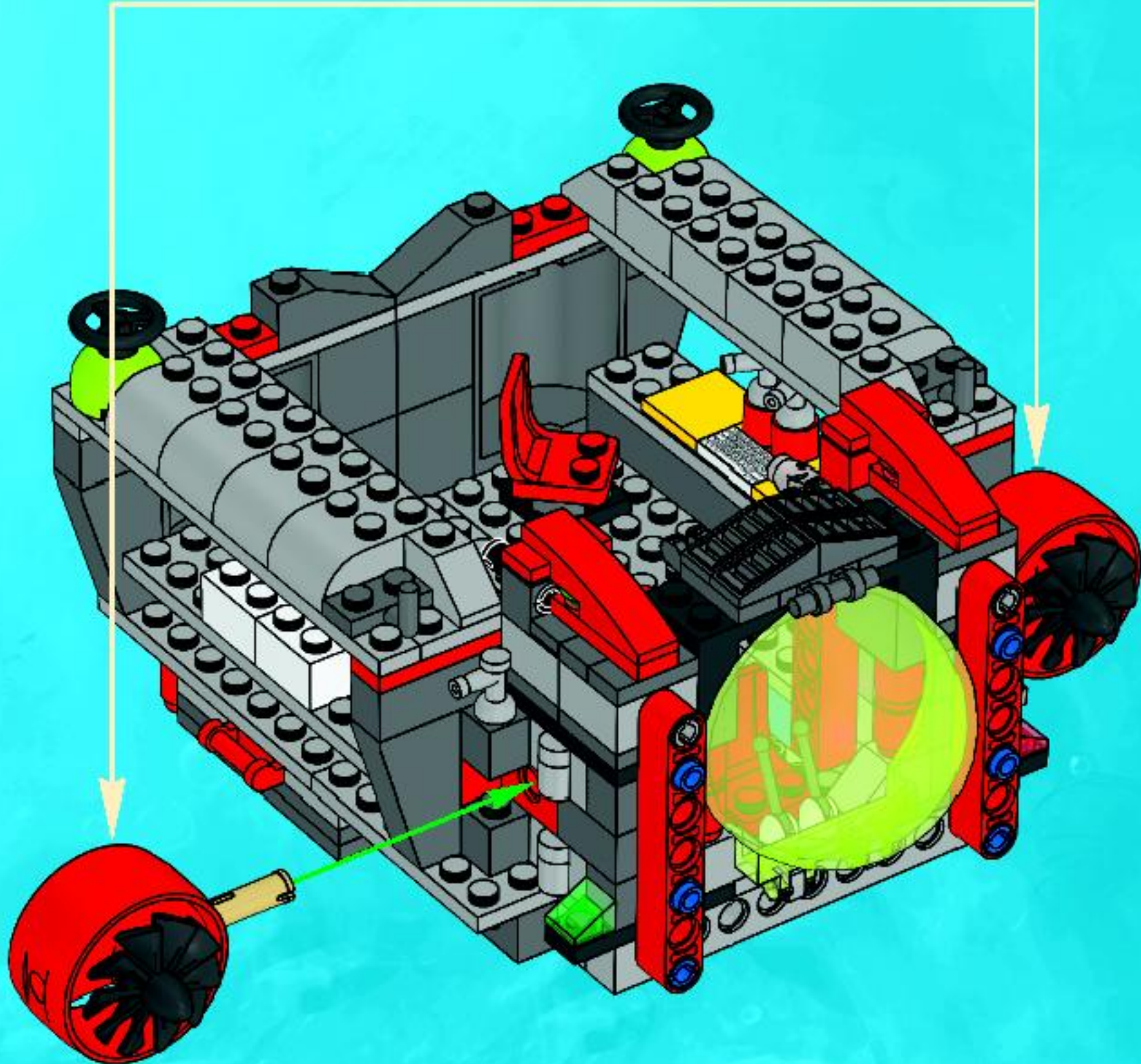
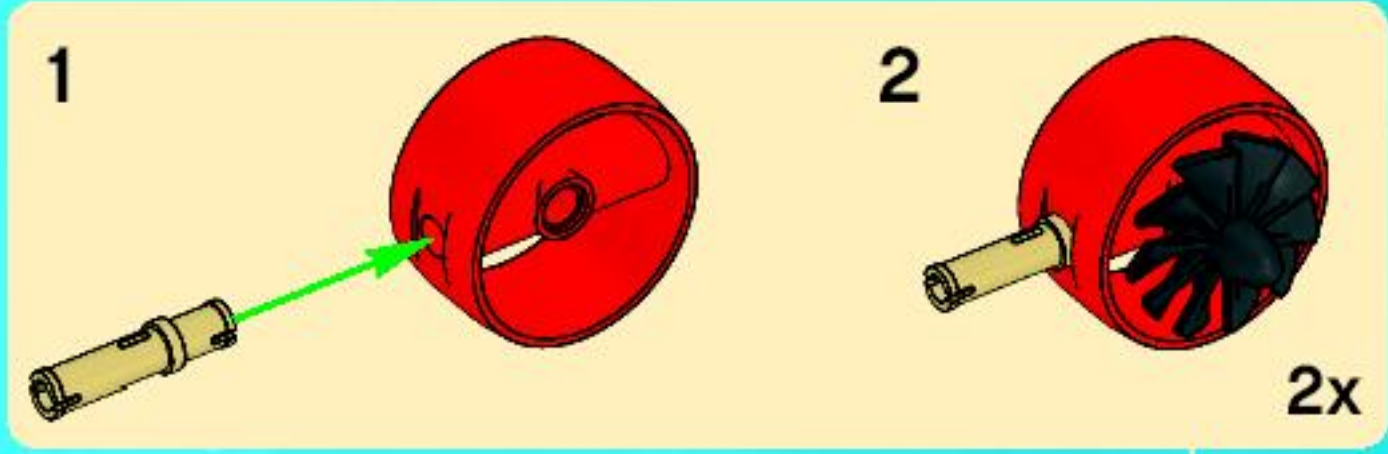

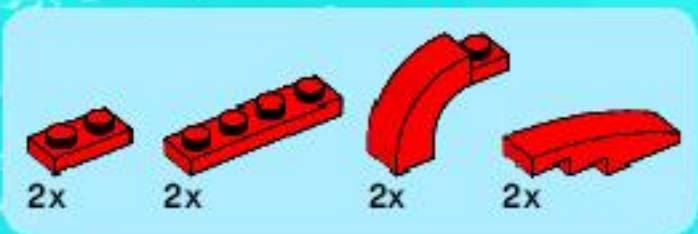

40

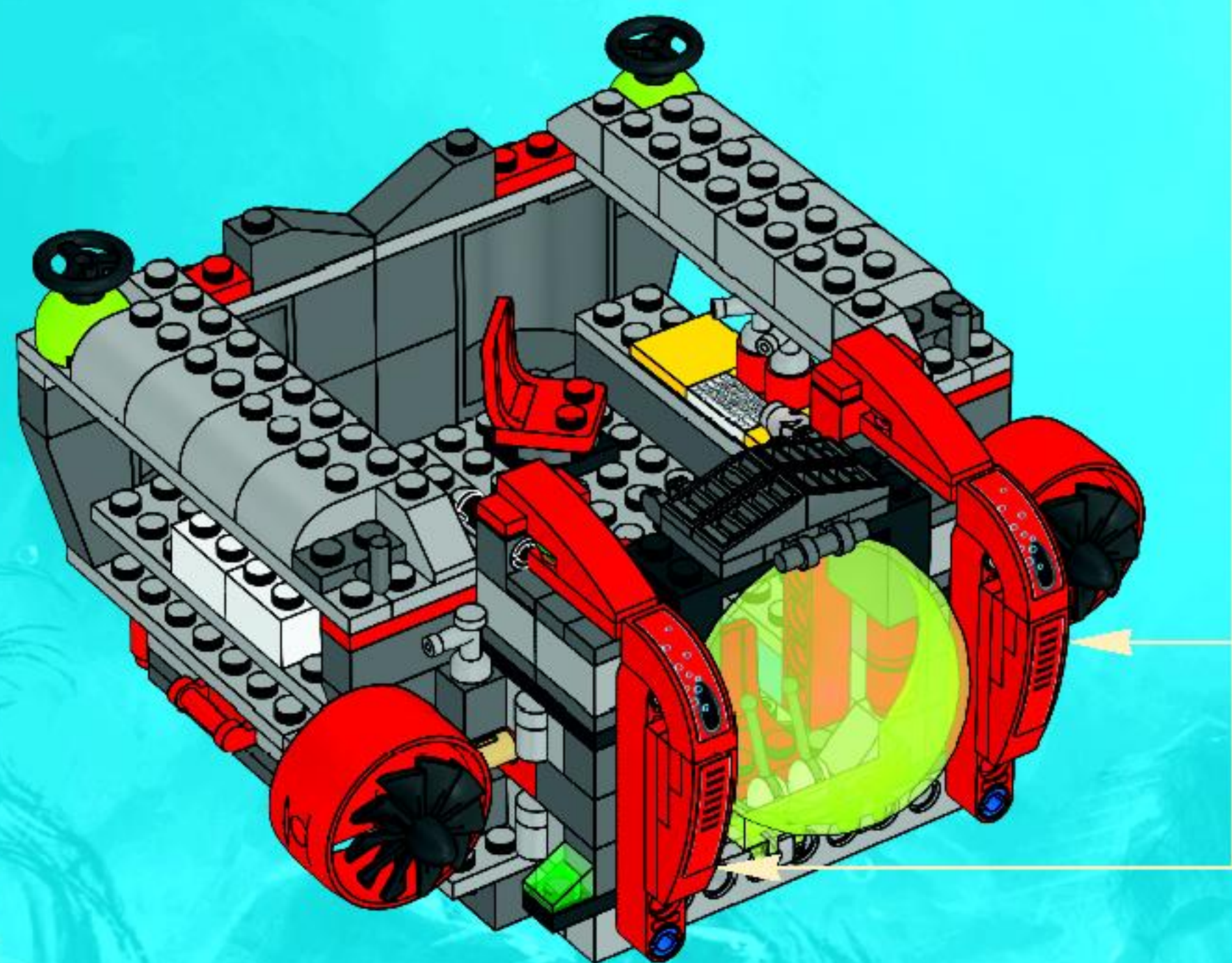
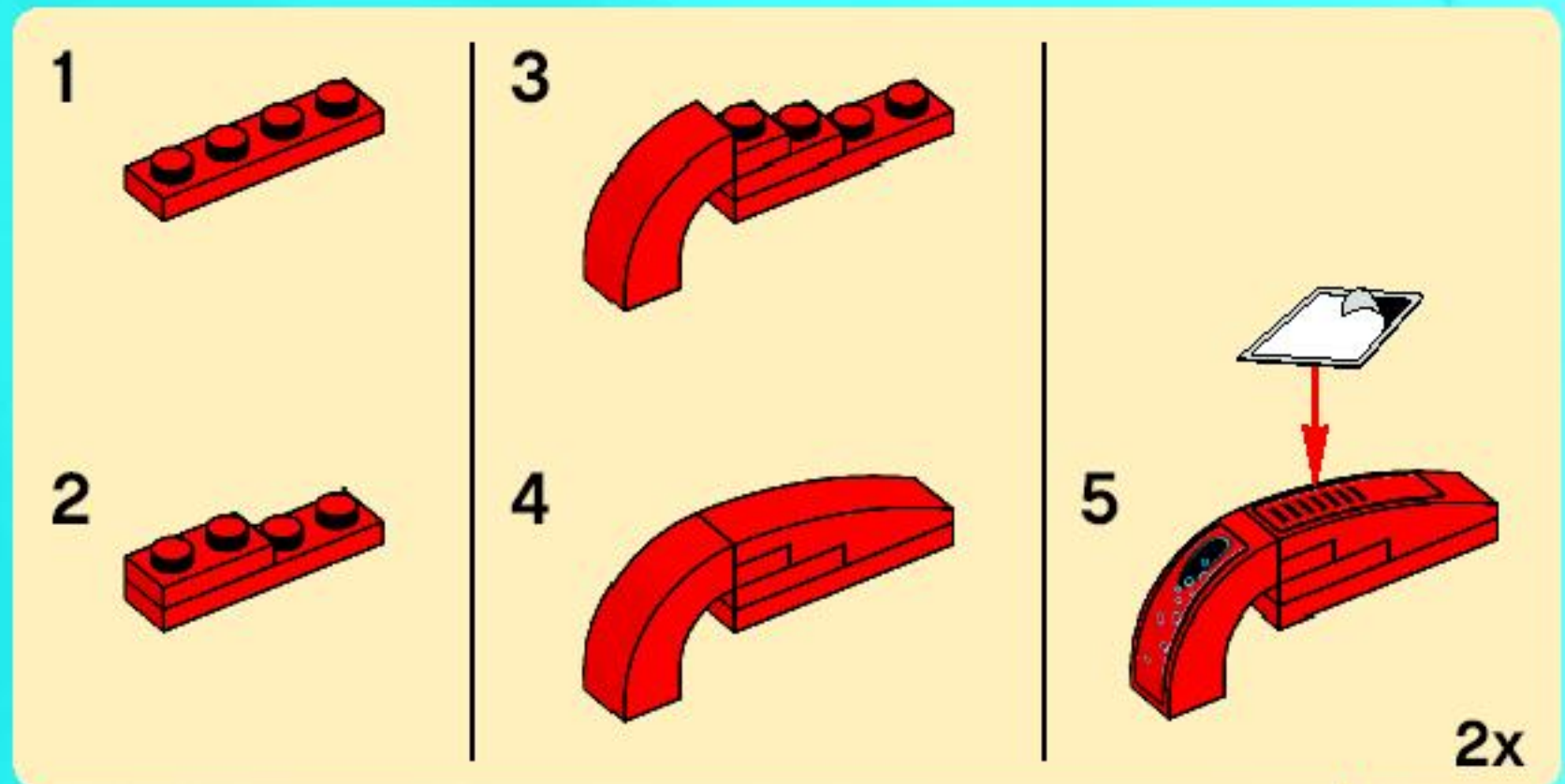



41



3



4



5



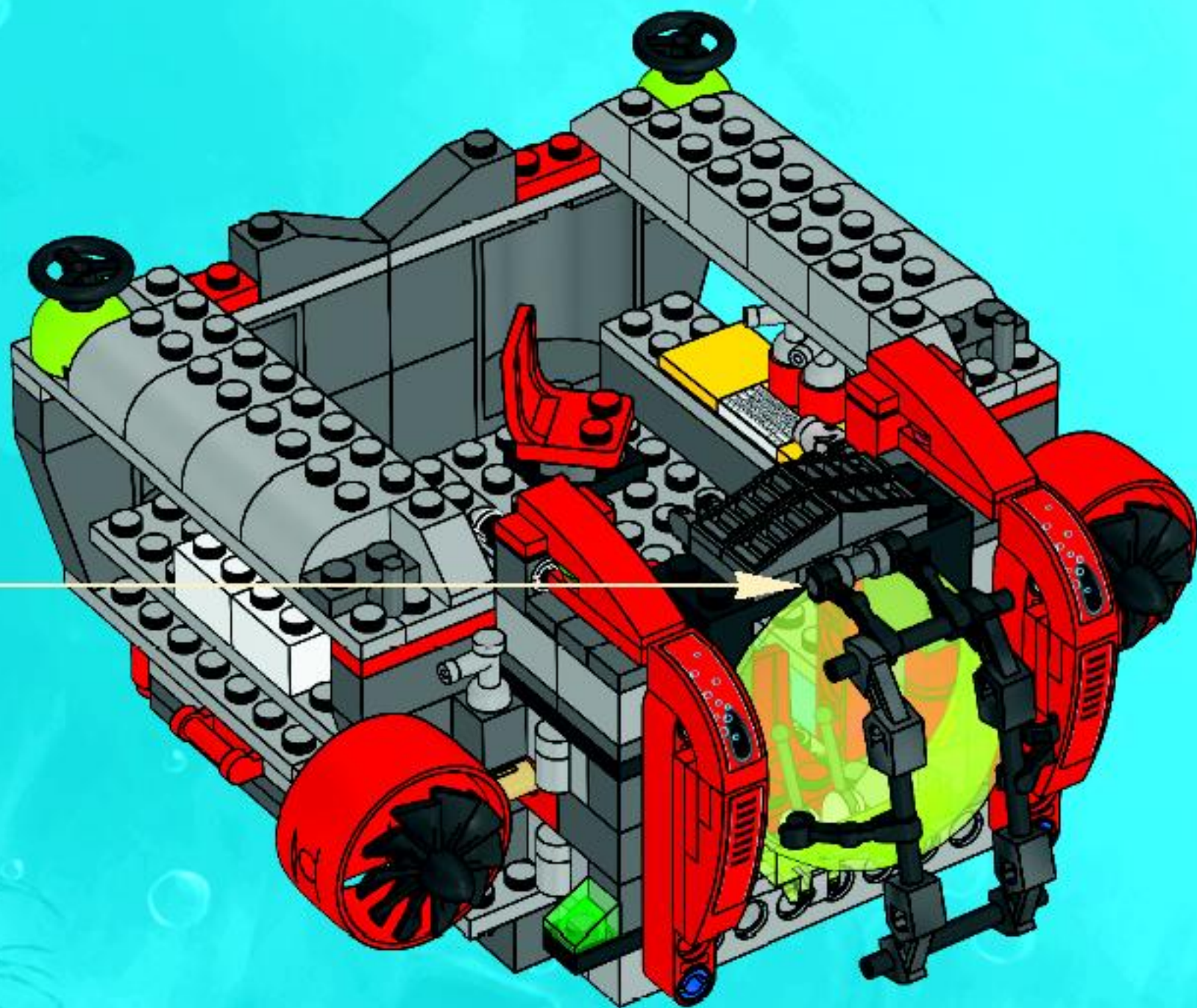

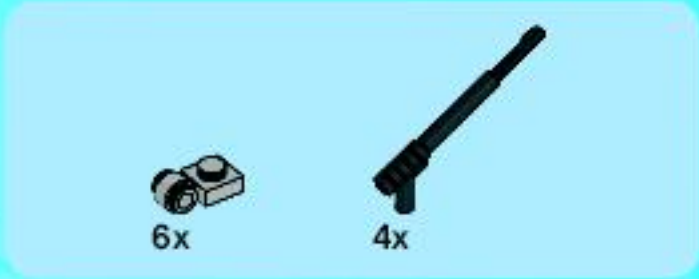

42

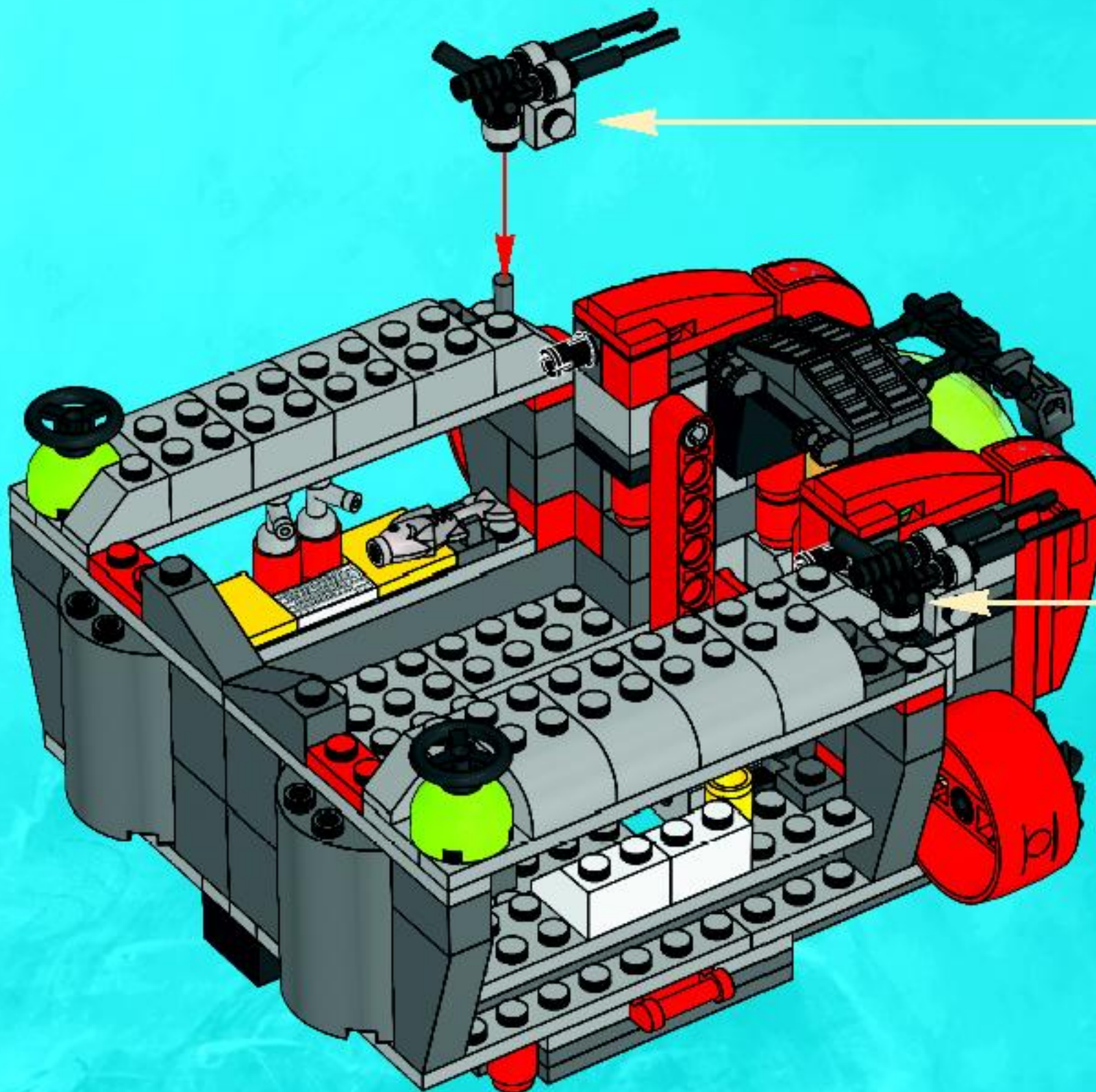
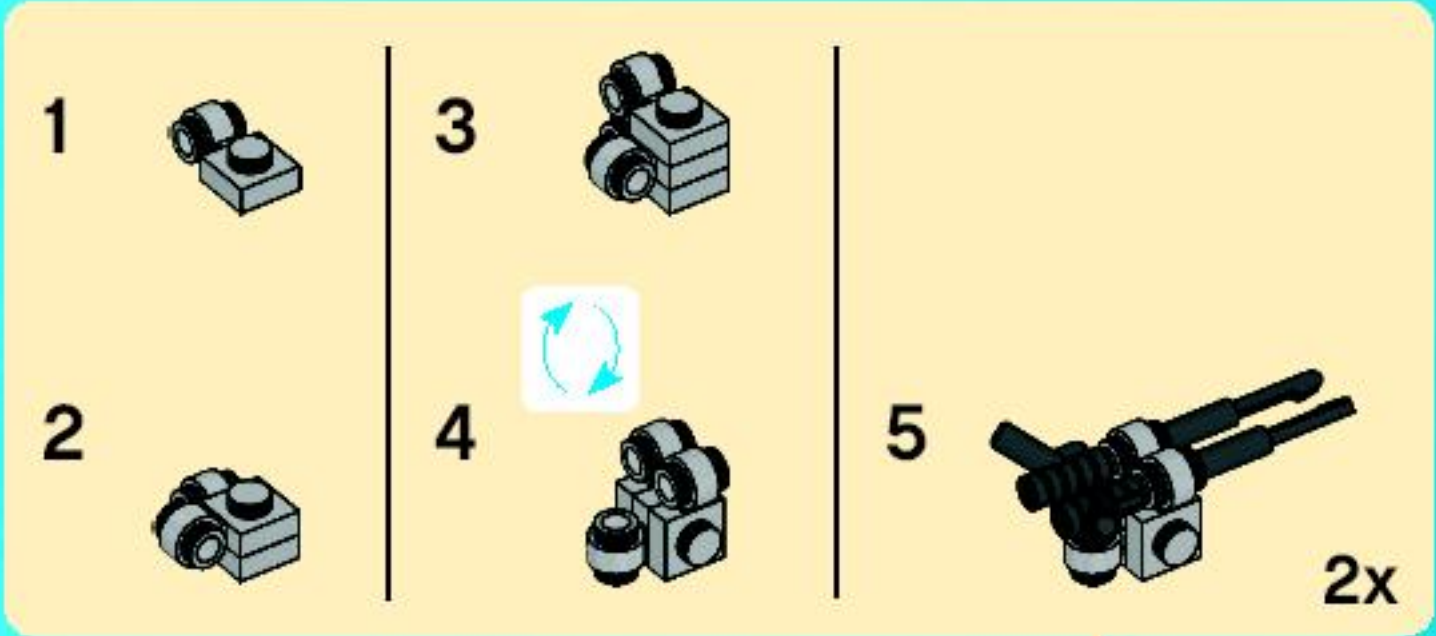

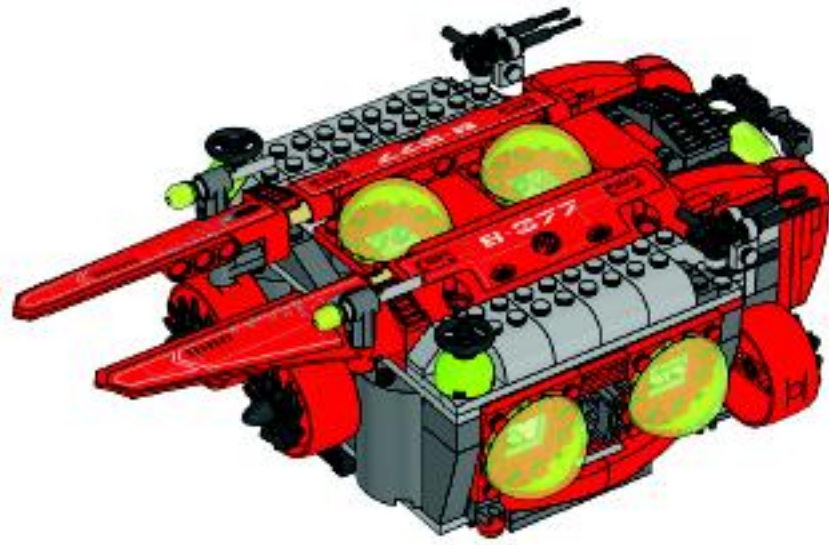

2x



1x



1x

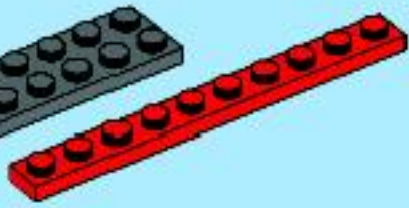

1x

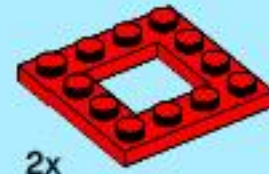

2x

1

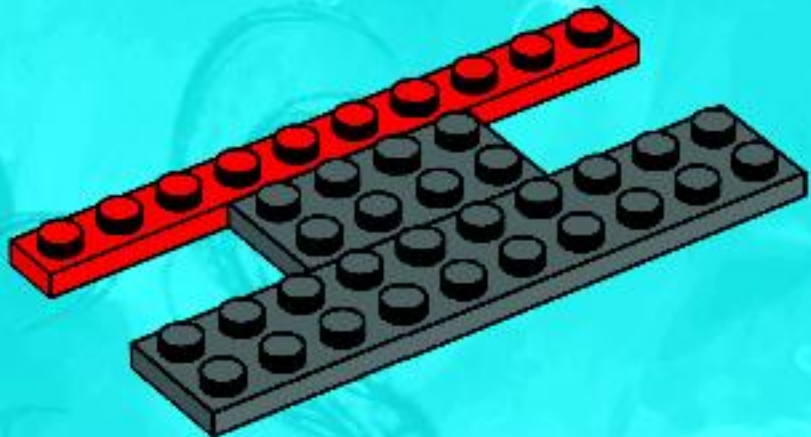

2

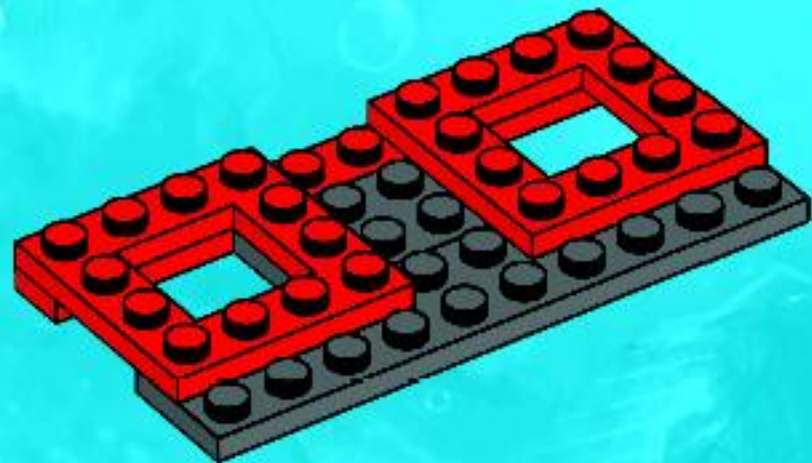



2x



1x

3

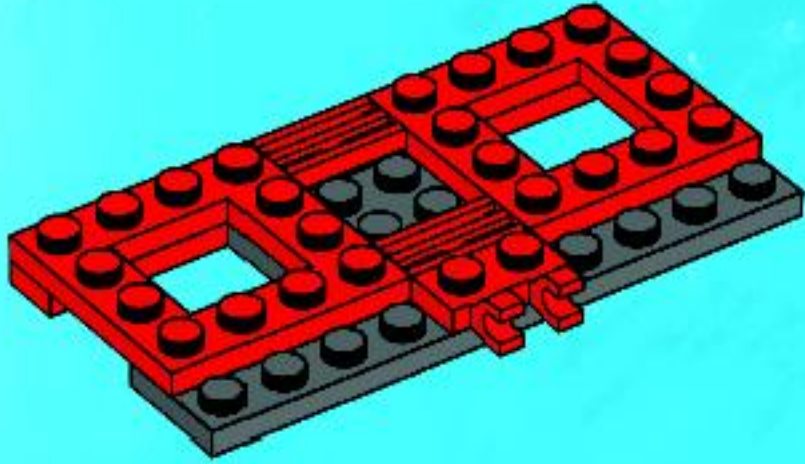

2x



2x



1x

4

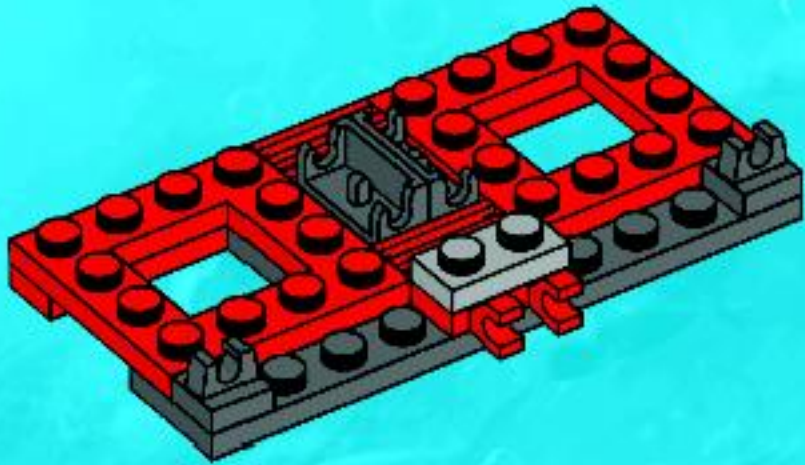

2x

5

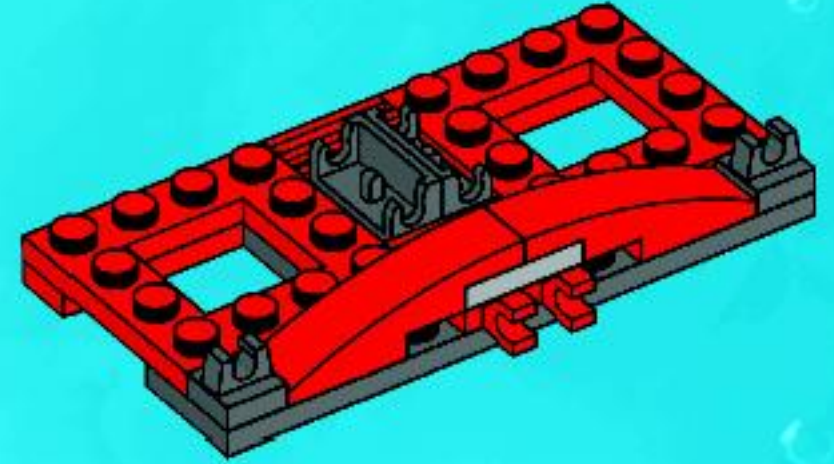

2x

6

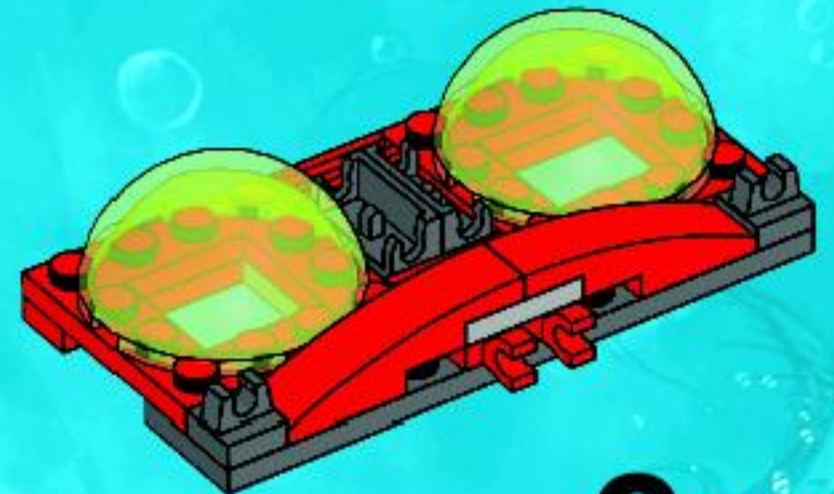

2x

43

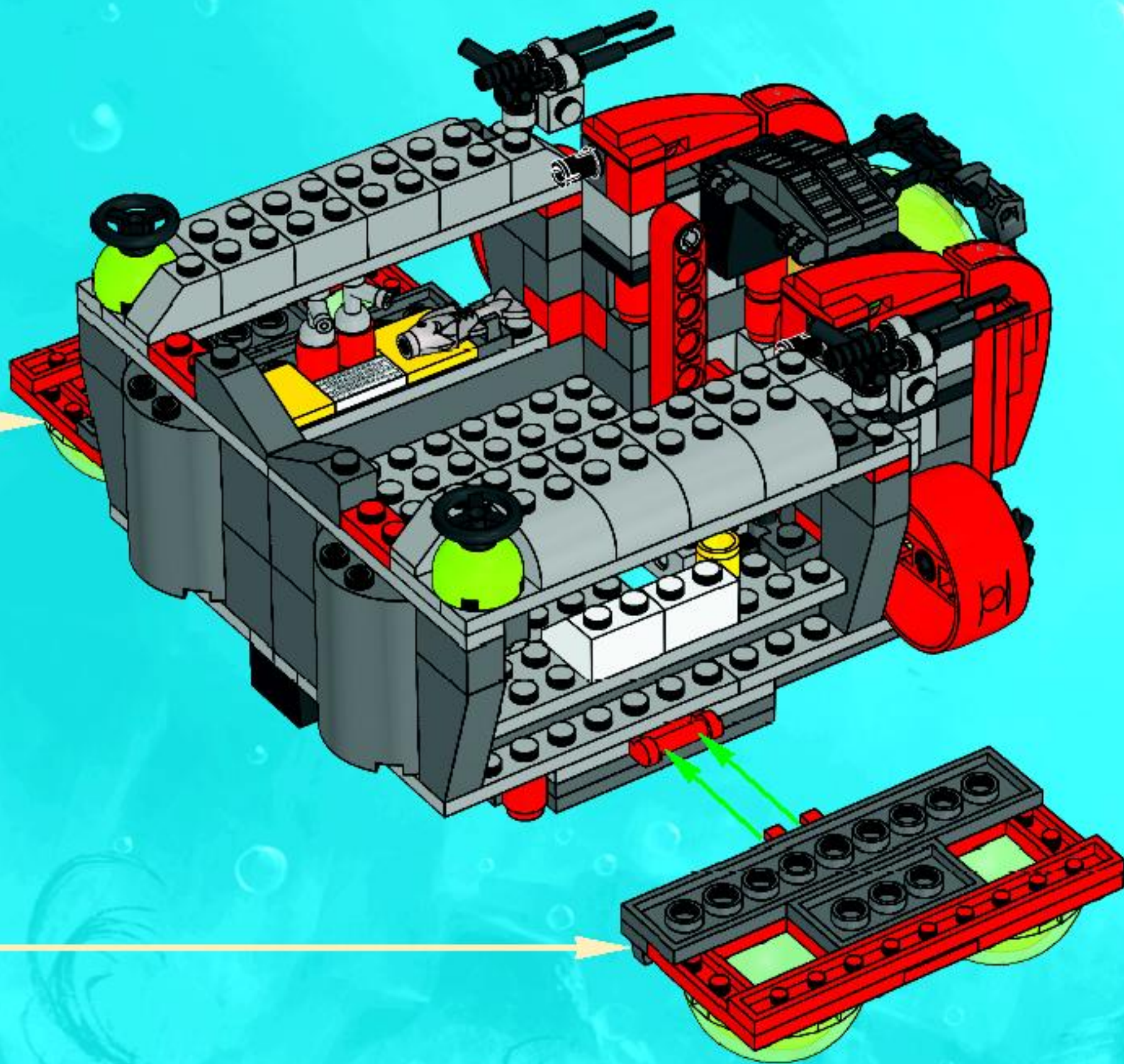

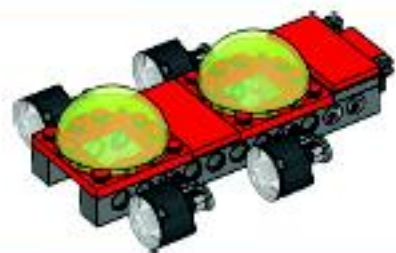

2x



3x

1

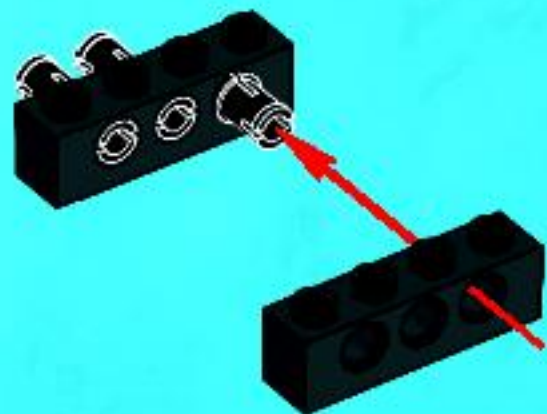

2x

2

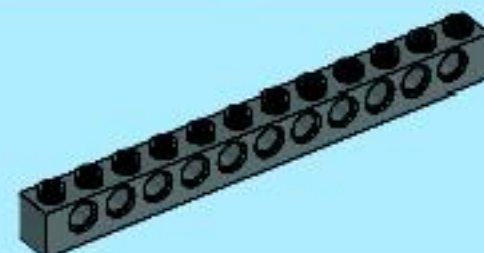
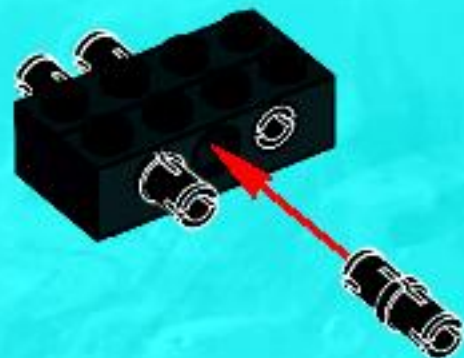

2x

3

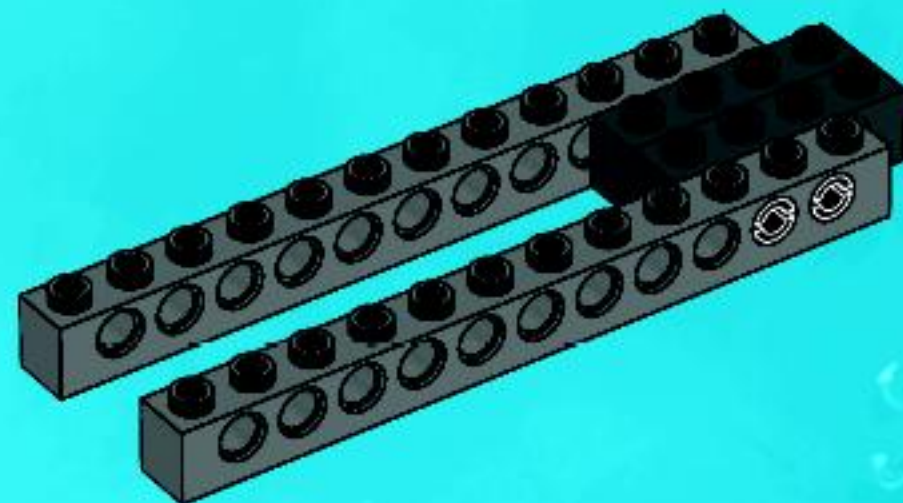

1x



2x



1x

4

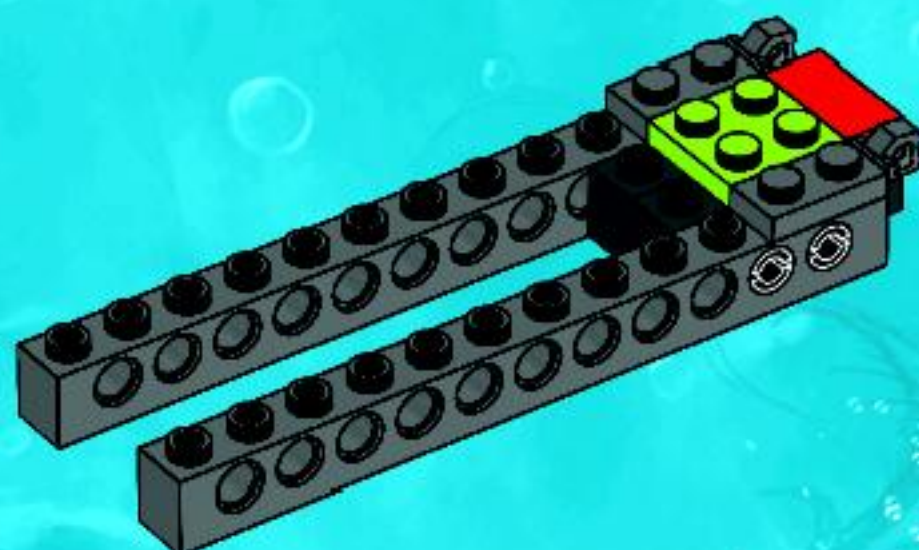



5

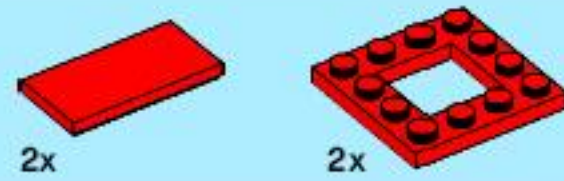
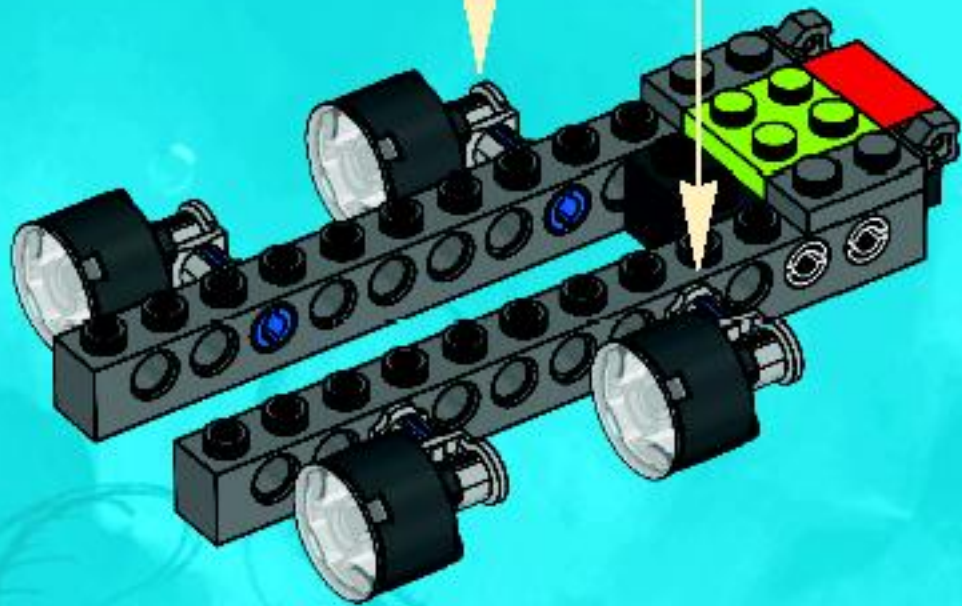
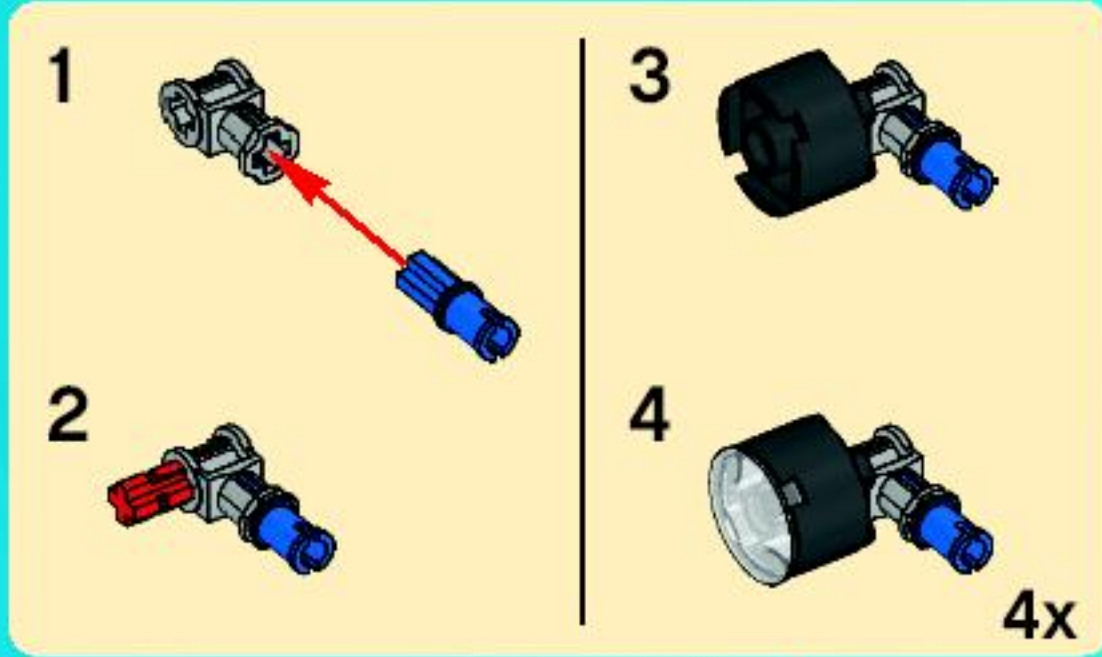

6

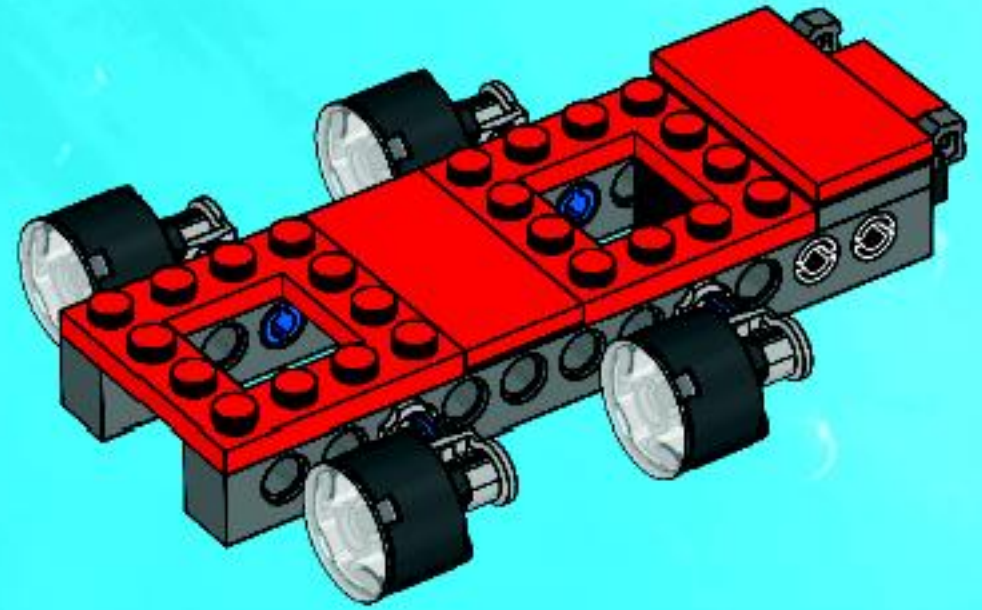

7

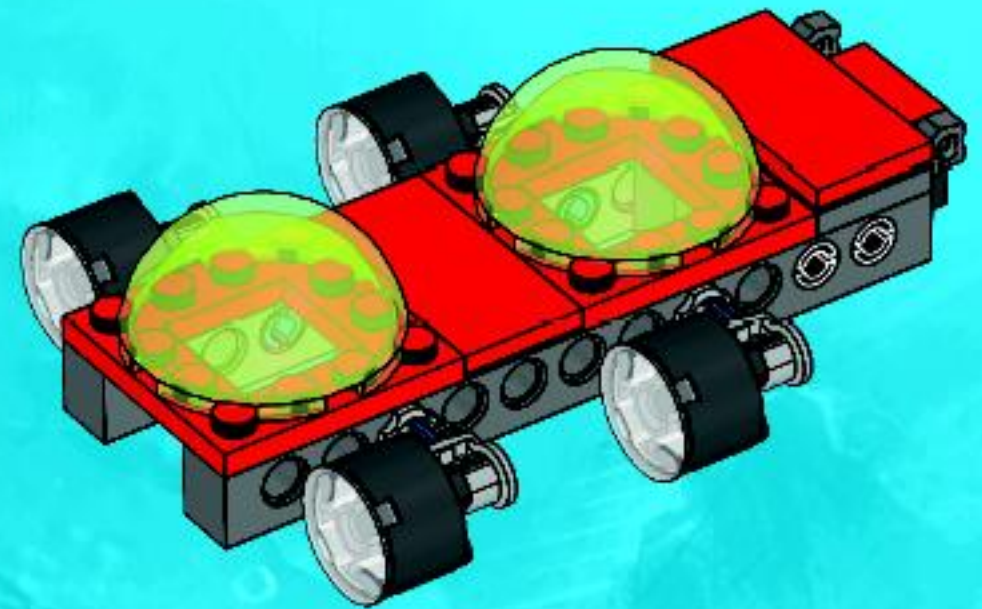

44

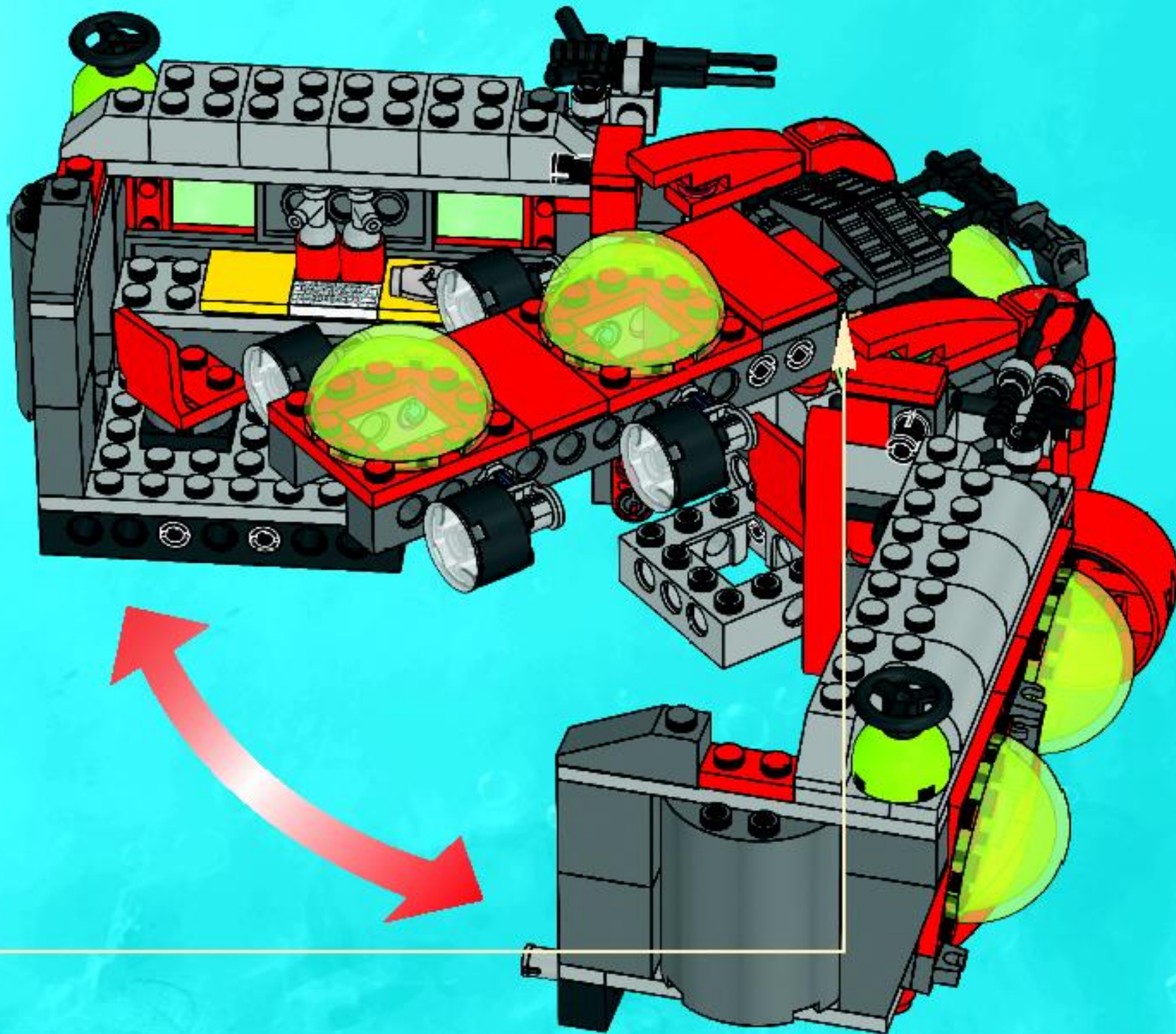

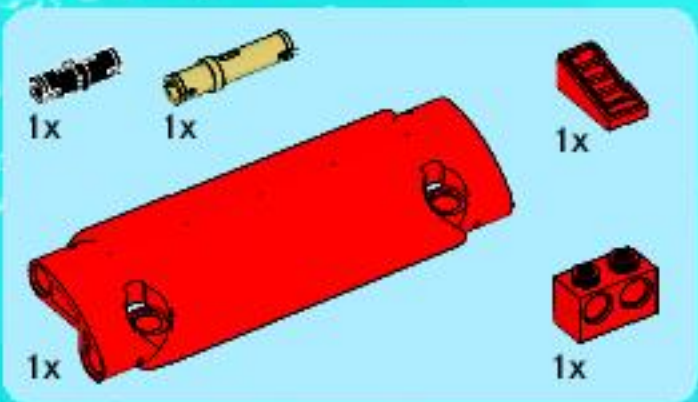

45

1

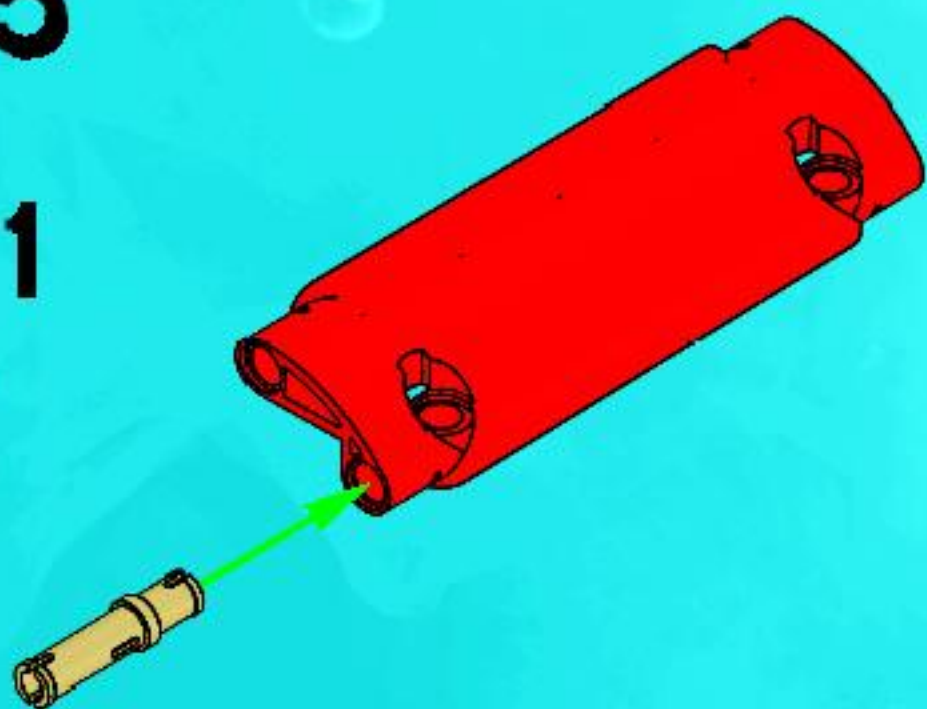

2

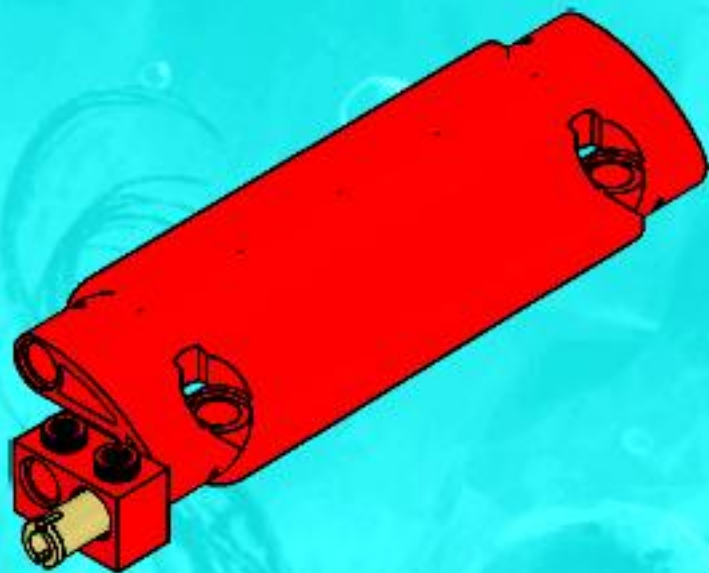

3

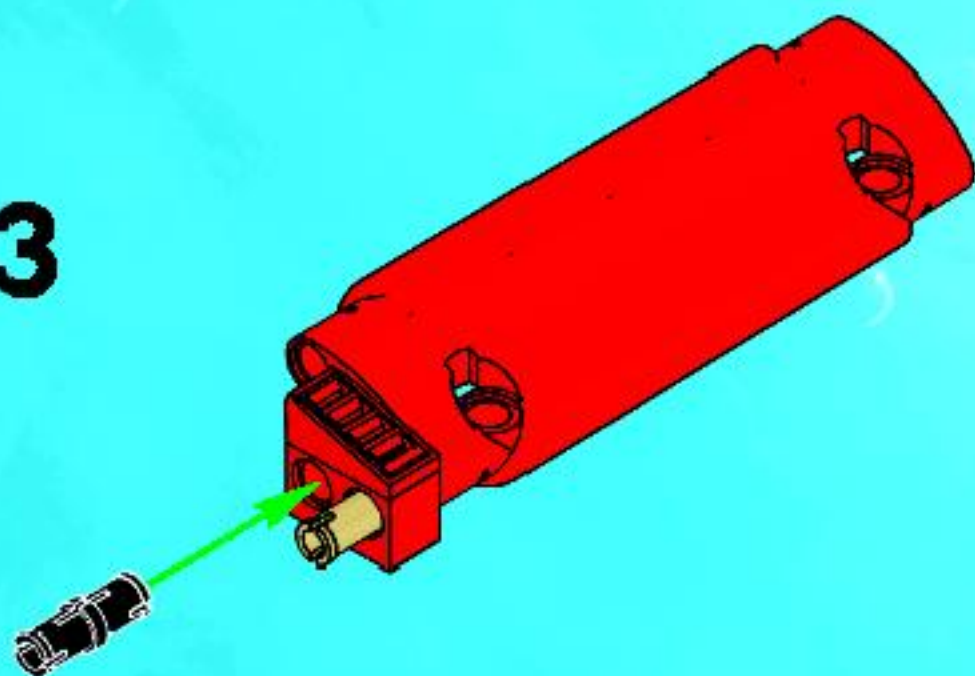

4

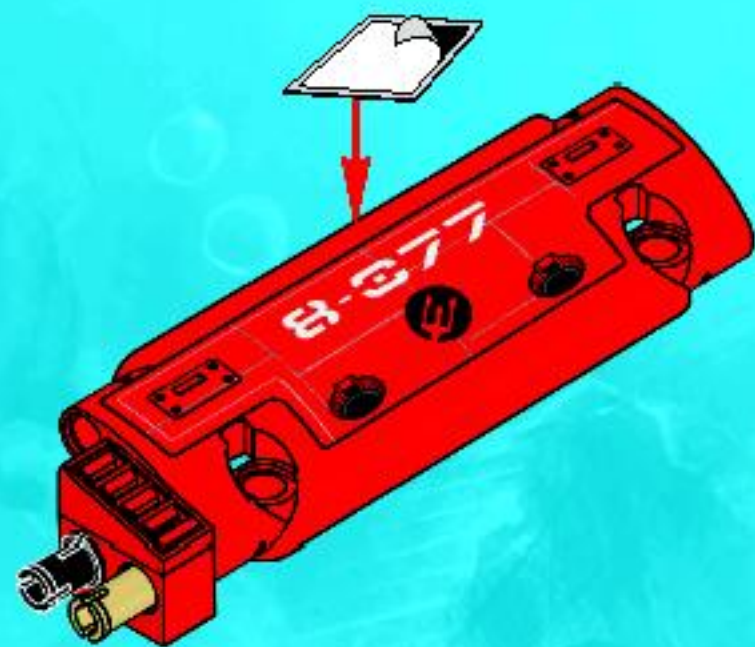

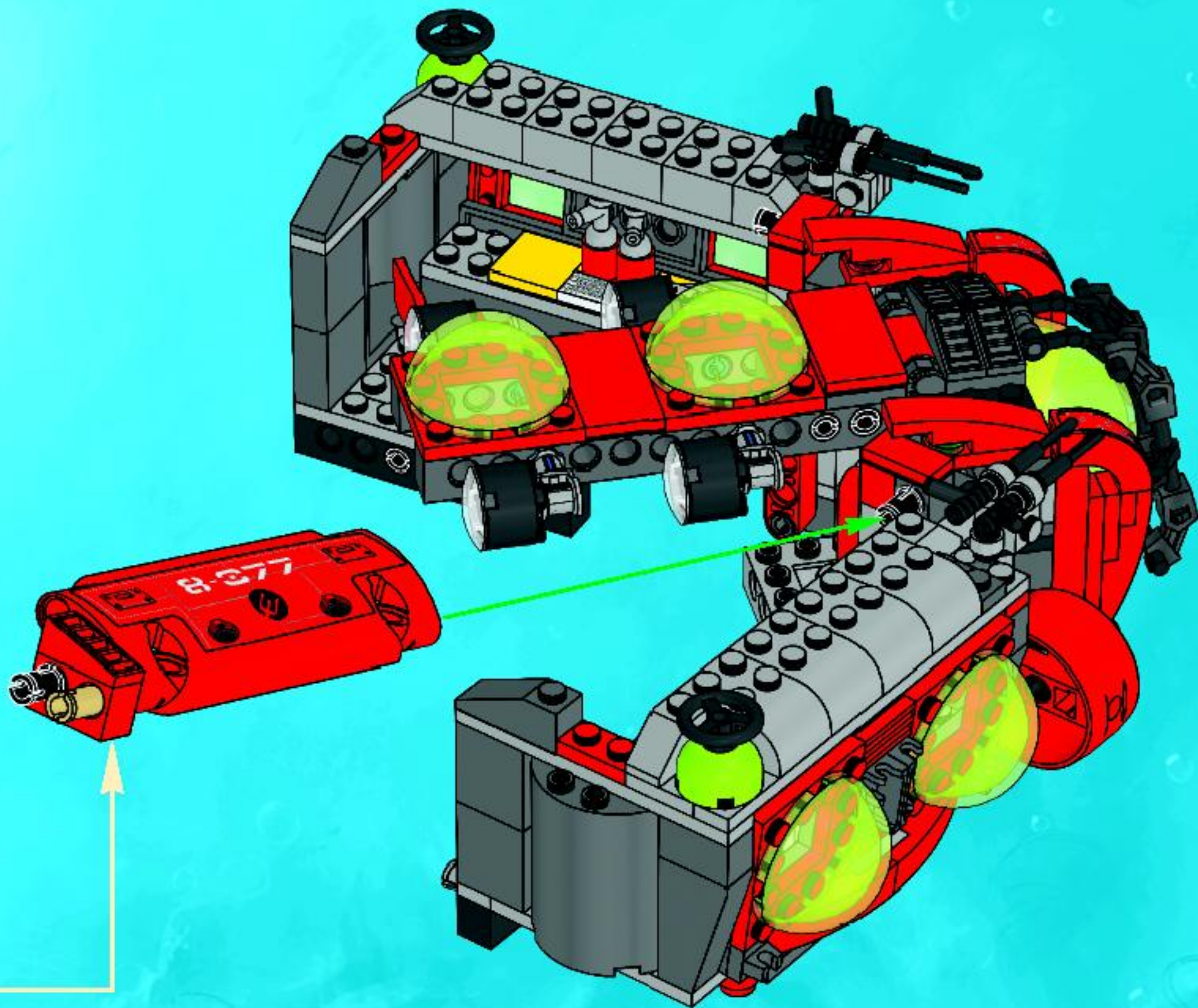

46

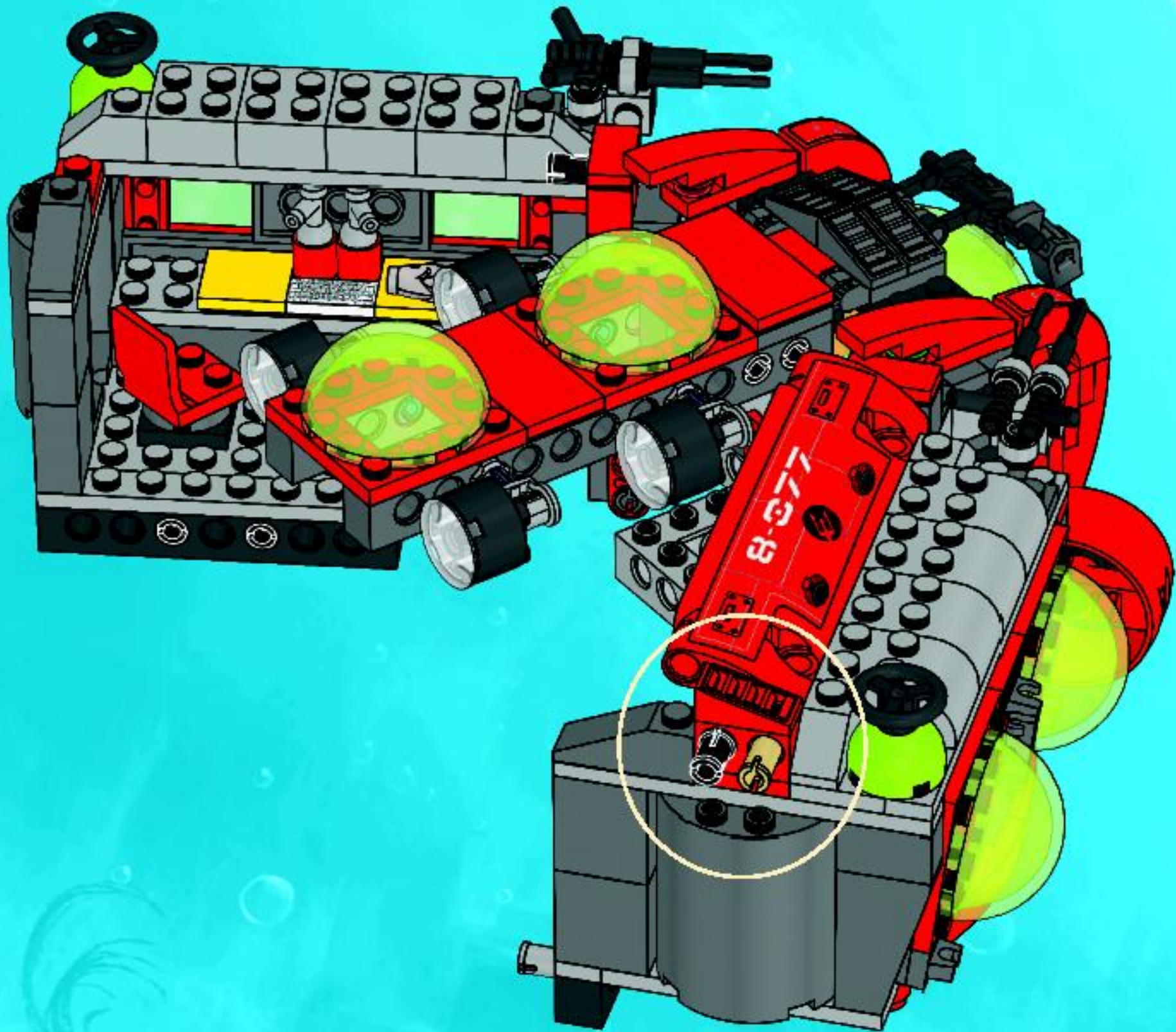

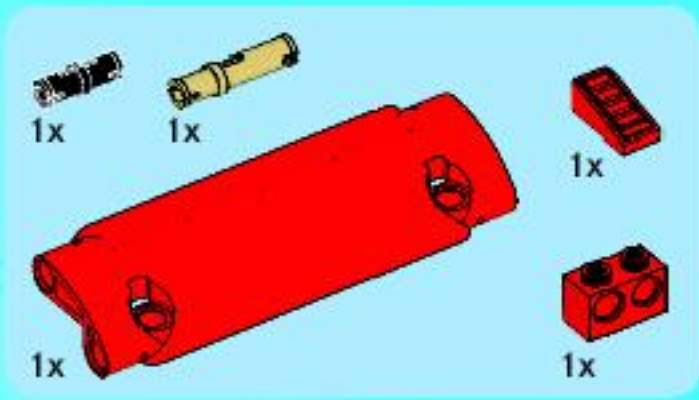

47

1

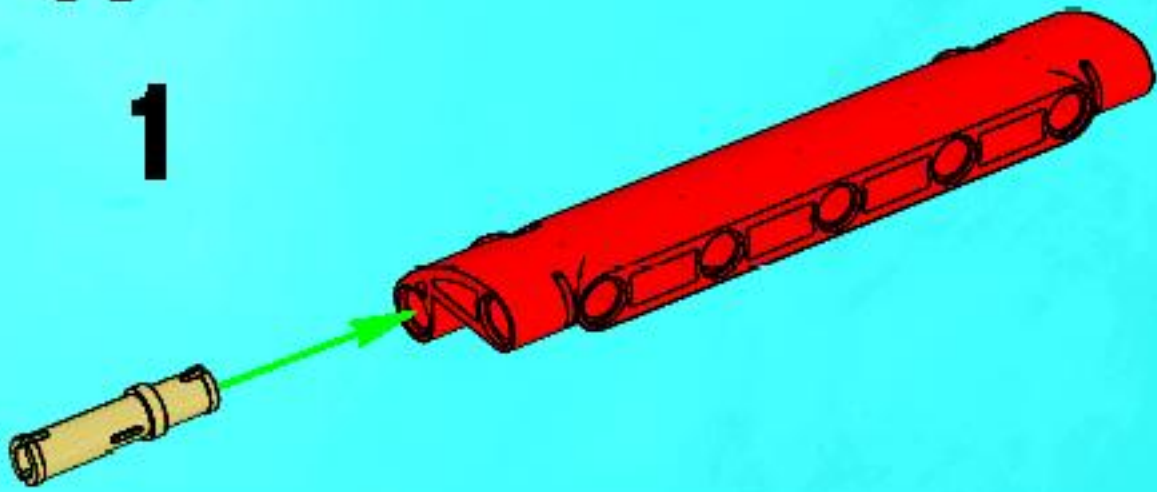

2

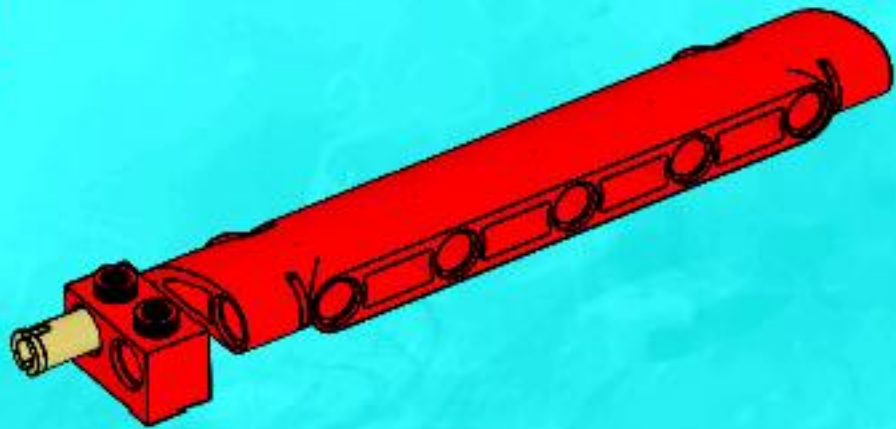

3

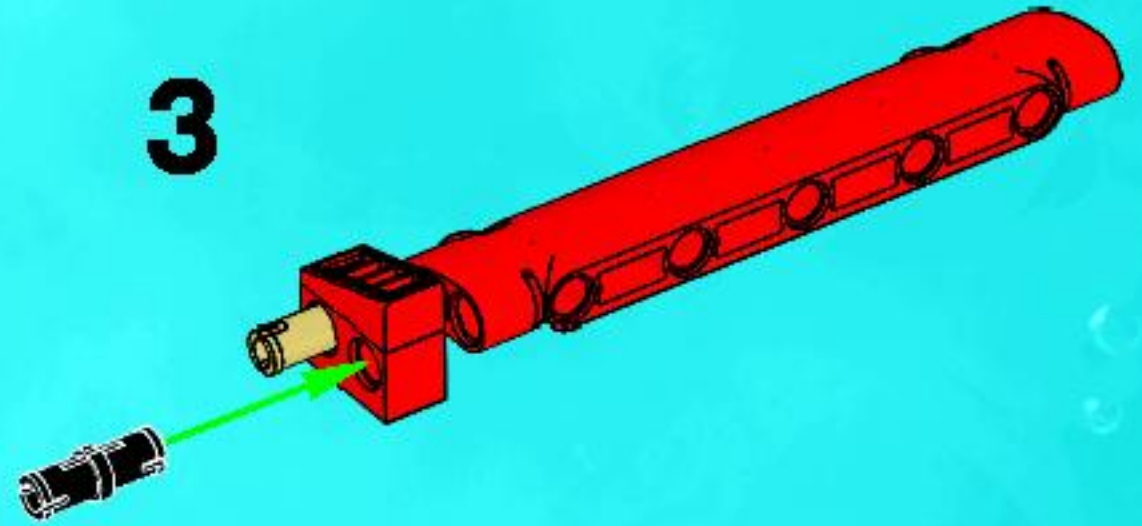

4

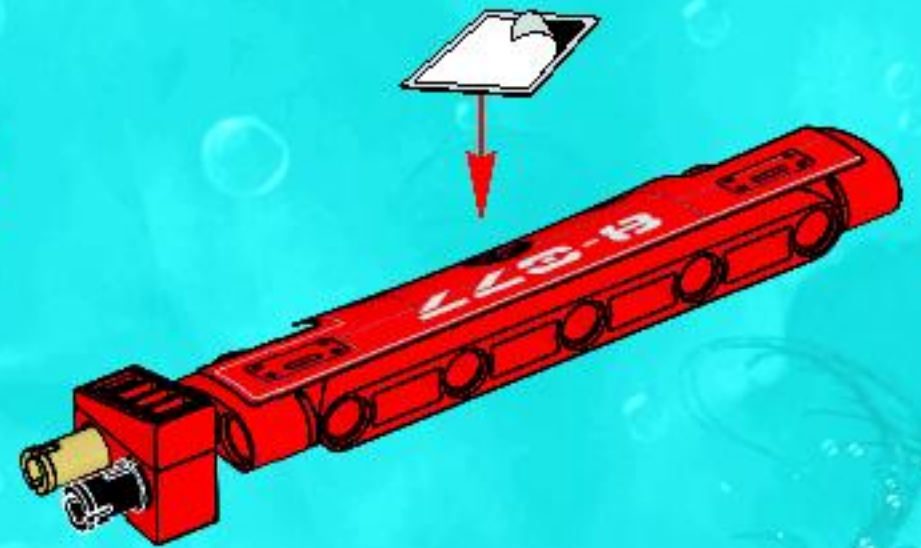

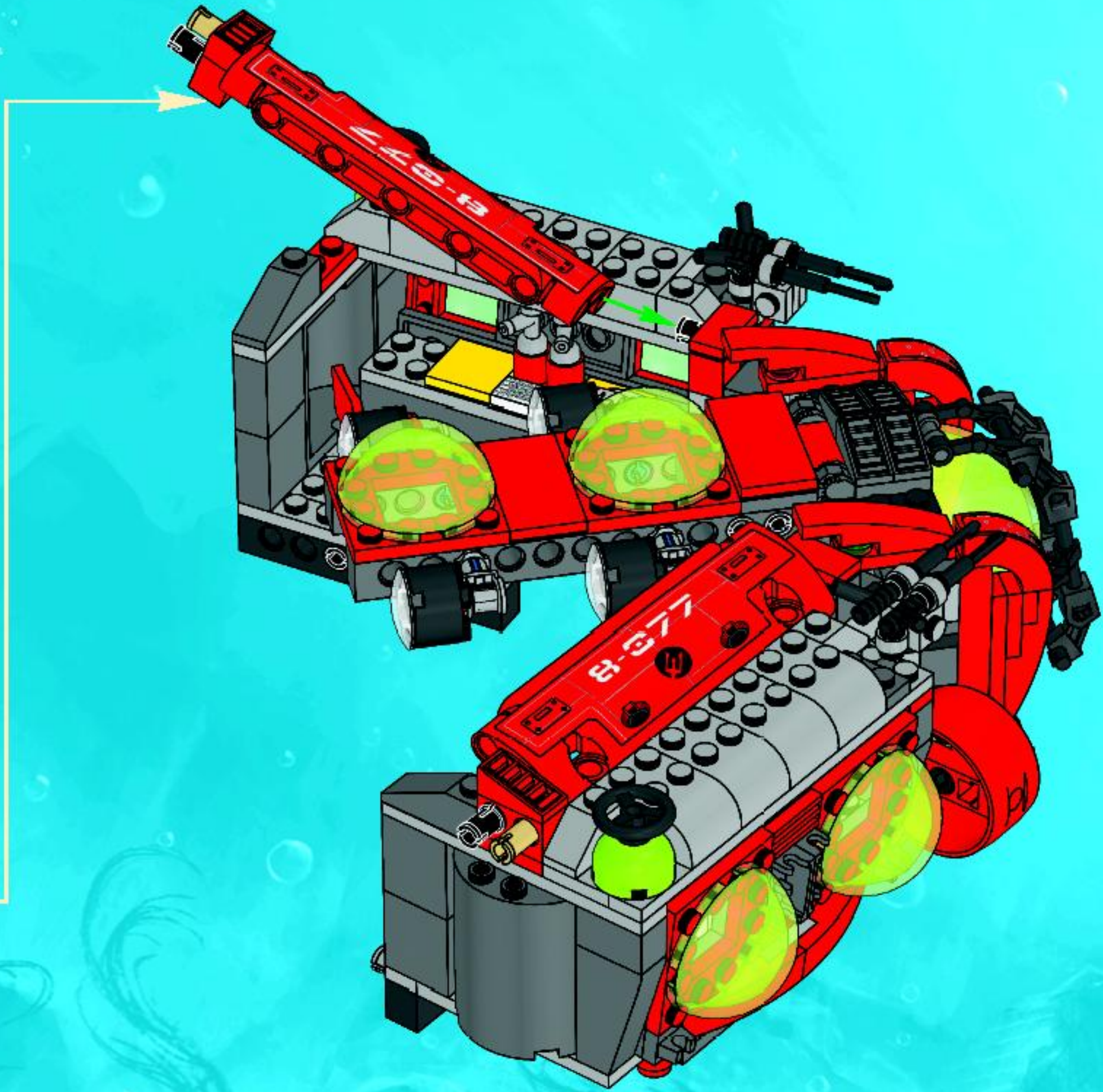

48

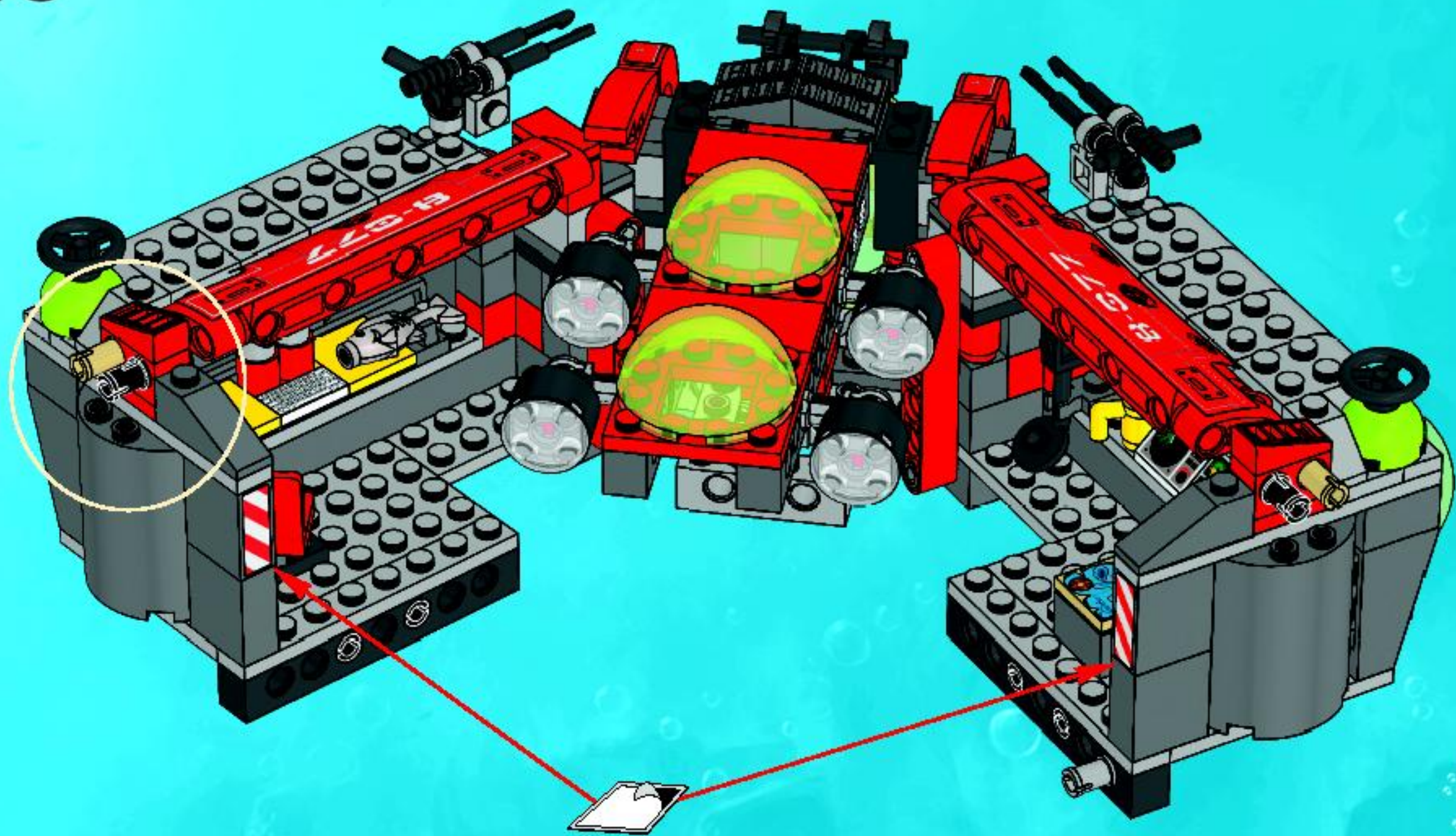

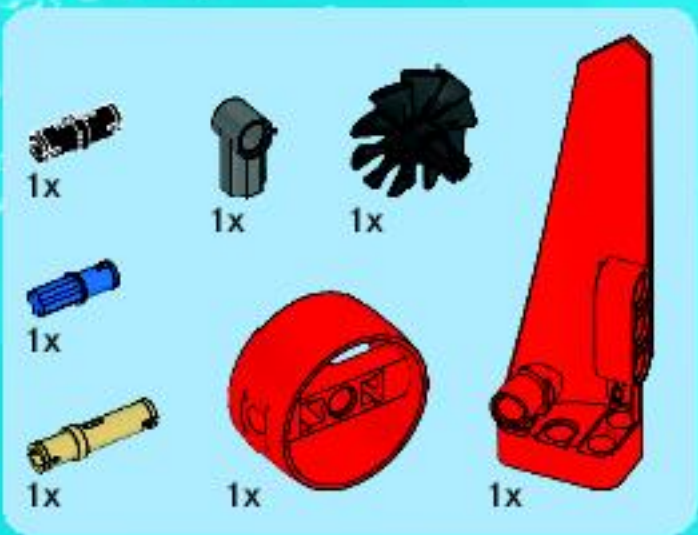

49

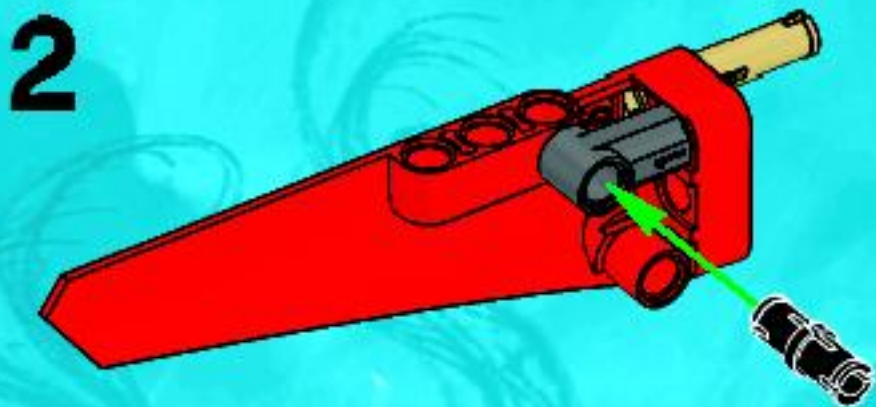
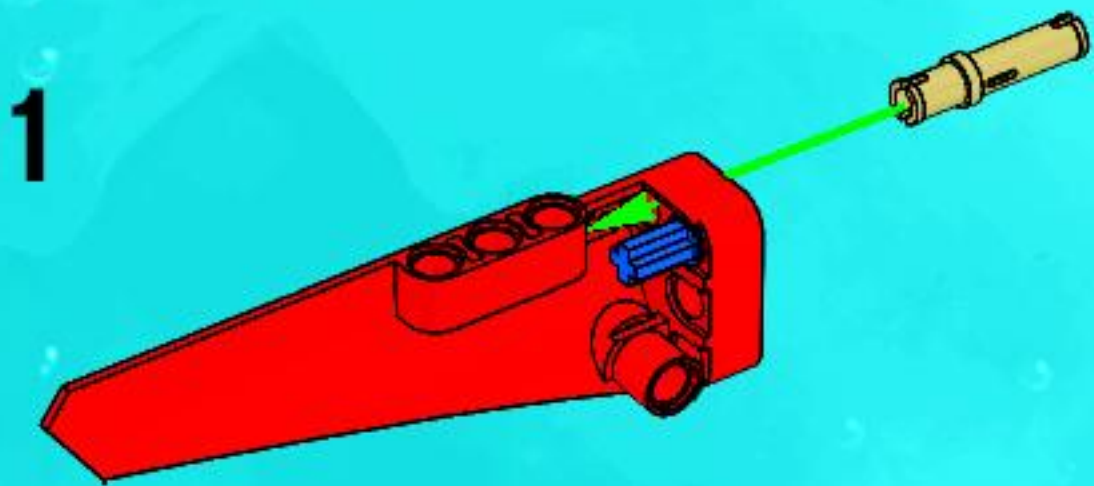

3

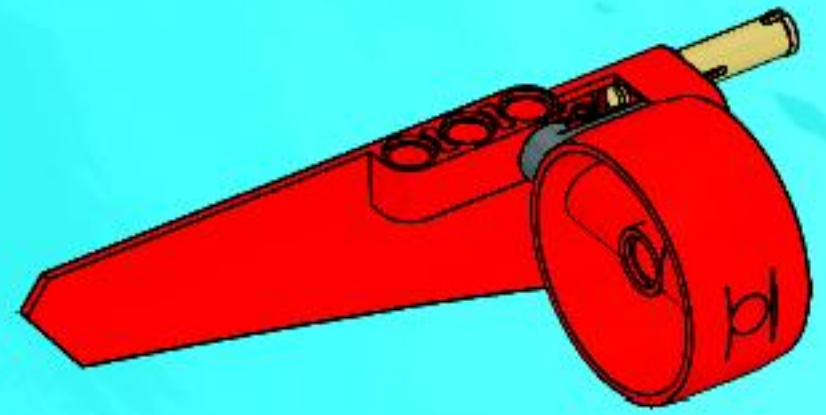

4

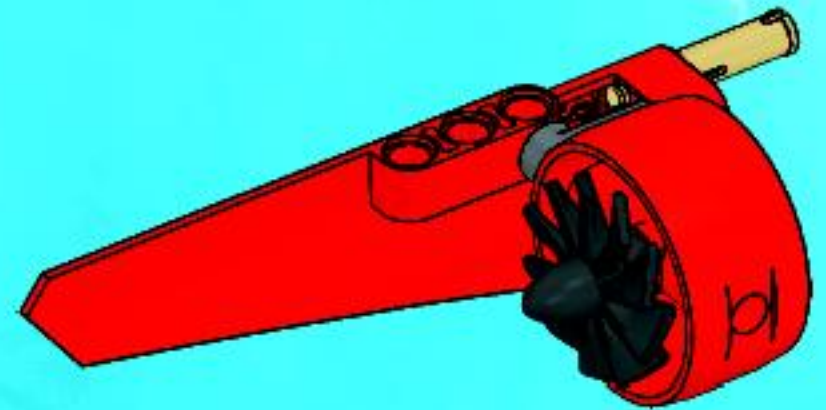

5



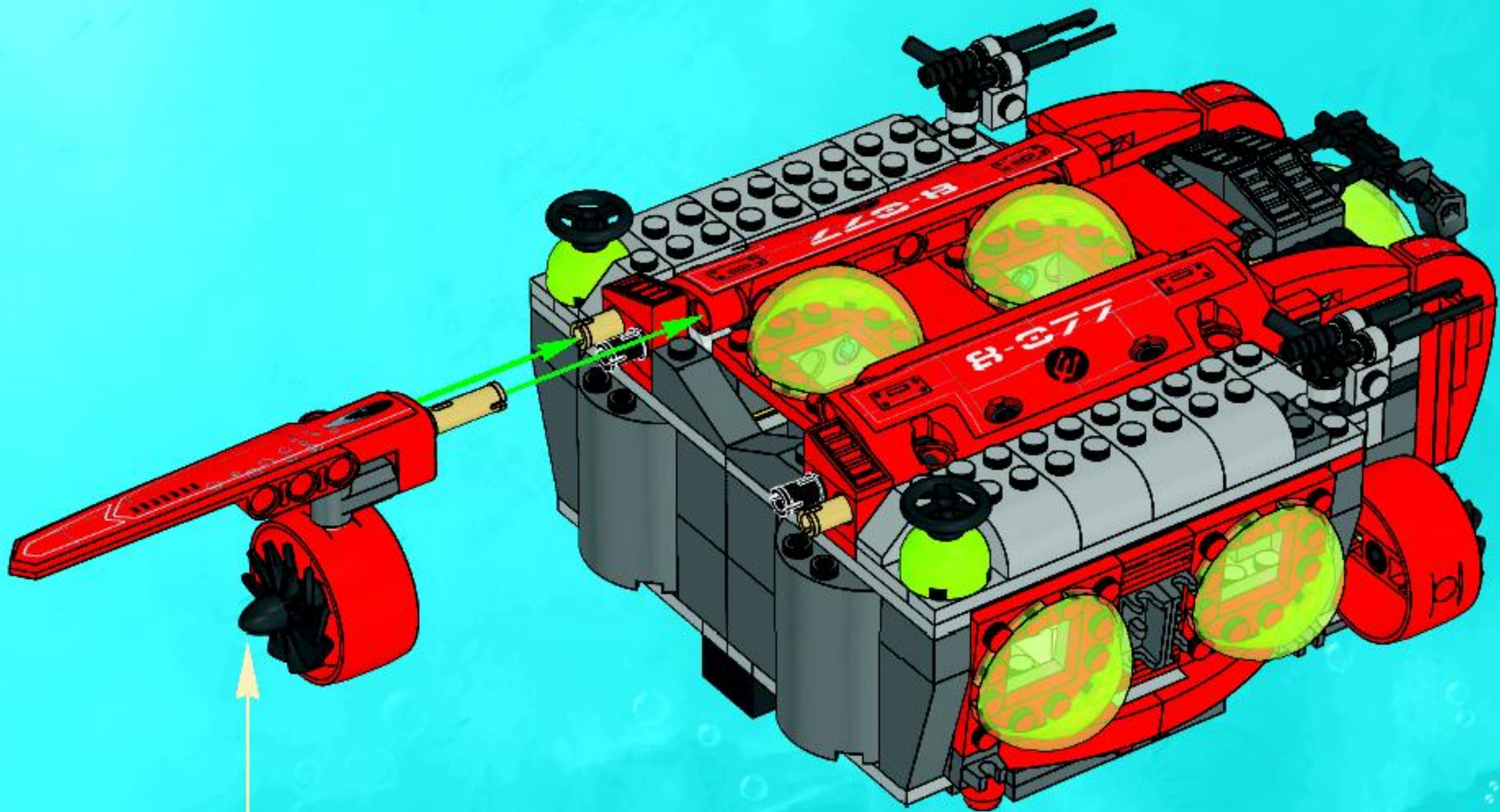

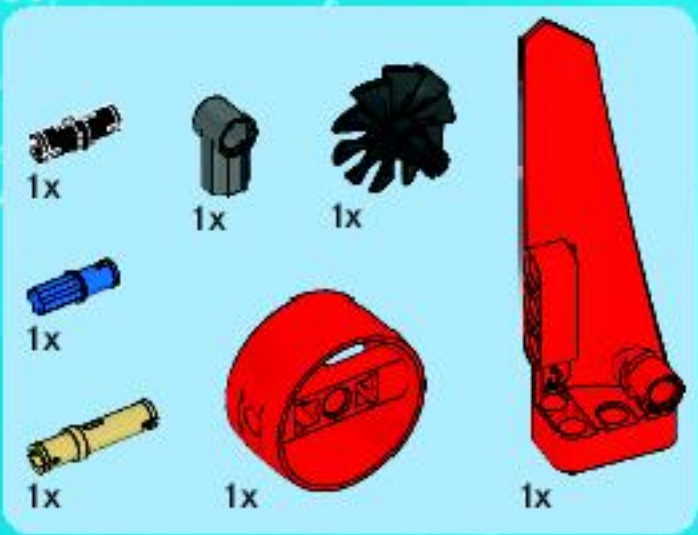

50

1

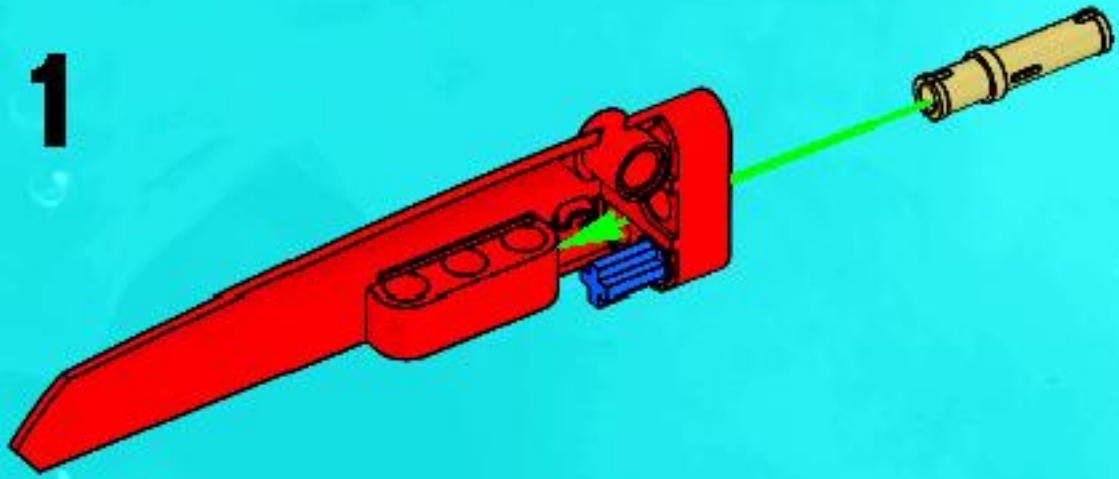

2

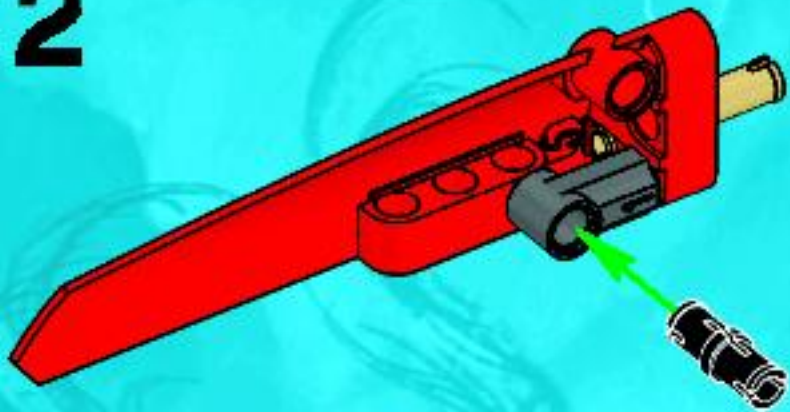

3

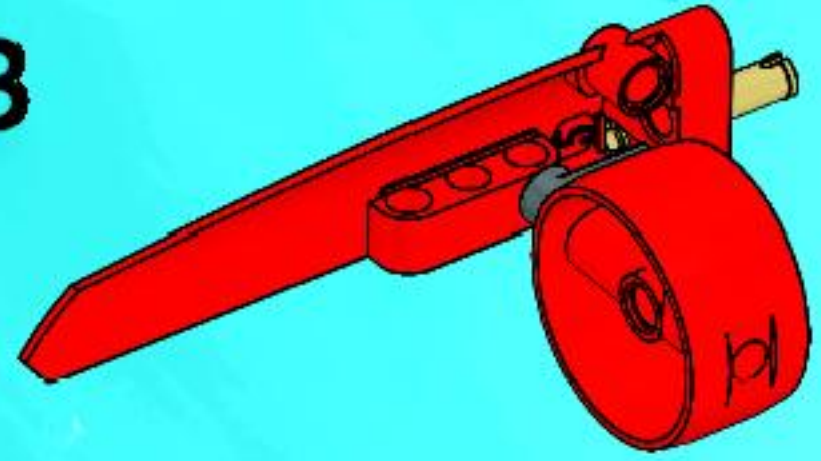

4

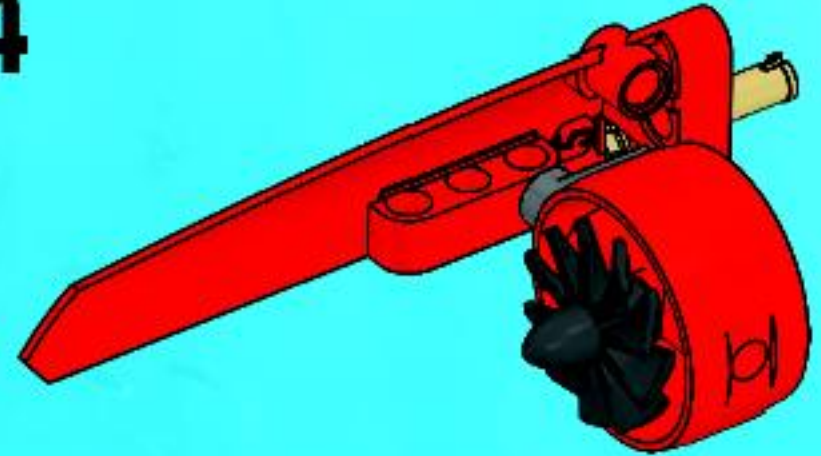

5

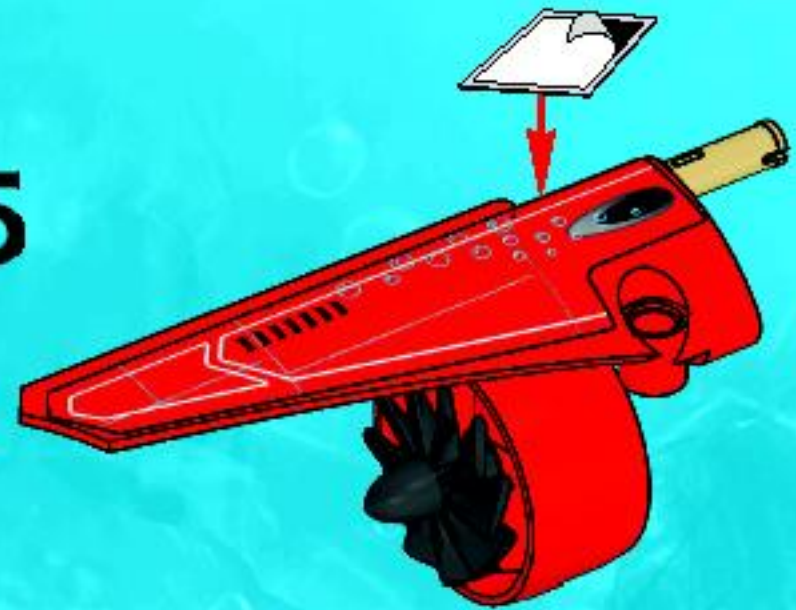

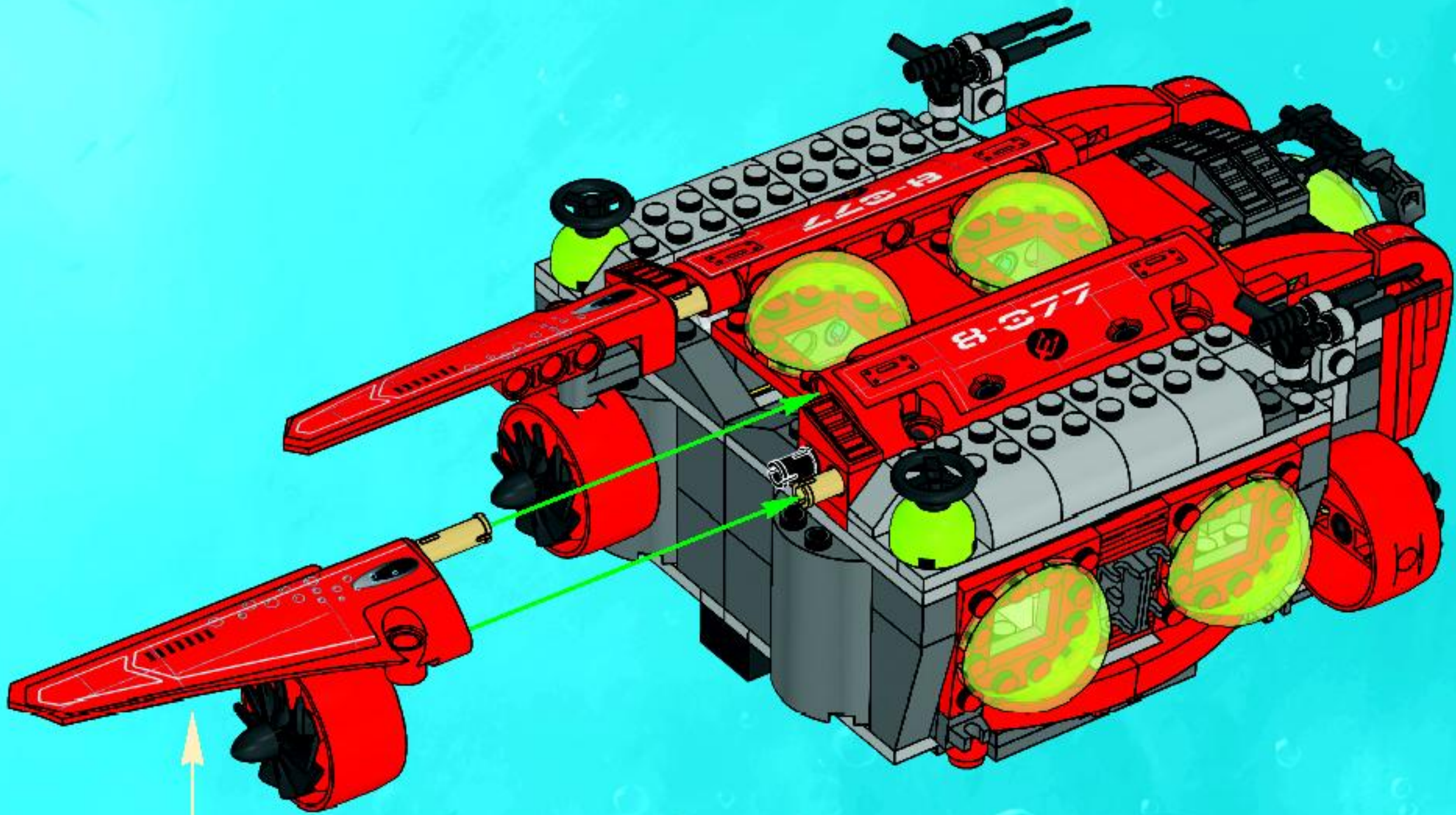



2x



2x



2x

51

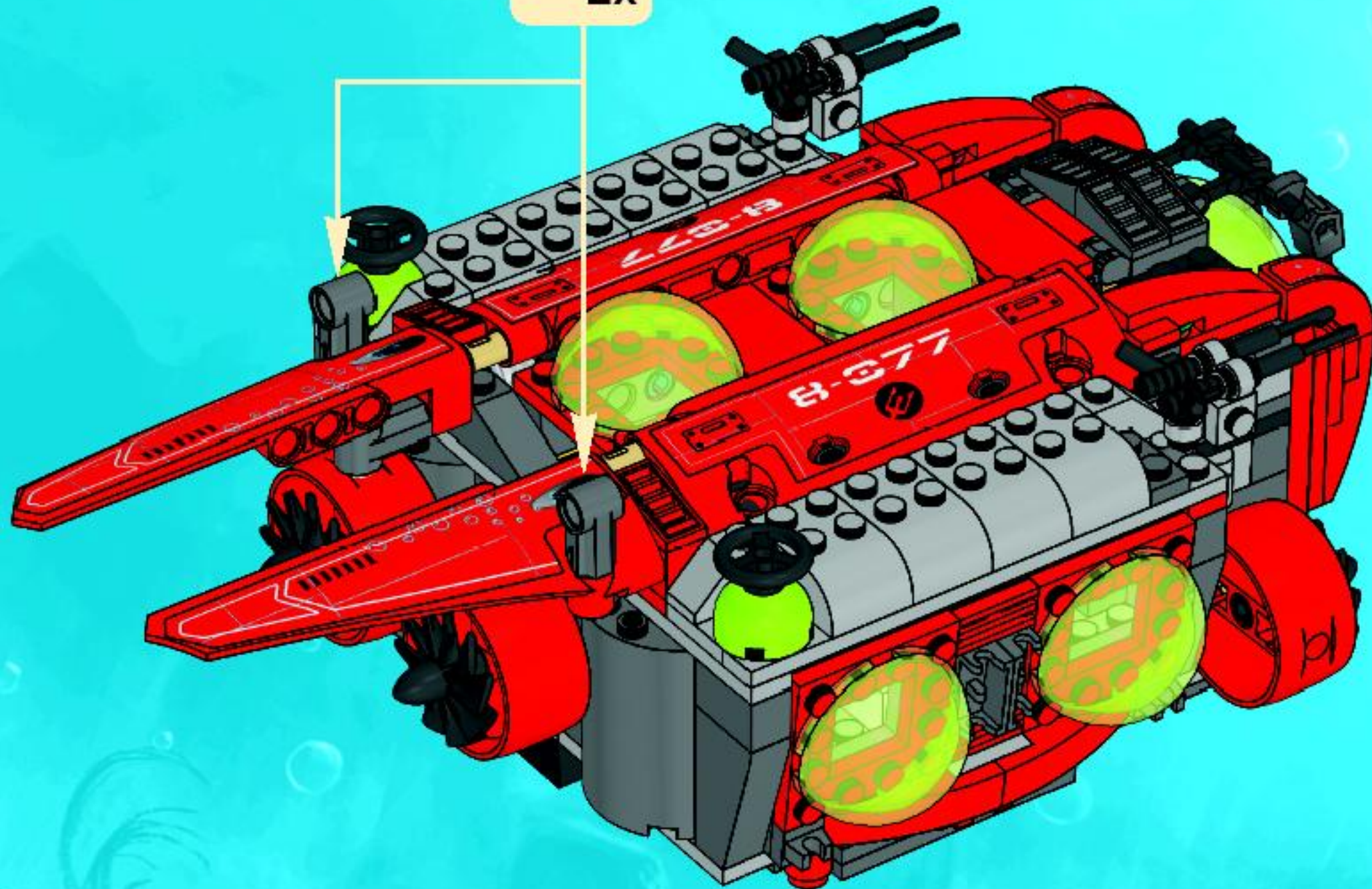



2x



2x

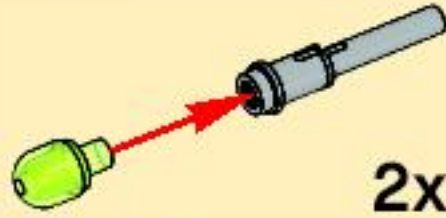

2x



52

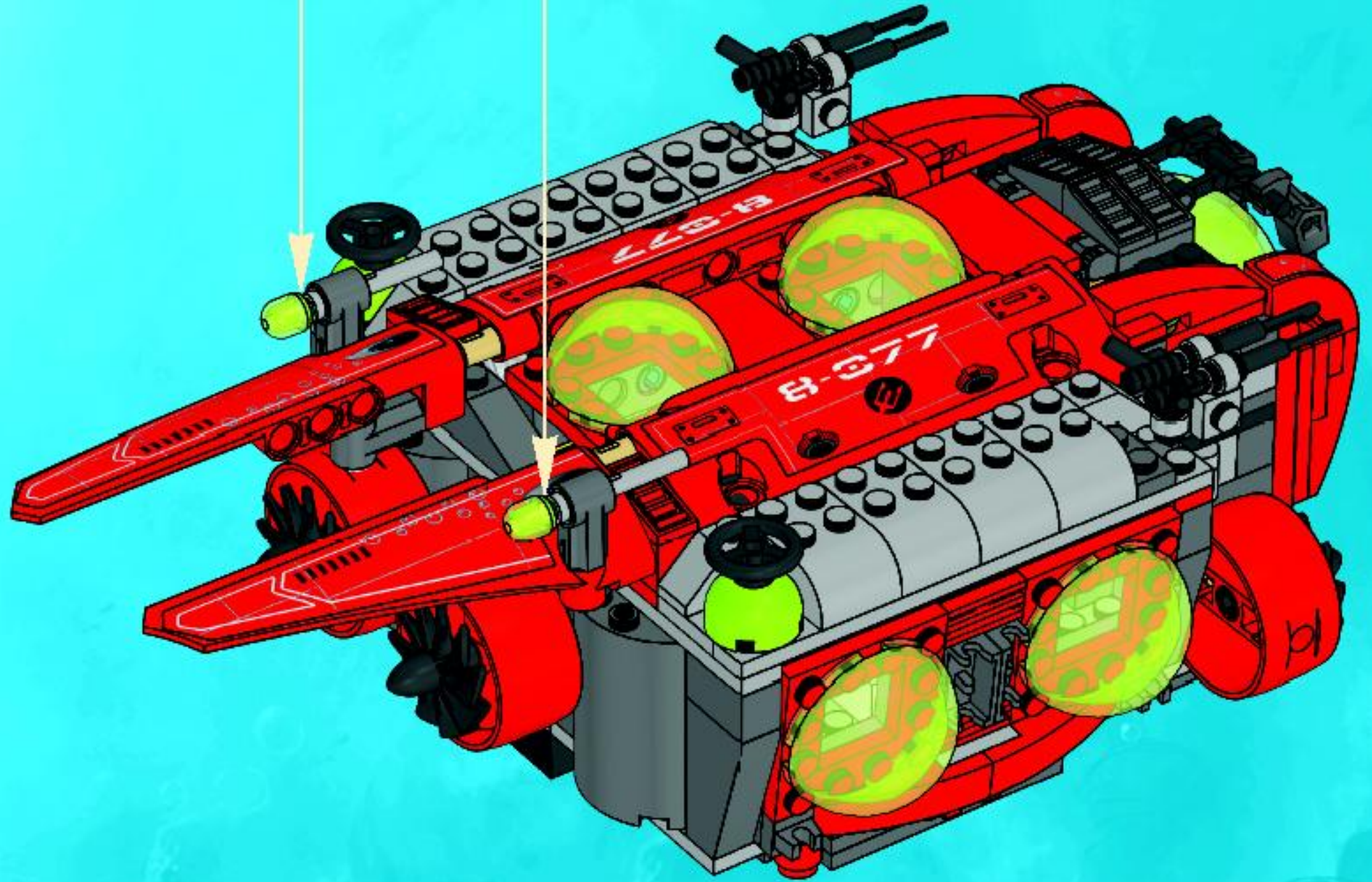

1

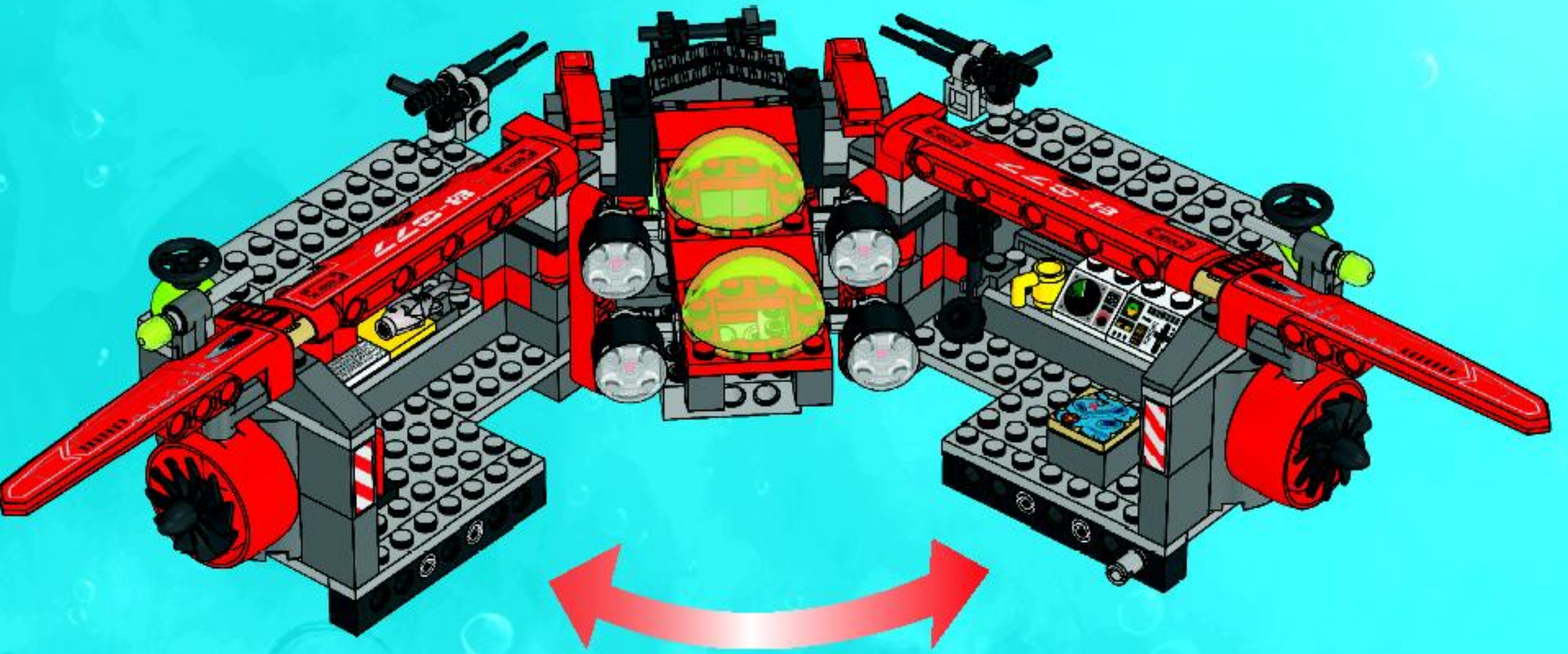

2

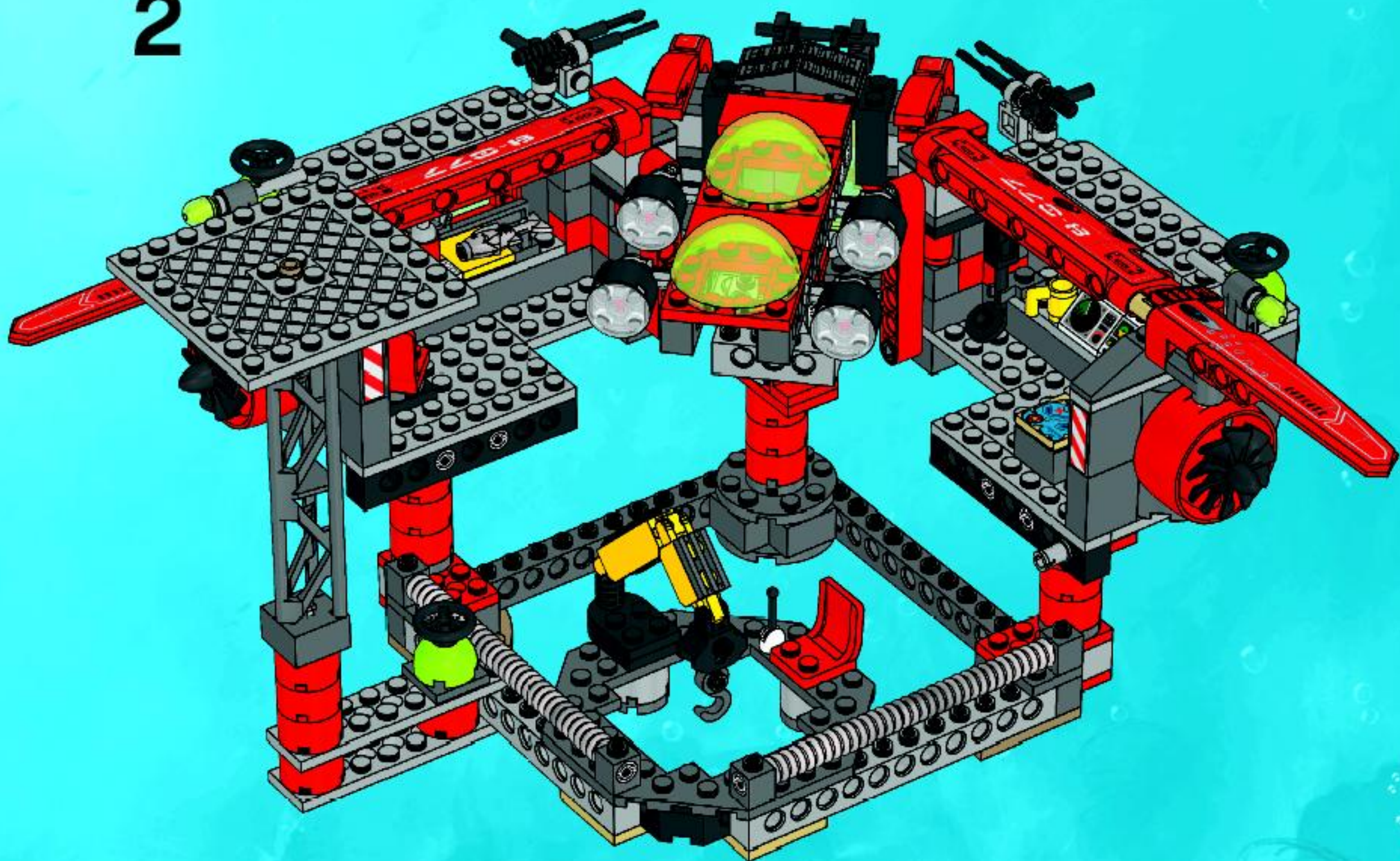







8058



8058



8075



8075



8077



72 8077



8078



8078



8076



8076



ATLANTIS

MAP OF ATLANTIS

LO 230:23.5
LA 40:22.7
ETA 02.43.00

SIM 440:00.5
IN 10:11.1
OUT 30.33.33

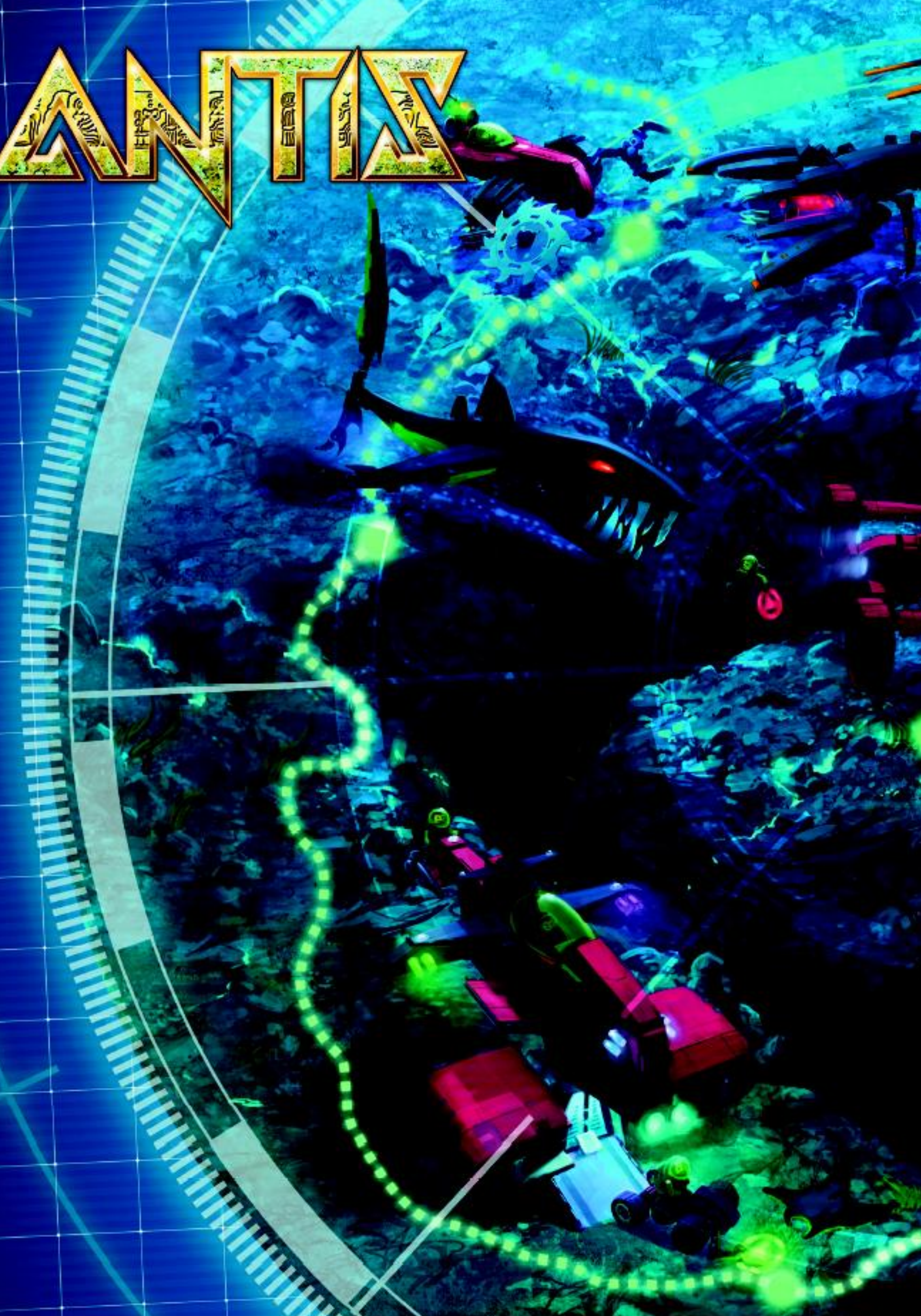

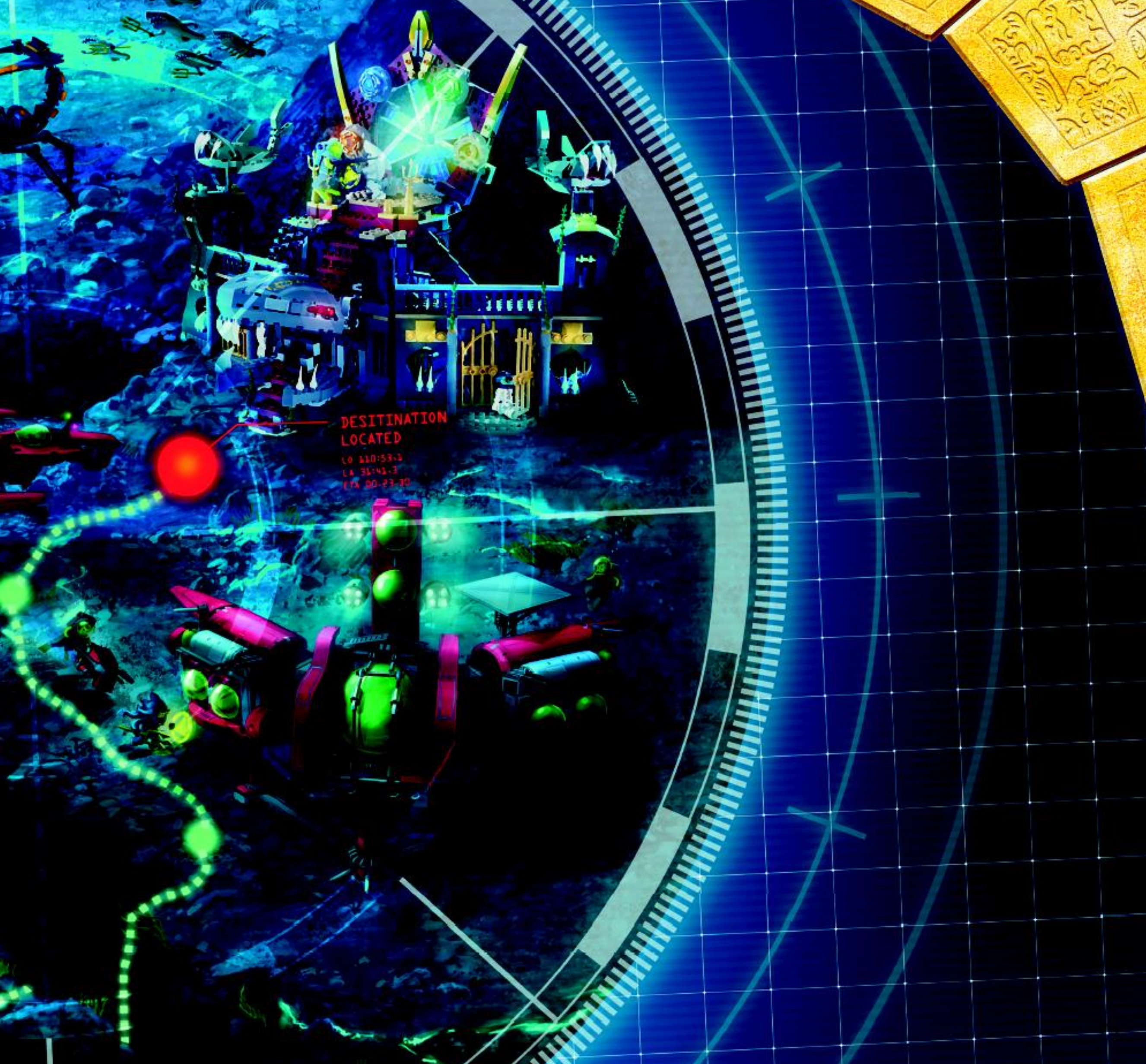

DESTINATION
LOCATED

LO 110:59.1
LA 36:43.3
ETA 00:23:30



WIN!

Go to www.nielsen.com/LEGO
to fill out a survey for a chance
to win a cool LEGO® Product.
No purchase necessary.
Open to all residents where not prohibited.



www.nielsen.com/LEGO

GEWINNE! WIN!

Nimm an der Umfrage auf
[www.nielsen.com/](http://www.nielsen.com/LEGO)
LEGO teil und hab die Chance ein cooles
LEGO® Produkt zu gewinnen!

Die Teilnahme am Gewinnspiel führt zu keinerlei
Kaufverpflichtungen. Teilnahme in allen nicht
ausgeschlossenen Ländern möglich.

Ga naar www.nielsen.com/LEGO,
vul een enquêteformulier in en
maak kans op een
cool LEGO® product.

Geen aankoopverplichting.
Iedereen mag deelnemen, uitzonderd
ingezetenden
van landen waar een enquêteverbod geldt.

GAGNE! 当てよう!

Visite www.nielsen.com/LEGO
pour répondre à un questionnaire
et avoir une chance de gagner
un produit LEGO® très cool!

Aucune obligation d'achat.
Ouvert à tous les résidents des pays
autorisés.

www.nielsen.com/LEGOにアクセスして、アンケ
ートにご記入ください。当選者にはレゴ製品を
差し上げます。

お買い上げの必要はありません。

禁止されていない限り、すべての管轄にご利用いただけます。