

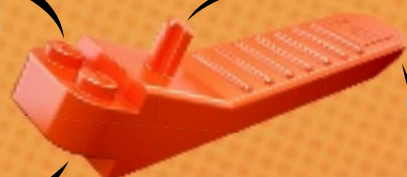

DC UNIVERSE
**SUPER
HEROES**

10937





LEGO.com/brickseparator

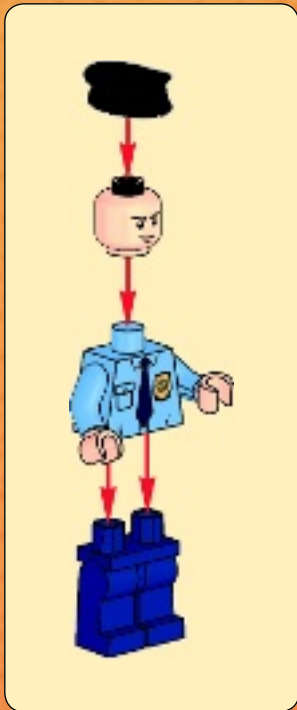

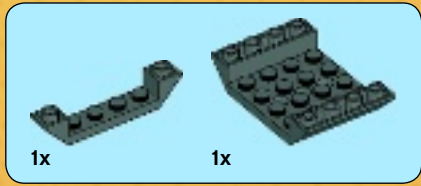

1

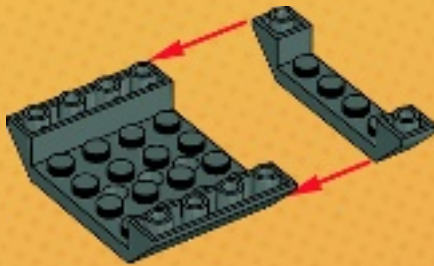

2



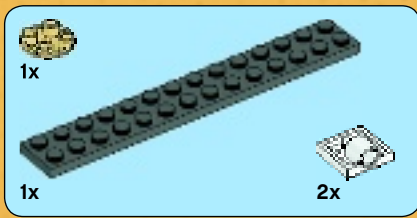

3

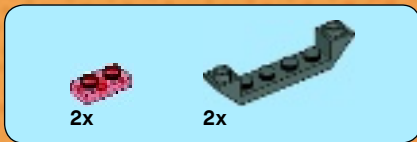
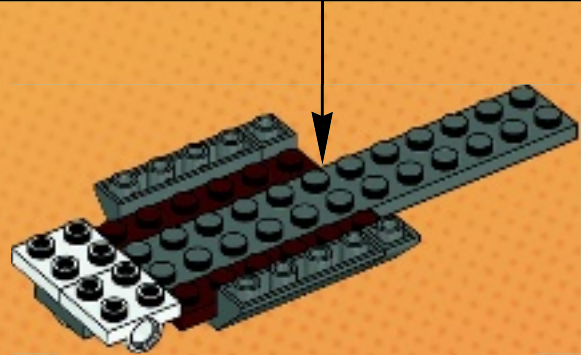
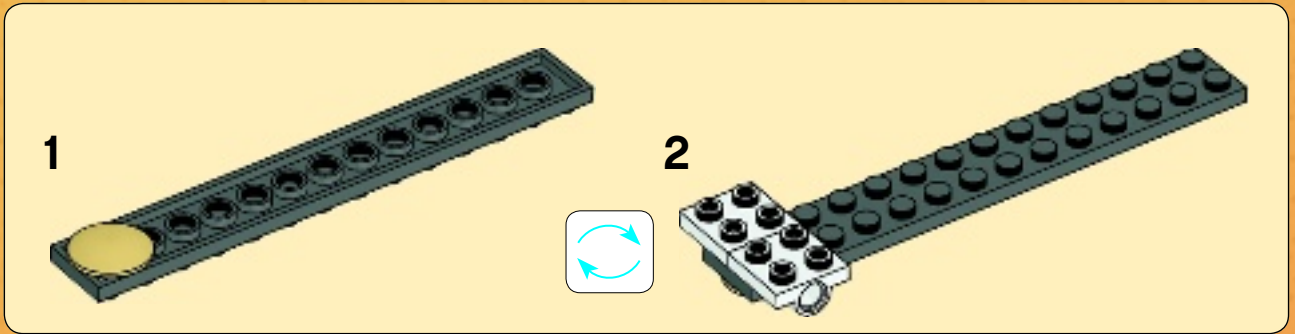

4

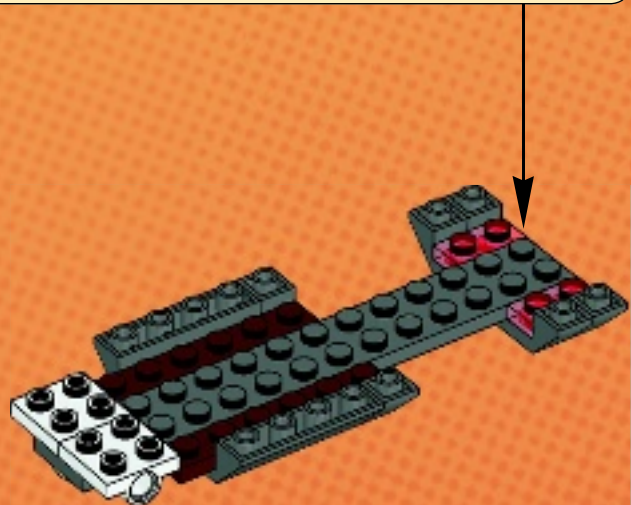
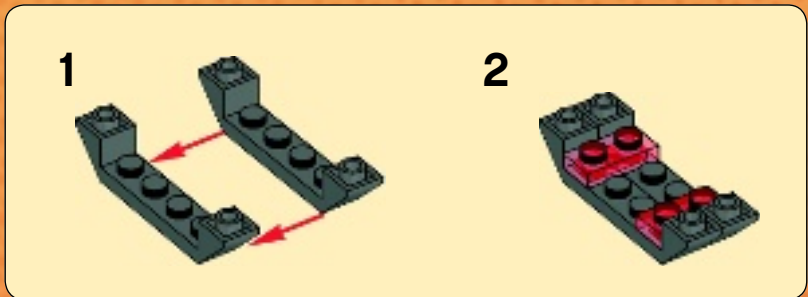



5

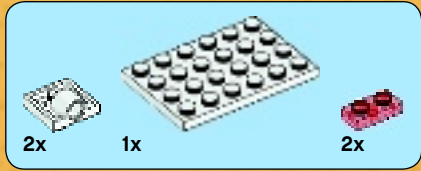
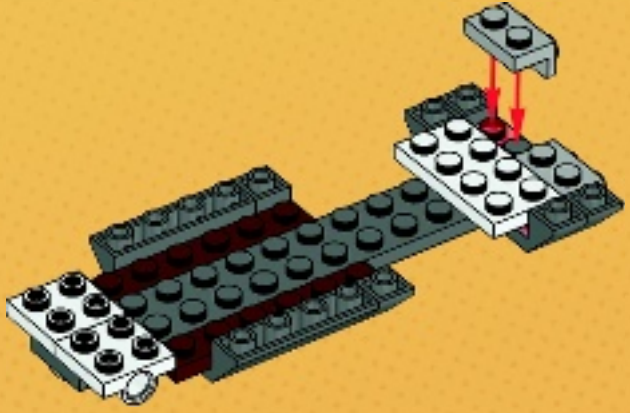

6

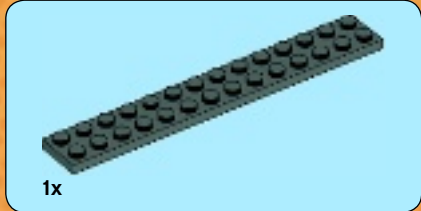
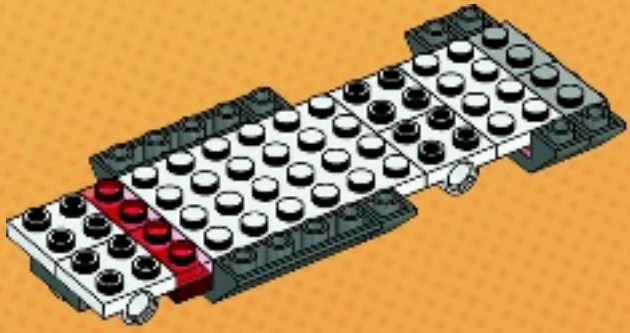

7

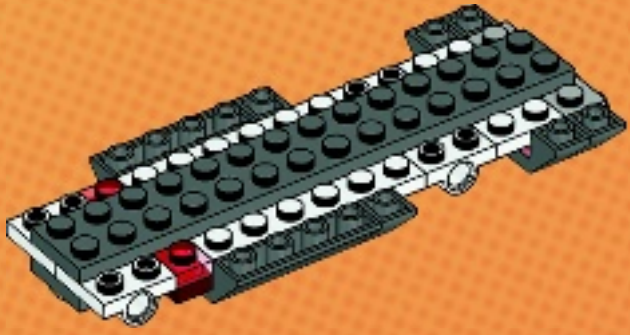



8

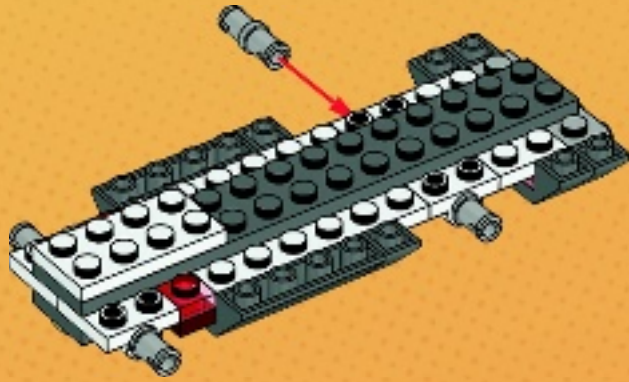

9

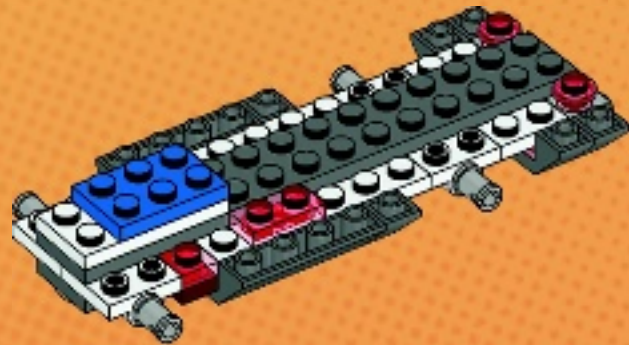

10

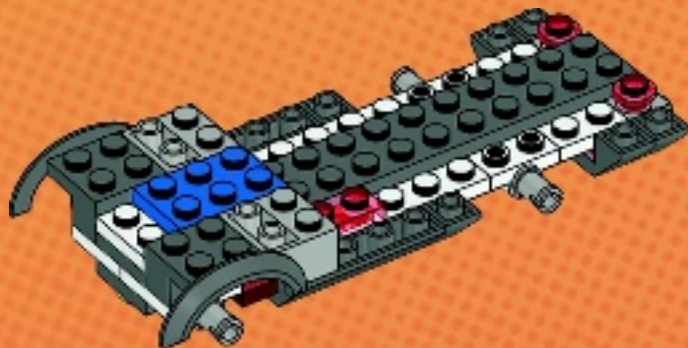



11

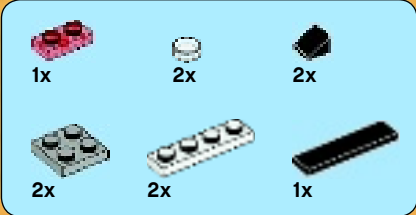
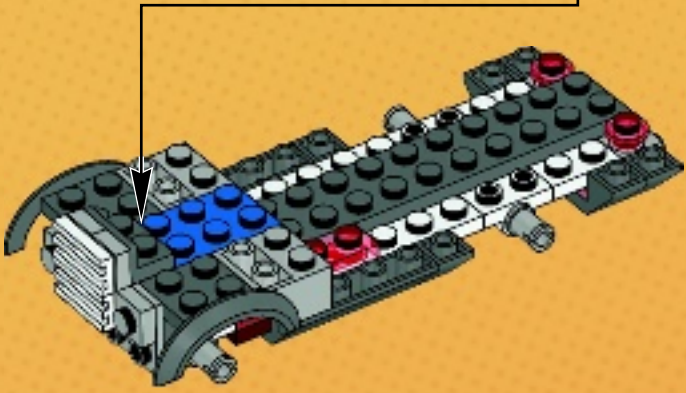
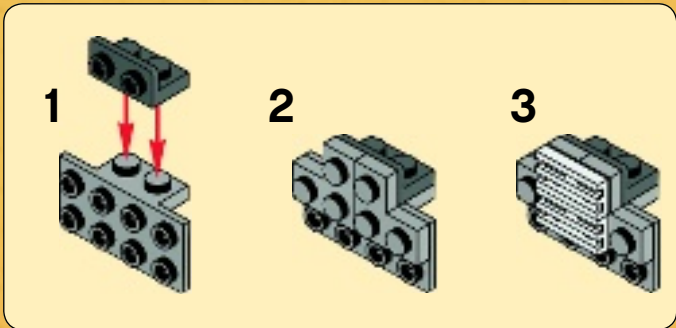

12

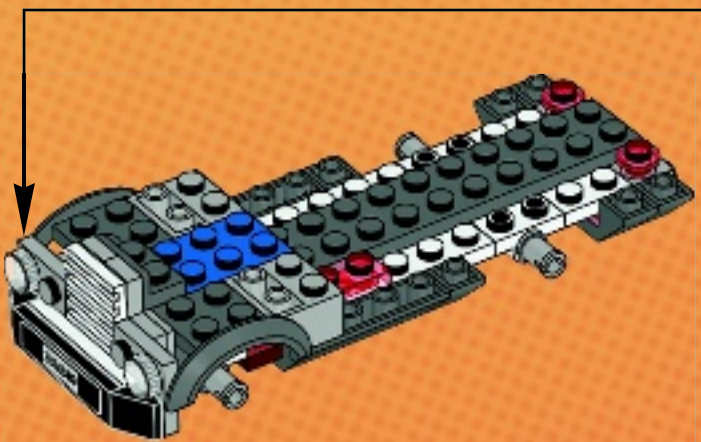
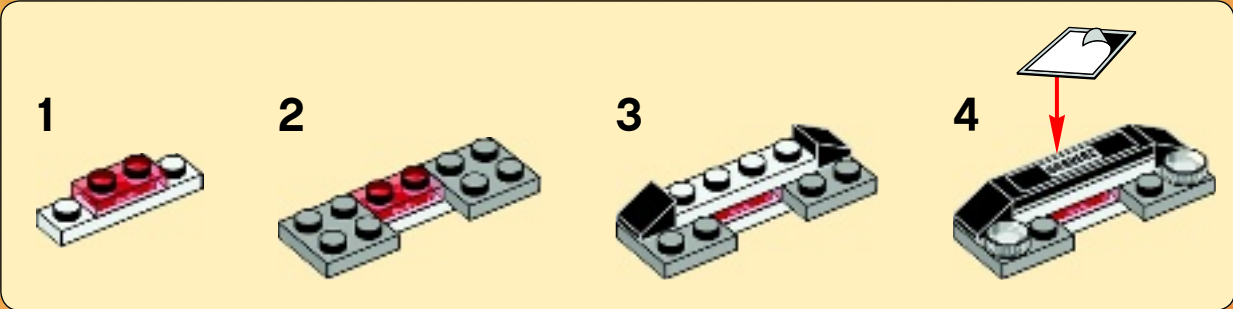

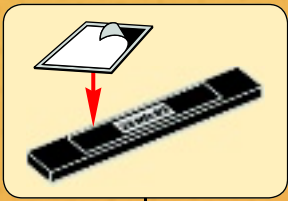
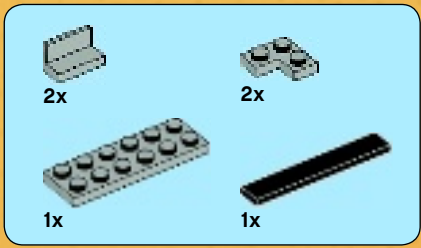

13

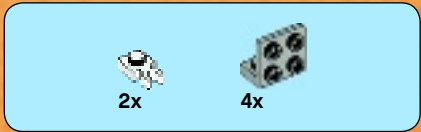
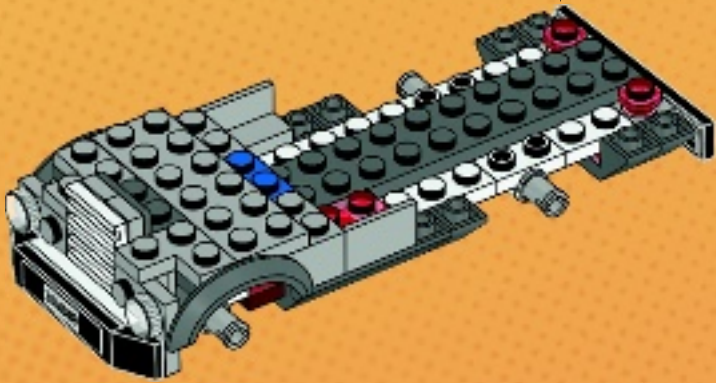

14

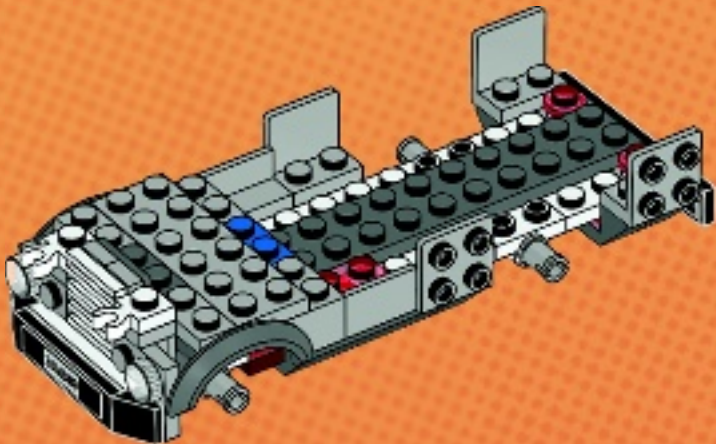



15

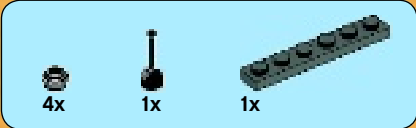
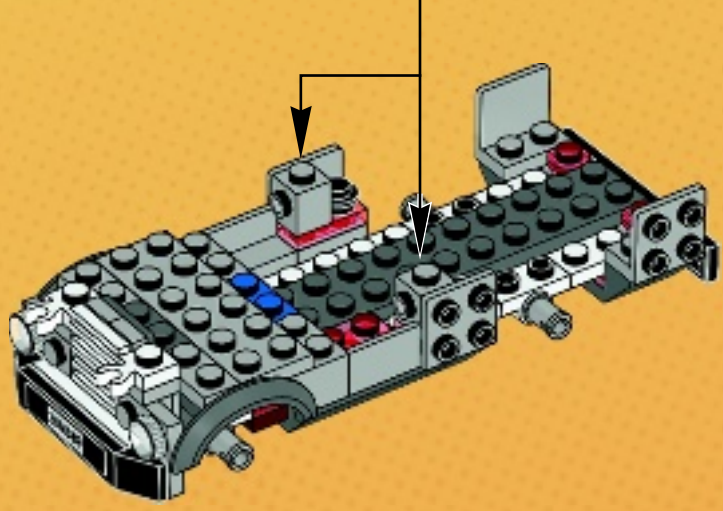
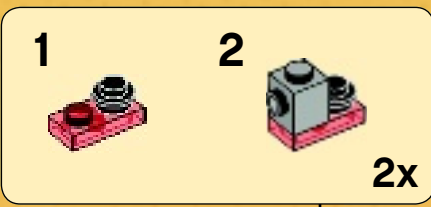

16

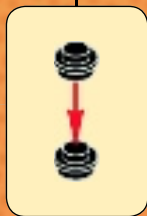
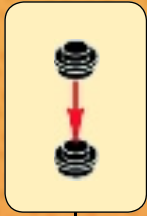

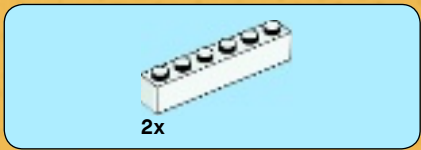

17

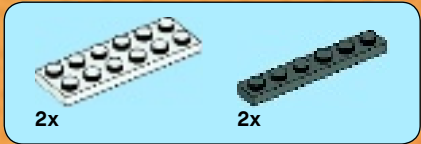
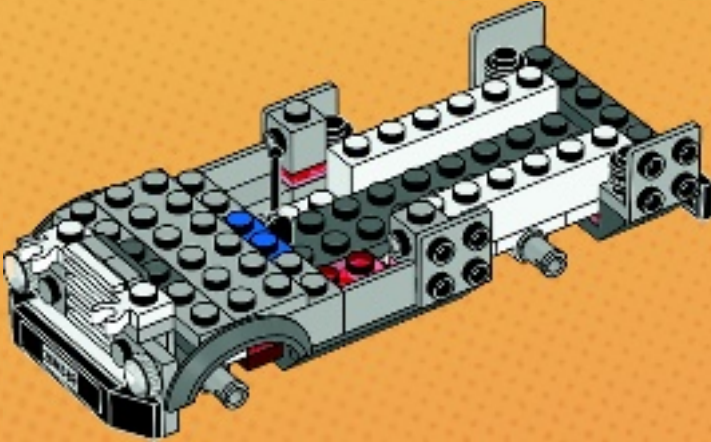

18

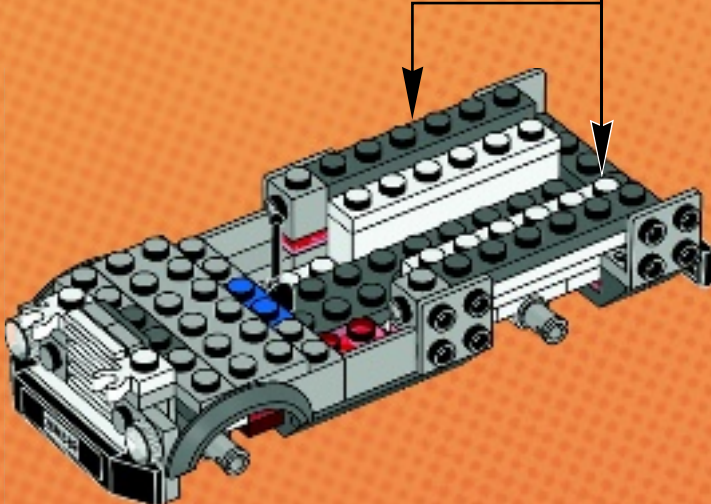
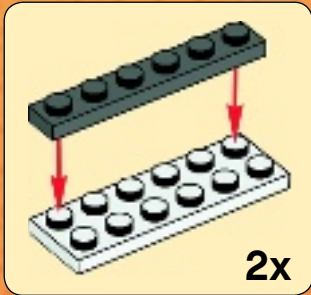

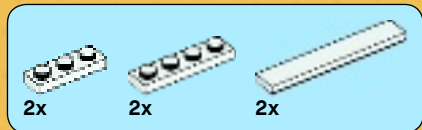

19

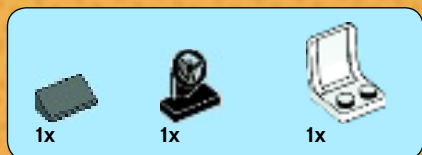
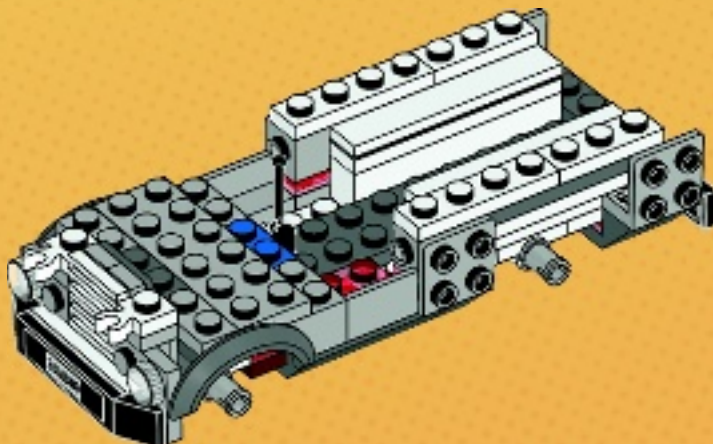

20

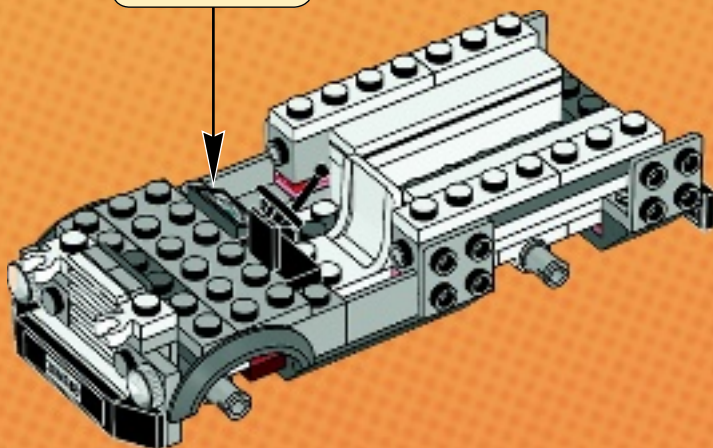
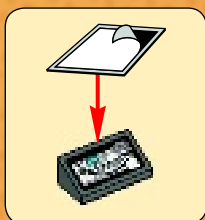

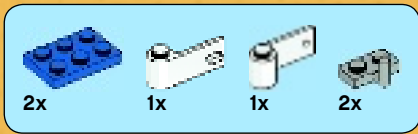

21

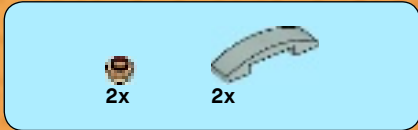
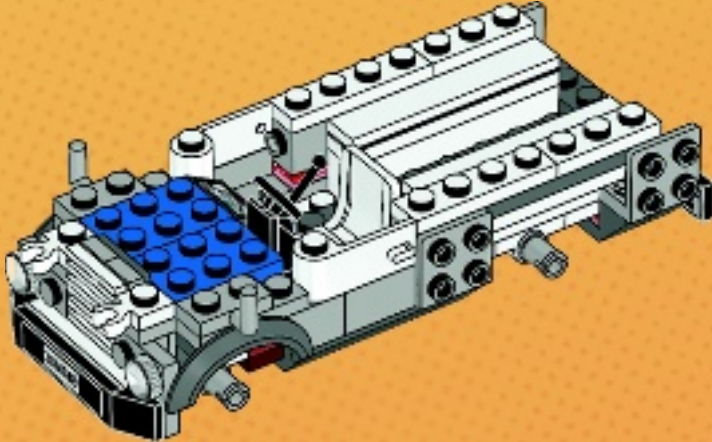

22

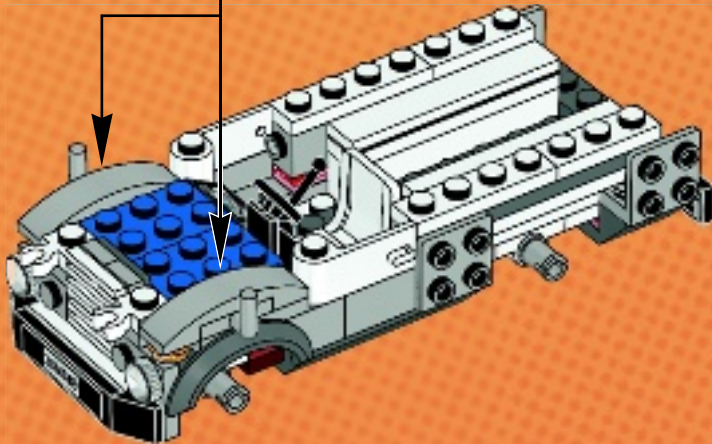
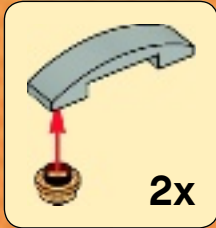

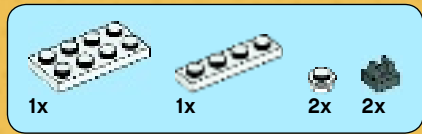

23

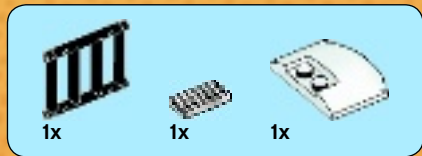
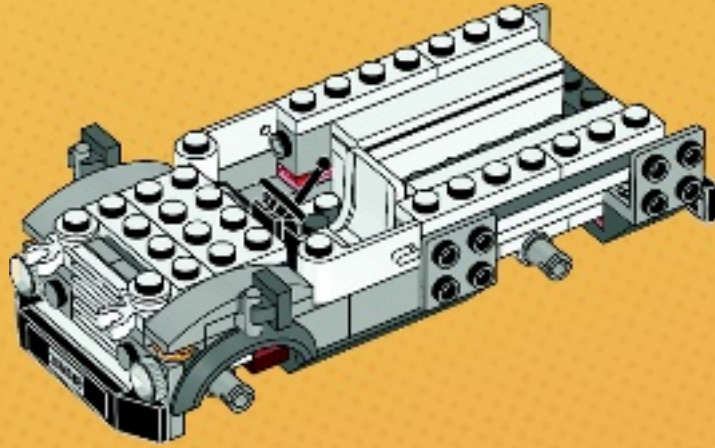

24

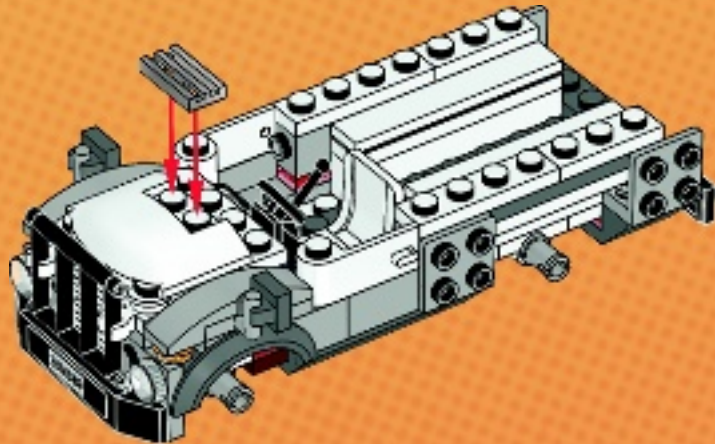

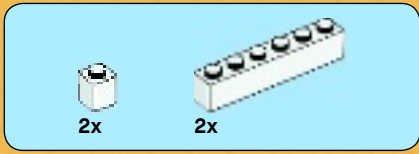

25

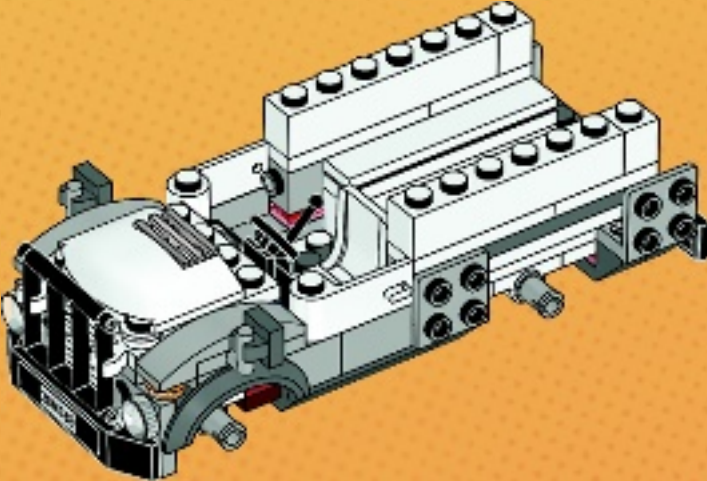

26

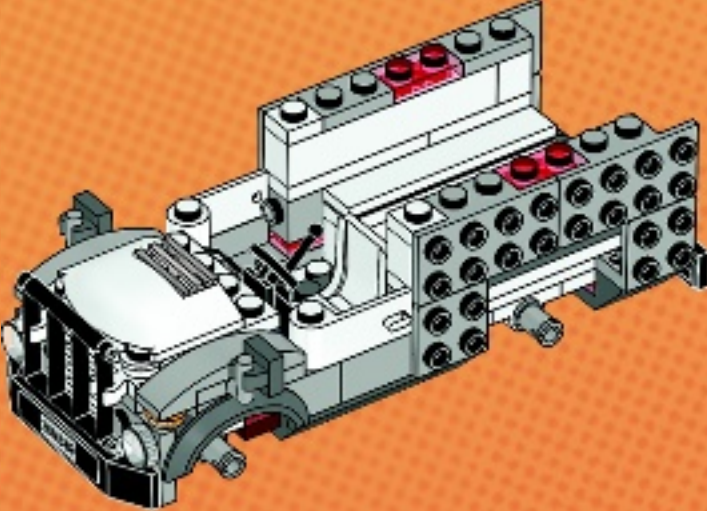

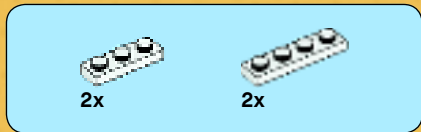

27

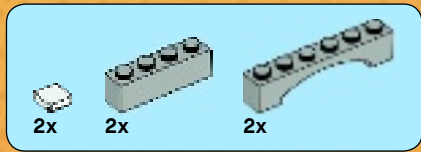
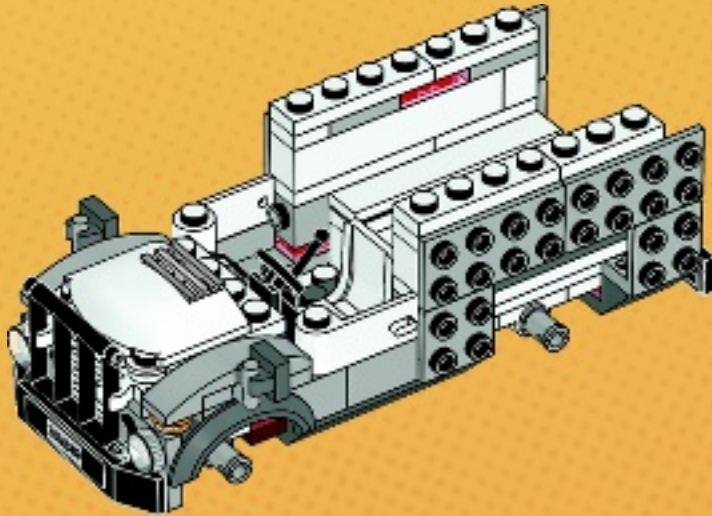

28

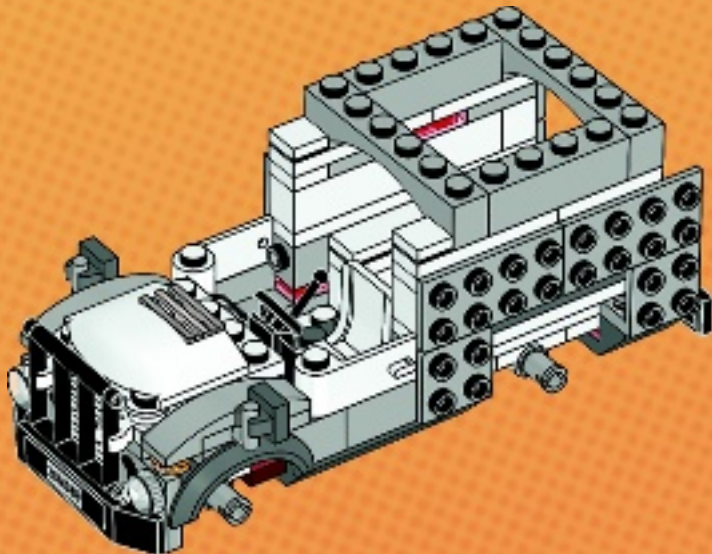

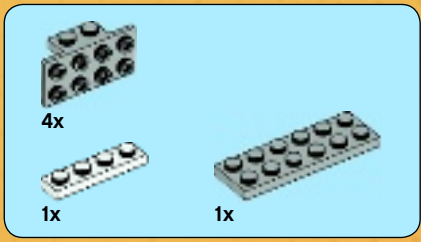

29

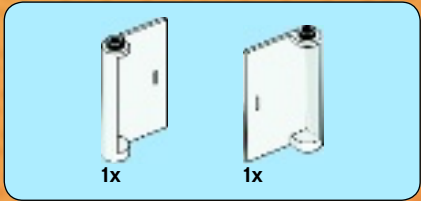
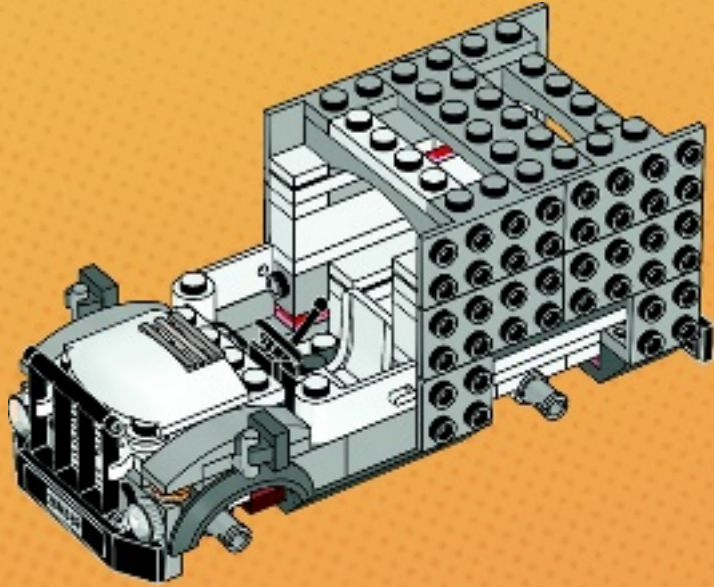

30

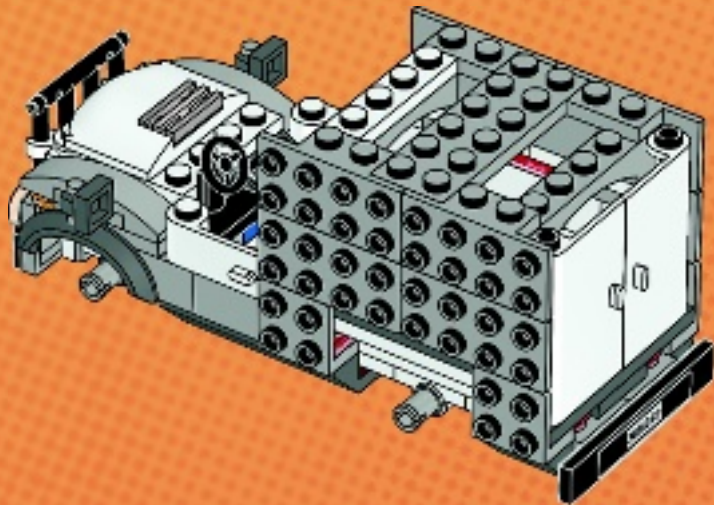



1x

31

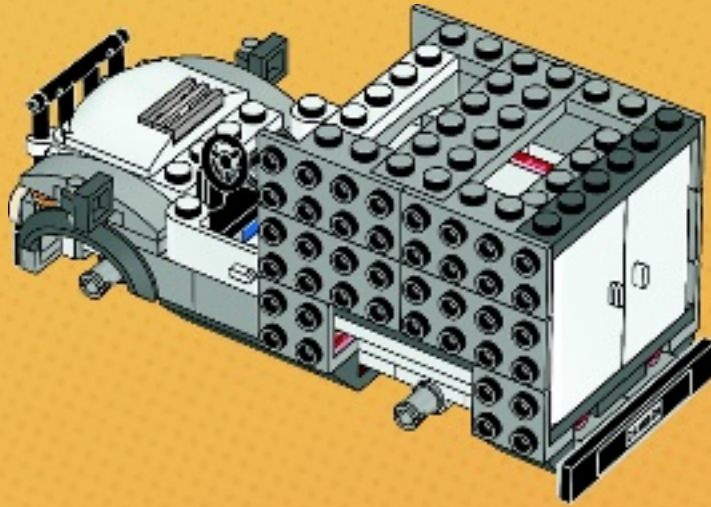

4x

32

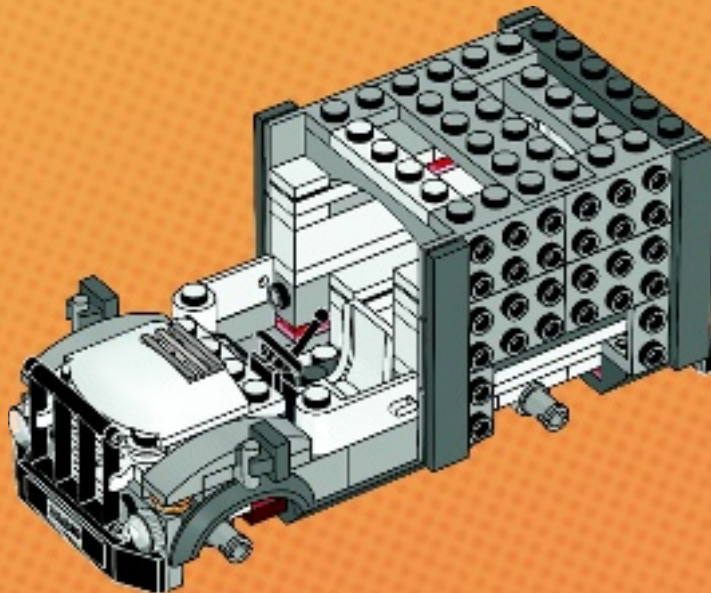



33

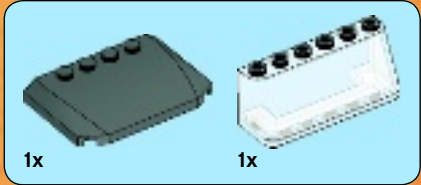
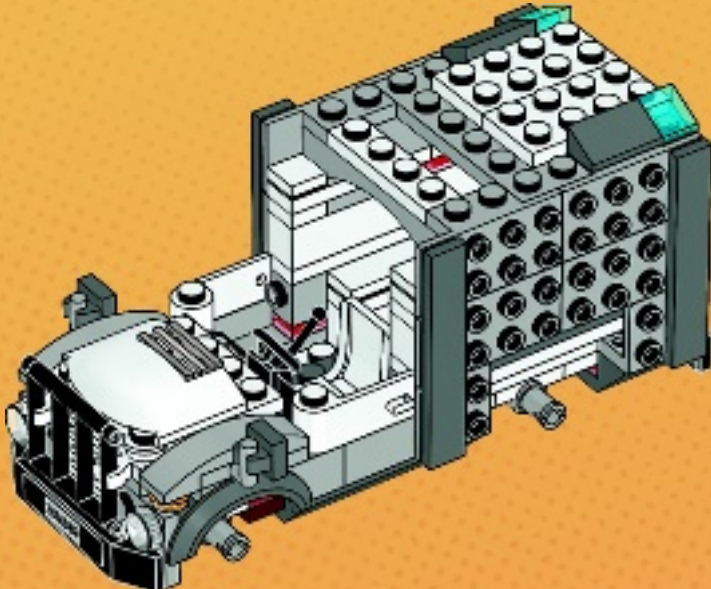

34

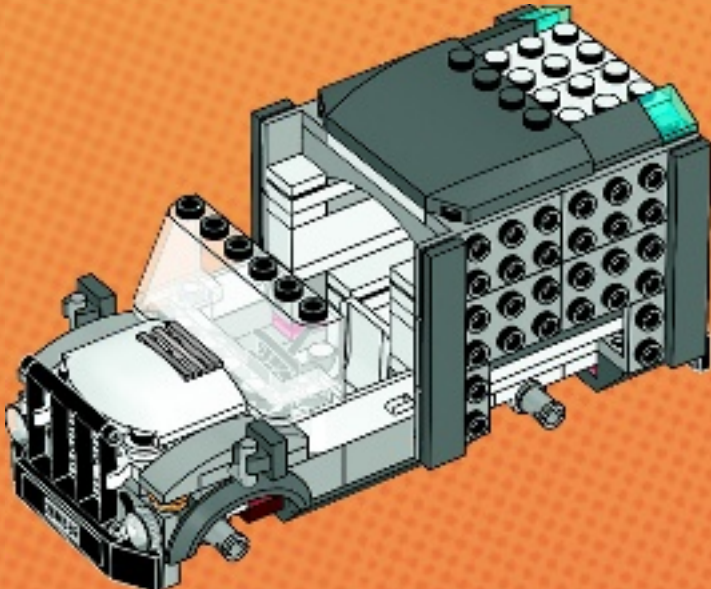



35

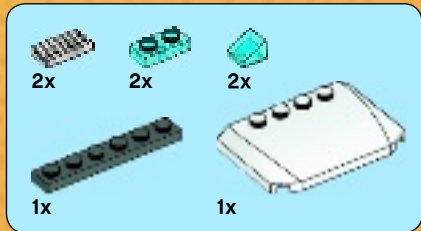
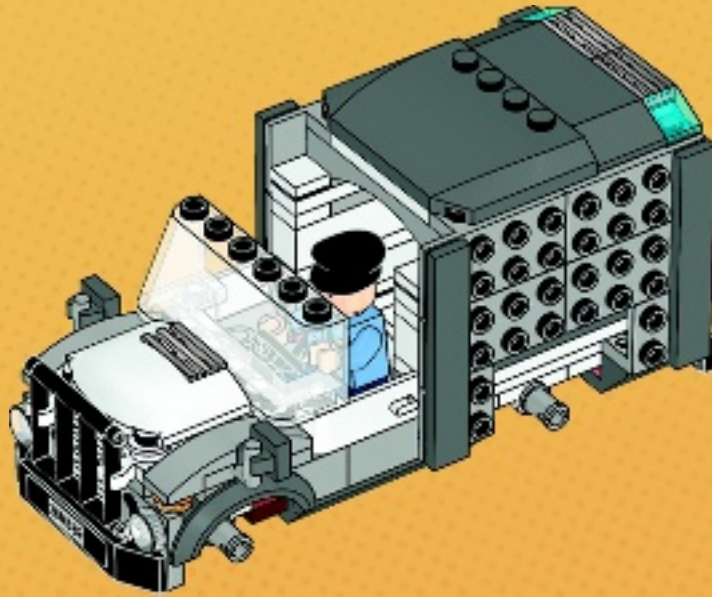

36

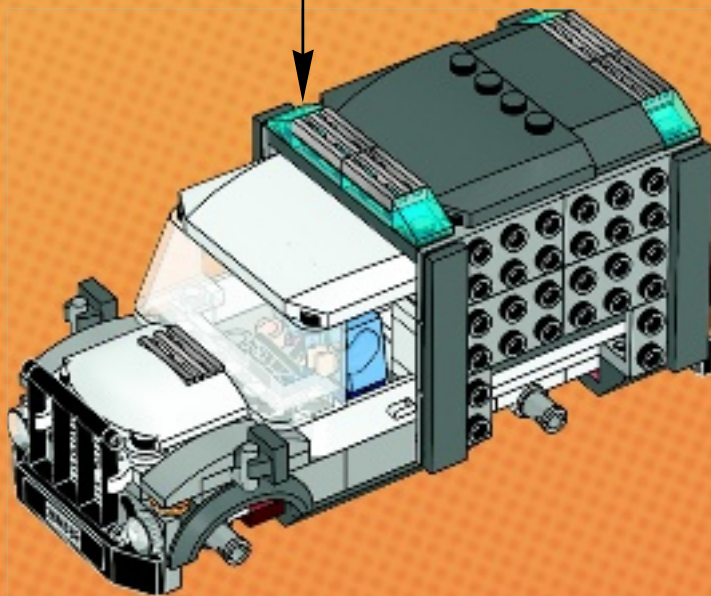

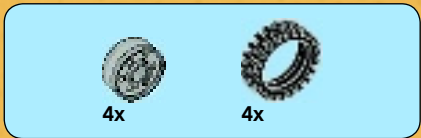

37

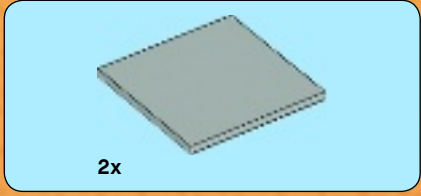
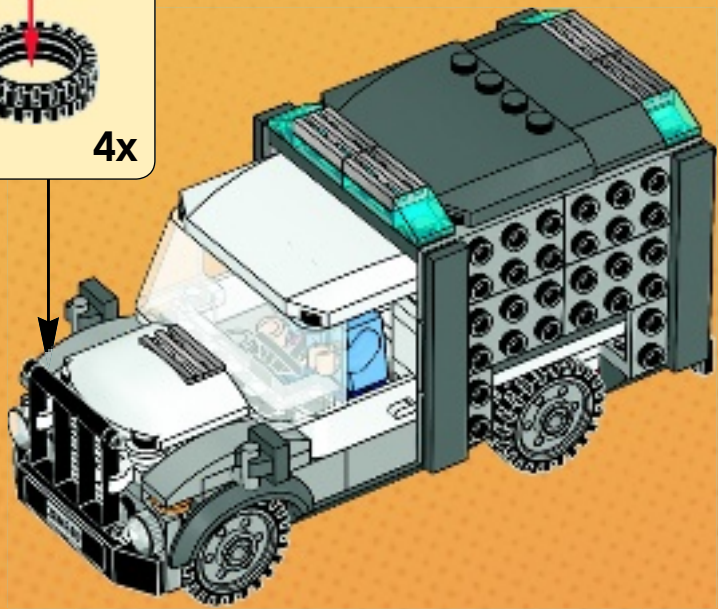

38

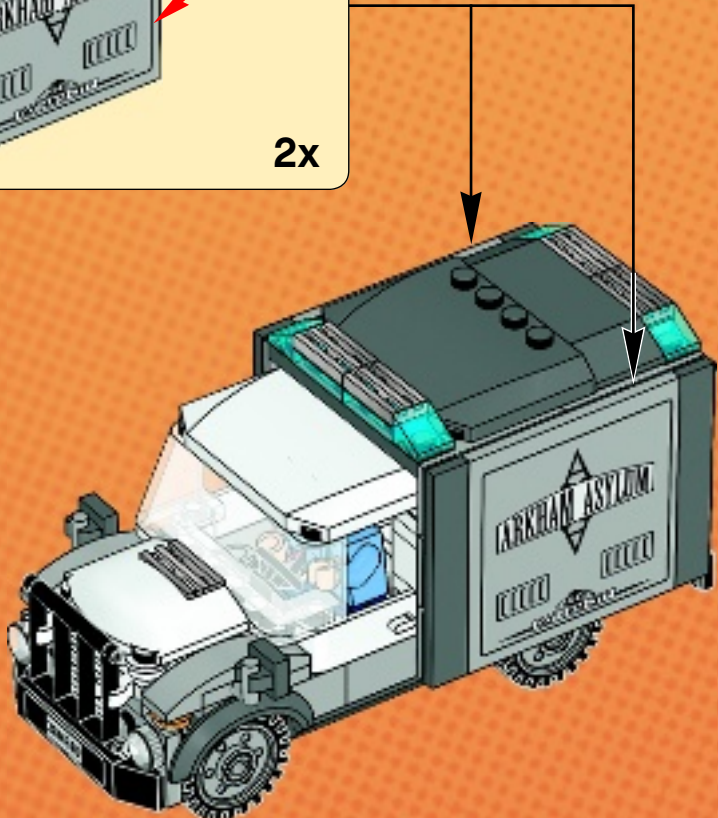
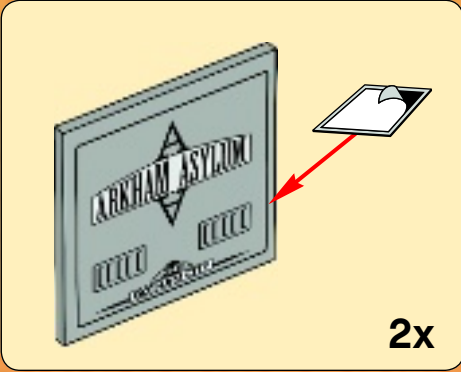



1x

1



6x

2

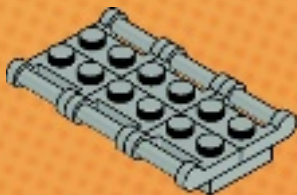

2x



1x

3



4x

4

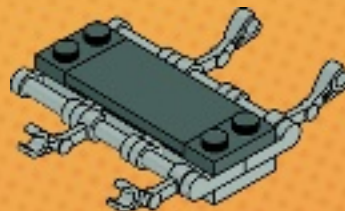

2x

5

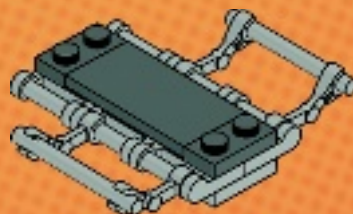



6



7



39

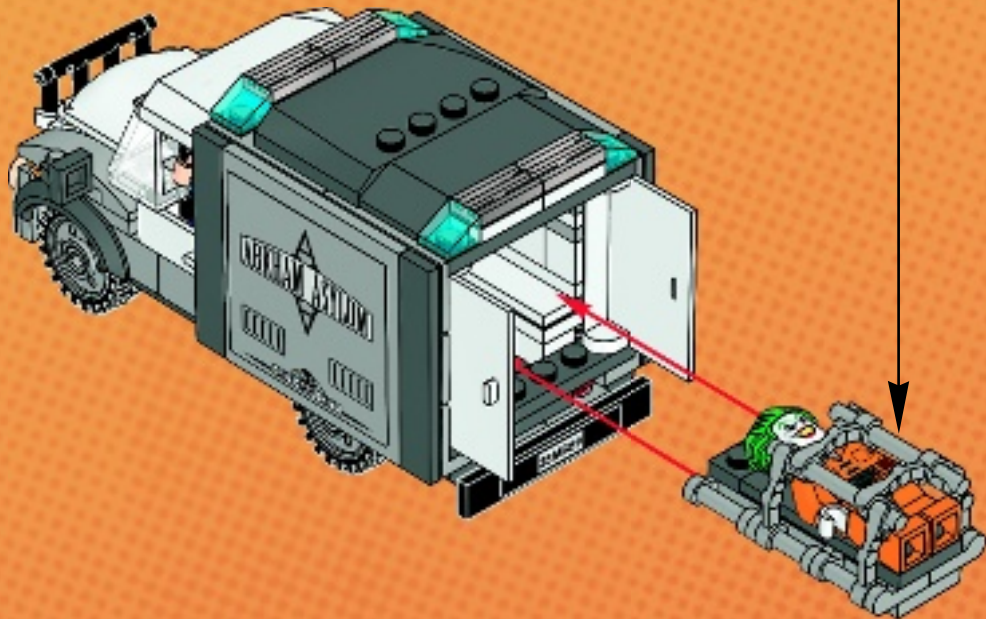

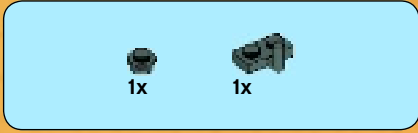
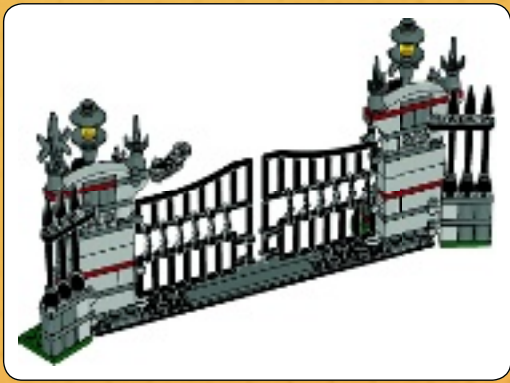

1

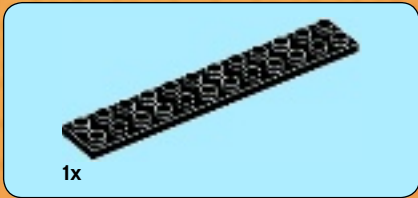
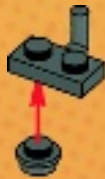

2

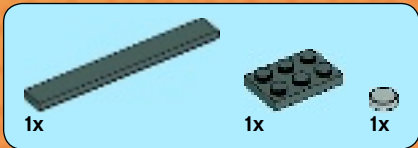

3

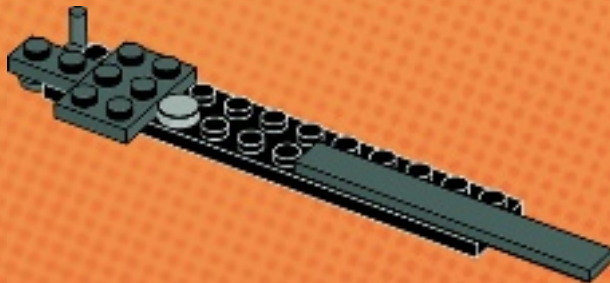

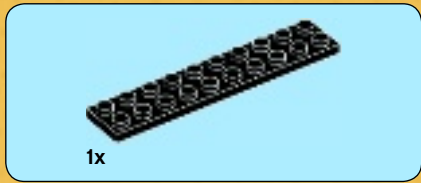

4

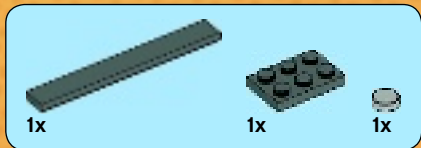
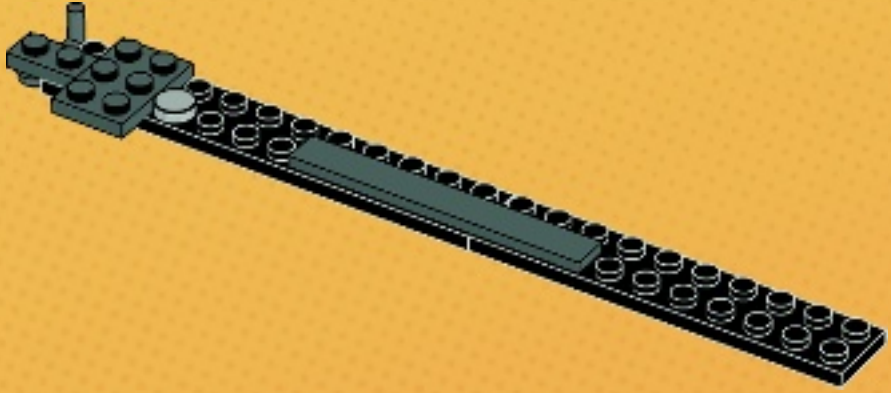

5

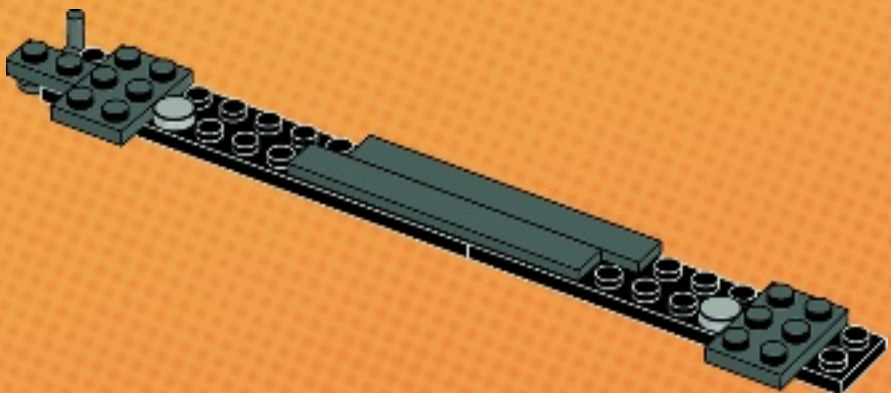

1x 1x

6

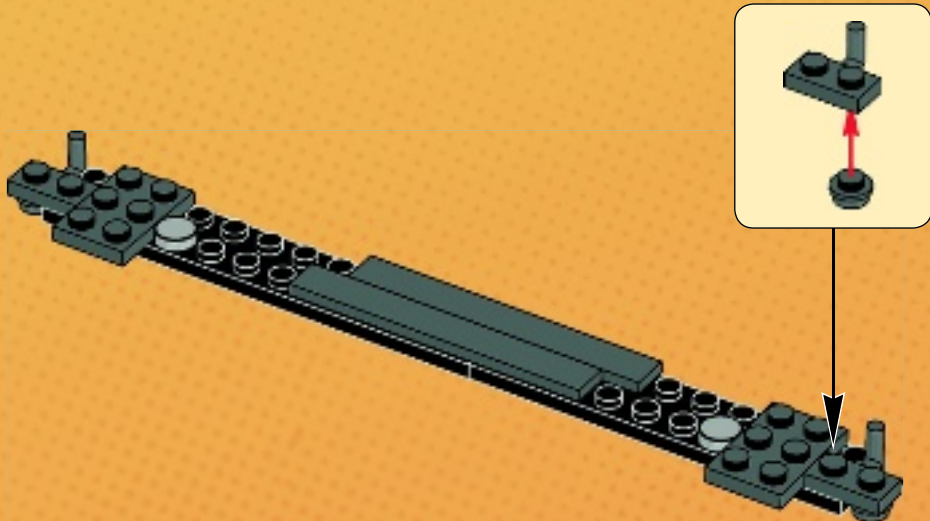

4x

7

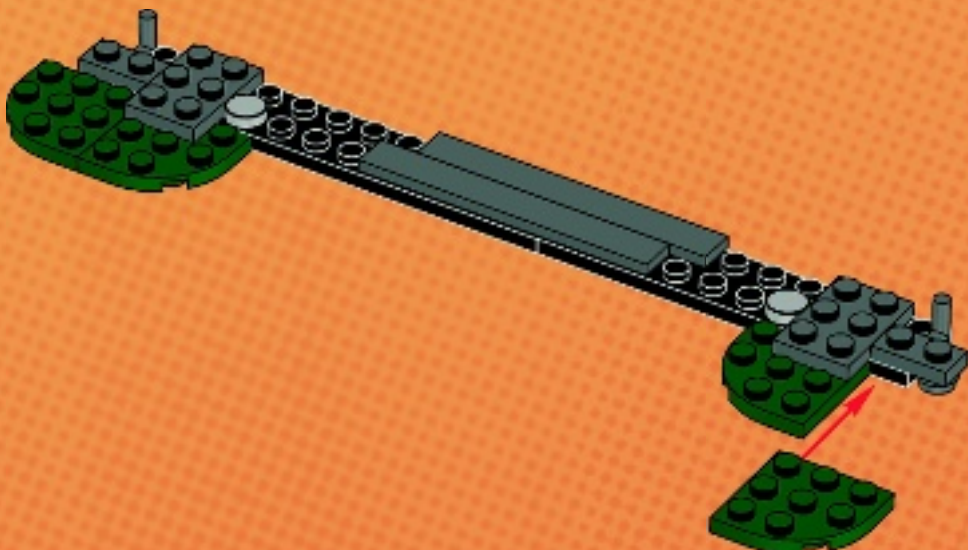



8

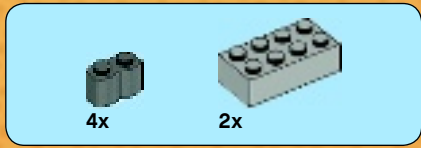
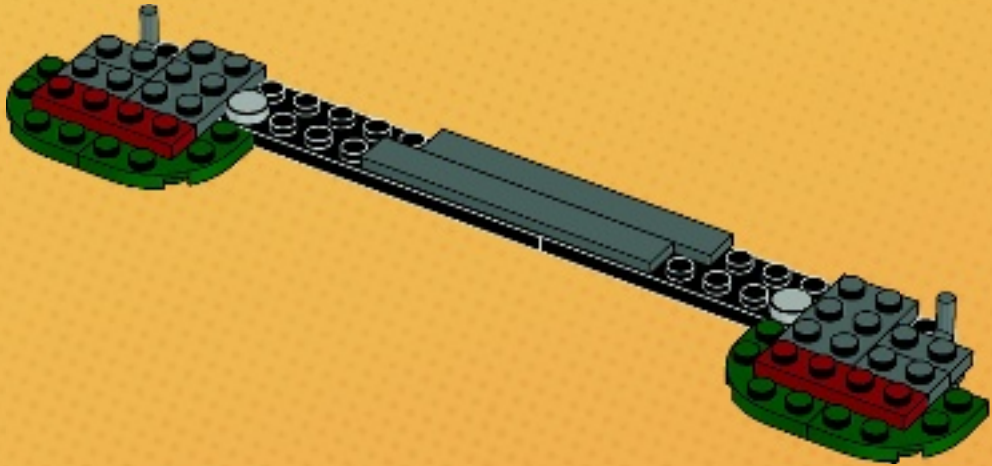

9

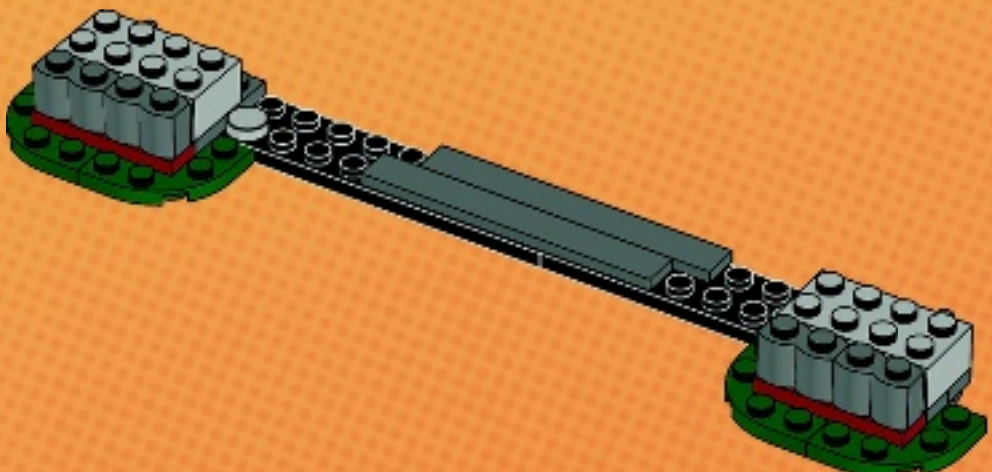



10

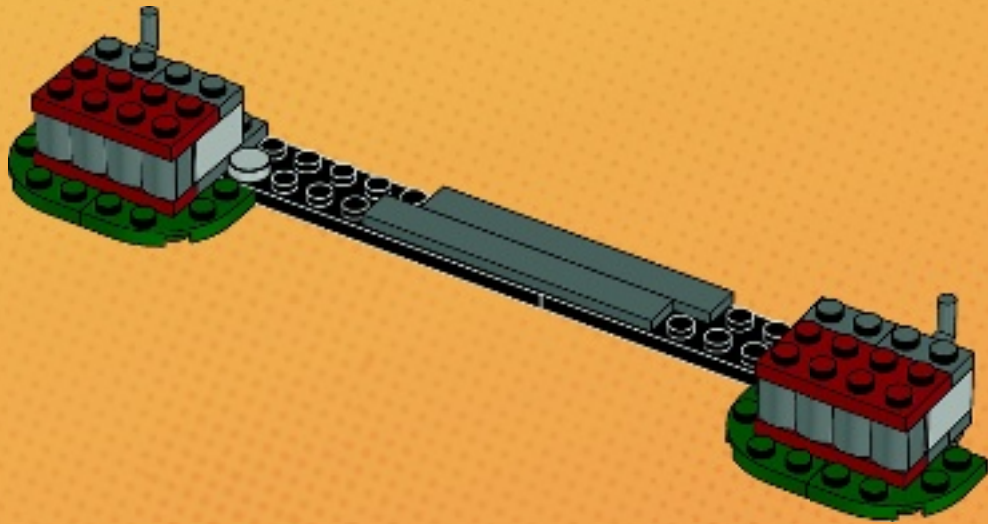

11

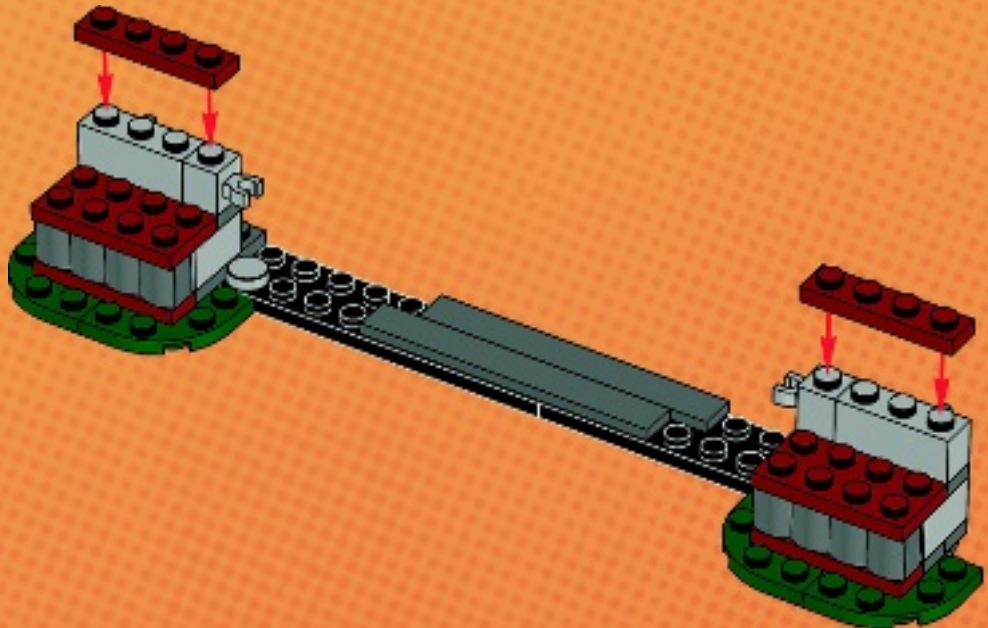



4x

12

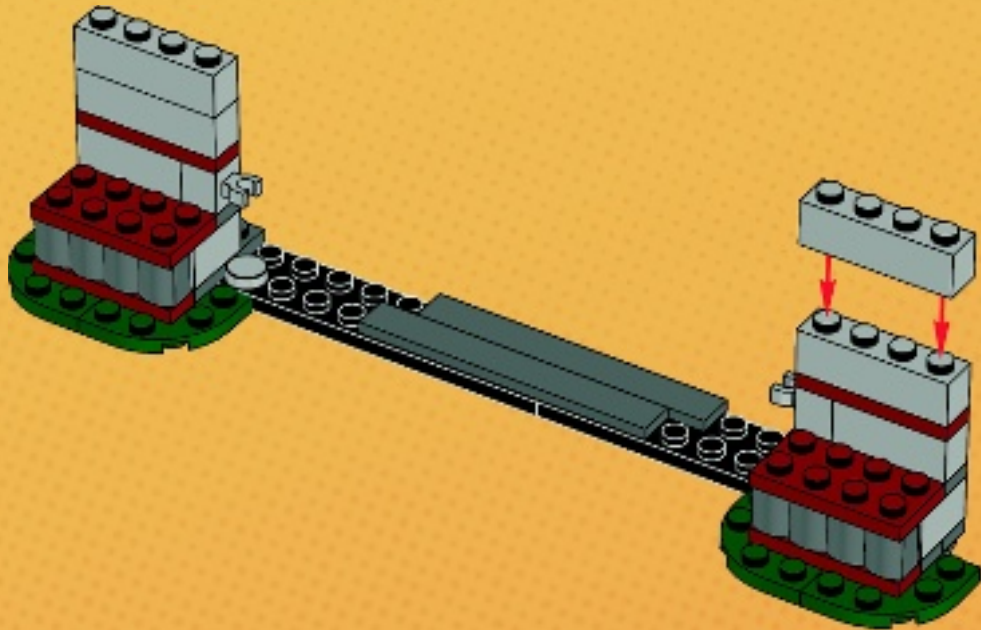

4x

13

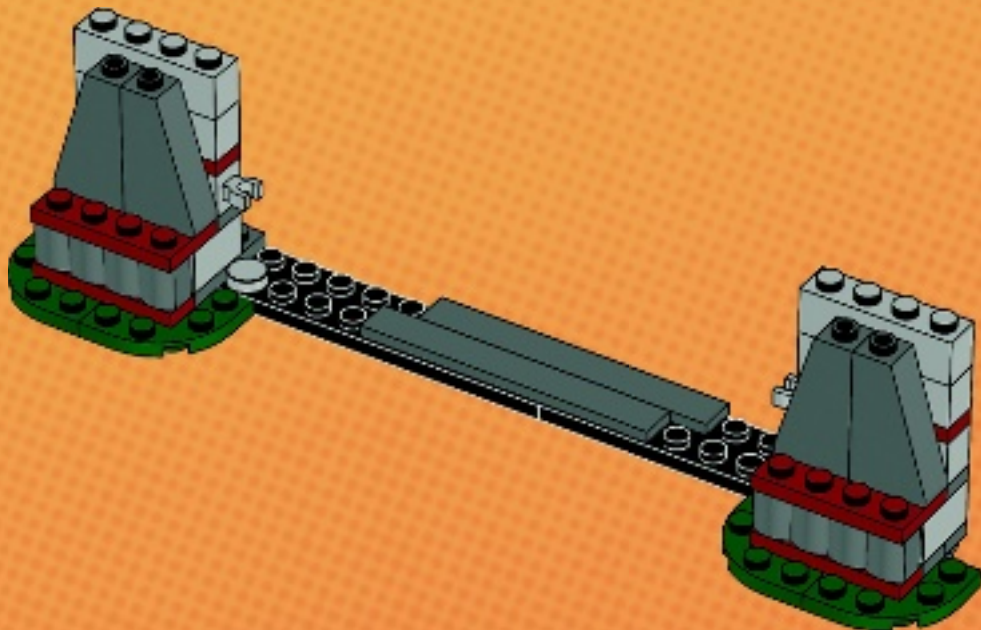



4x



2x

14

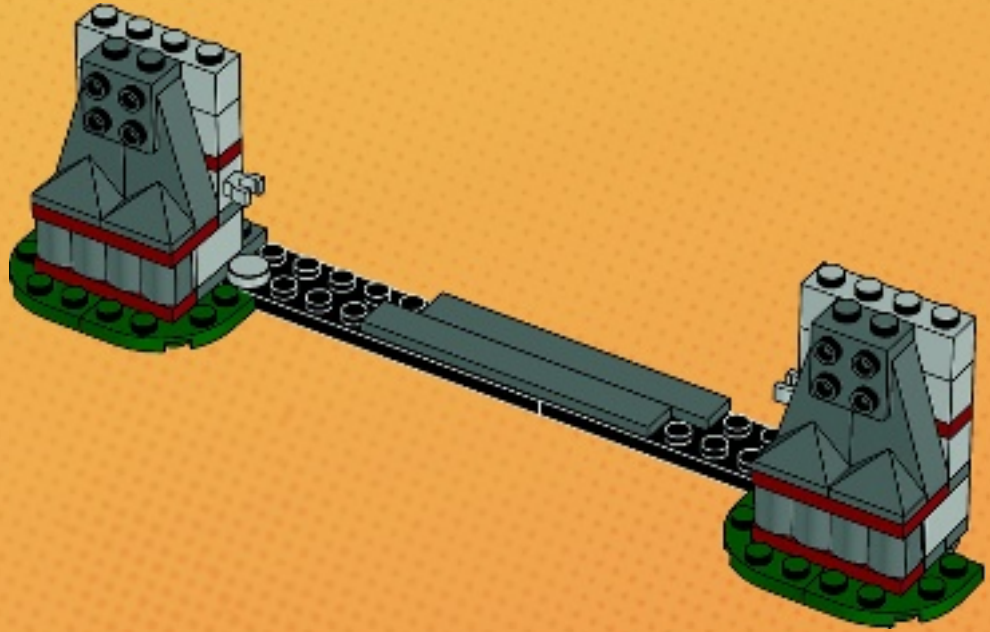

2x

15

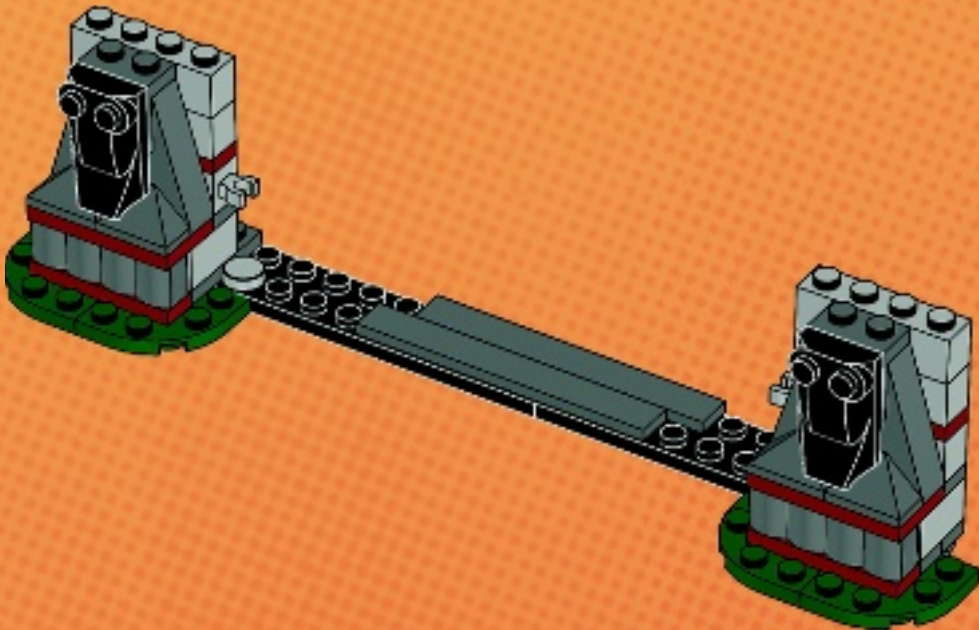

2x 2x 2x

16

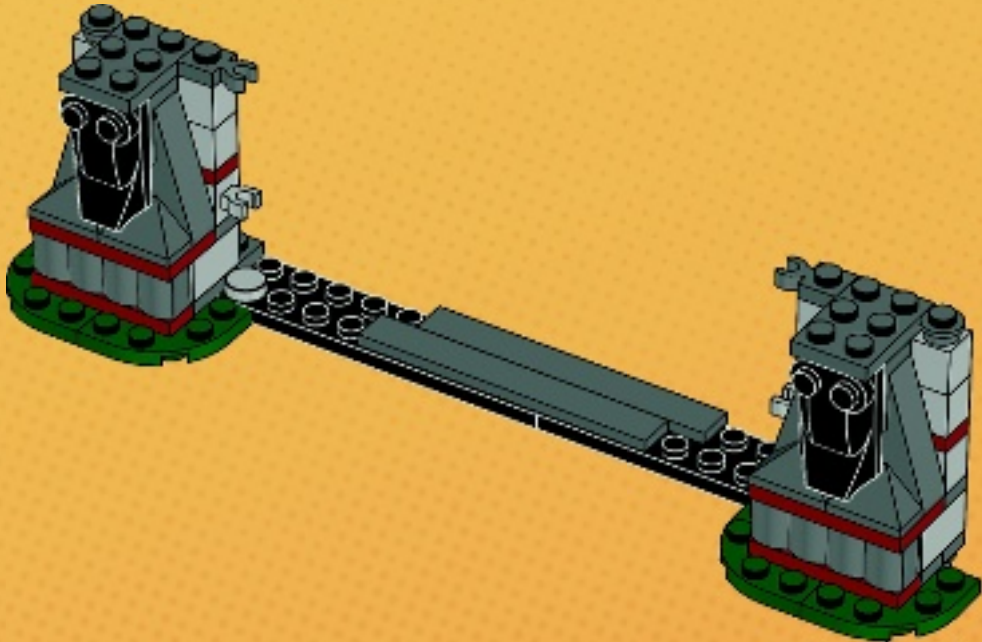

4x 4x

17

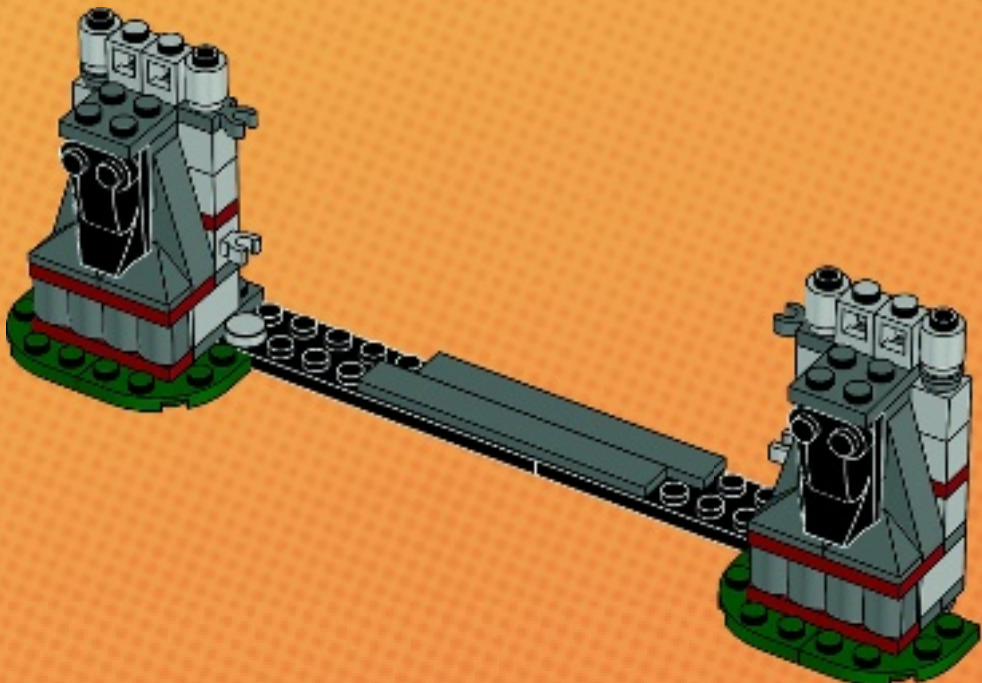



2x



2x

18

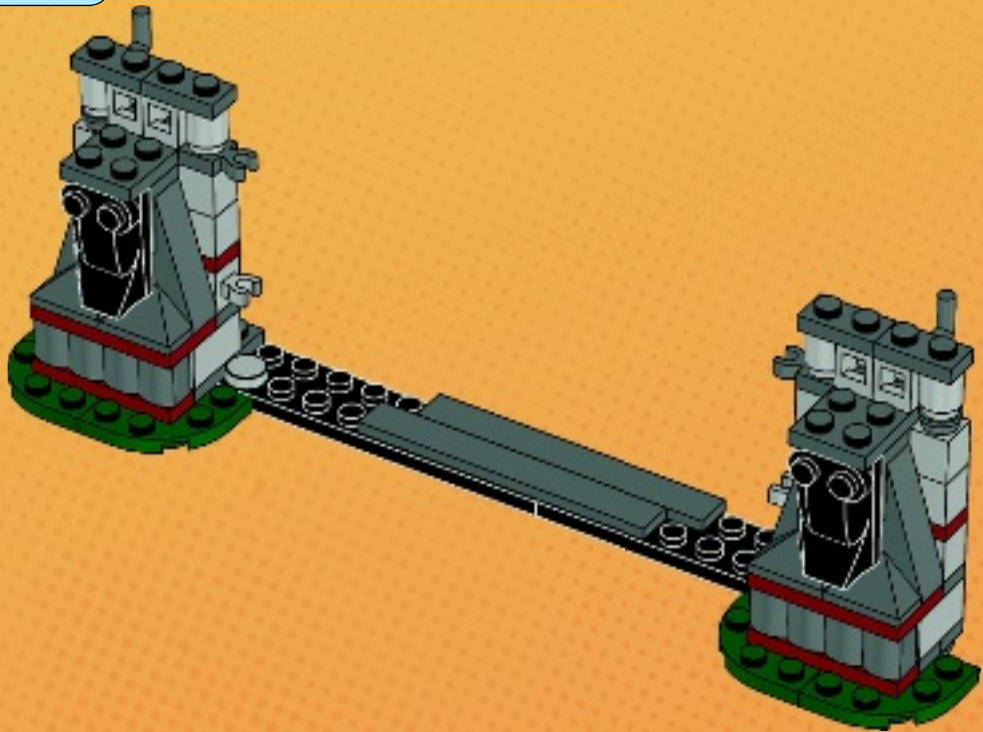

2x



4x

19

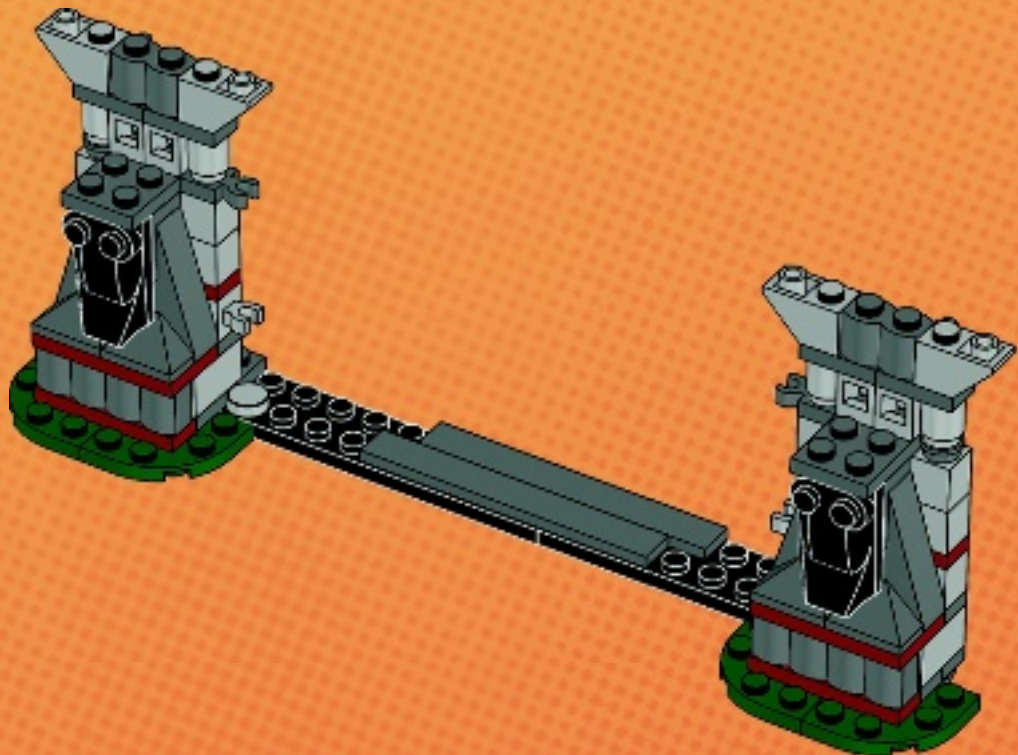

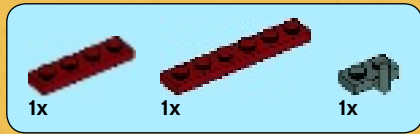

20

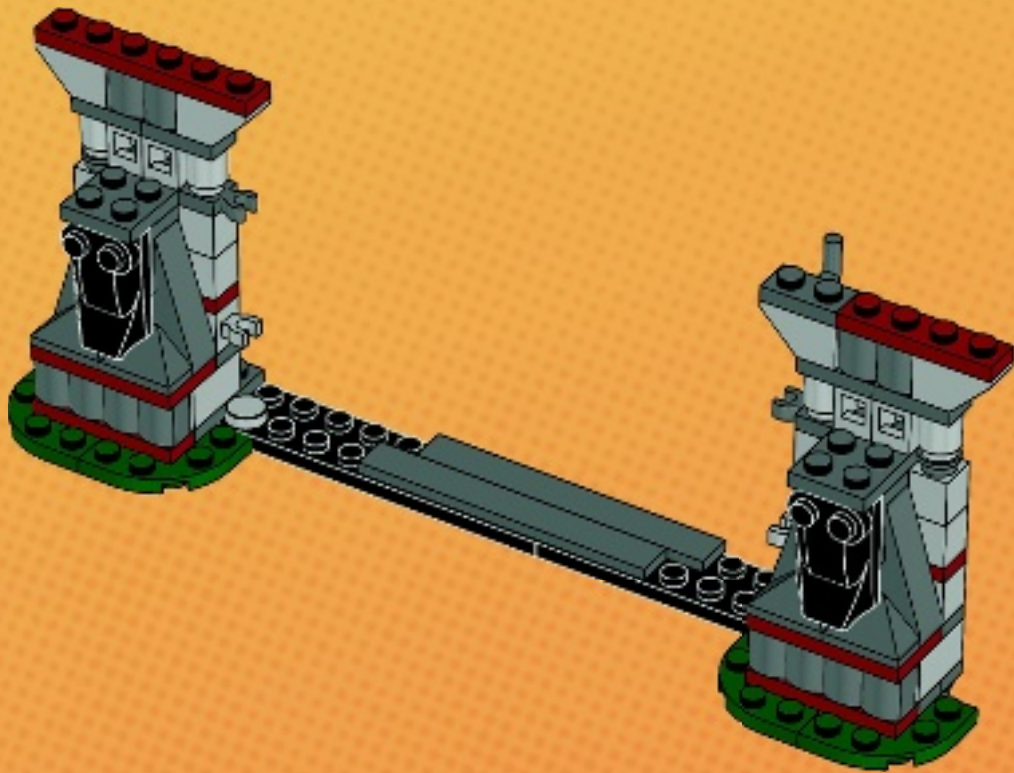



2x



2x

21

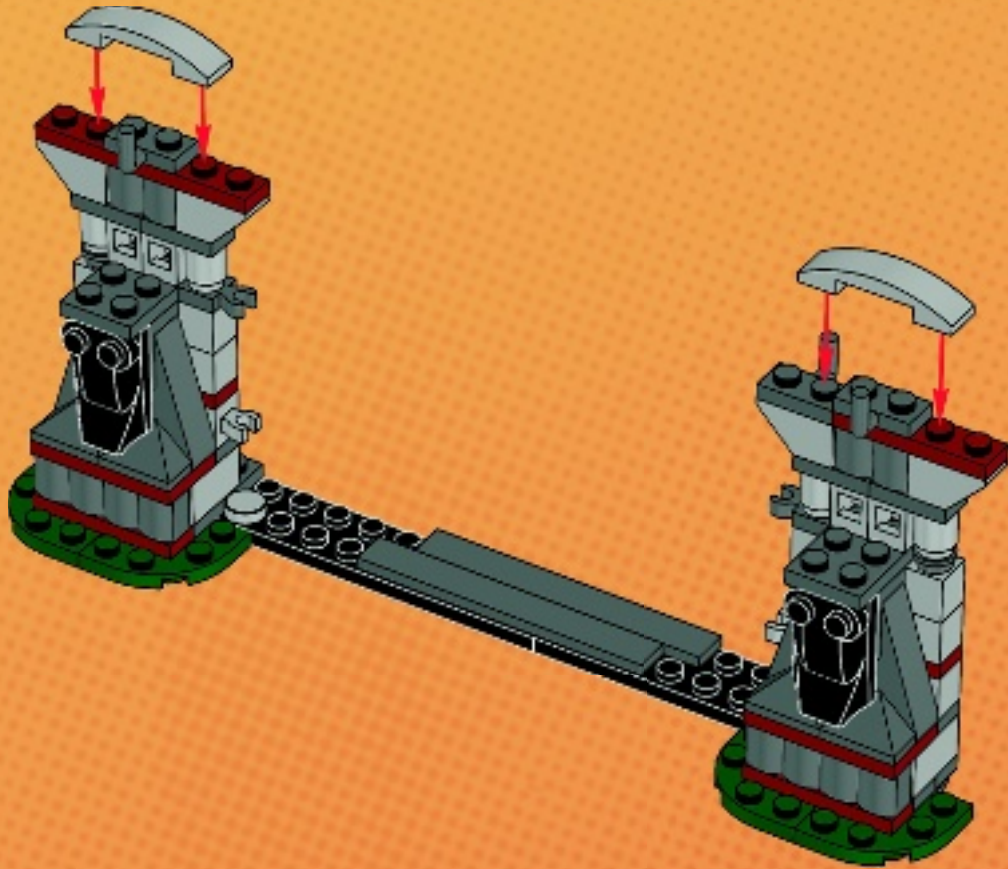



4x



4x

22

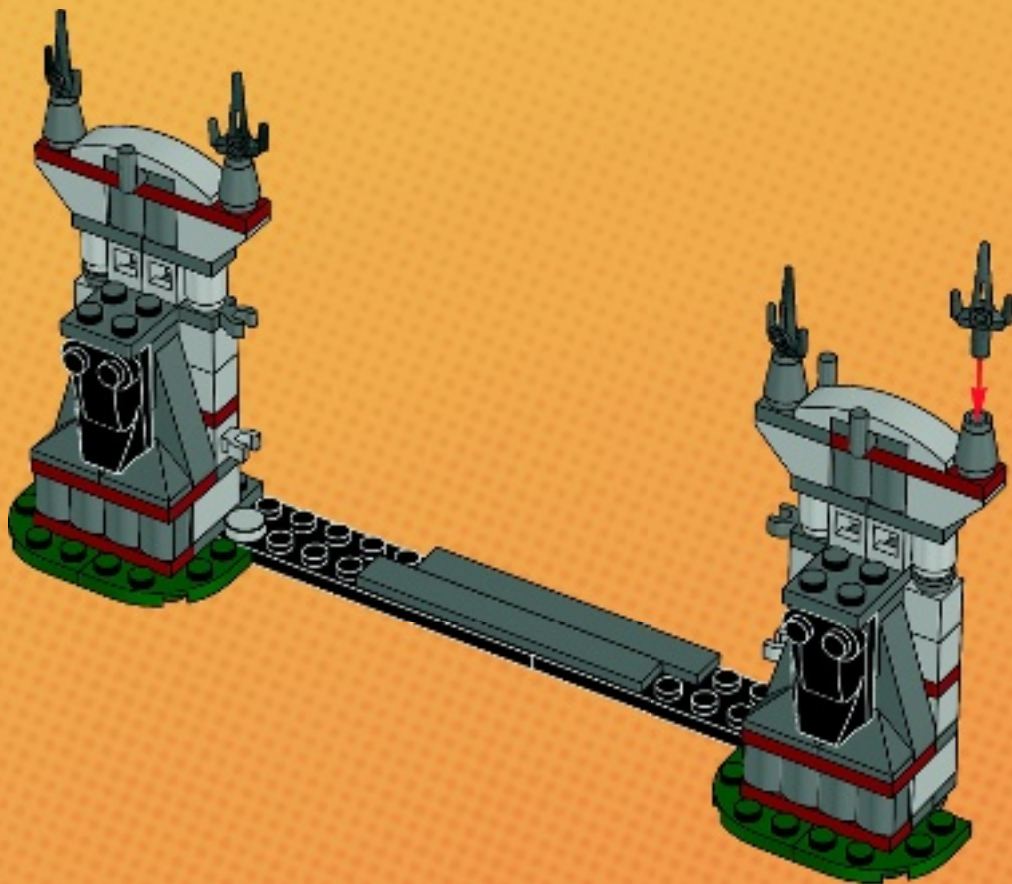



23

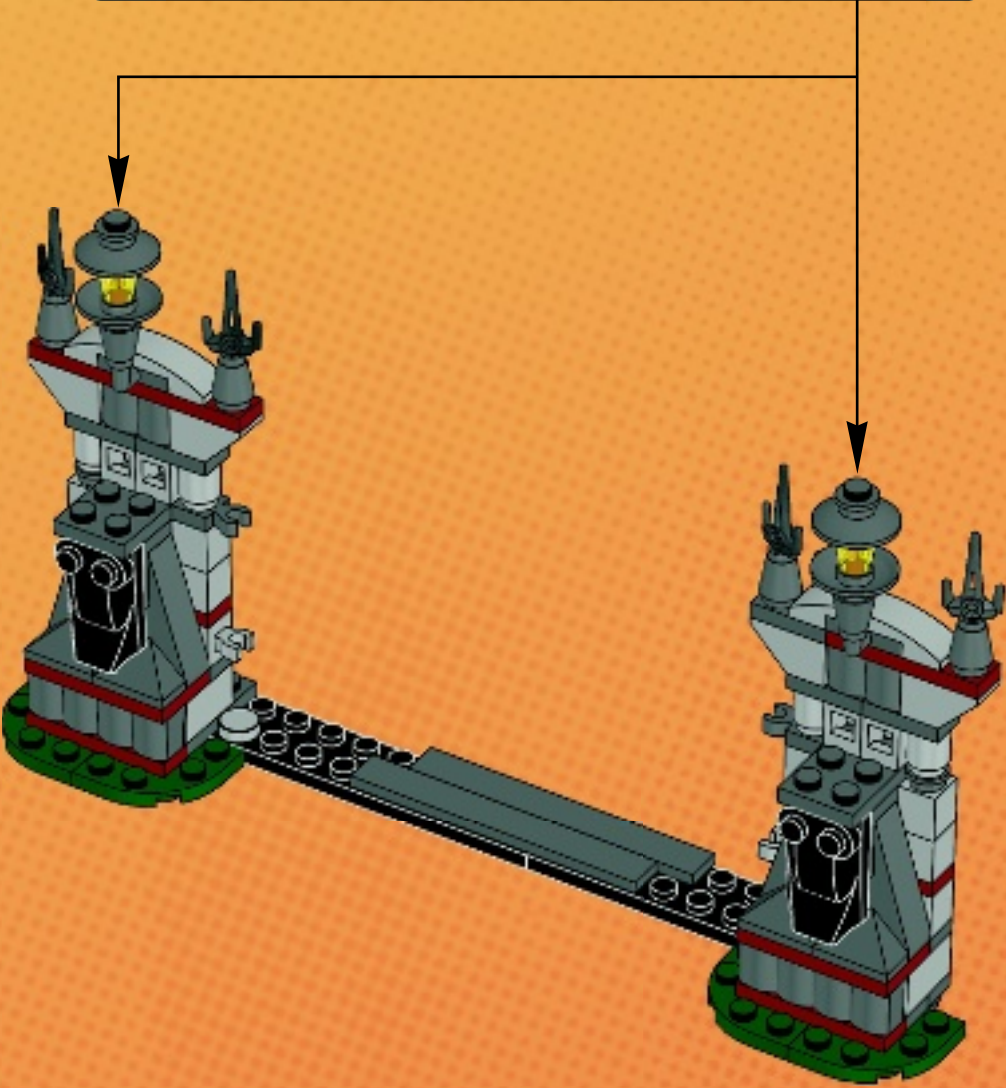
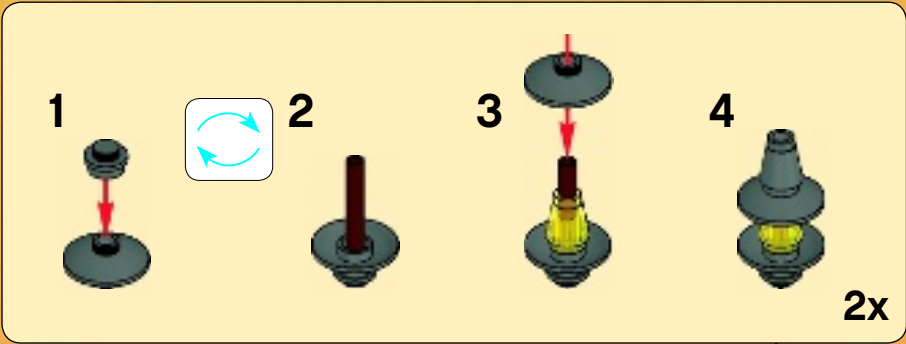

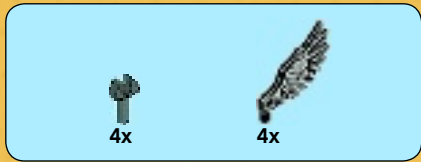

24

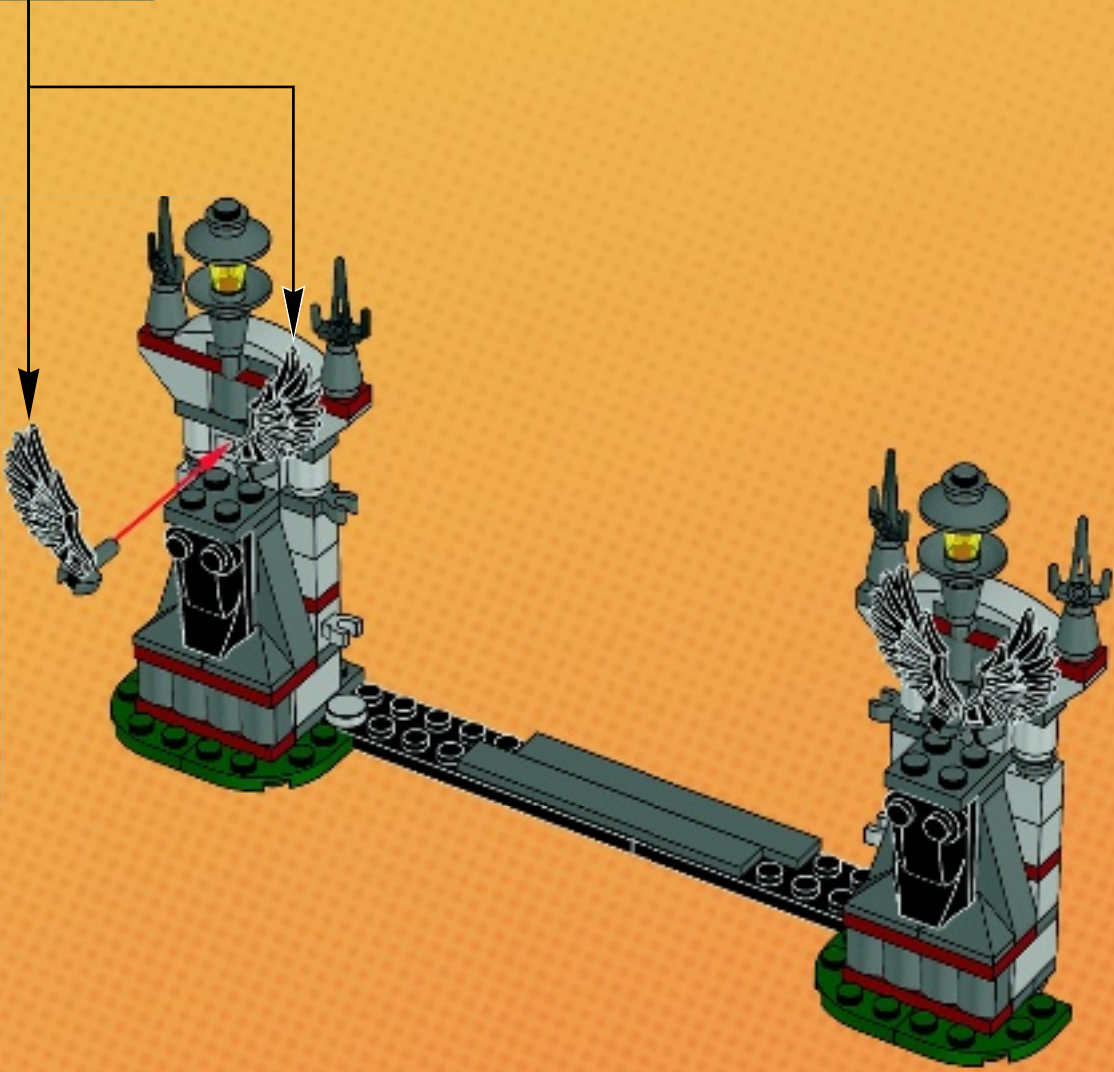
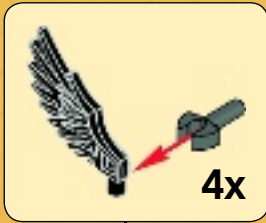



25

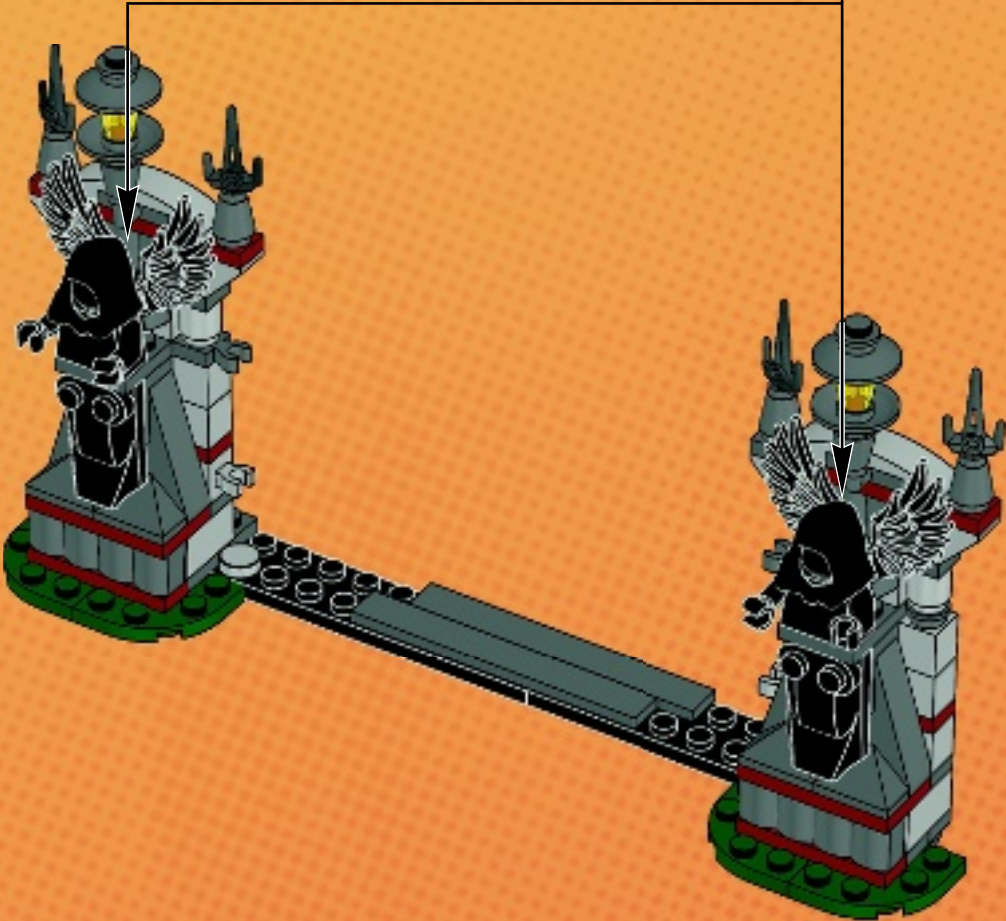
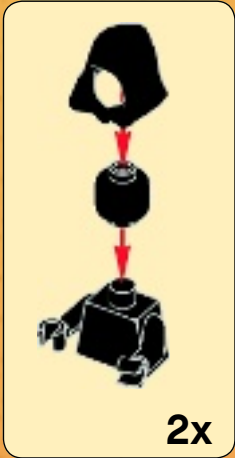

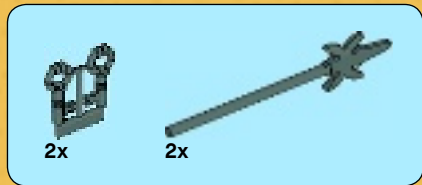

26



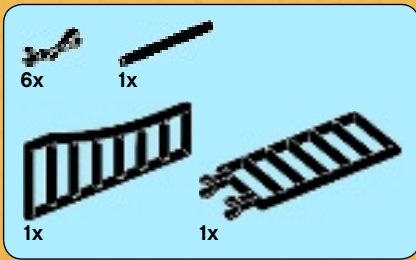

27

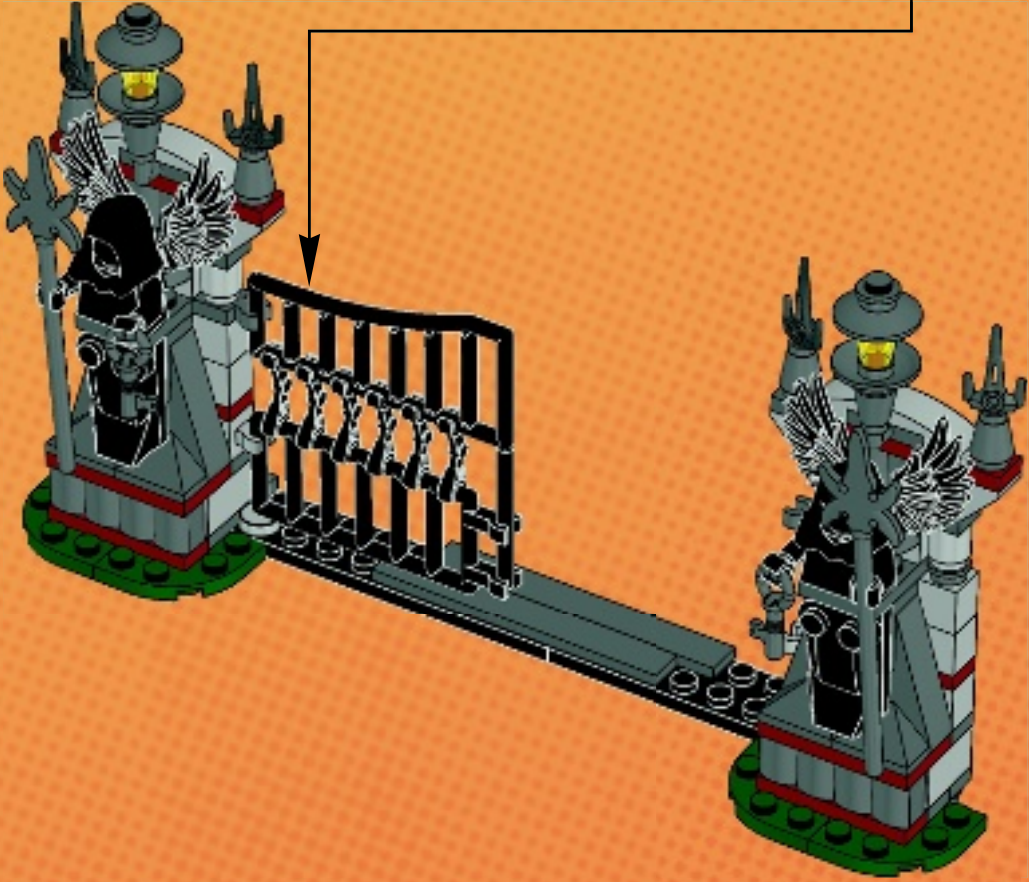
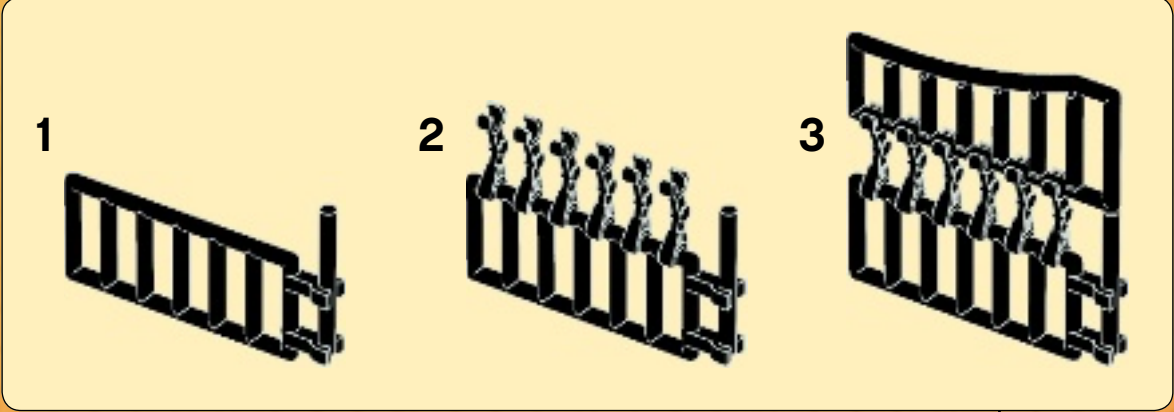

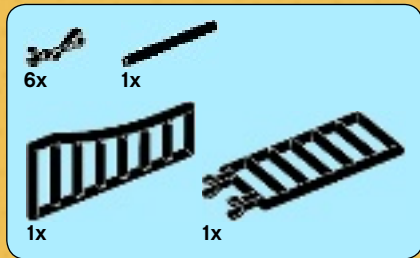

28

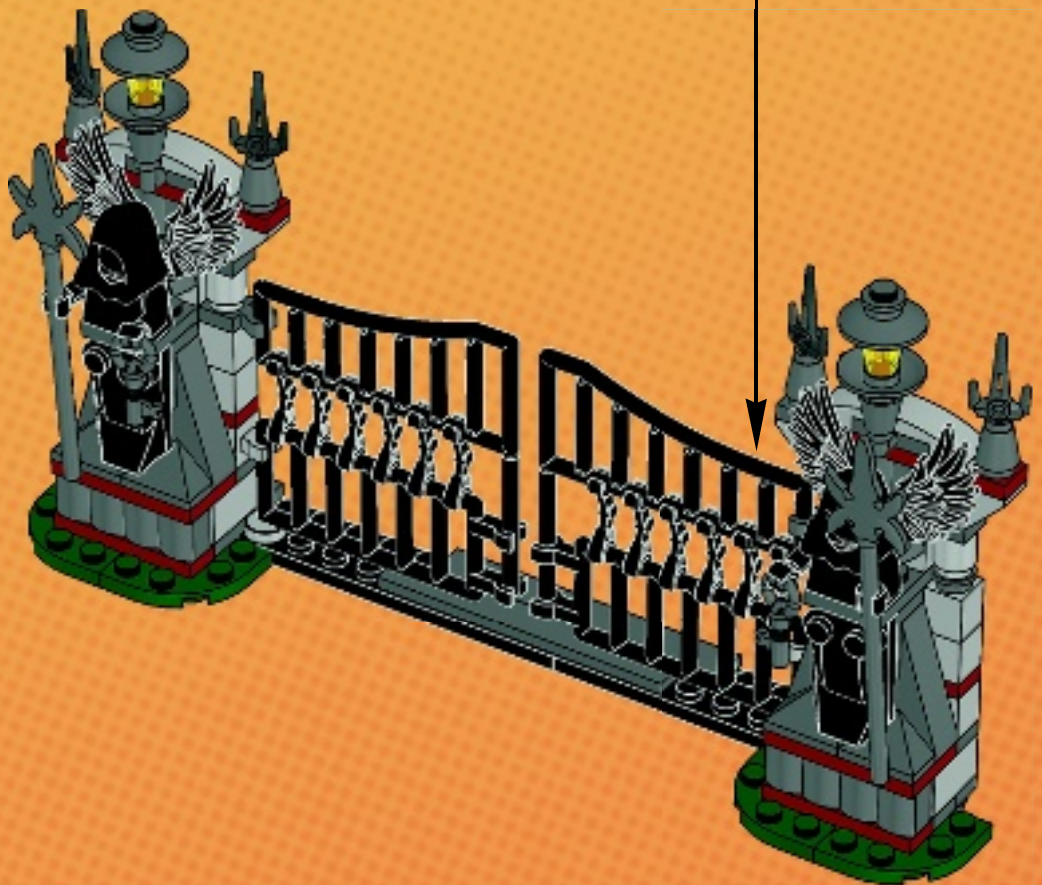
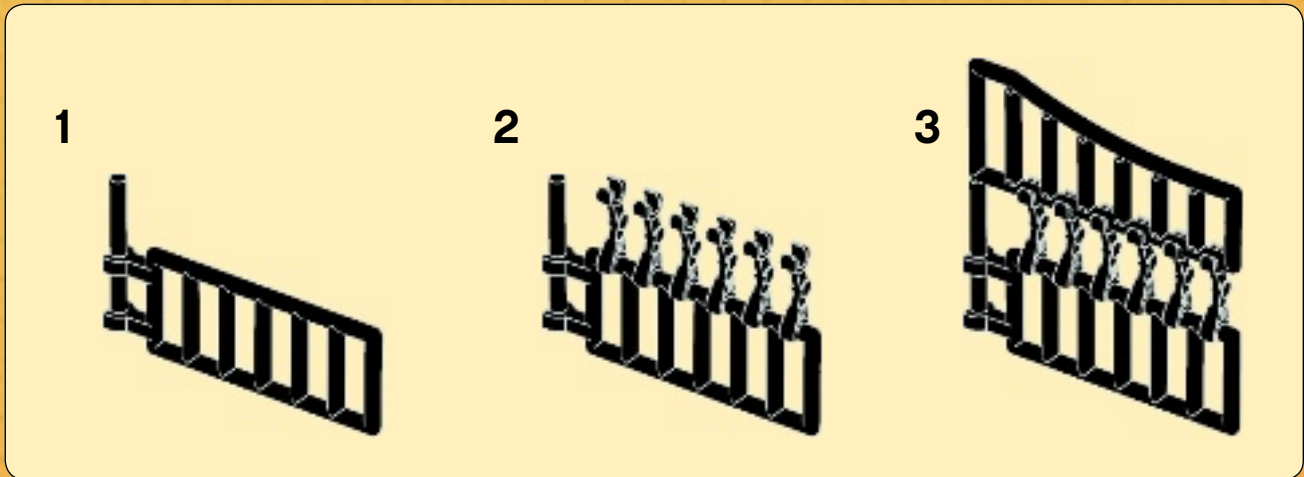



29

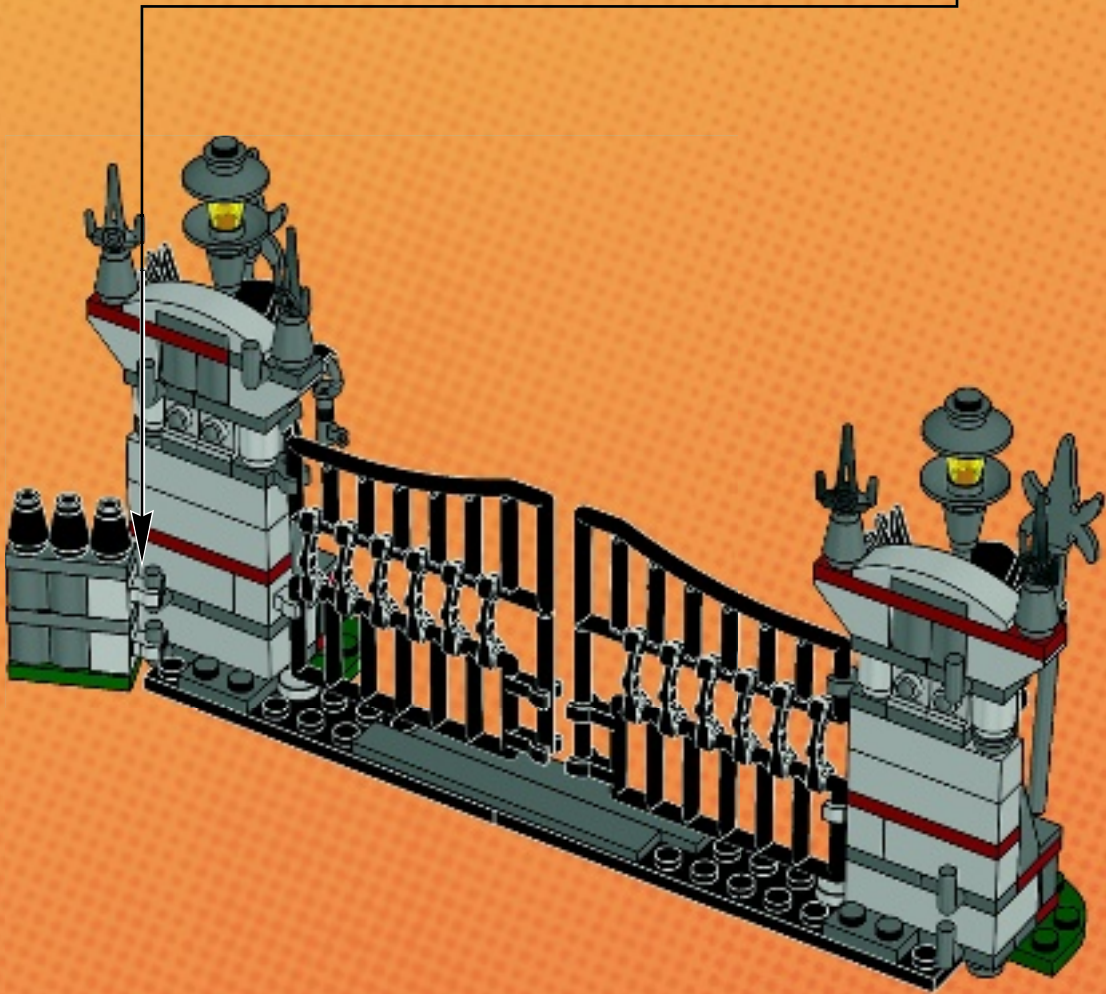
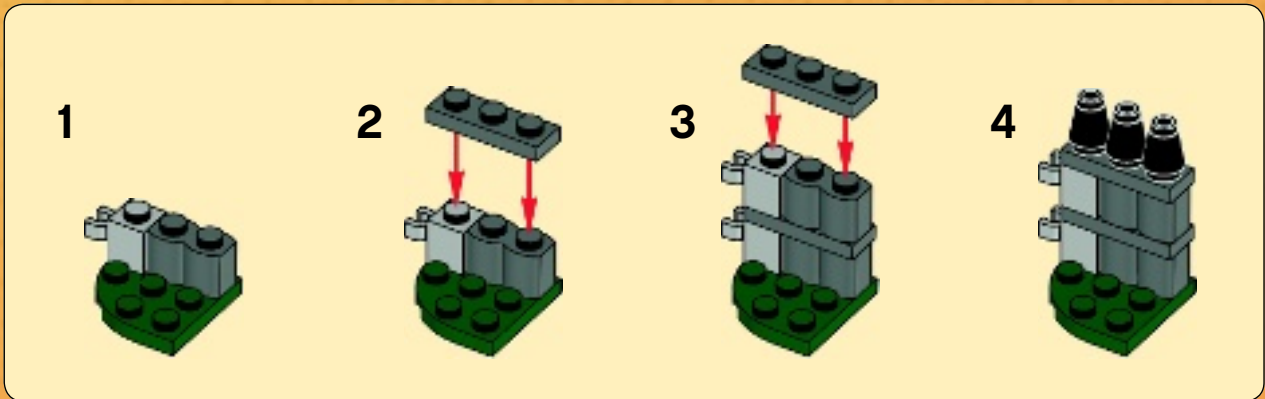

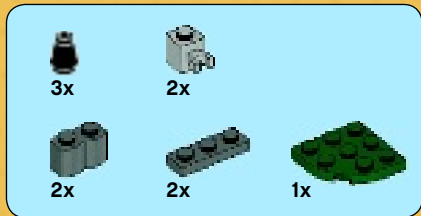

30

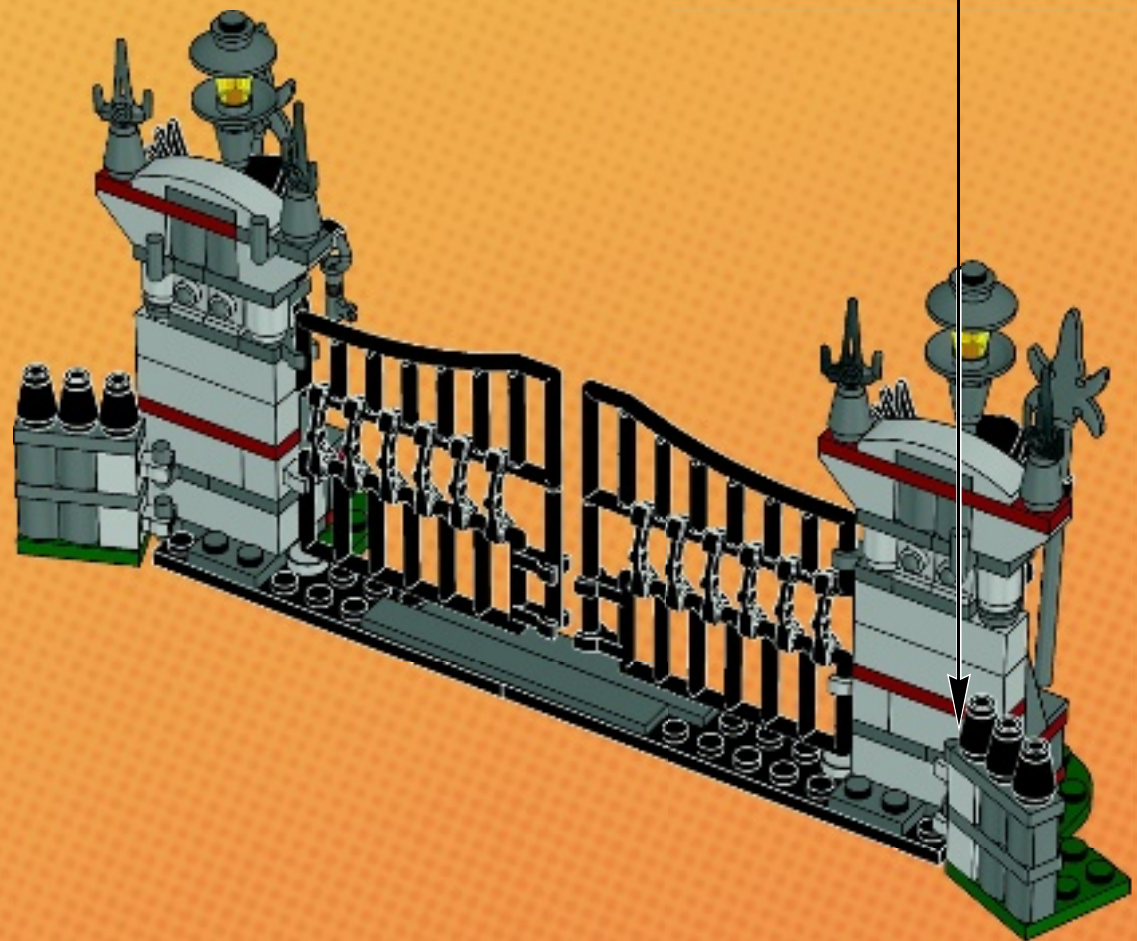
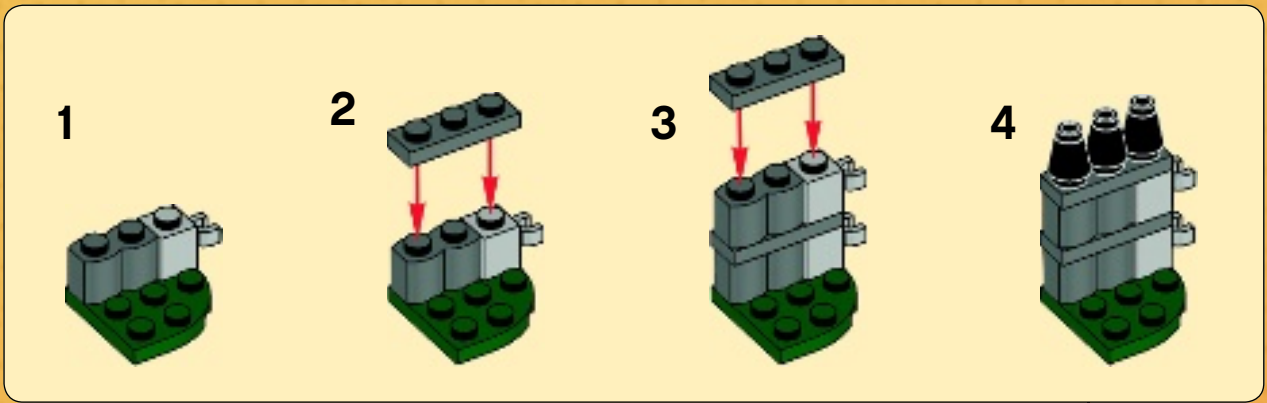



31

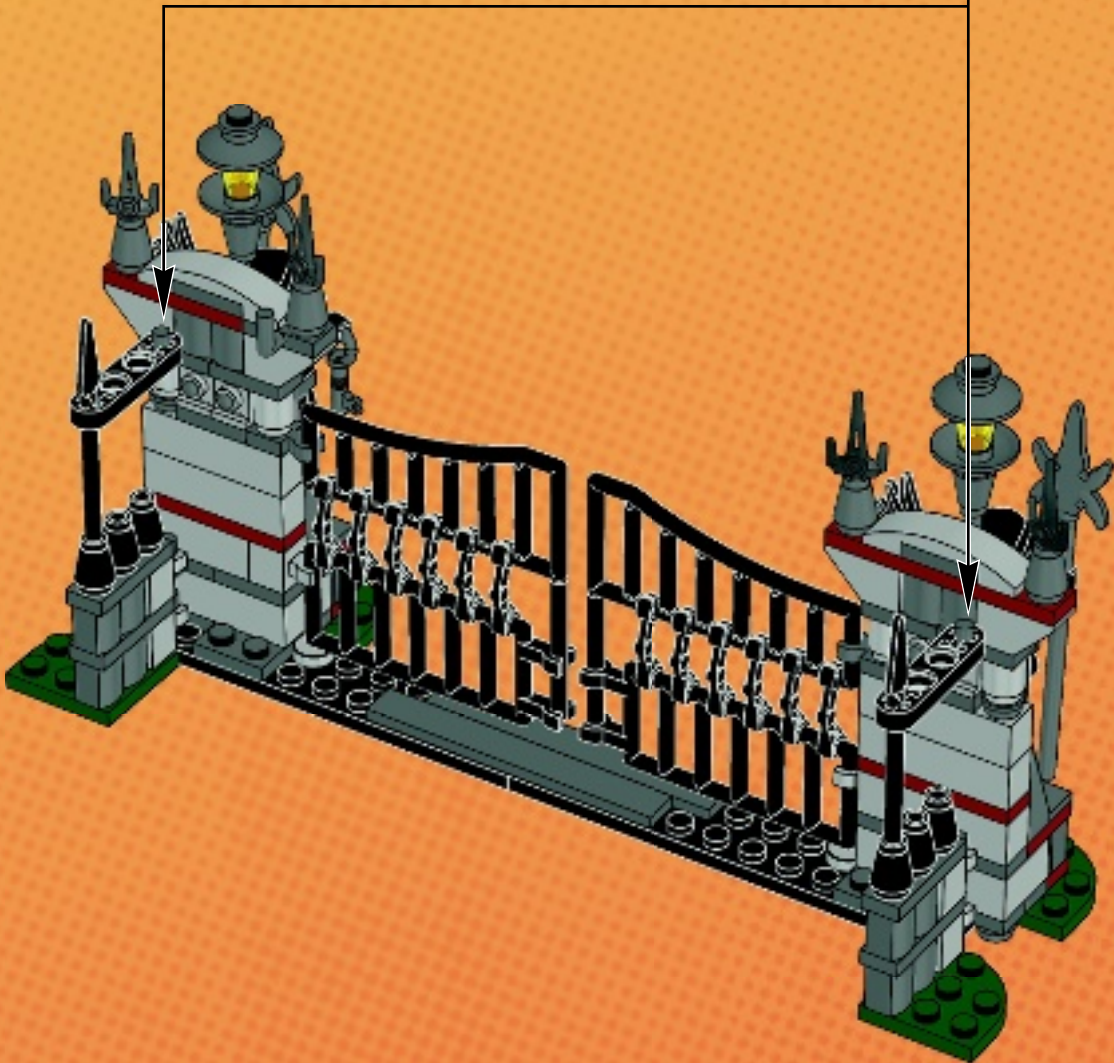



4x

32





33

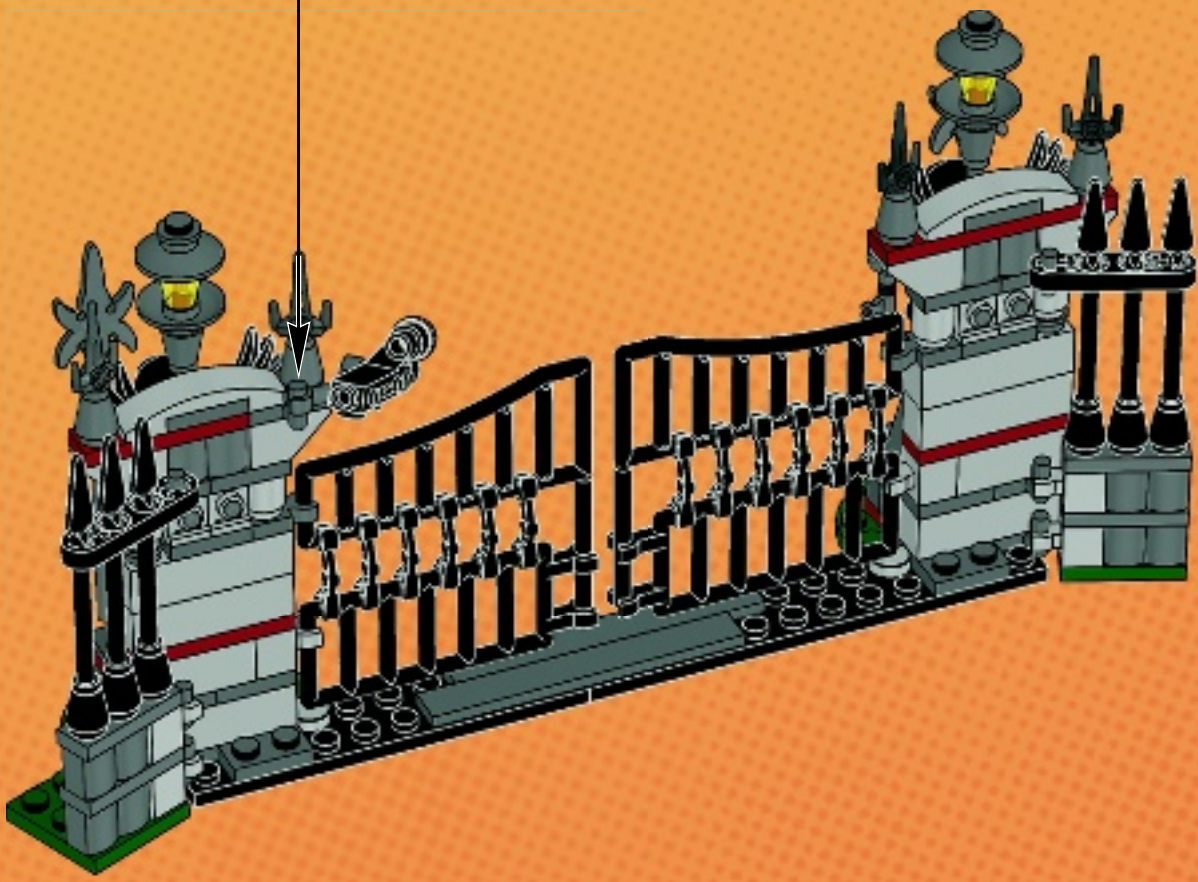
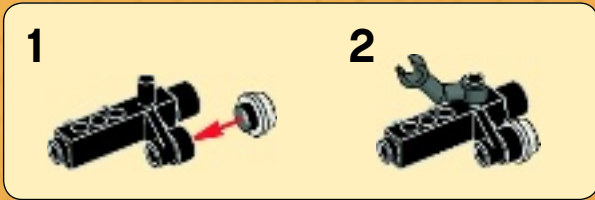

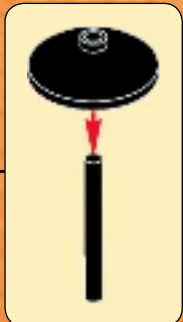
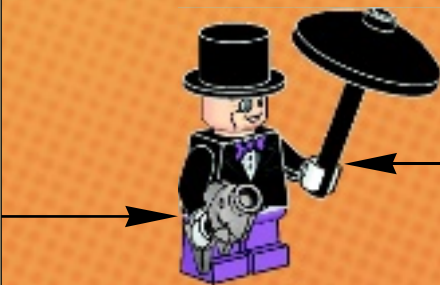
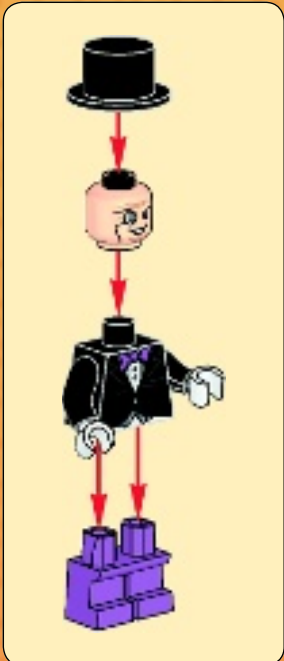
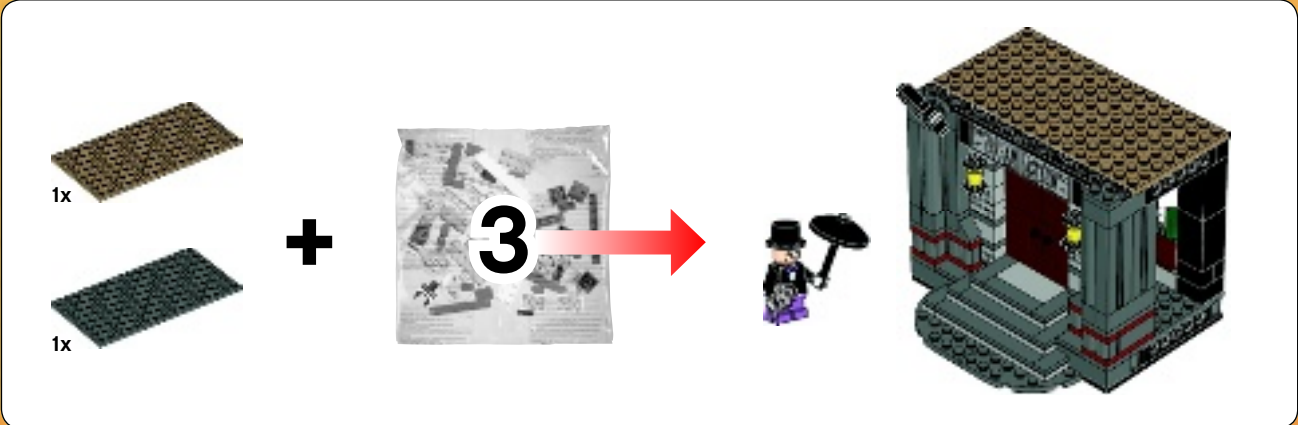



1

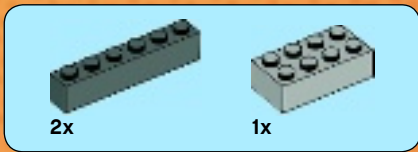
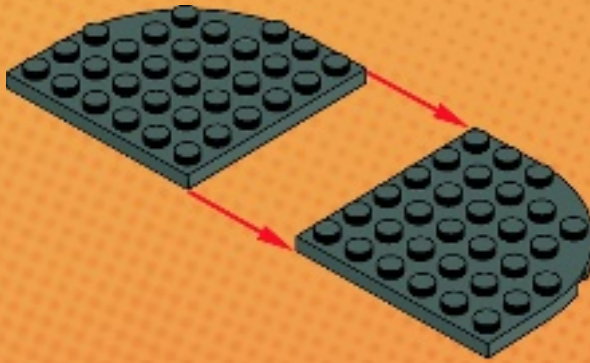

2

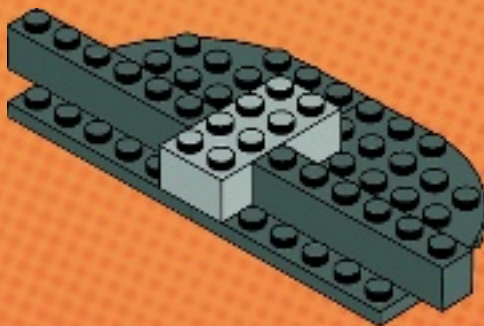



3

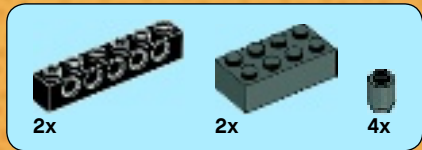
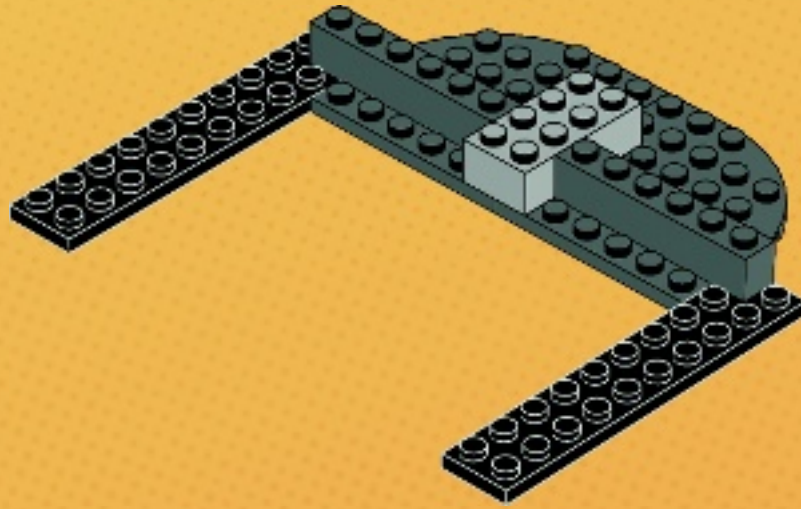

4

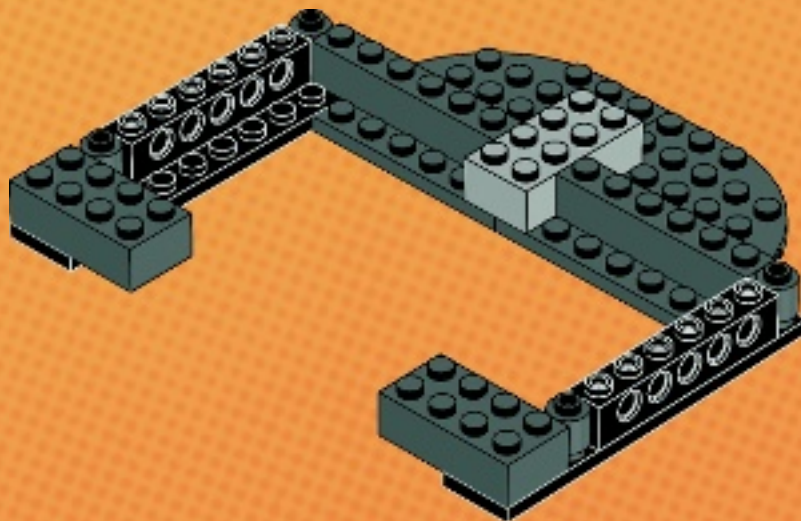



5

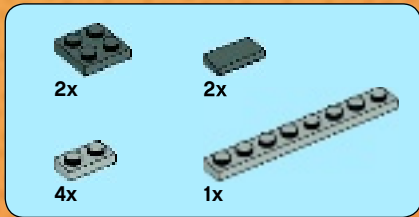
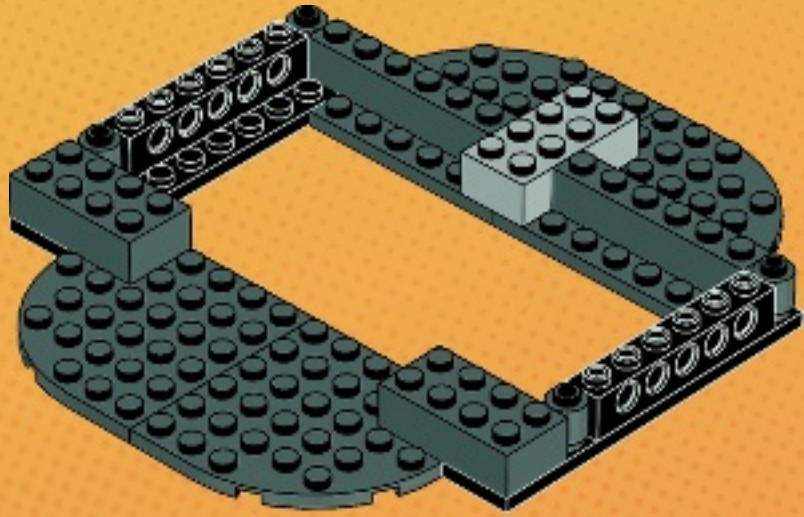

6

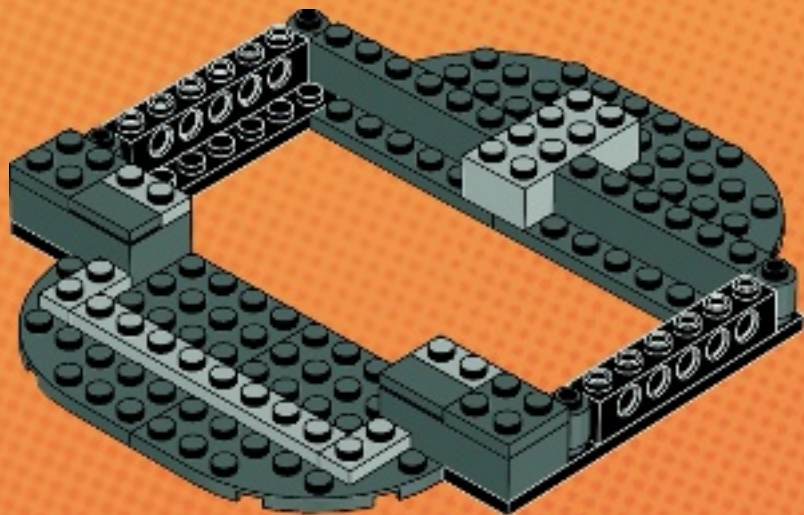

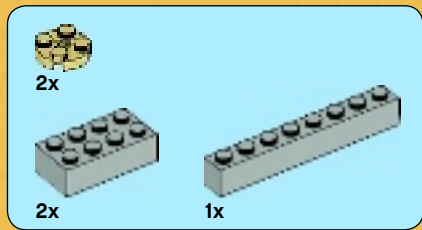

7

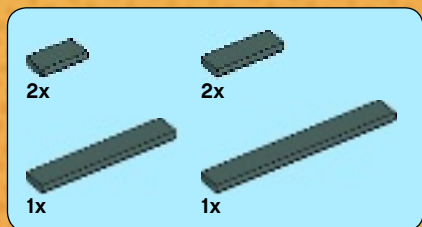
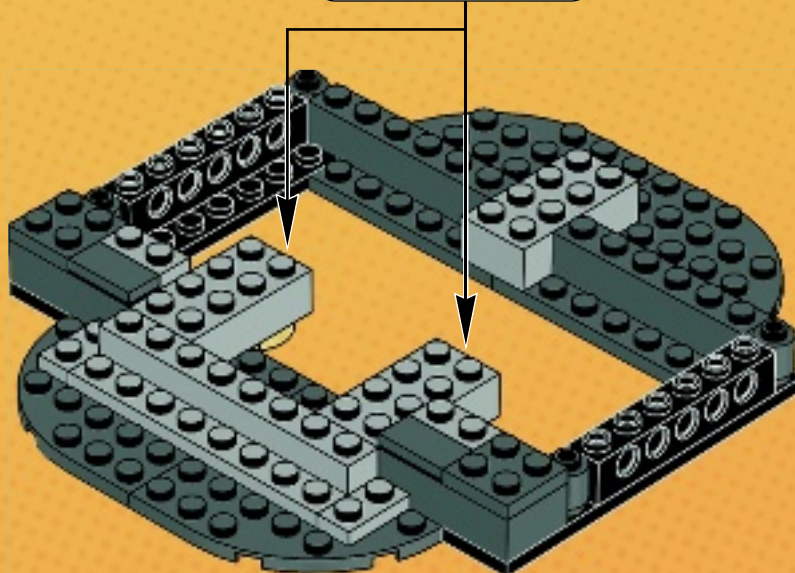
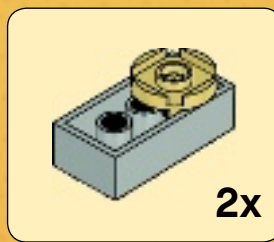

8

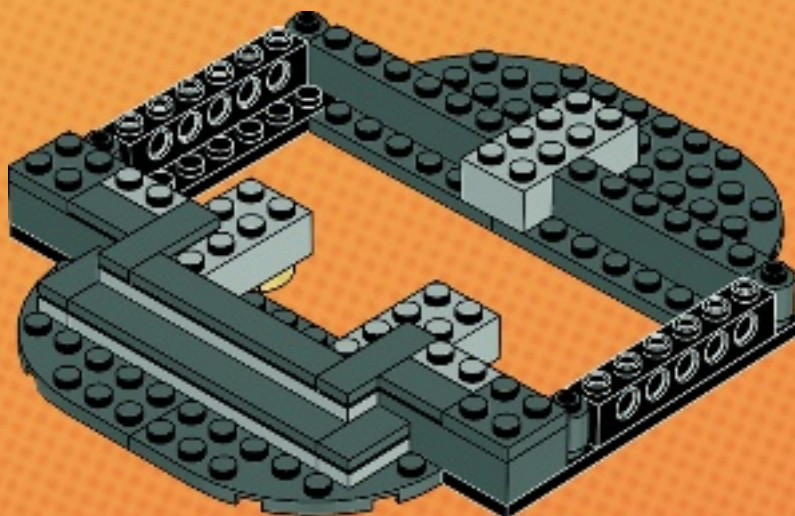

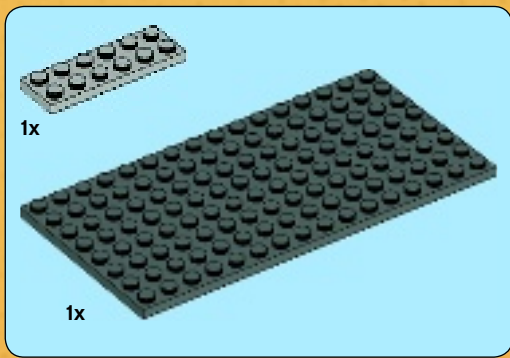

9

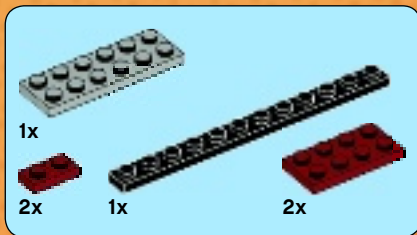
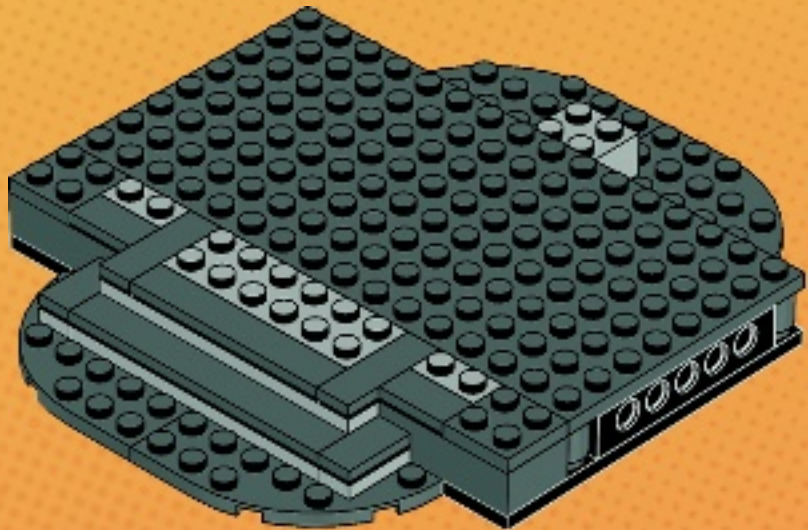

10

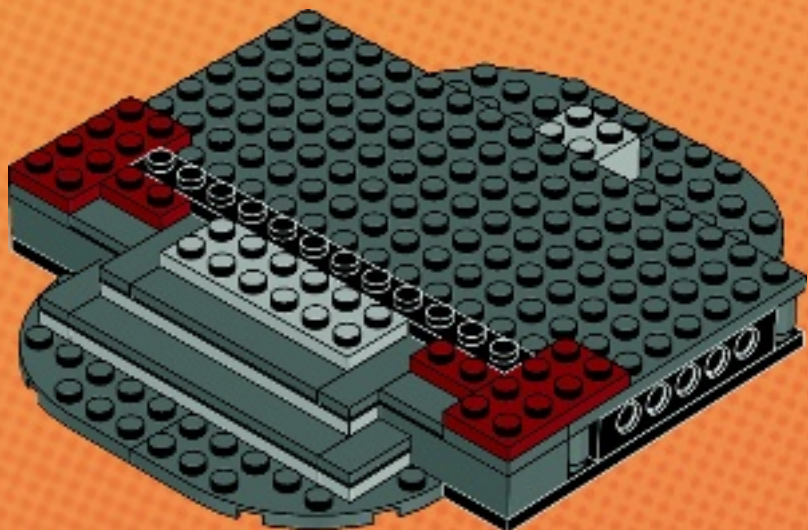

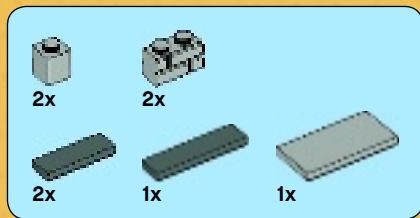

11

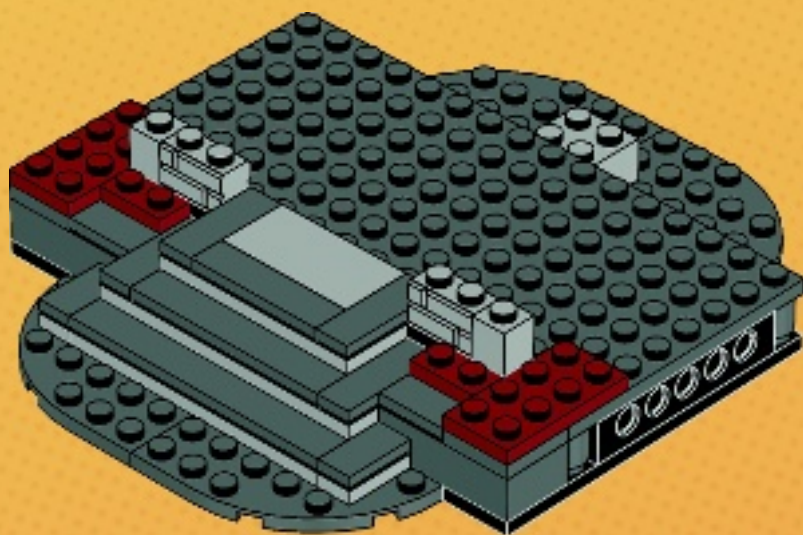

12

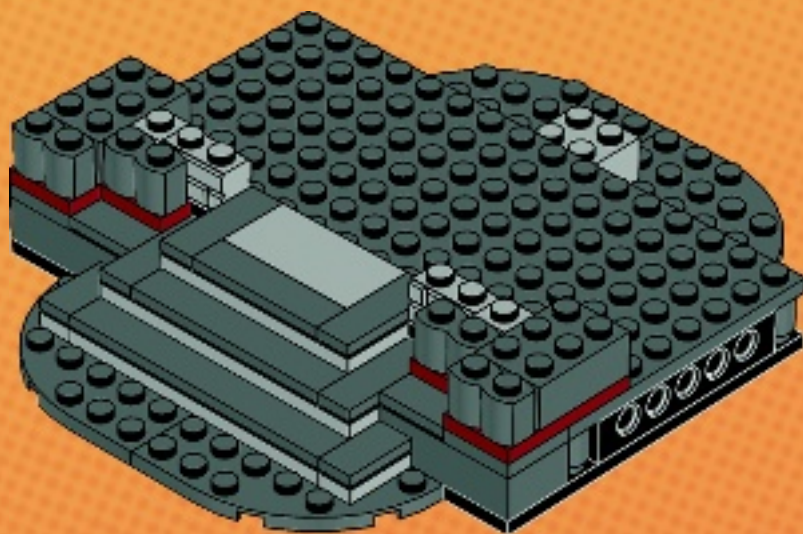



13

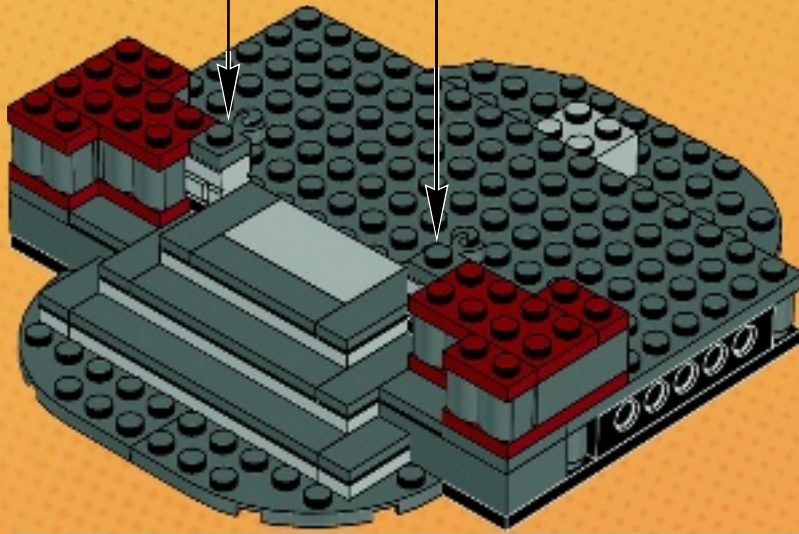

14

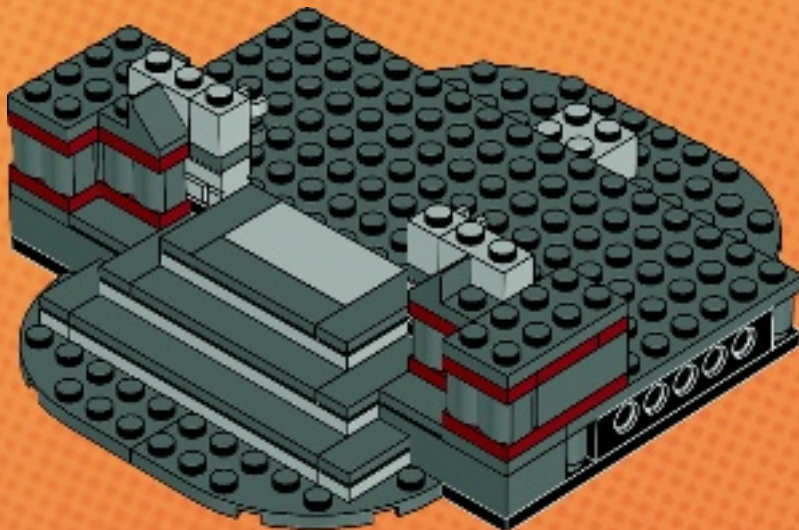



15

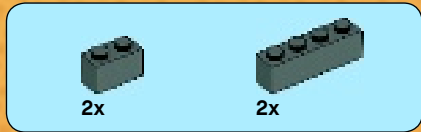
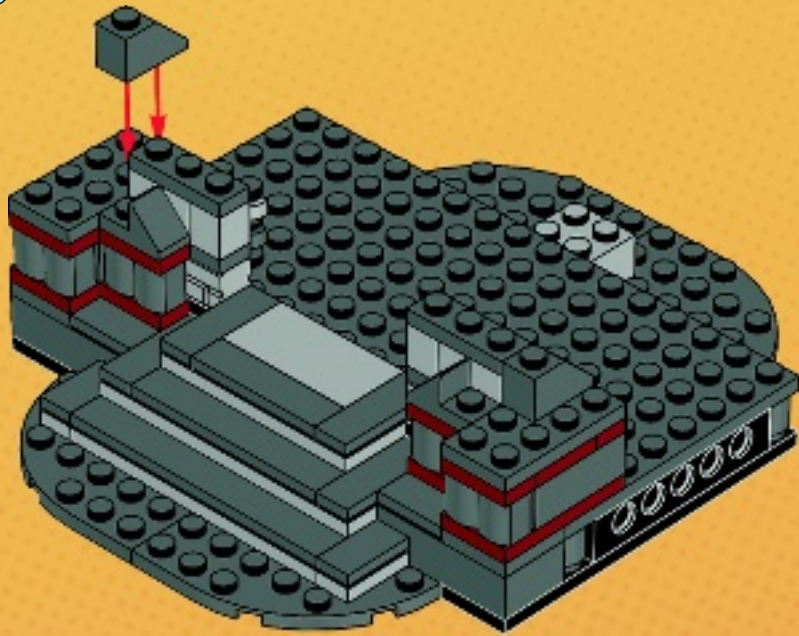

16

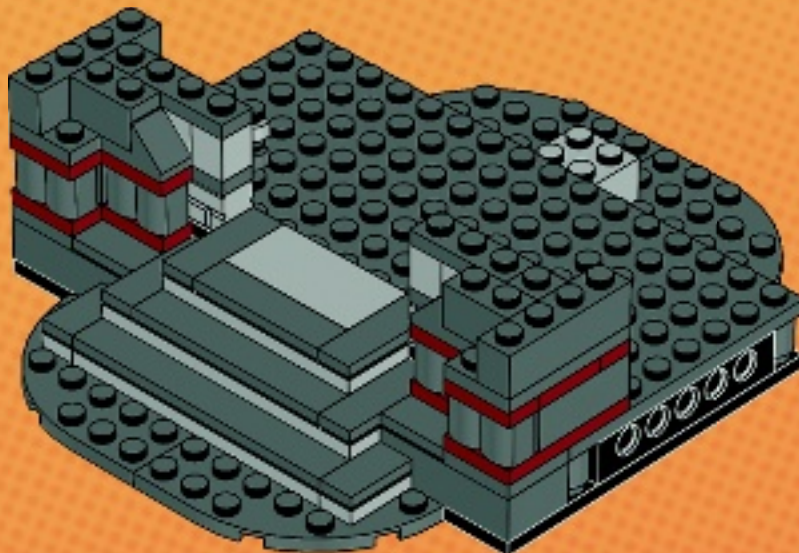

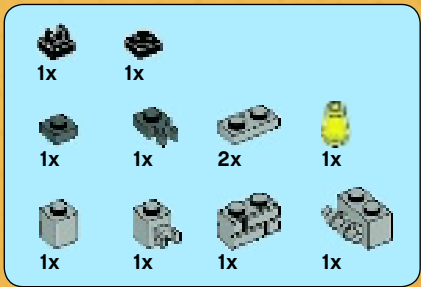

17

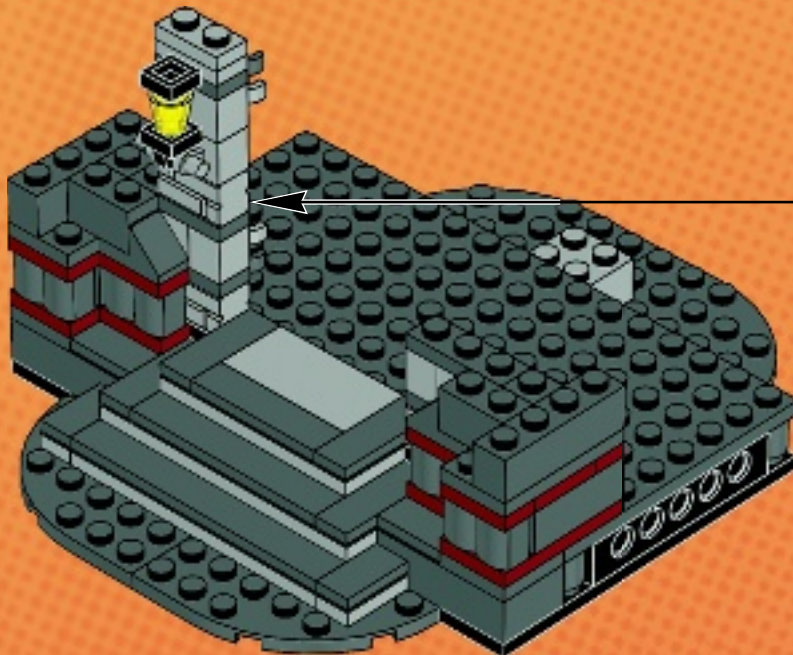
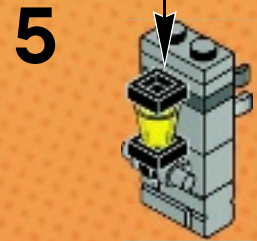
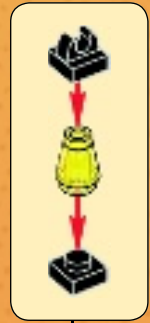
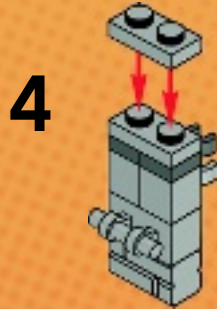
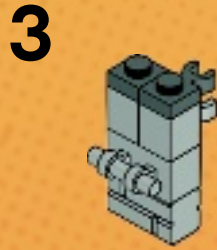
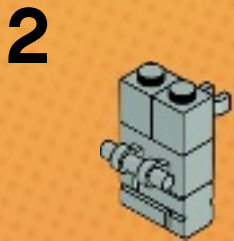
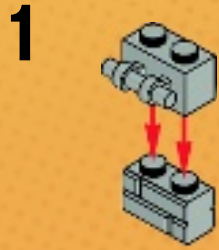

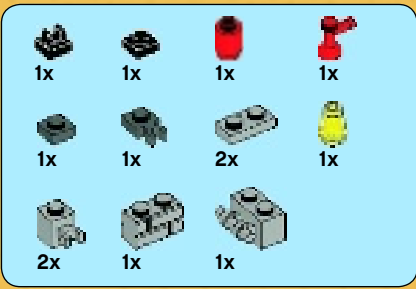

18

1

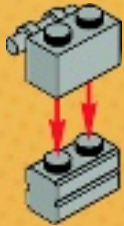

2



3

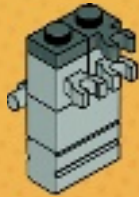

4

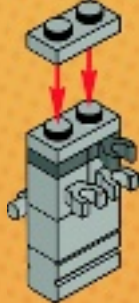

5



6

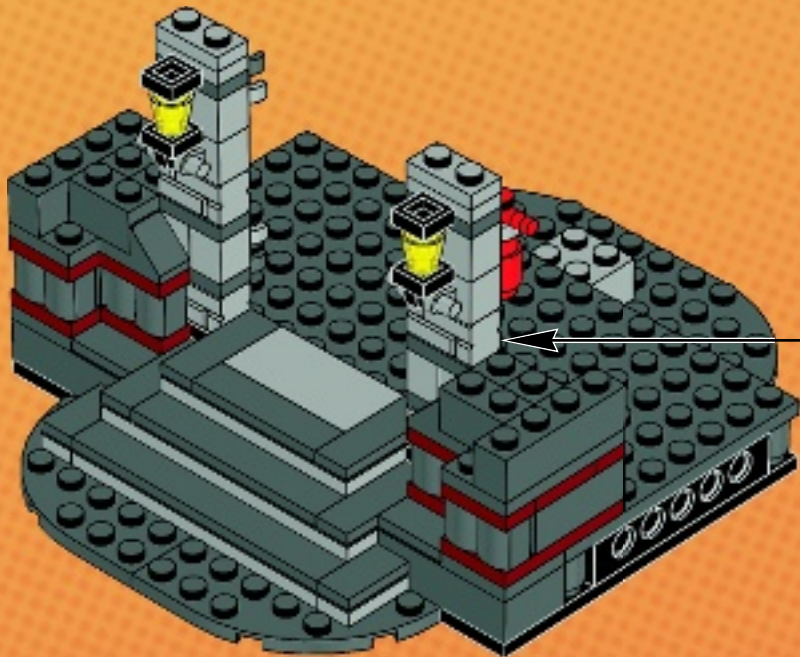
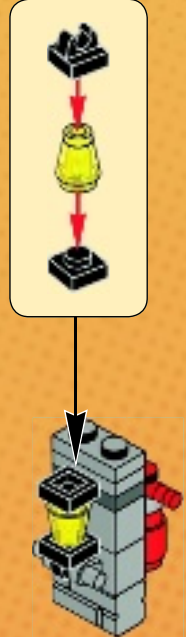

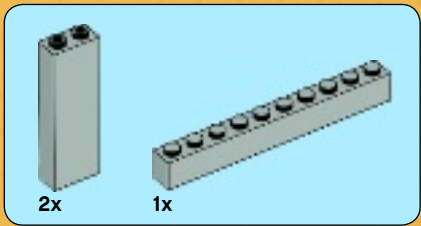

19

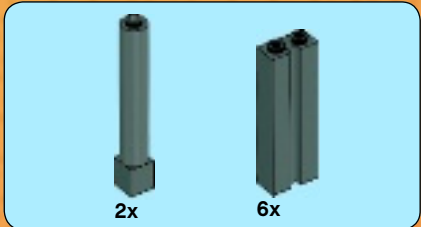
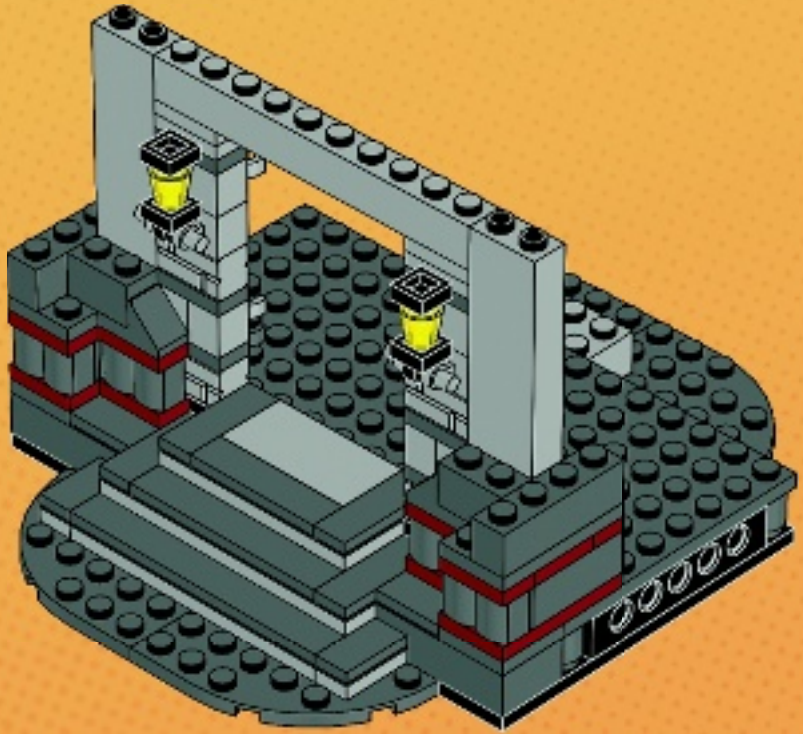

20

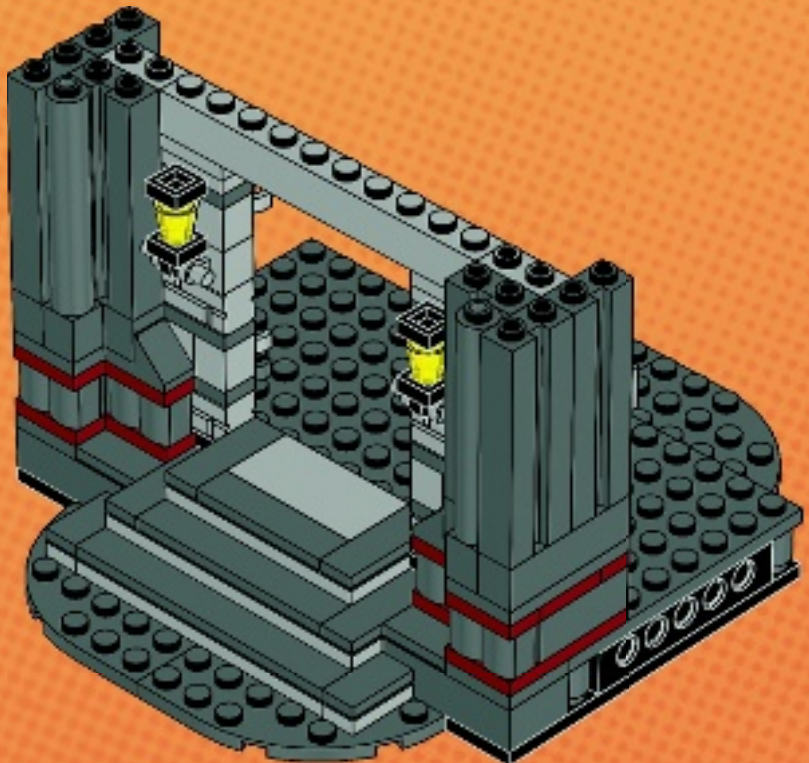



21

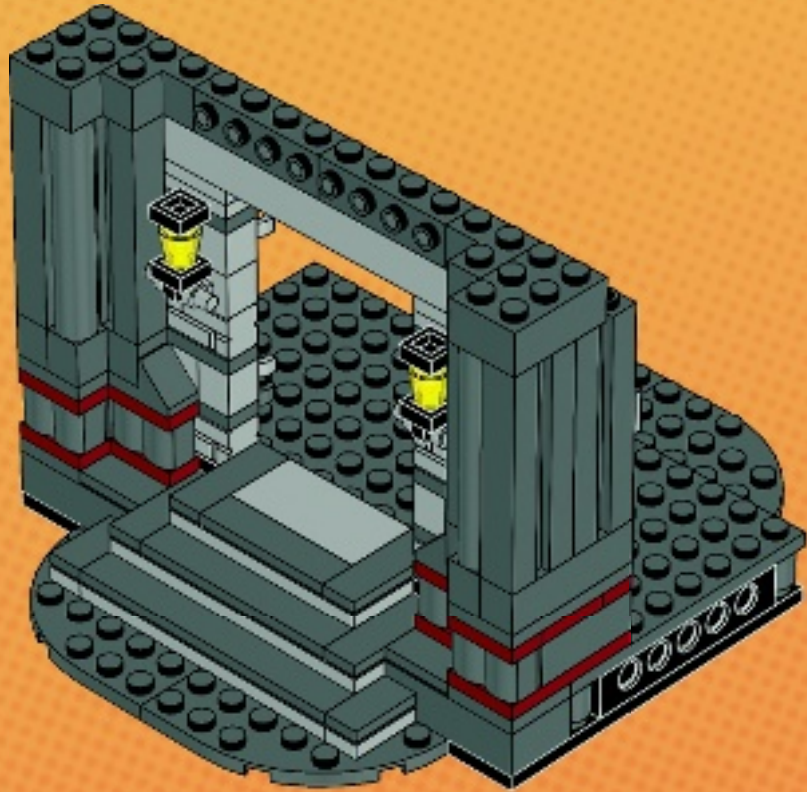

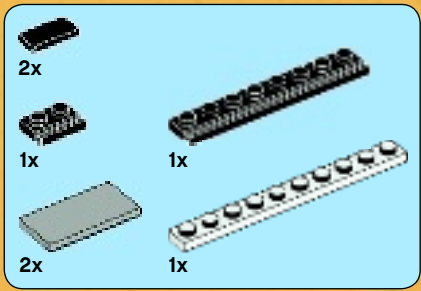

22

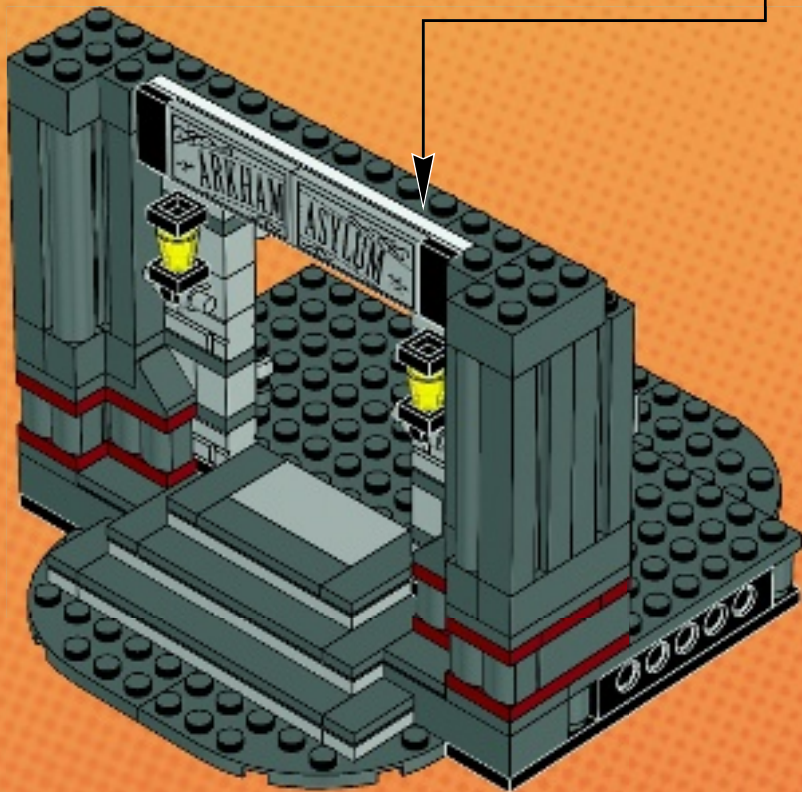
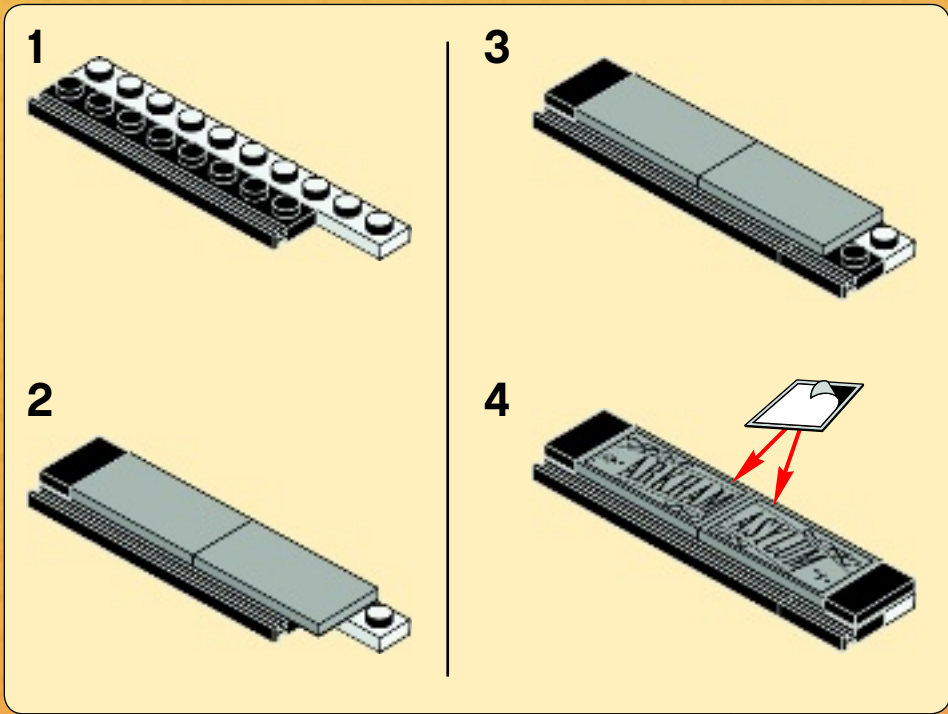

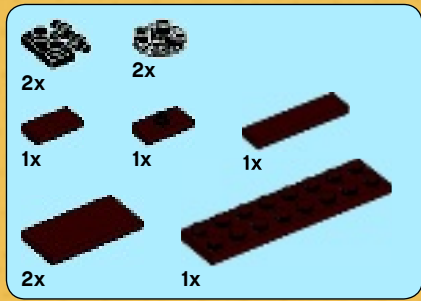

23



1

2

3

4

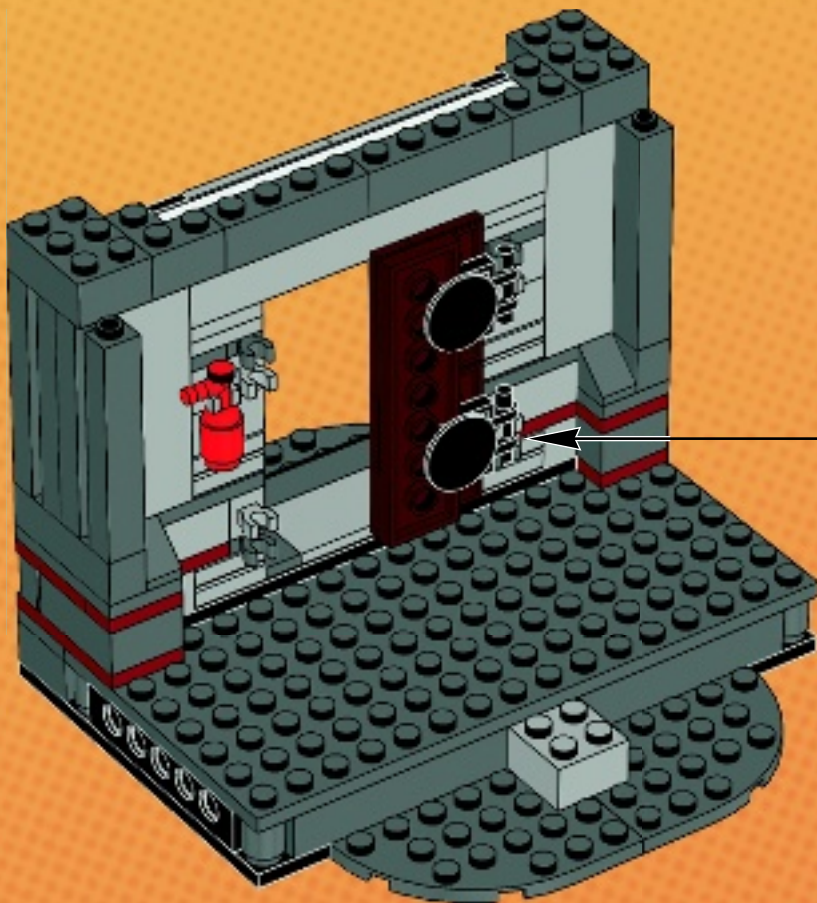

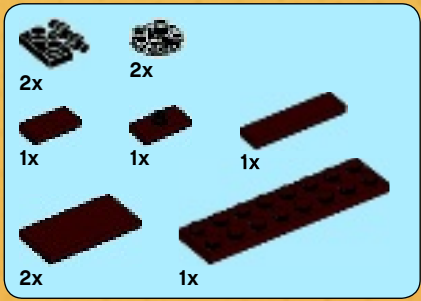

24

Four-step assembly diagram for step 24:

1. A 1x5x1 dark red Technic brick is shown.
2. A 1x3x1 dark red Technic brick is attached to the top of the 1x5x1 brick.
3. Two 1x2x1 dark red Technic bricks are attached to the top of the 1x3x1 brick. A circular arrow icon indicates that the assembly is symmetrical.
4. Two 1x1x1 dark red Technic bricks are attached to the top of the 1x2x1 bricks.

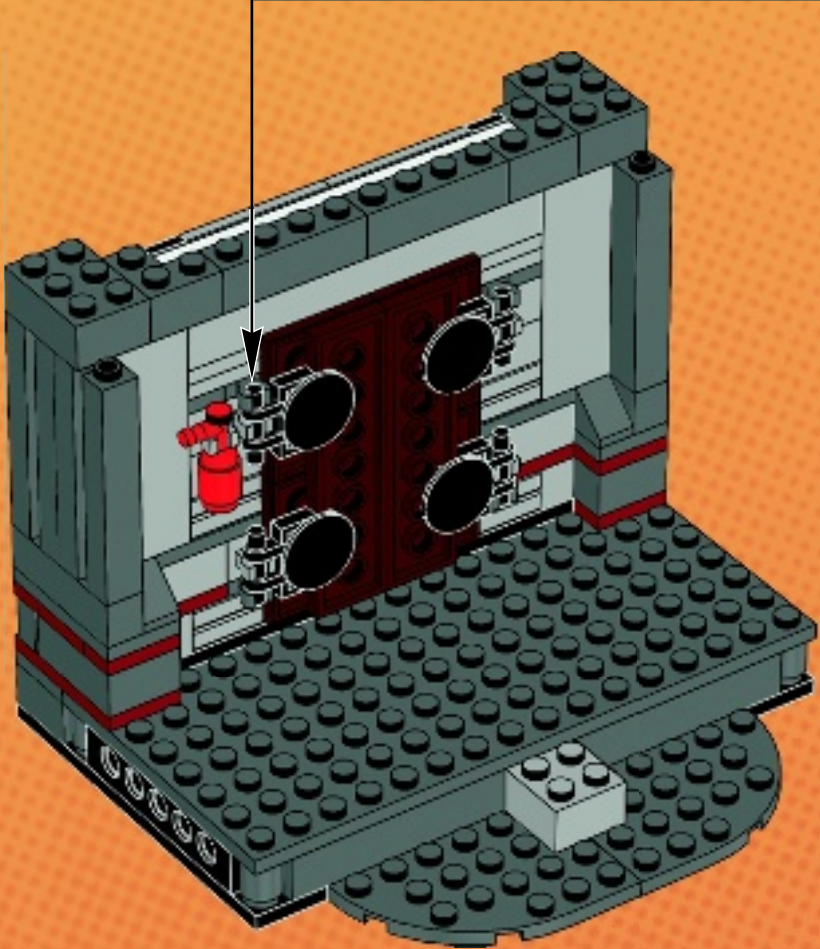

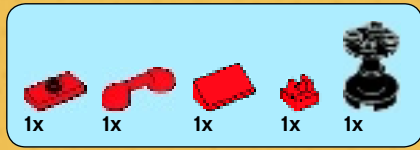

25

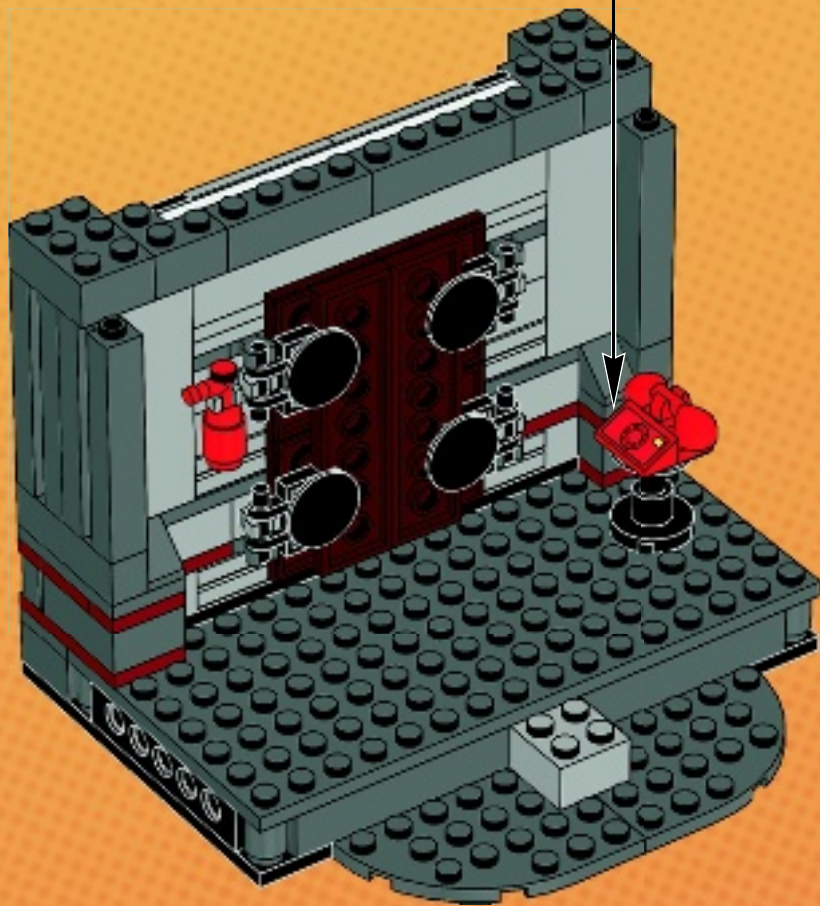
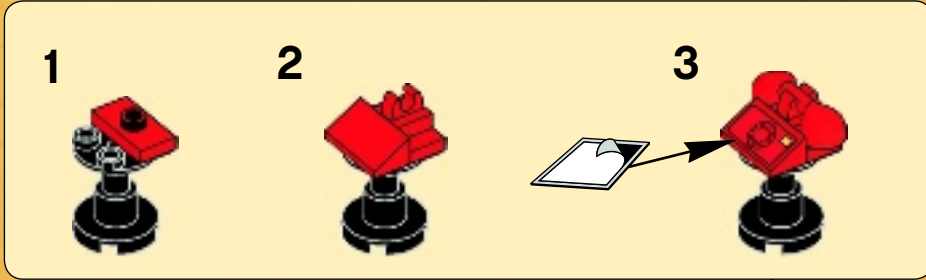

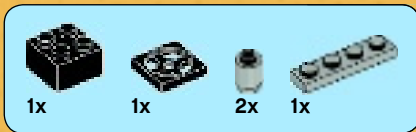

26

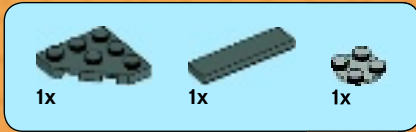
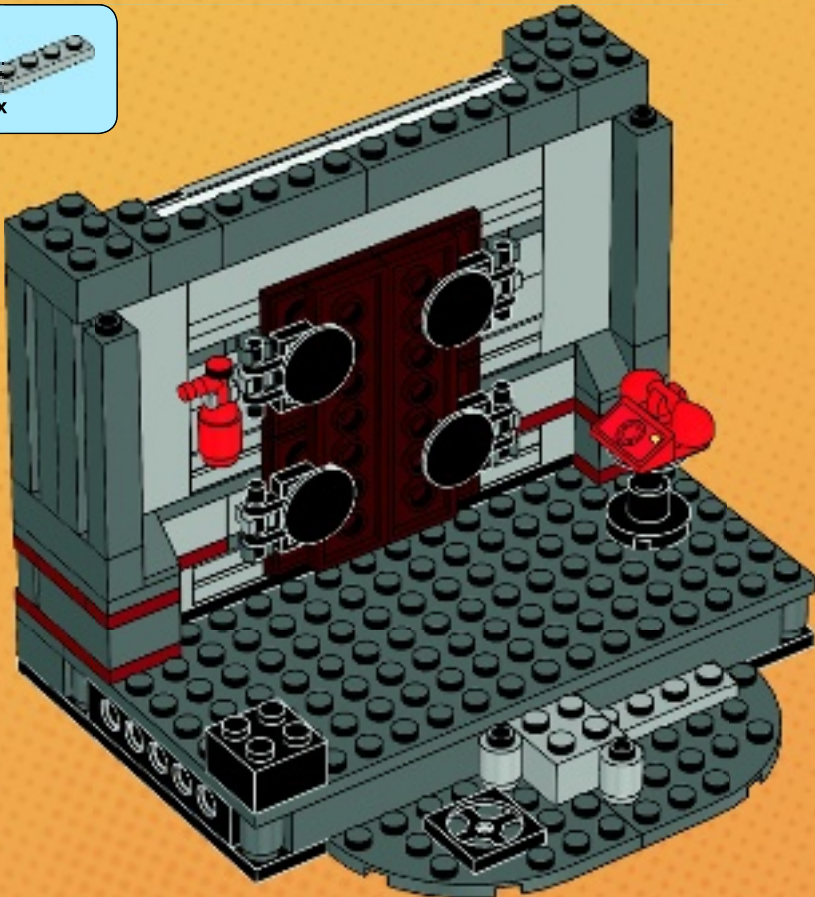

27

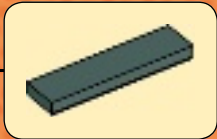
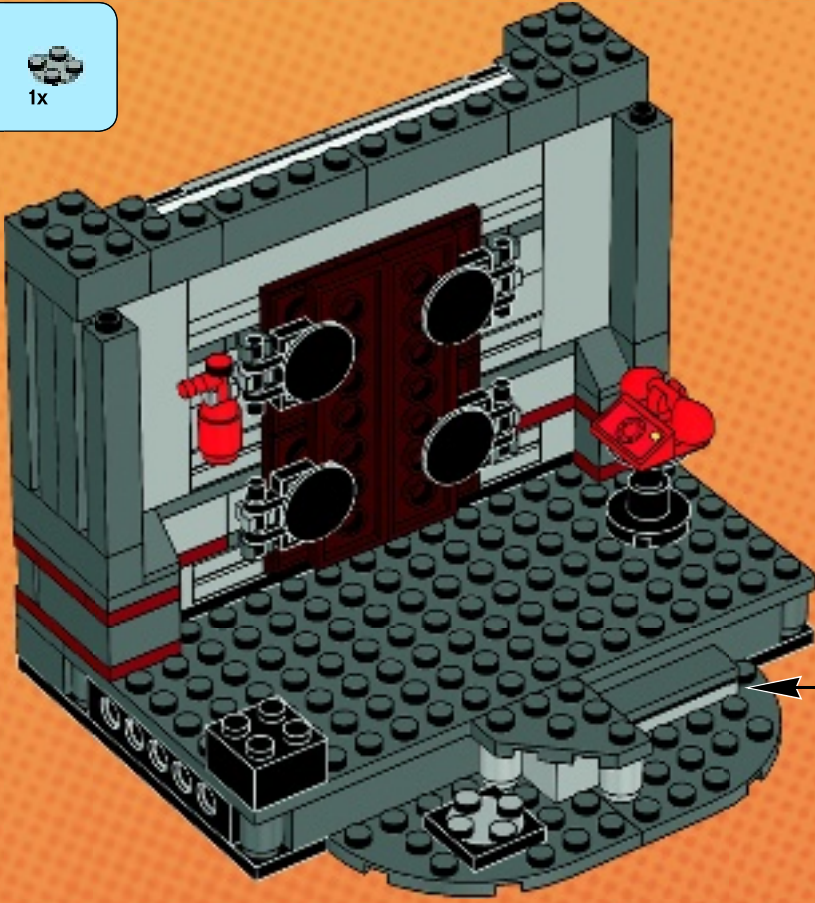



28

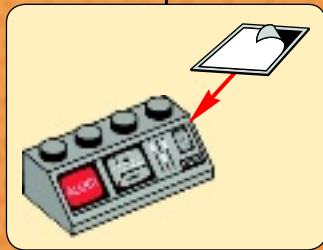
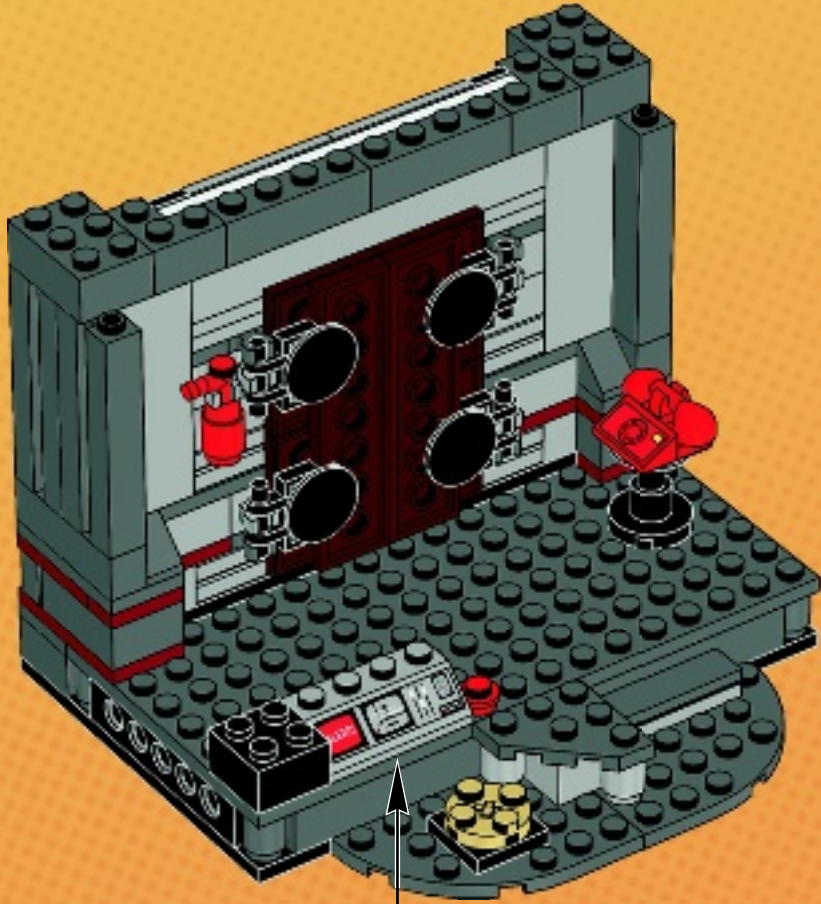

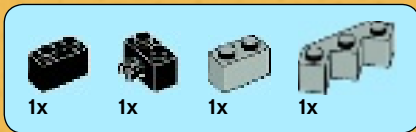

29

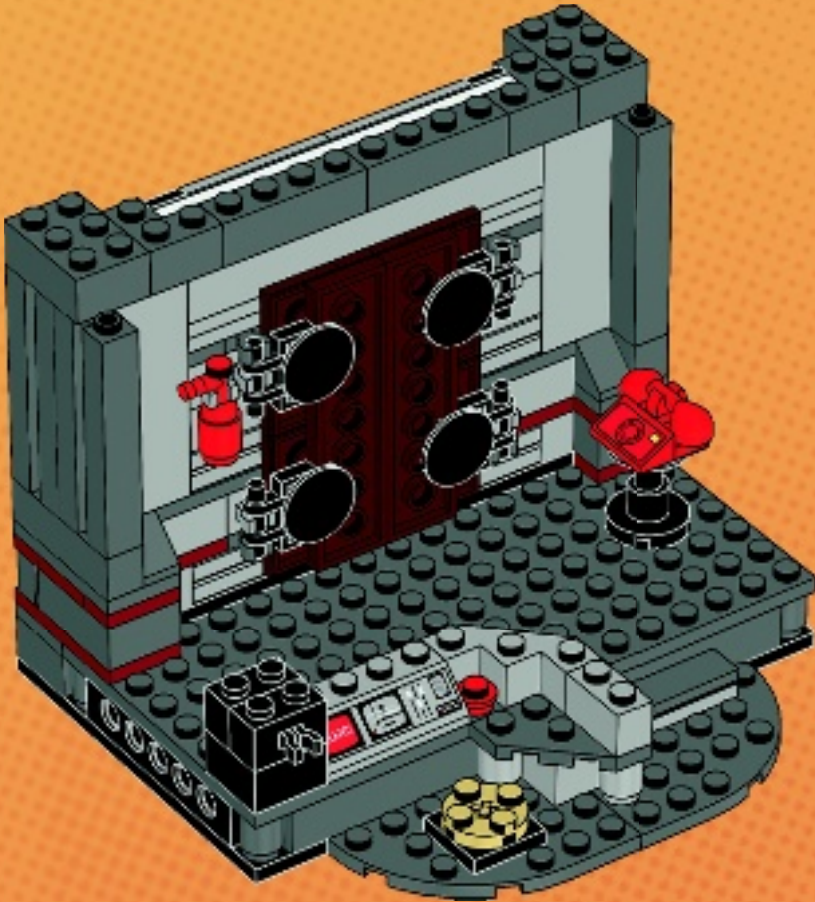

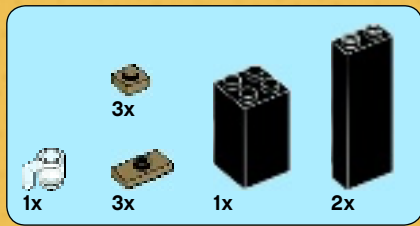

30

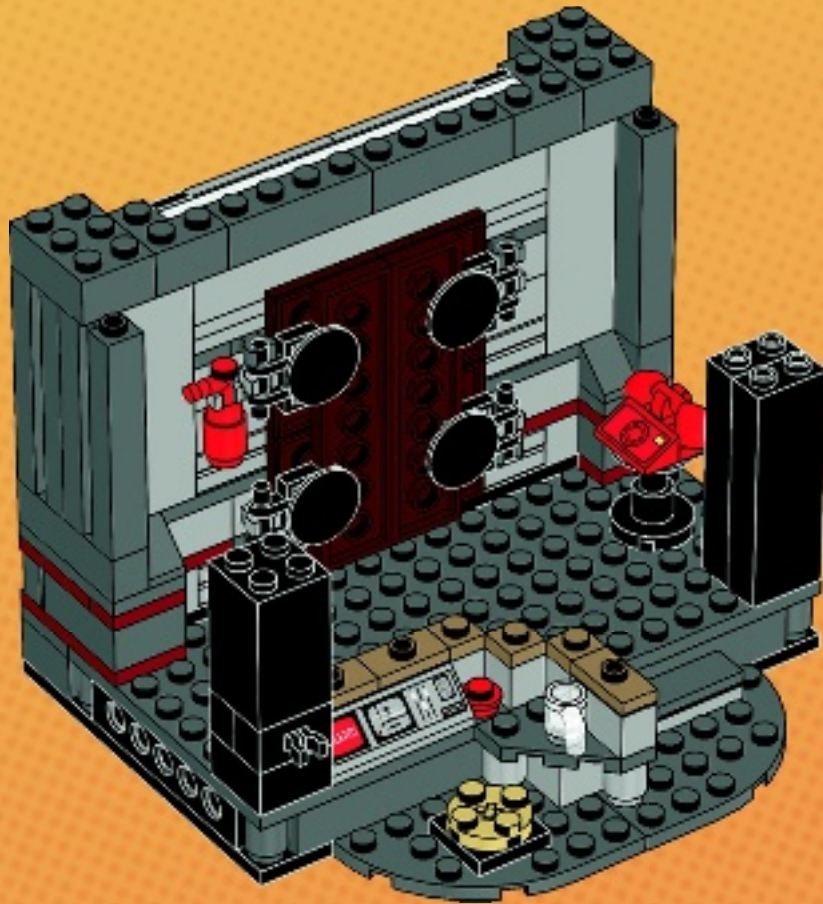



31

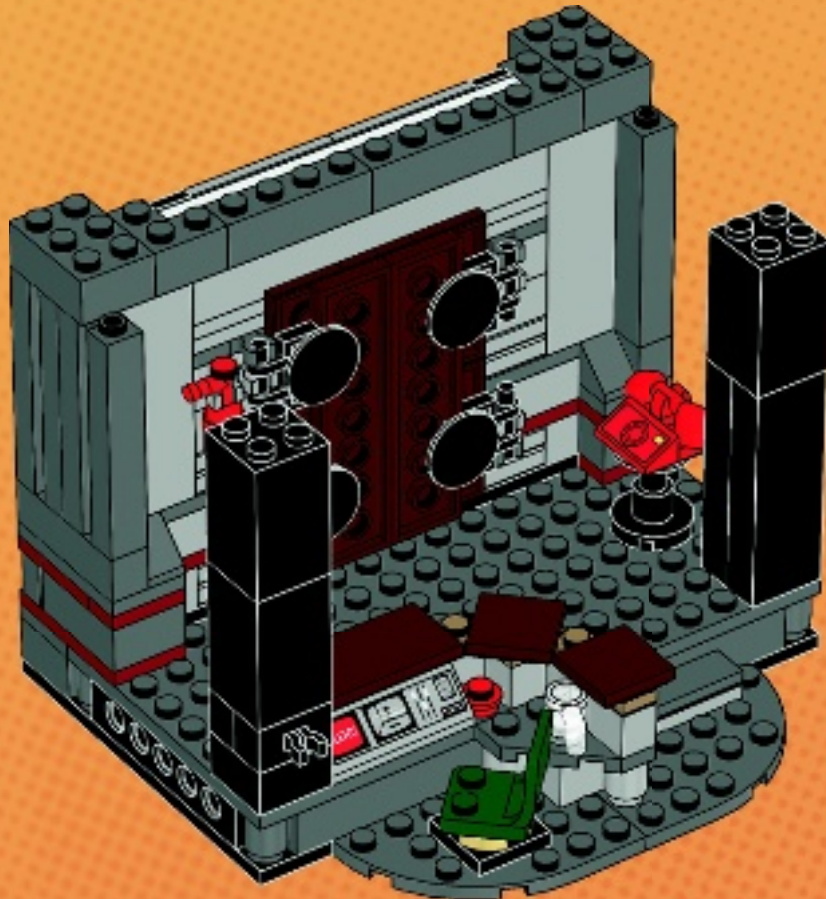

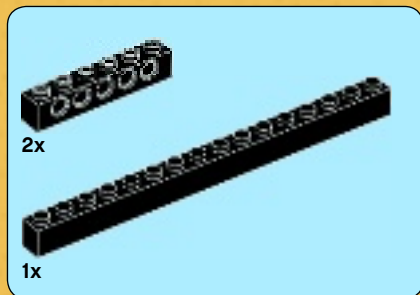

32

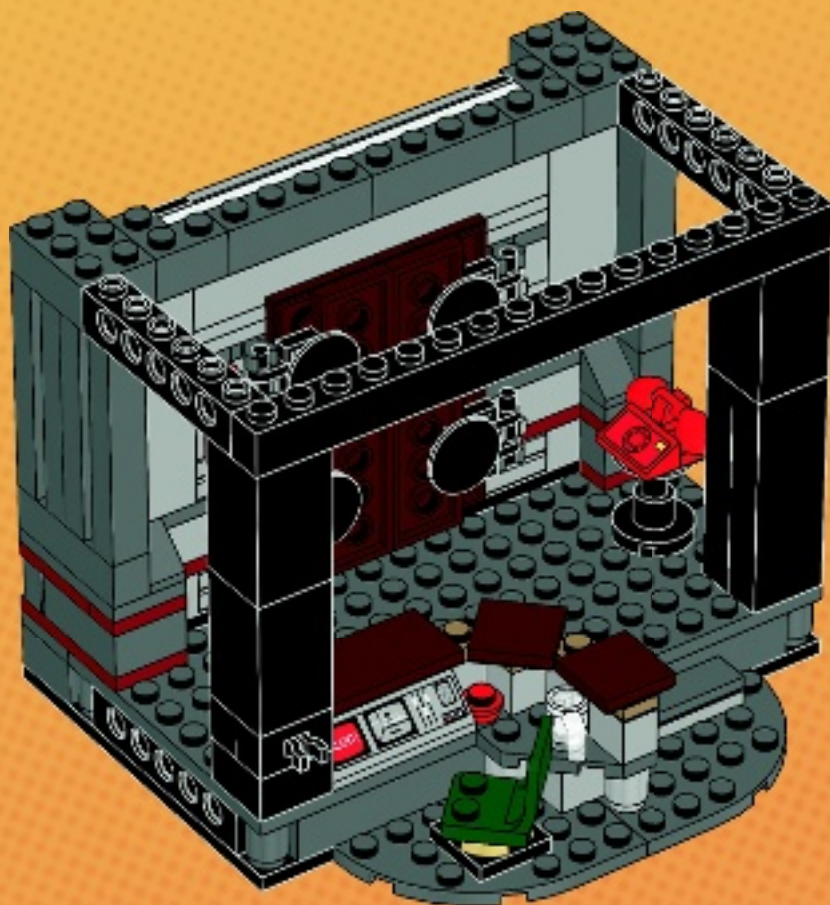

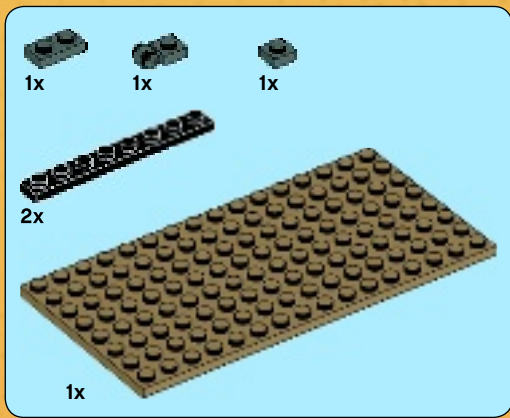

33

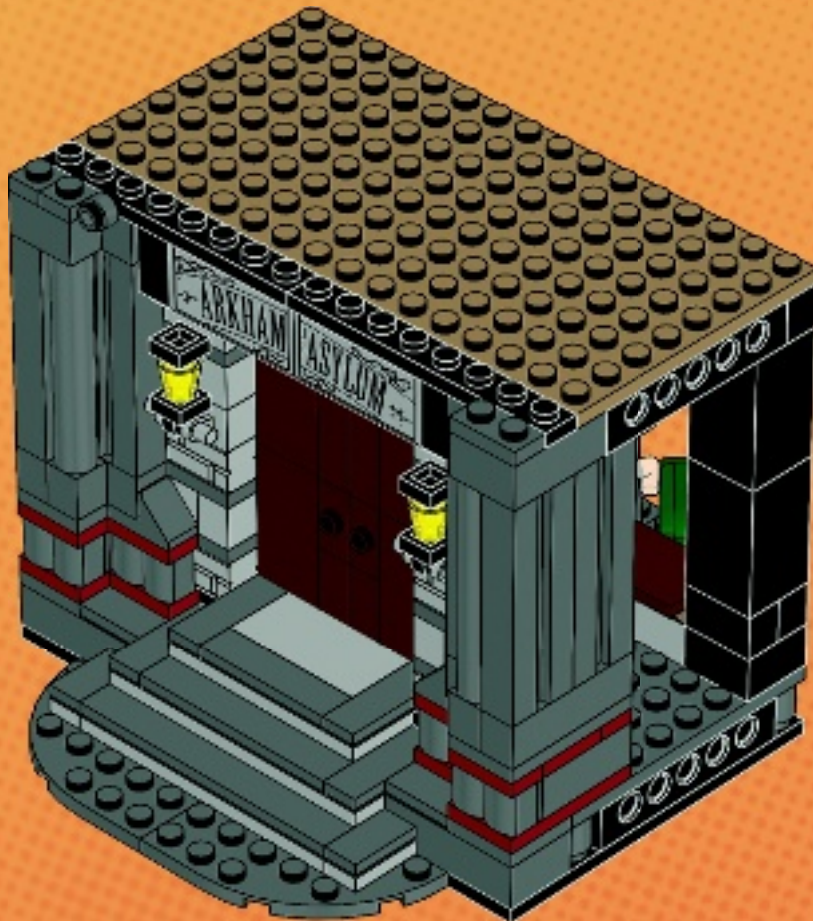



34

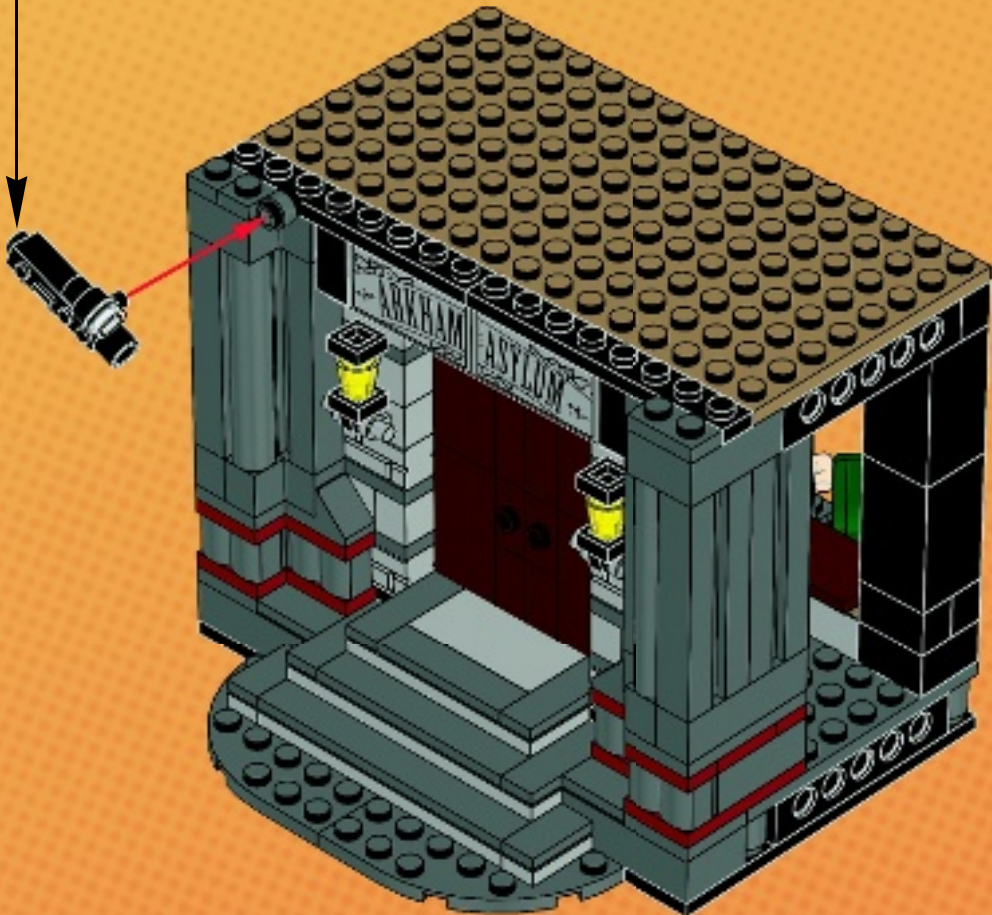
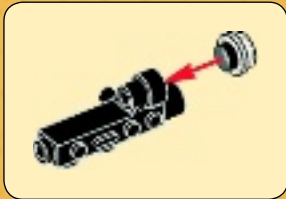



4



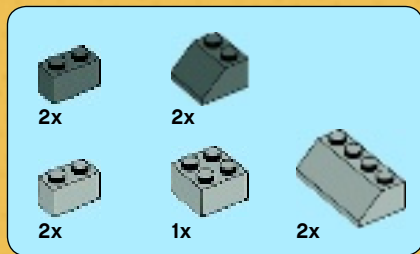

35



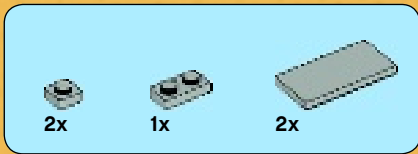

36





4x

37





2x



2x

38





2x

1



2x



1x

2



2x



1x

3



2x



1x

4



1x

5



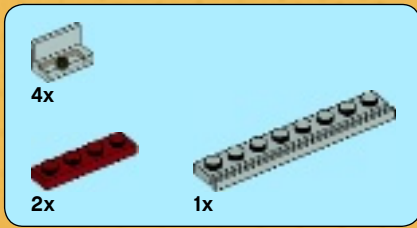

6

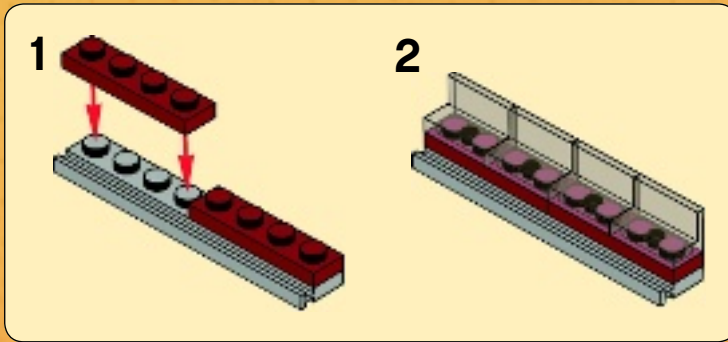

39

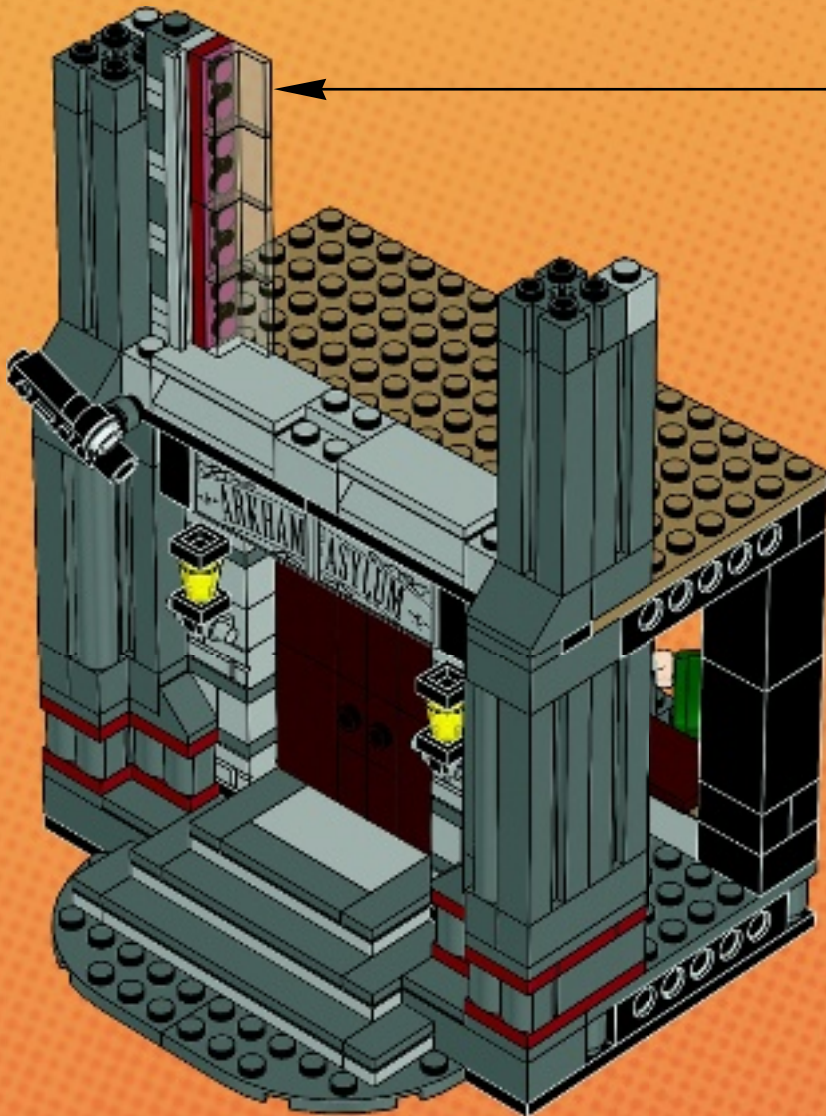

2x

1



2x

1x

2



2x

1x

3



2x

1x

4



1x

5



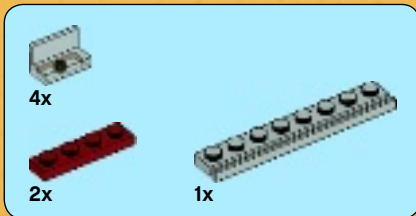

6

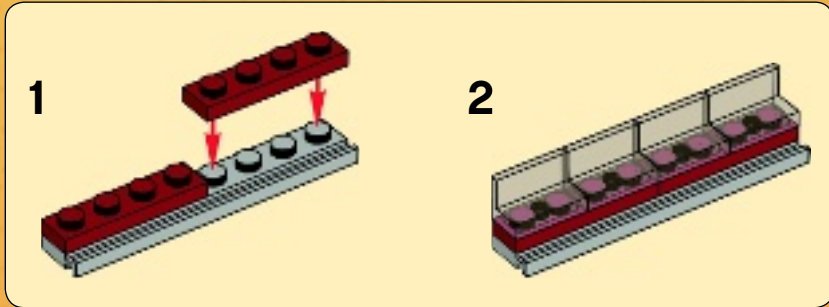

40

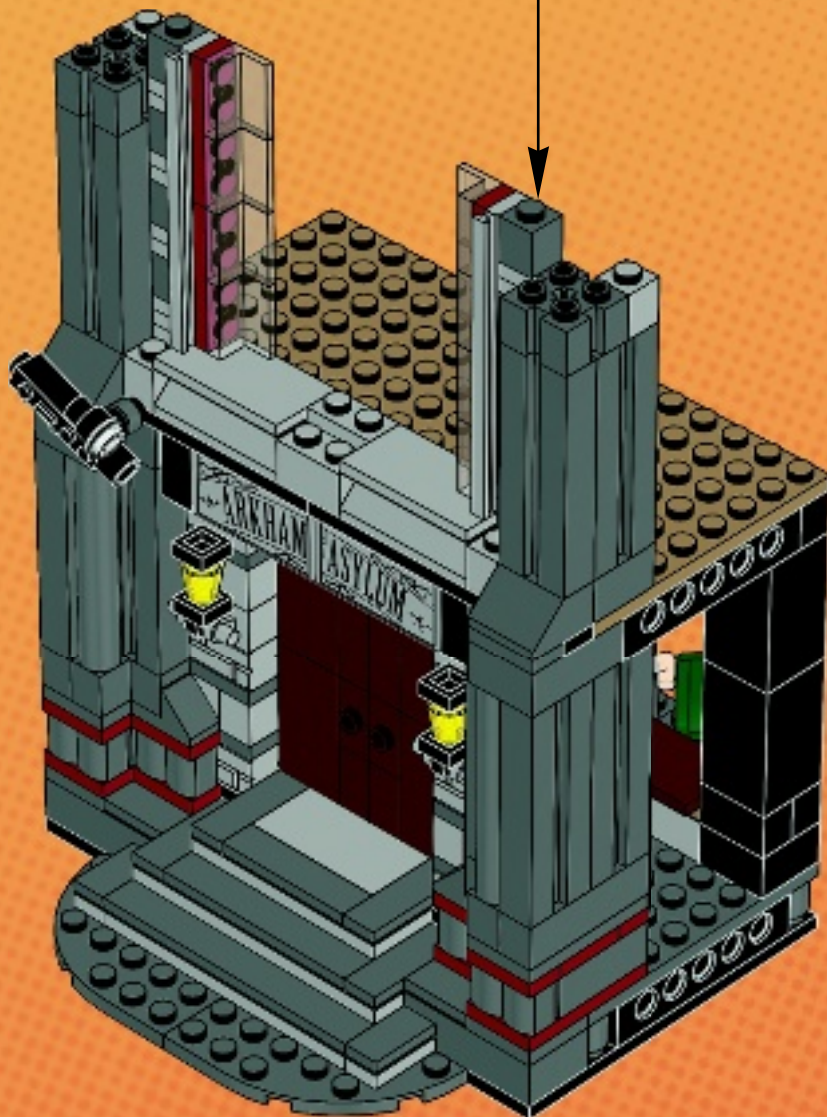



2x

1

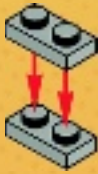

2x



2x

2



2x



2x

3



2x



2x

4



2x

5



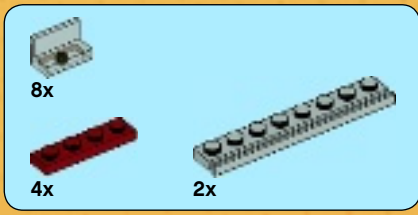

6

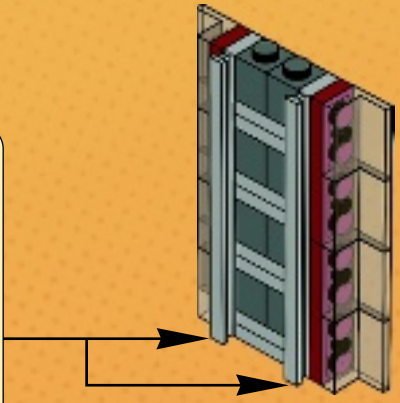
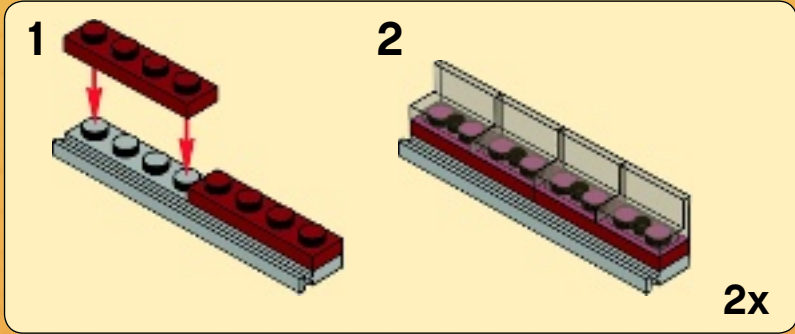

41

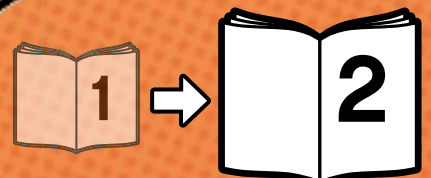
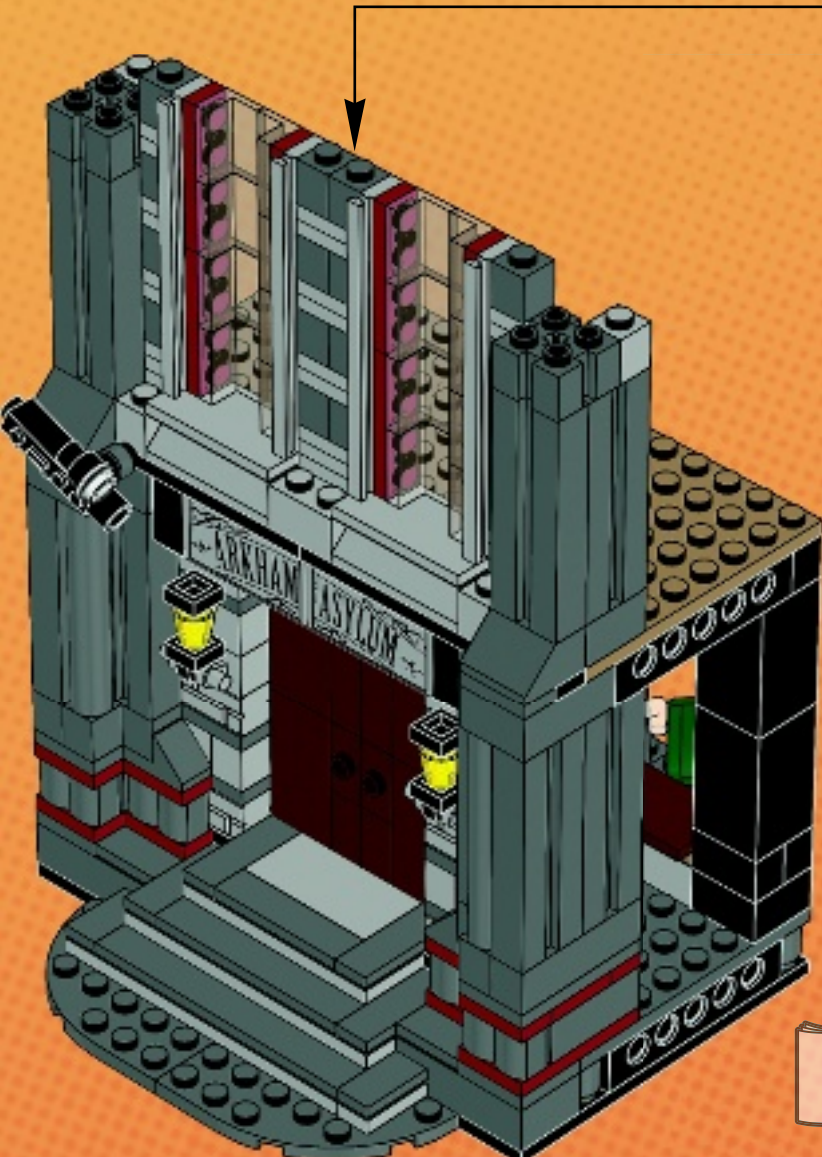



WIN!

Go to www.LEGOsurvey.com/product to fill out a survey for a chance to win a cool LEGO® Product.

No purchase necessary.

Open to all residents where not prohibited.



www.LEGOsurvey.com/product

GEWINNE!

Nimm an der Umfrage auf www.LEGOsurvey.com/product teil und hab die Chance ein cooles LEGO® Produkt zu gewinnen!

Die Teilnahme am Gewinnspiel führt zu keinerlei Kaufverpflichtungen. Teilnahme in allen nicht ausgeschlossenen Ländern möglich.

WIN!

Ga naar www.LEGOsurvey.com/product, vul een enquêteformulier in en maak kans op een cool LEGO® product.

Geen aankoopverplichting. Iedereen mag deelnemen, uitgezonderd ingezetenden van landen waar een enquêteverbod geldt.

GAGNE!

Visite www.LEGOsurvey.com/product pour répondre à un questionnaire et avoir une chance de gagner un produit LEGO® très cool!

Aucune obligation d'achat. Ouvert à tous les résidents des pays autorisés.

当てよう!

www.LEGOsurvey.com/product にアクセスして、アンケートにご記入ください。当選者にはレゴ®製品を差し上げます。

お買い上げの必要はありません。禁止されていない限り、すべての皆様にご利用いただけます。