



CITY

60050



 [LEGO.com/city](https://www.lego.com/city)

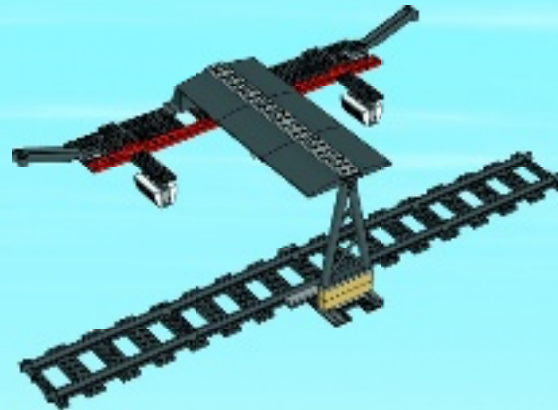
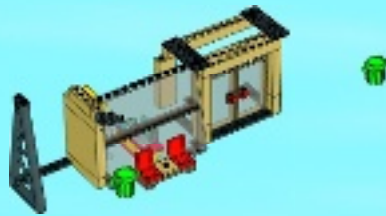
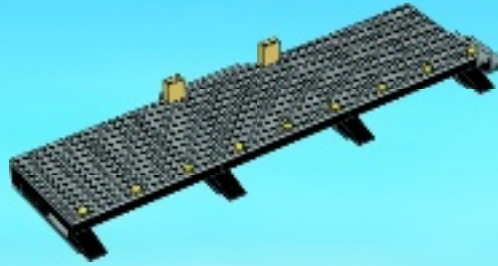

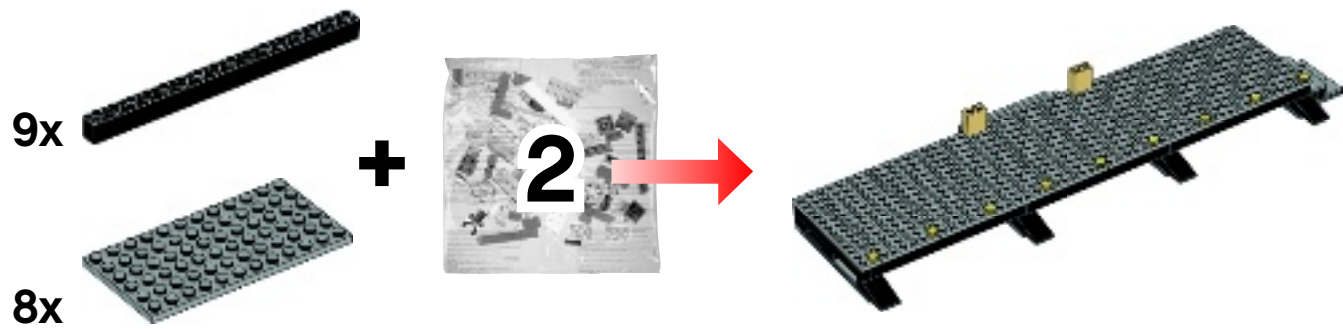

1

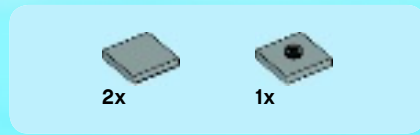

2

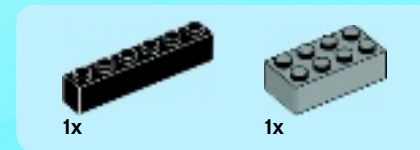

3

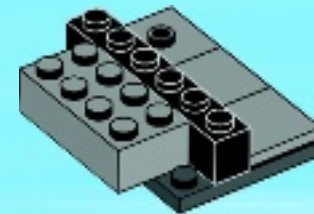



2x

4

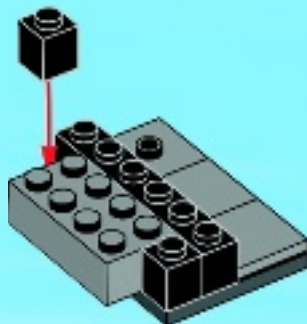

2x



1x

5

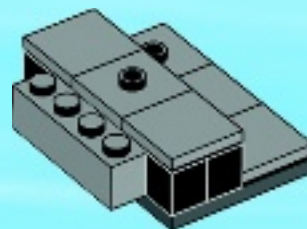

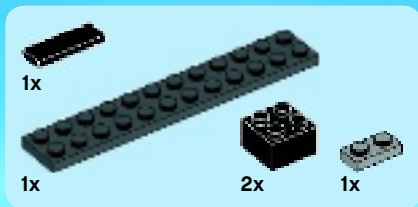

6

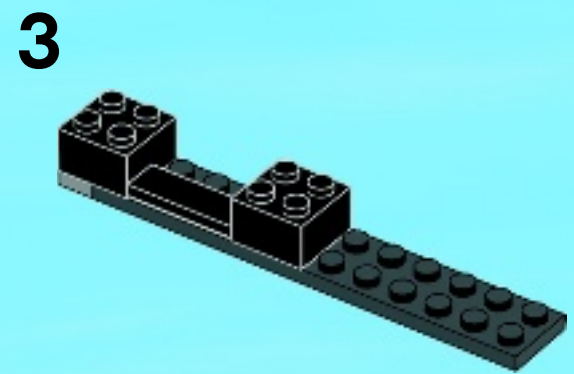
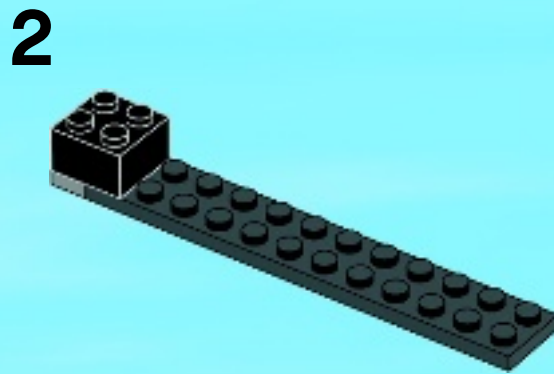
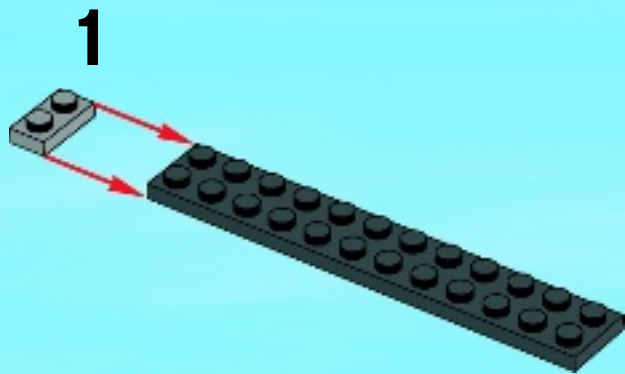



1x

7

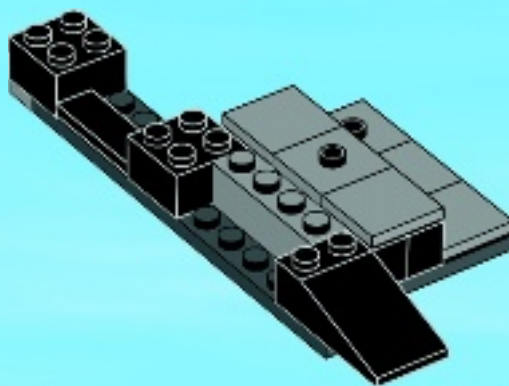
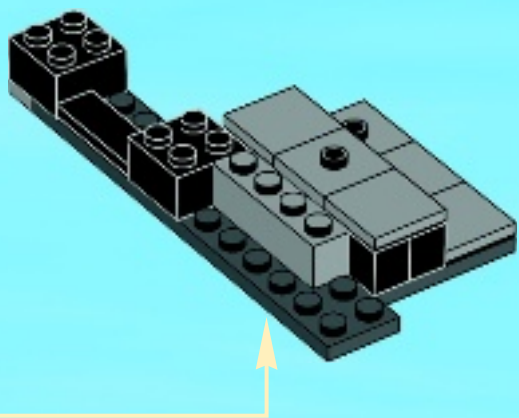



8

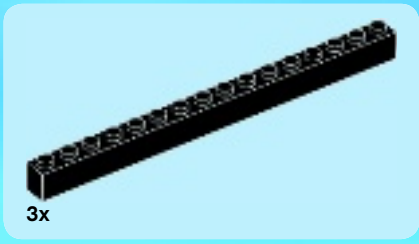
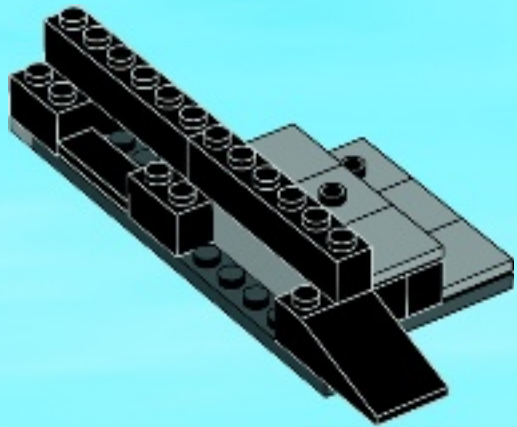

9

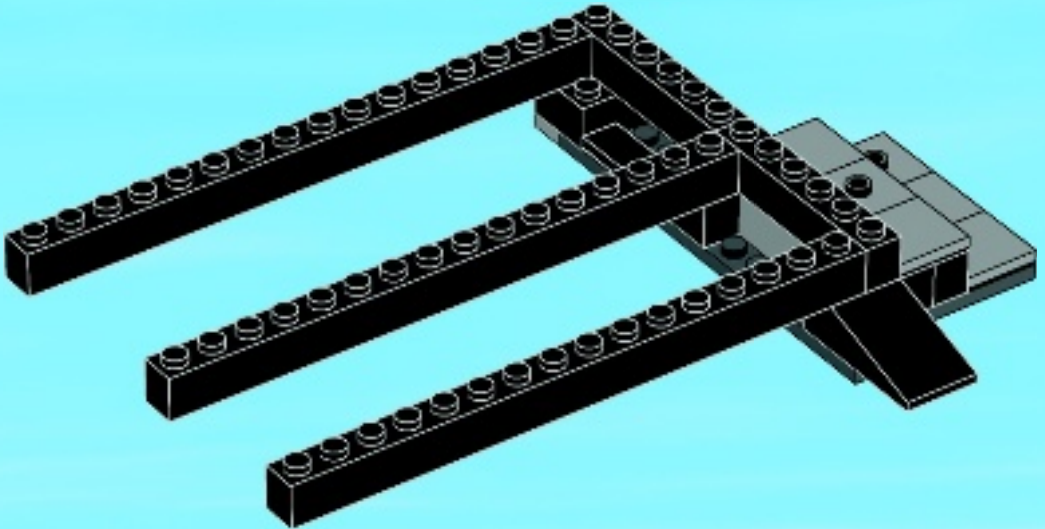

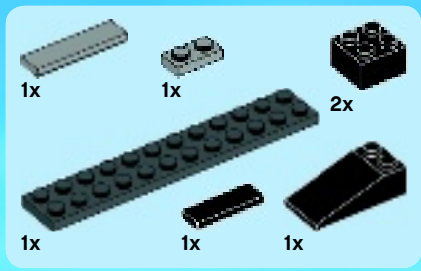

10

1

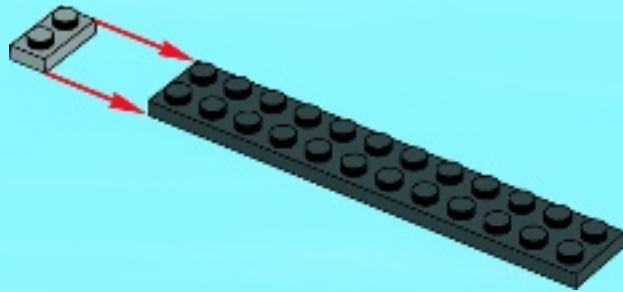

2

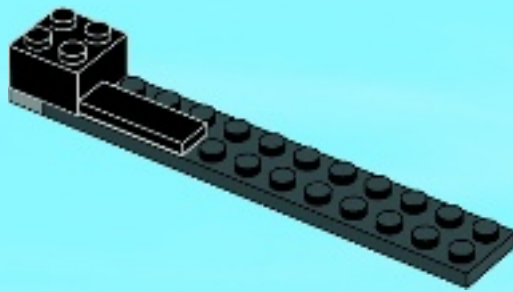

3

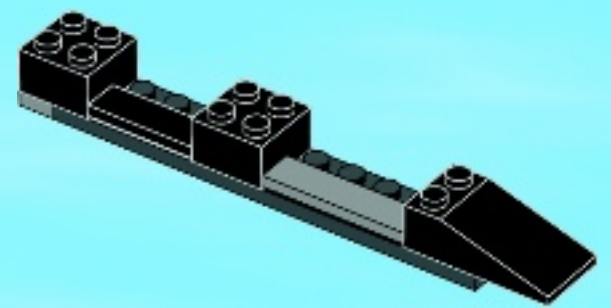

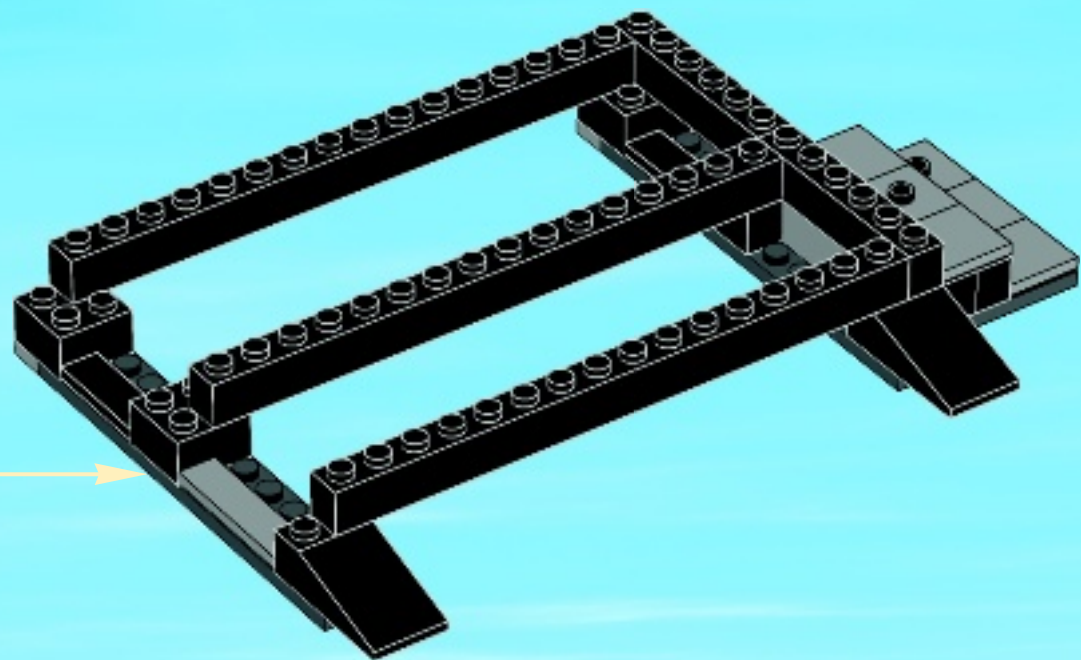



11

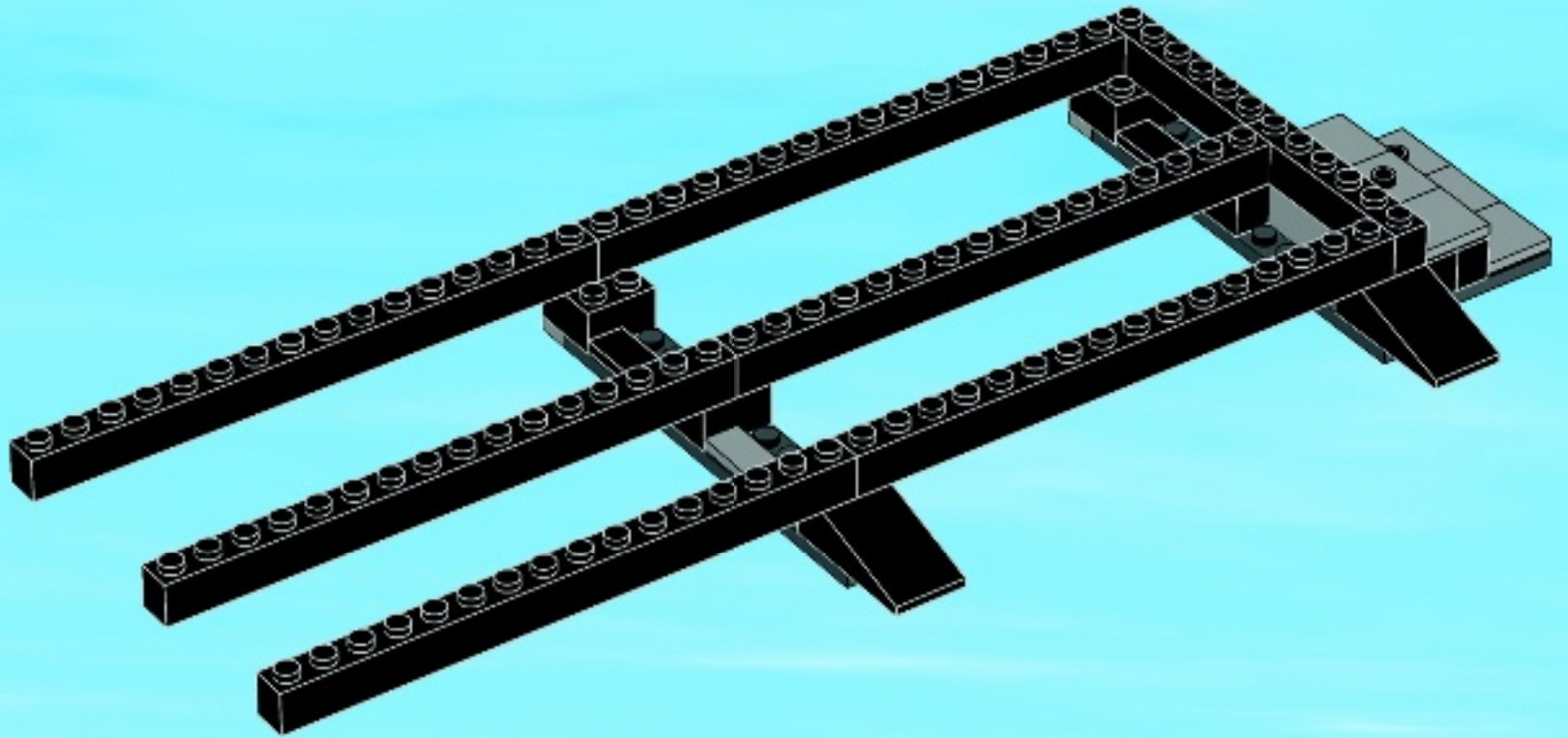

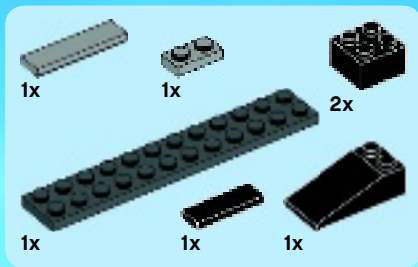

12

1

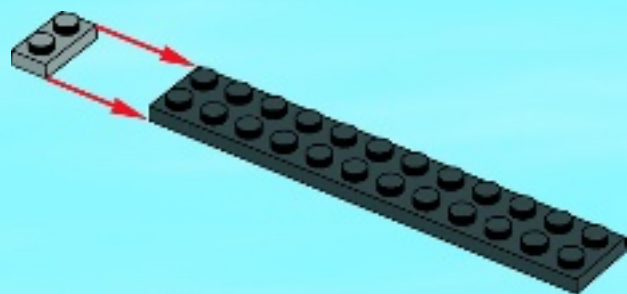

2

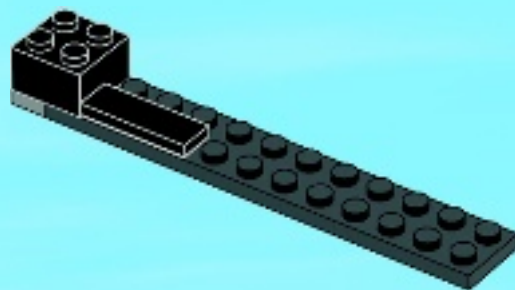

3

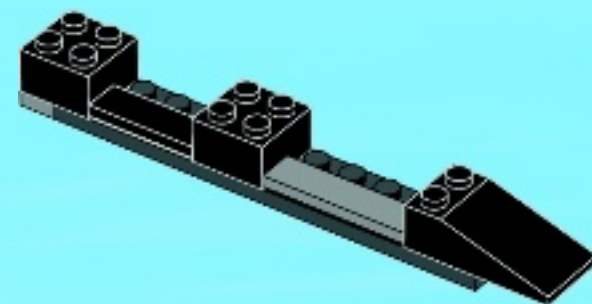

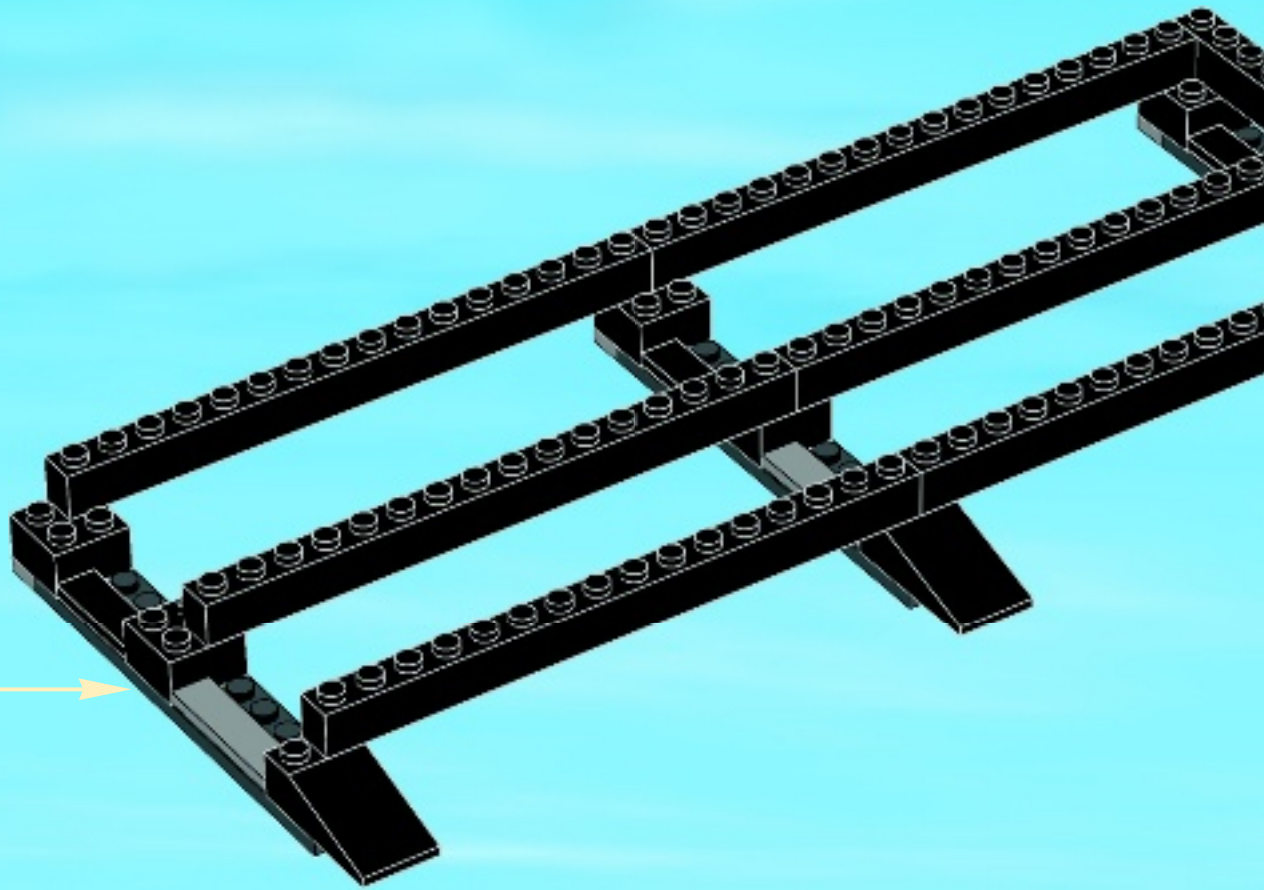



13

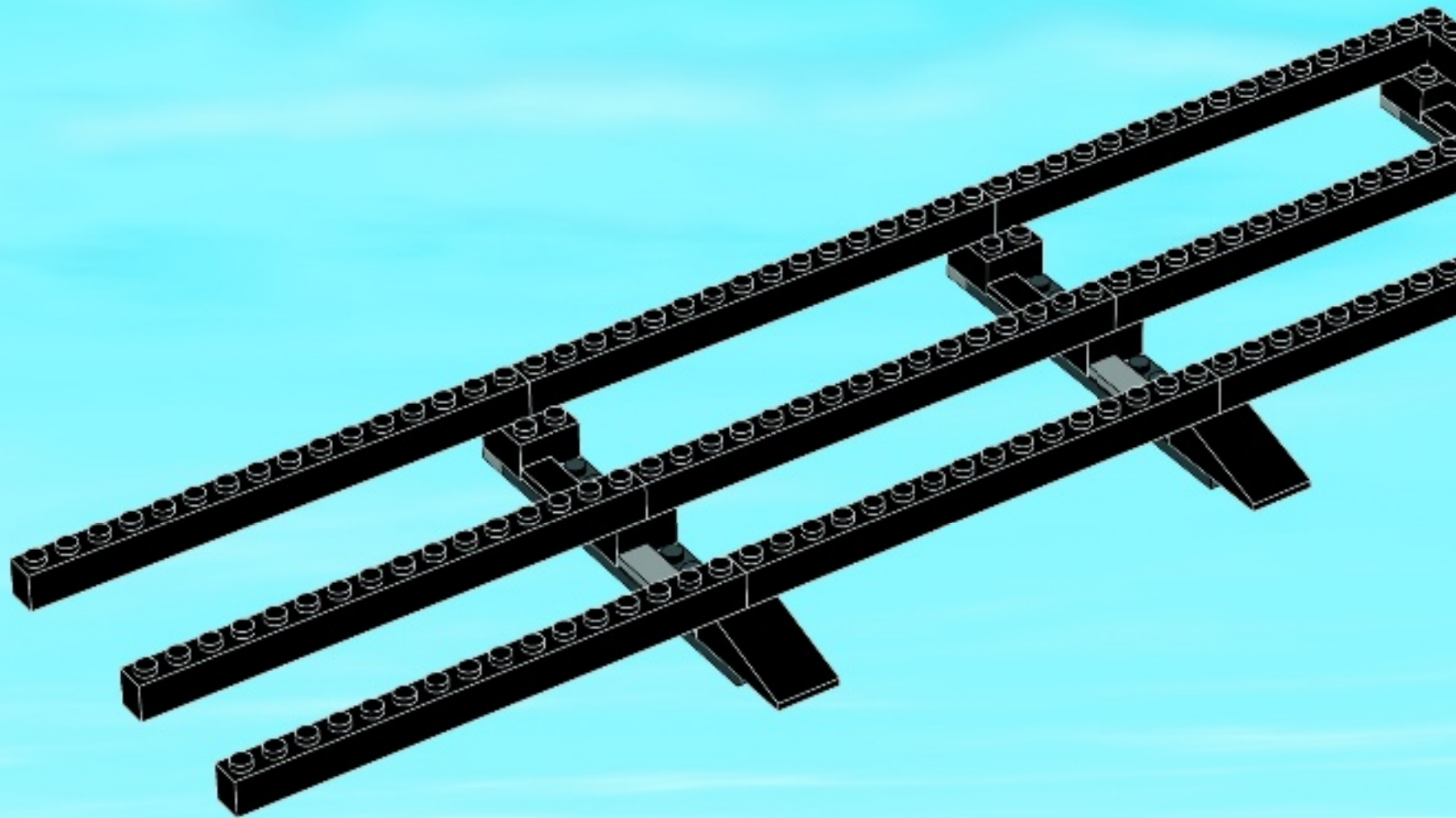

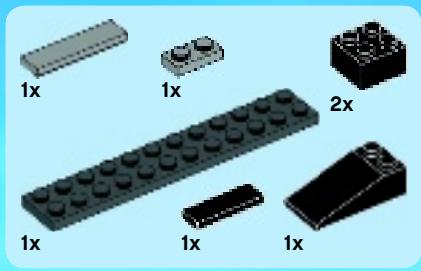

14

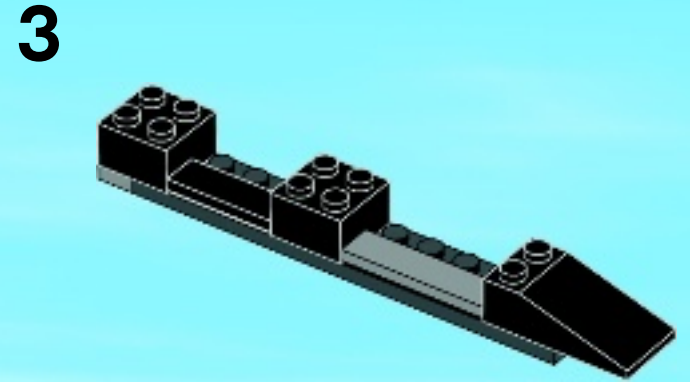
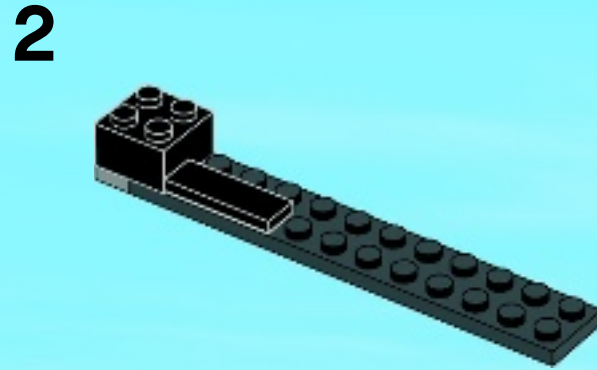
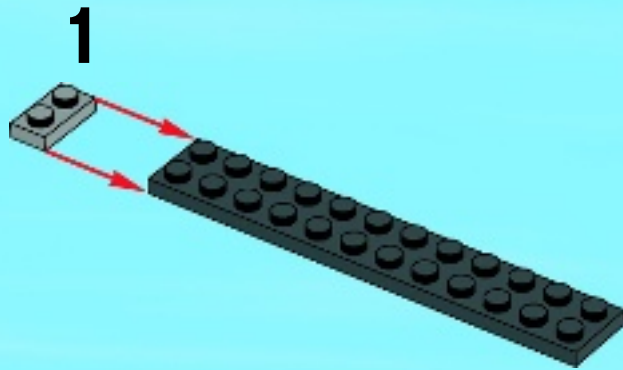

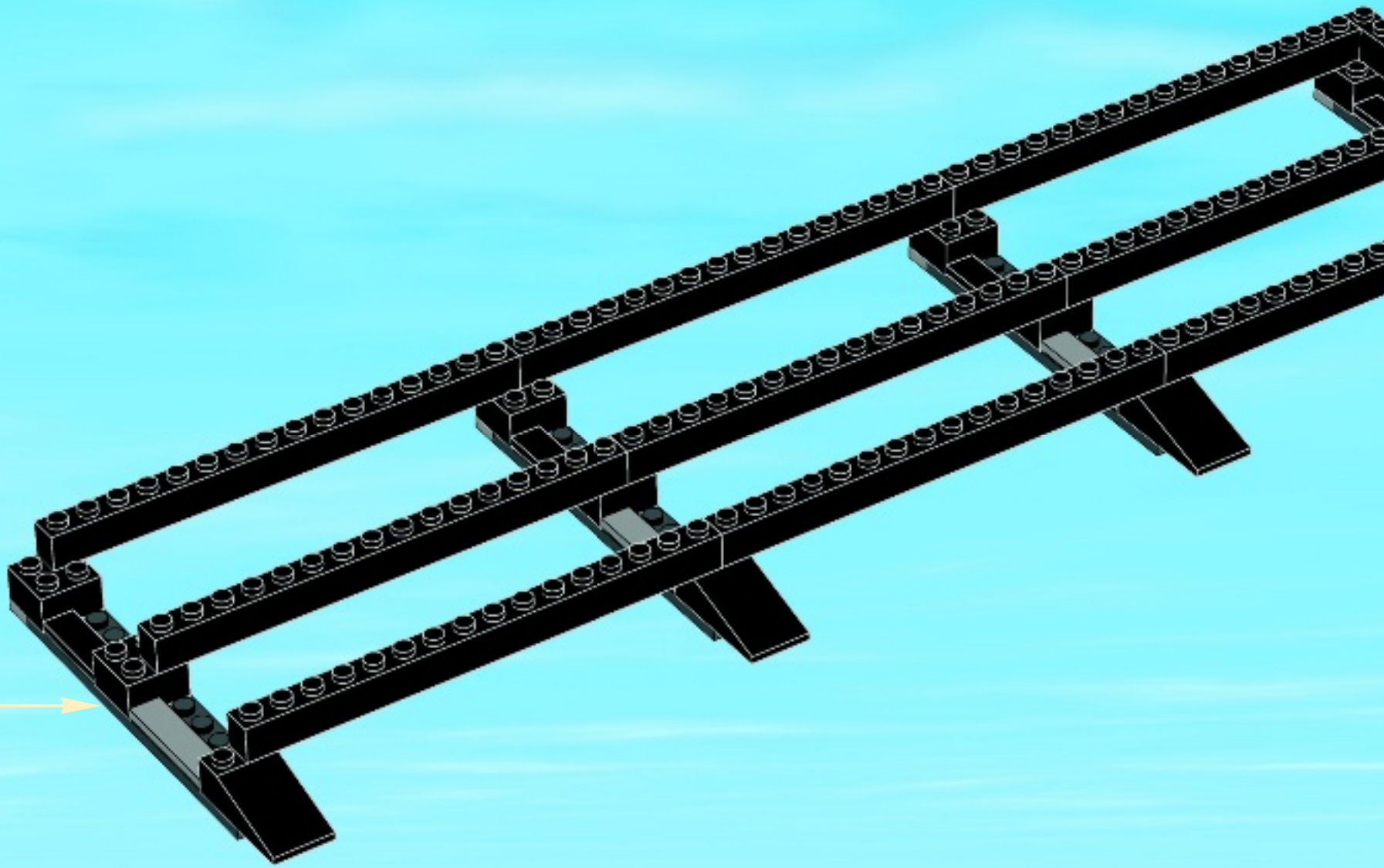



15

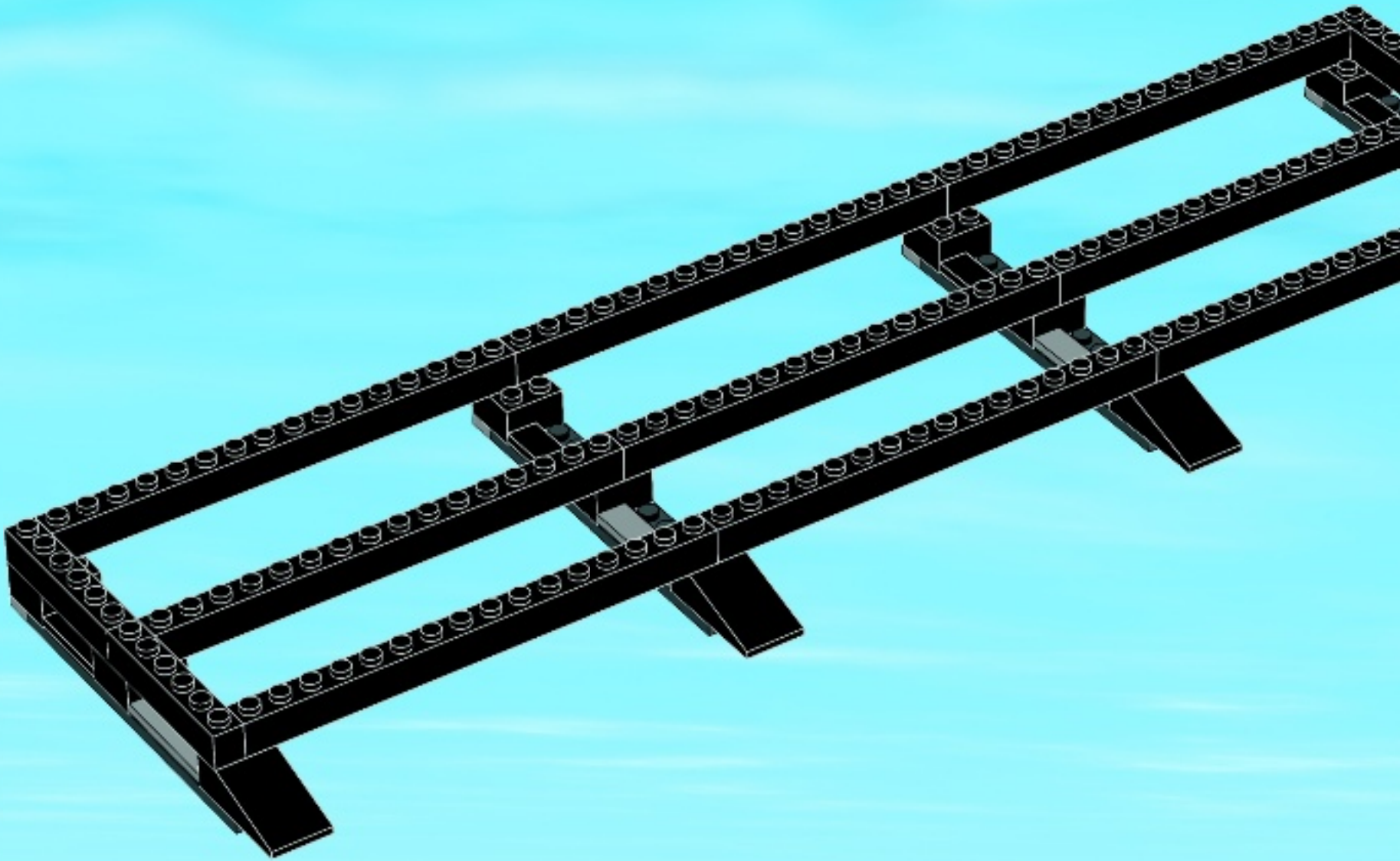

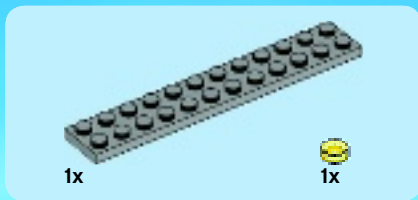

16

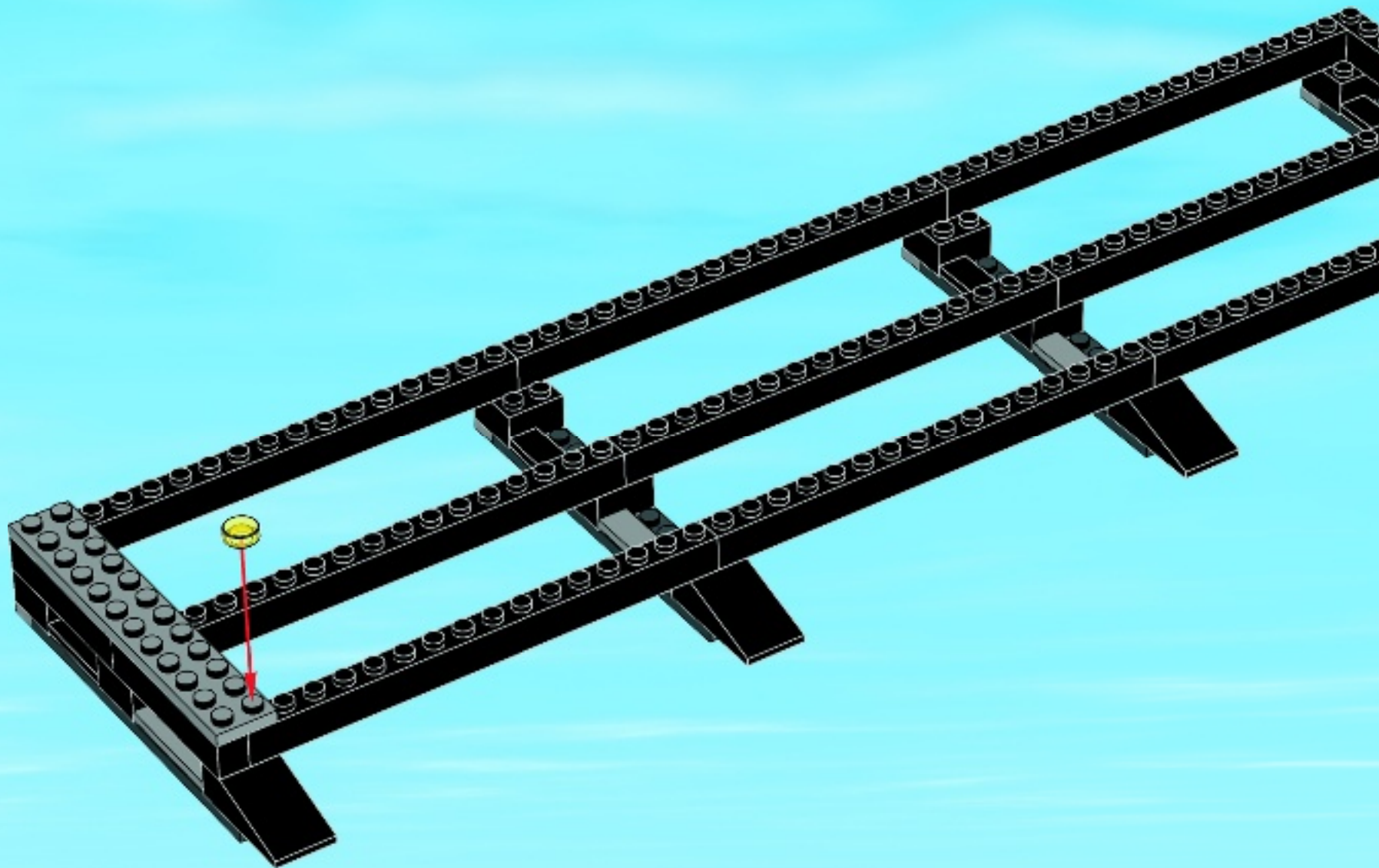

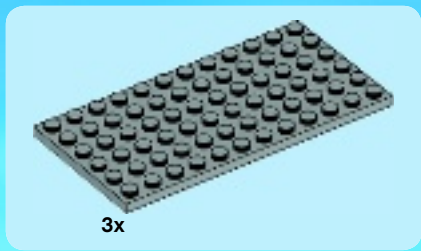

17

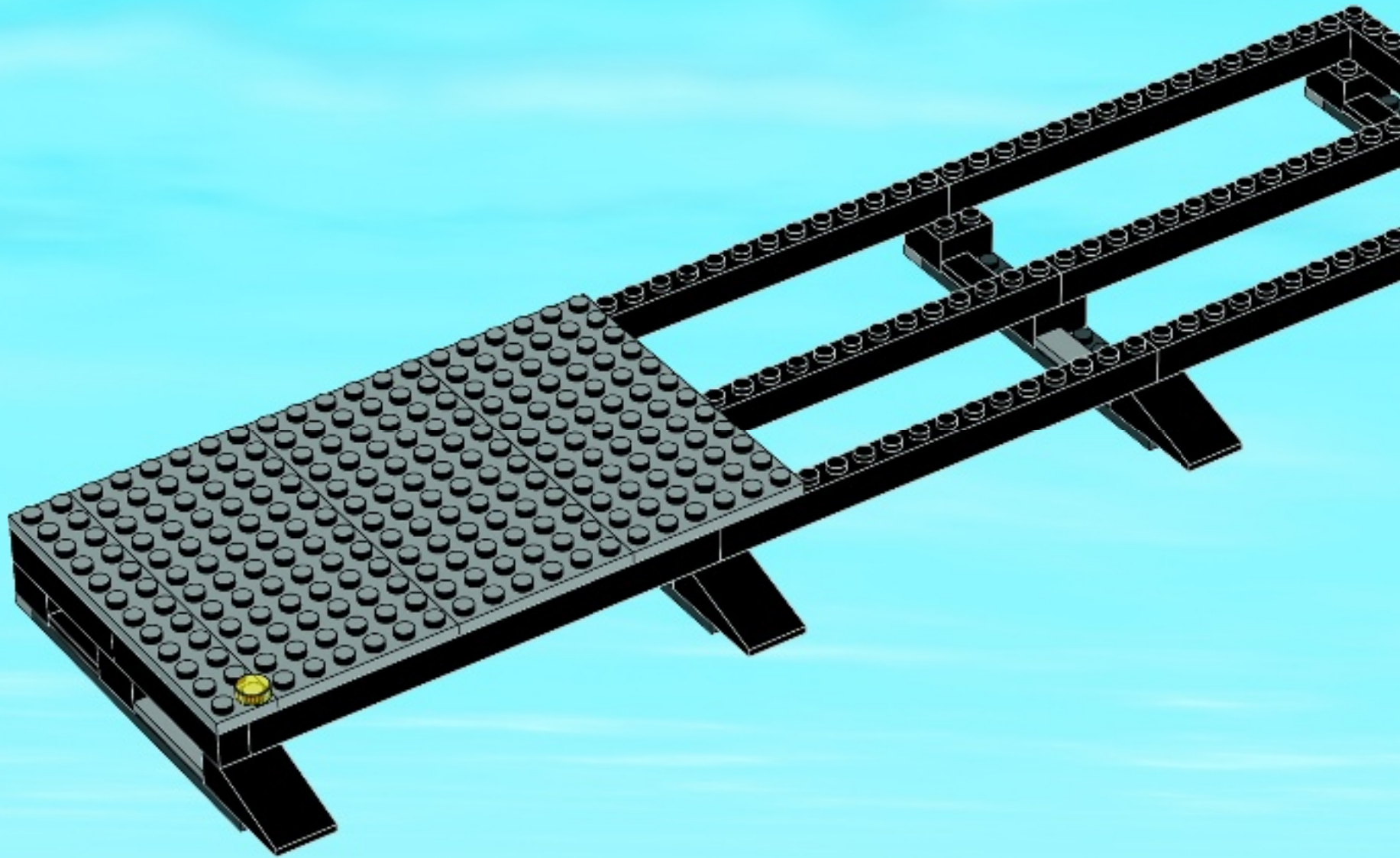



1x



3x

18

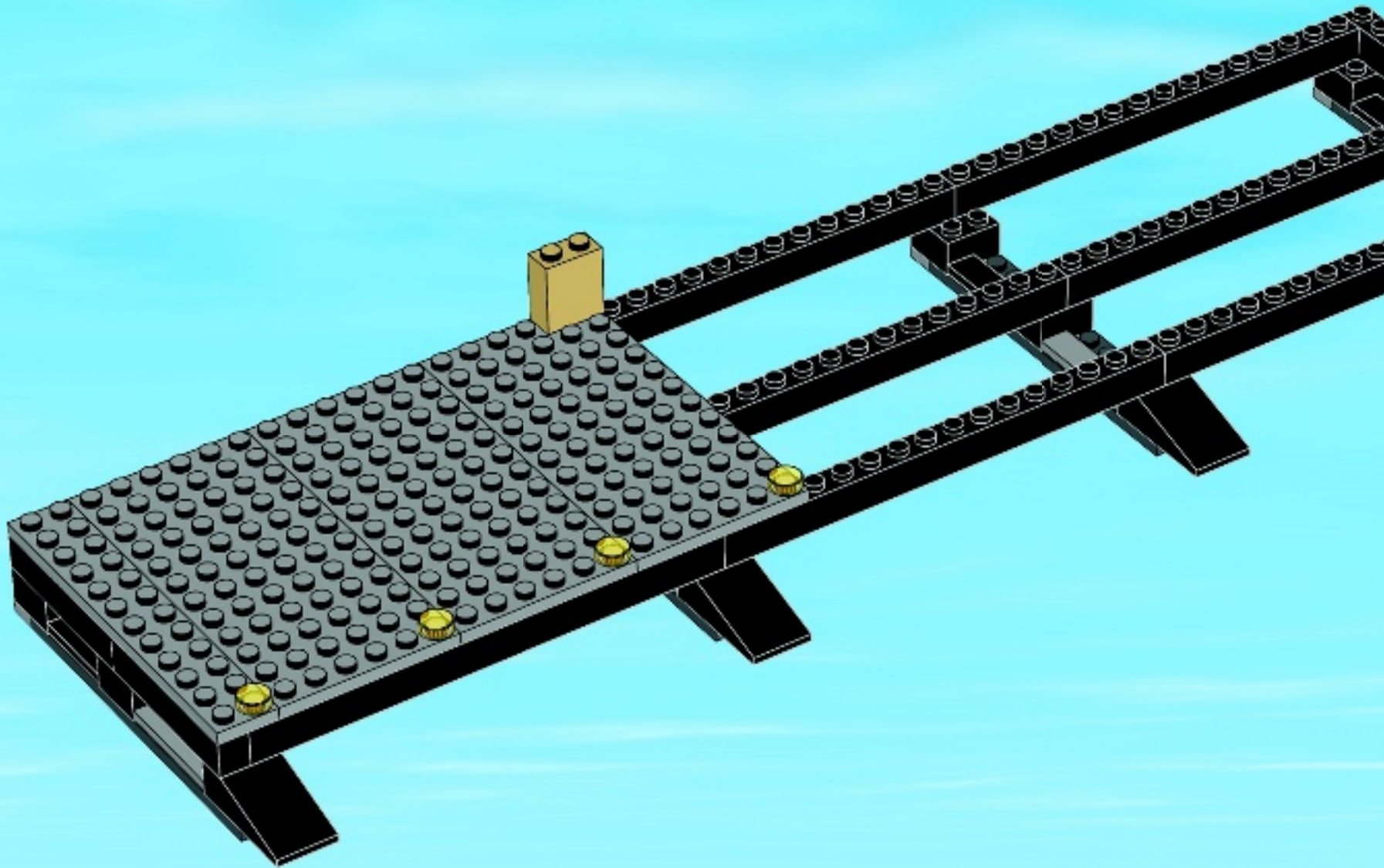

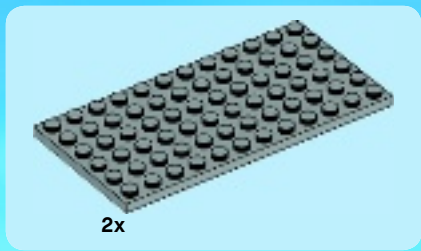

19

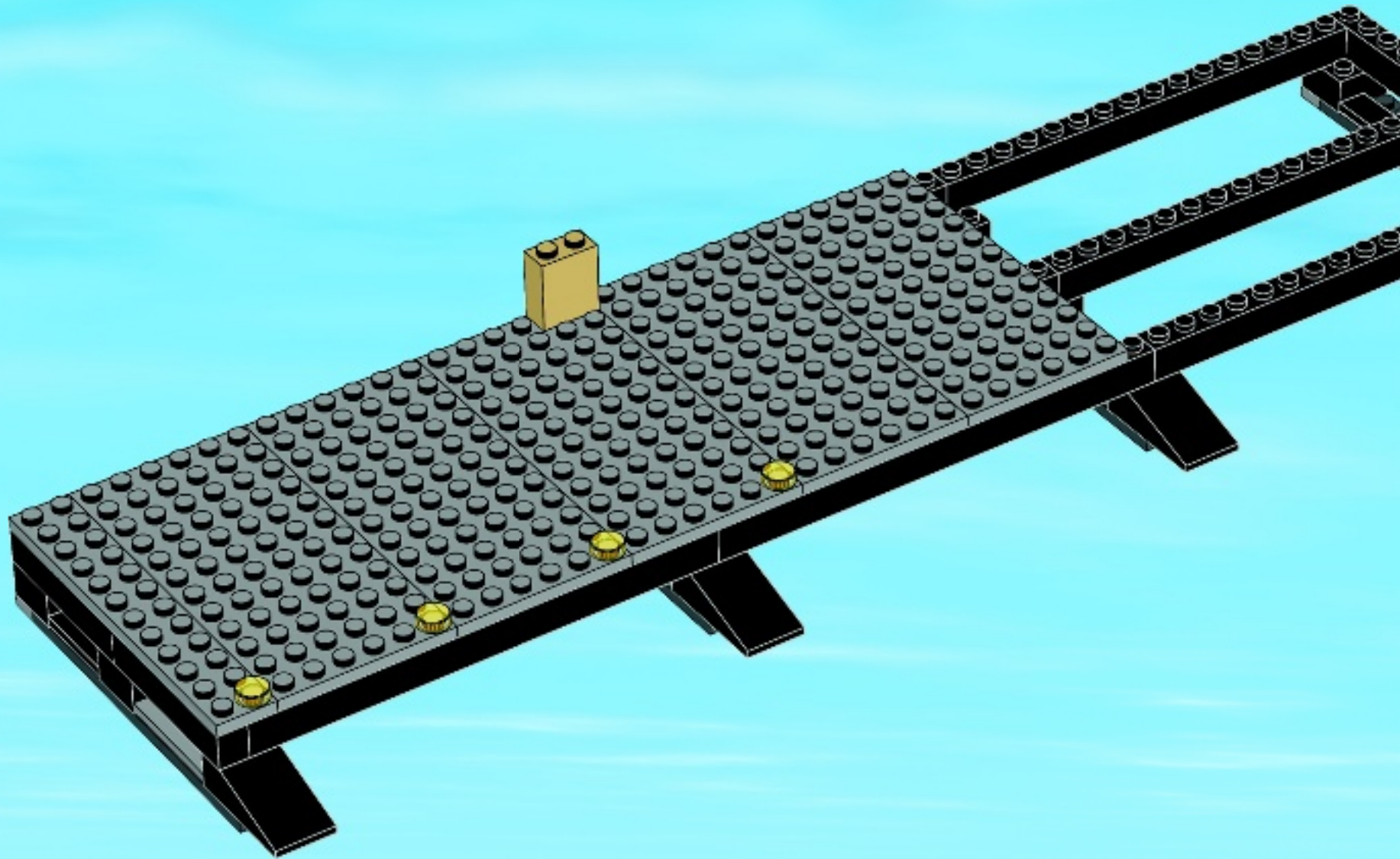



1x



2x

20

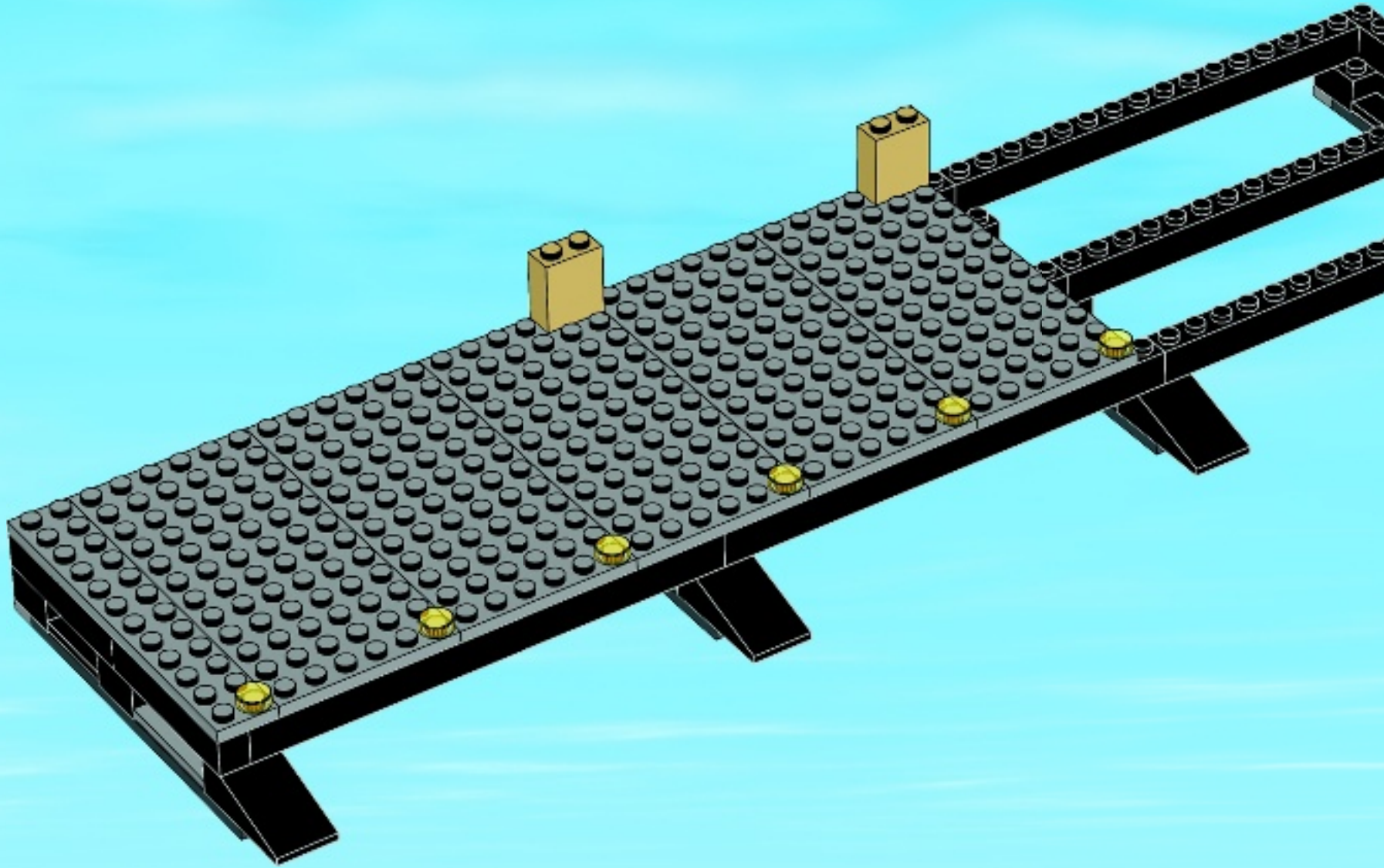

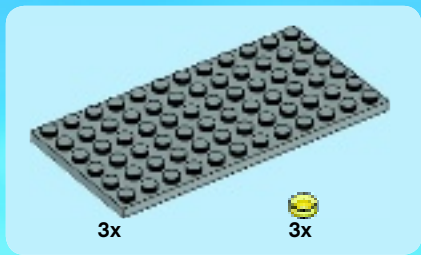

21

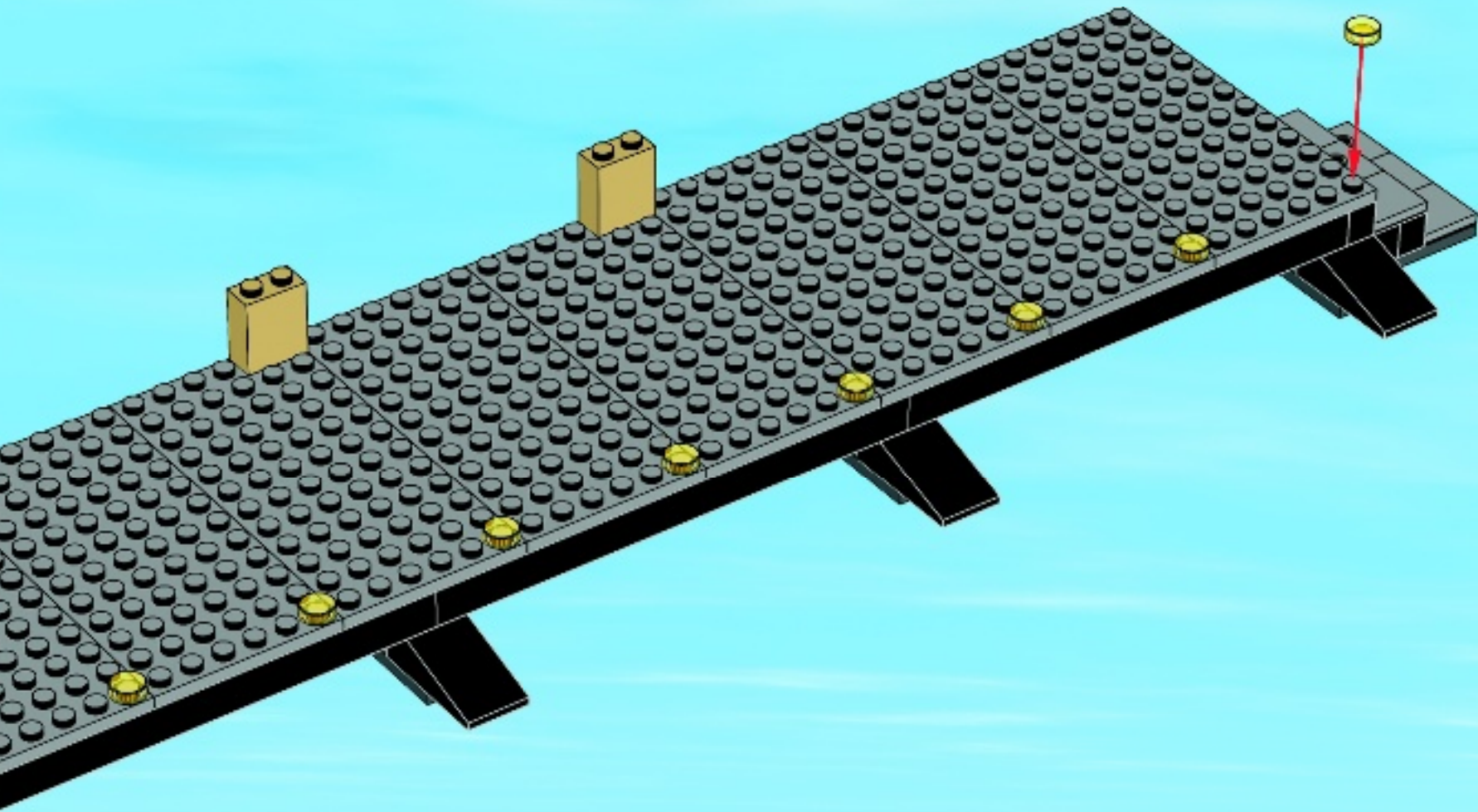

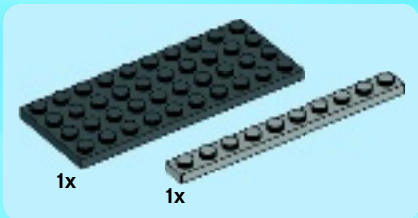
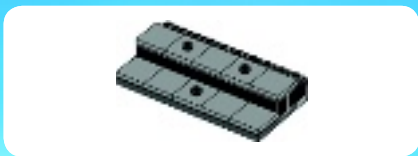

1

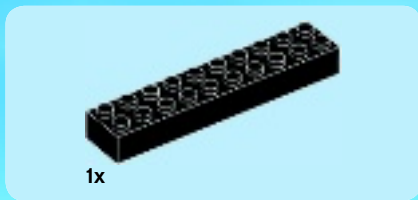
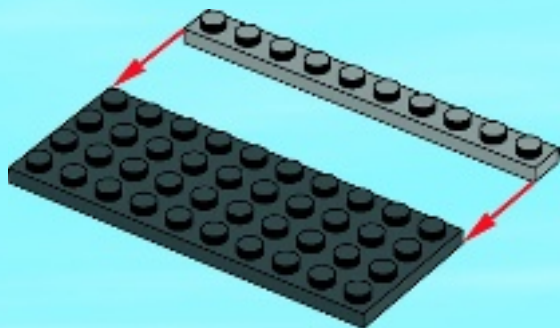

2

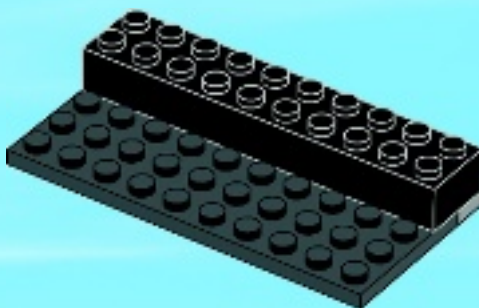

3

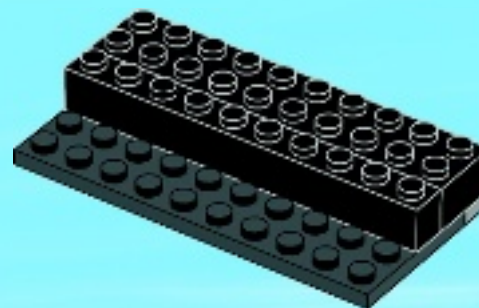



4x



1x

4

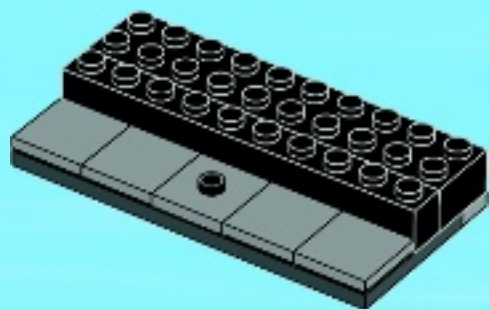

3x



2x

5

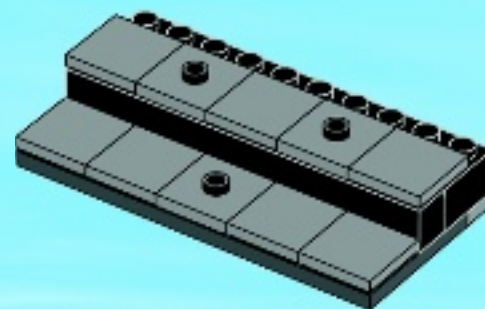

22

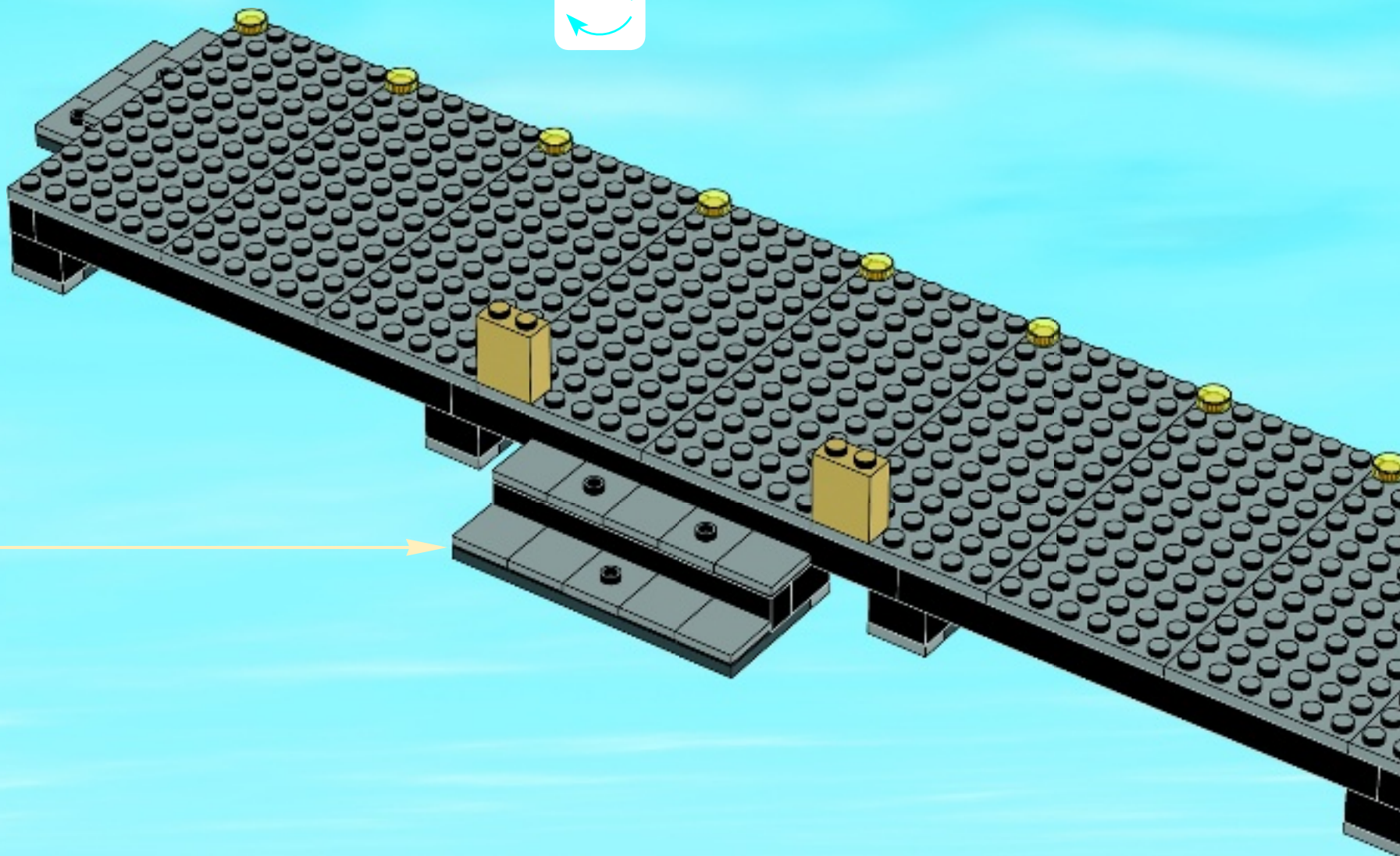

3

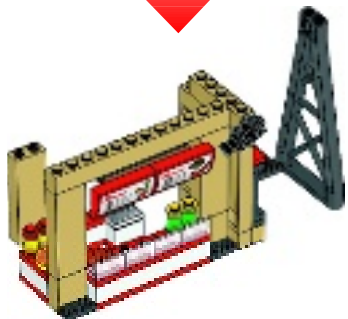

1x

23

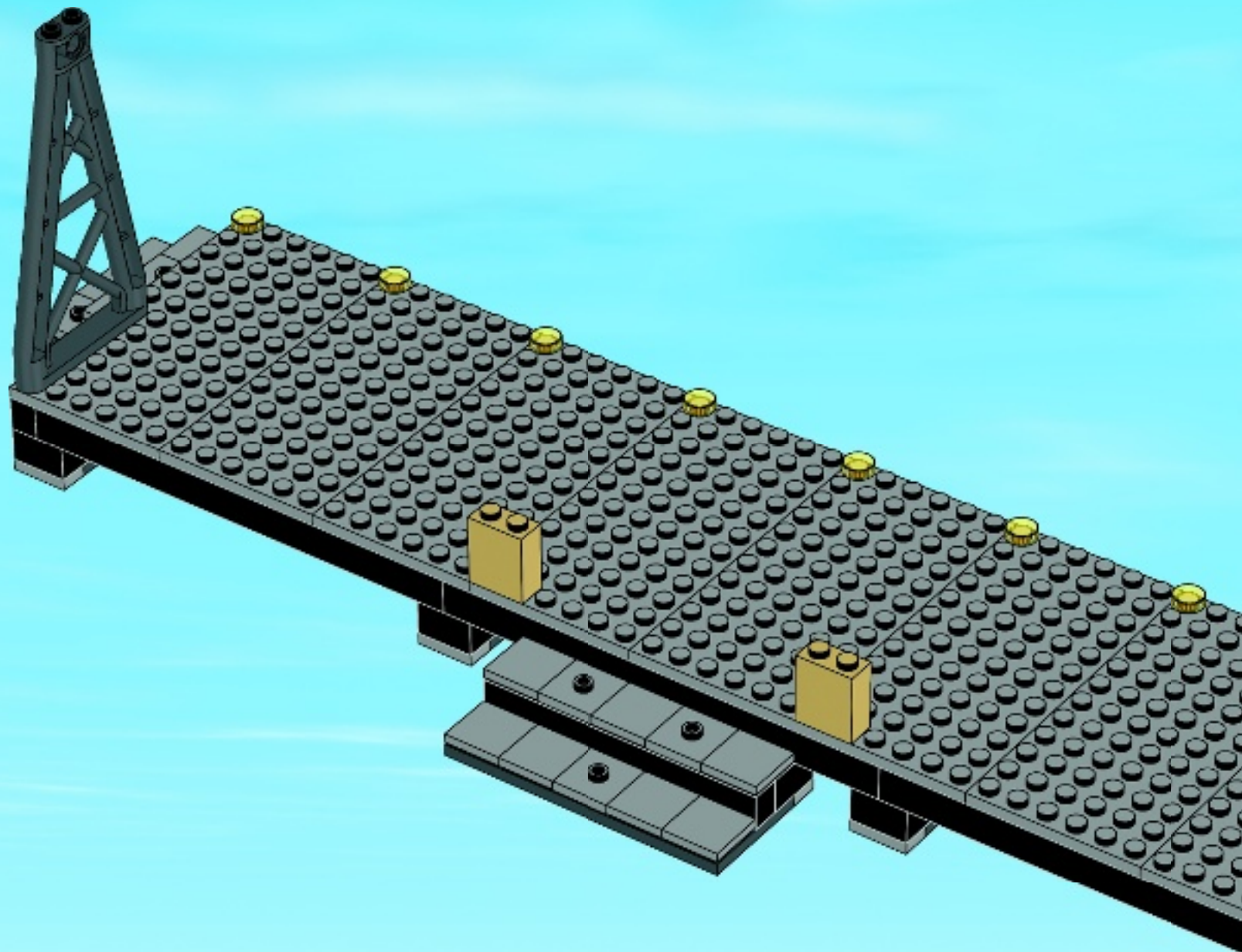



2x

24

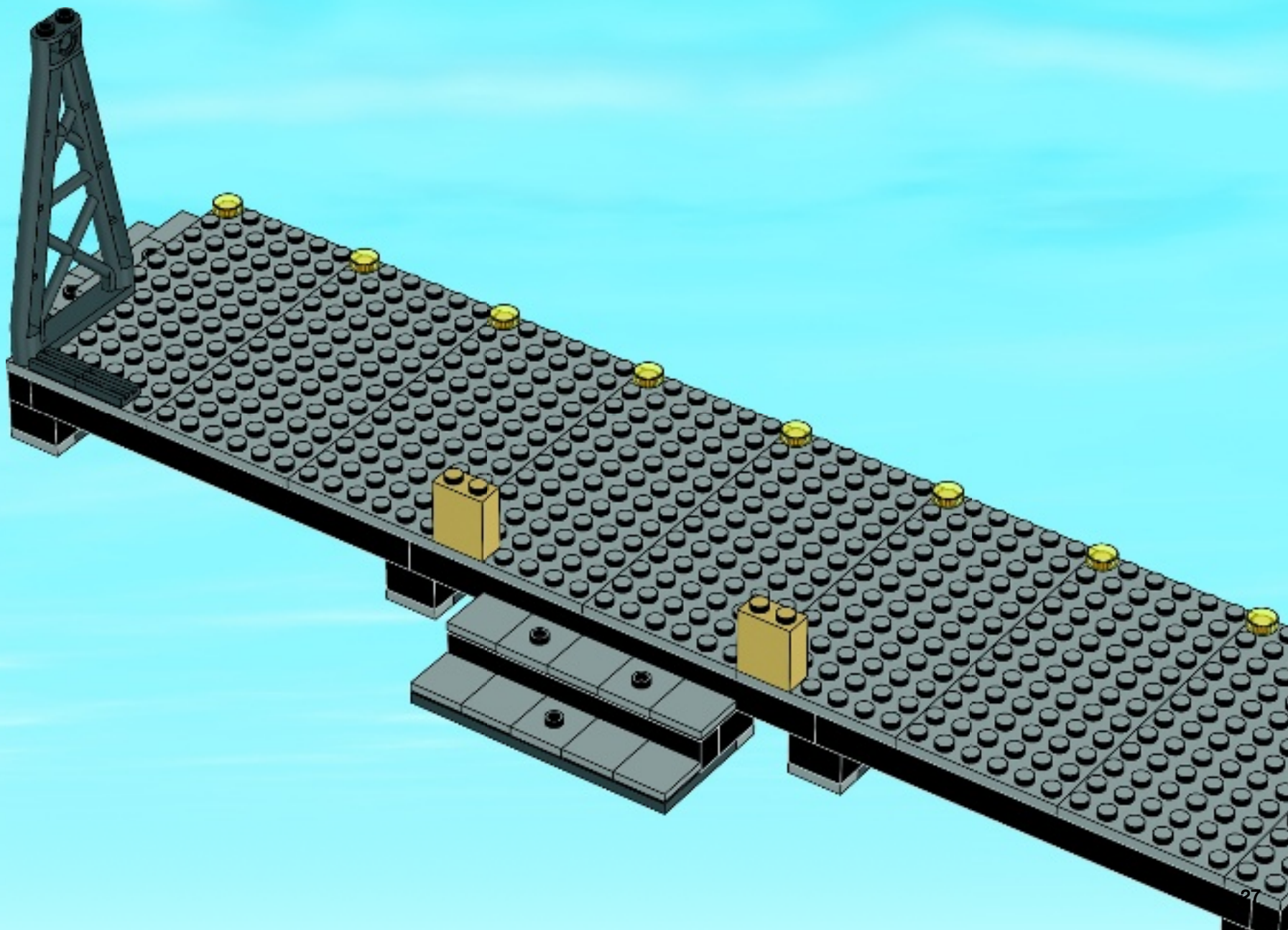

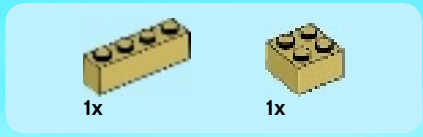

1

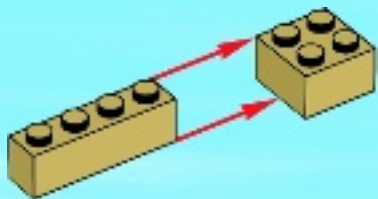

2

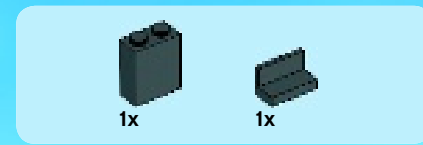
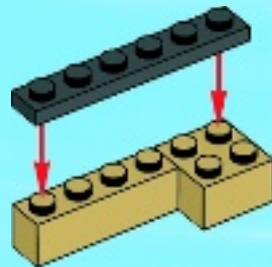

3

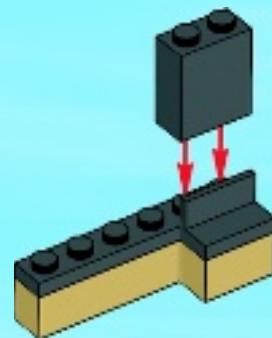

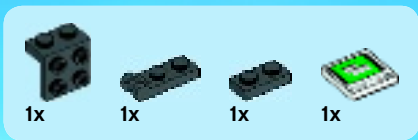

4

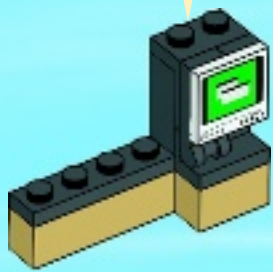
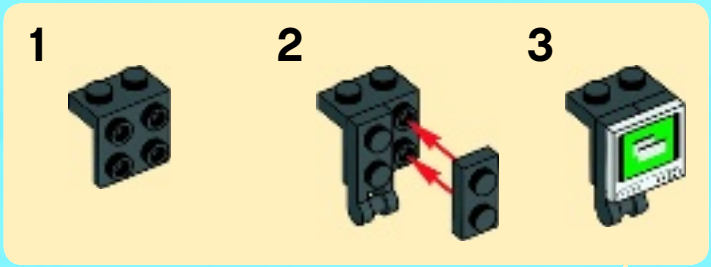

5

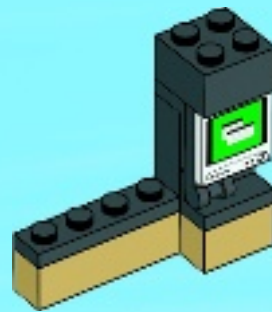

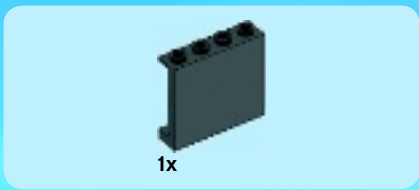

6

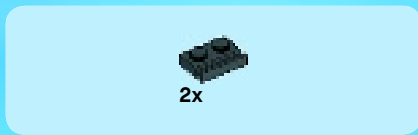
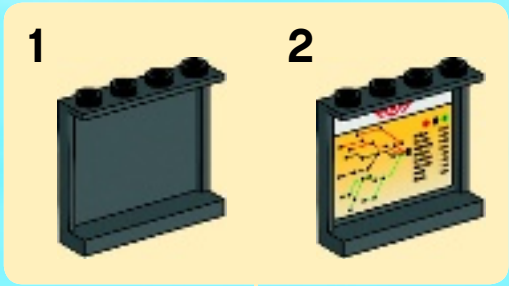

7

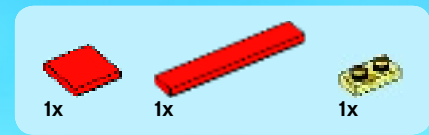

8

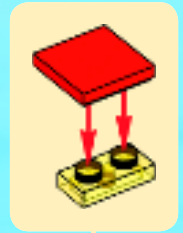

25

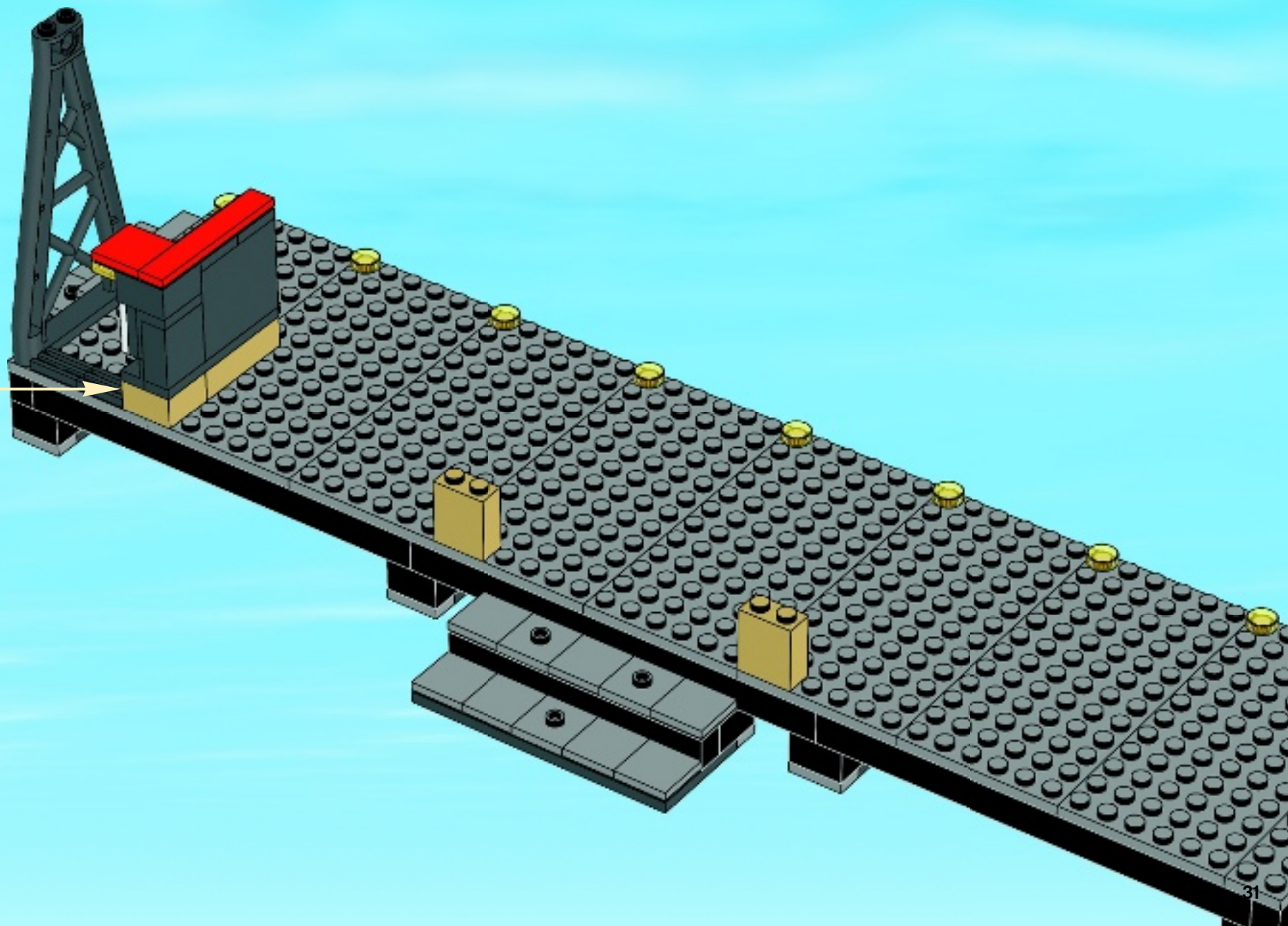



26

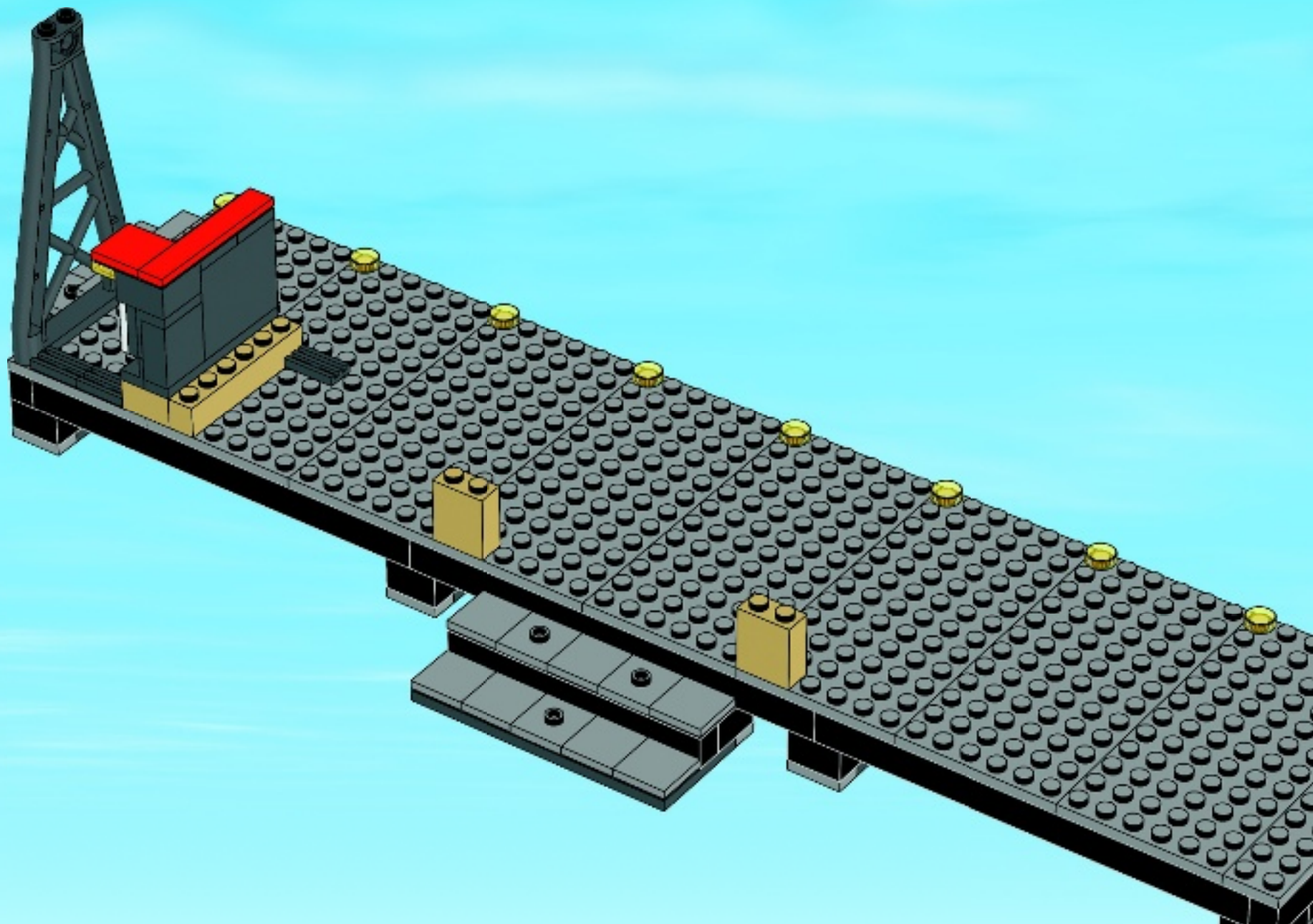

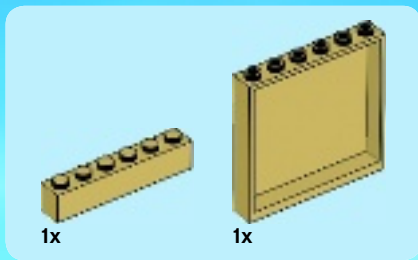

27

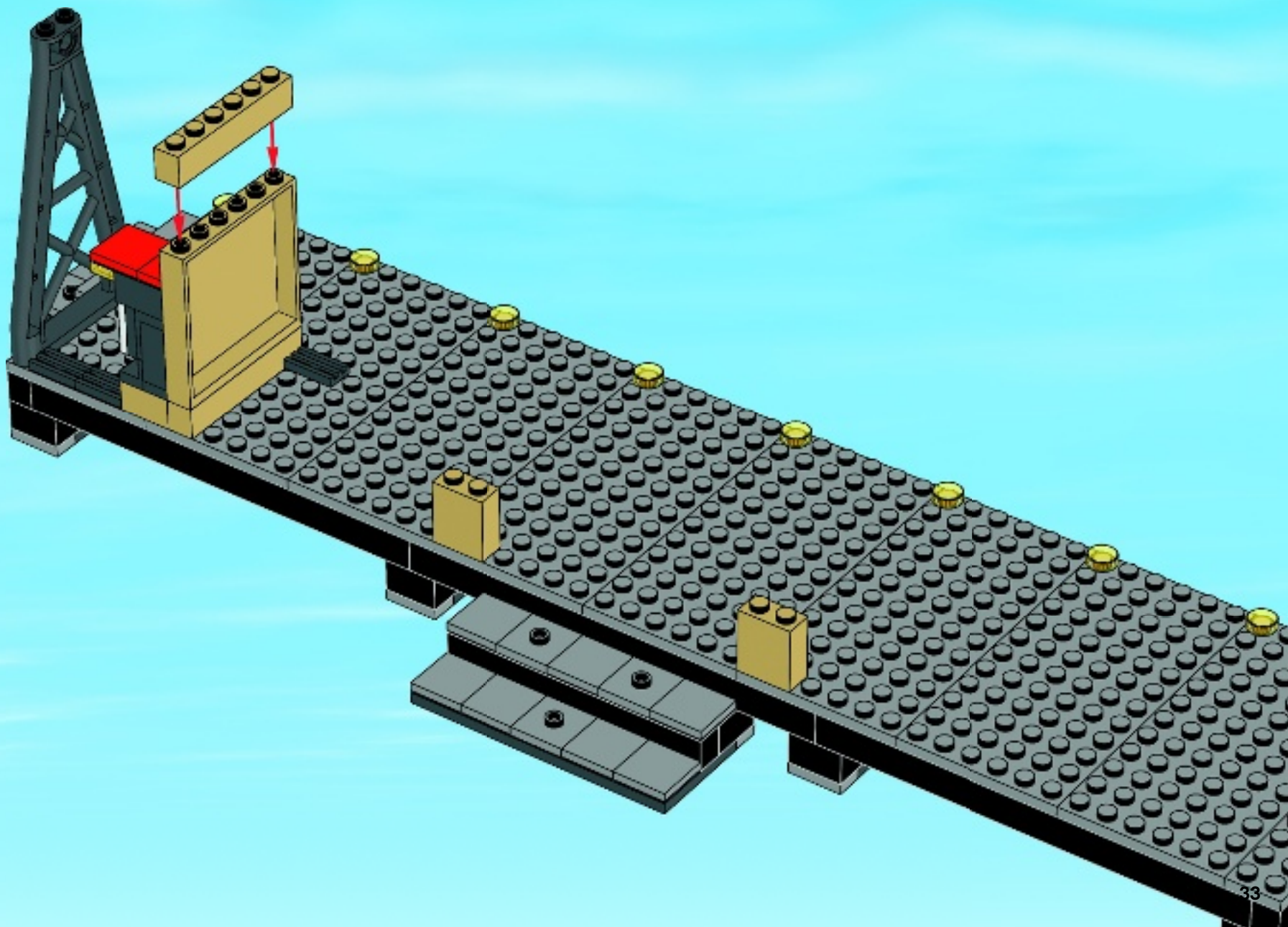

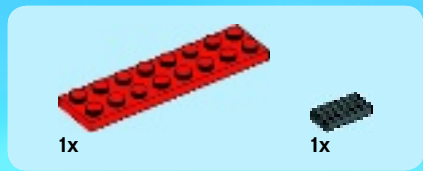

28

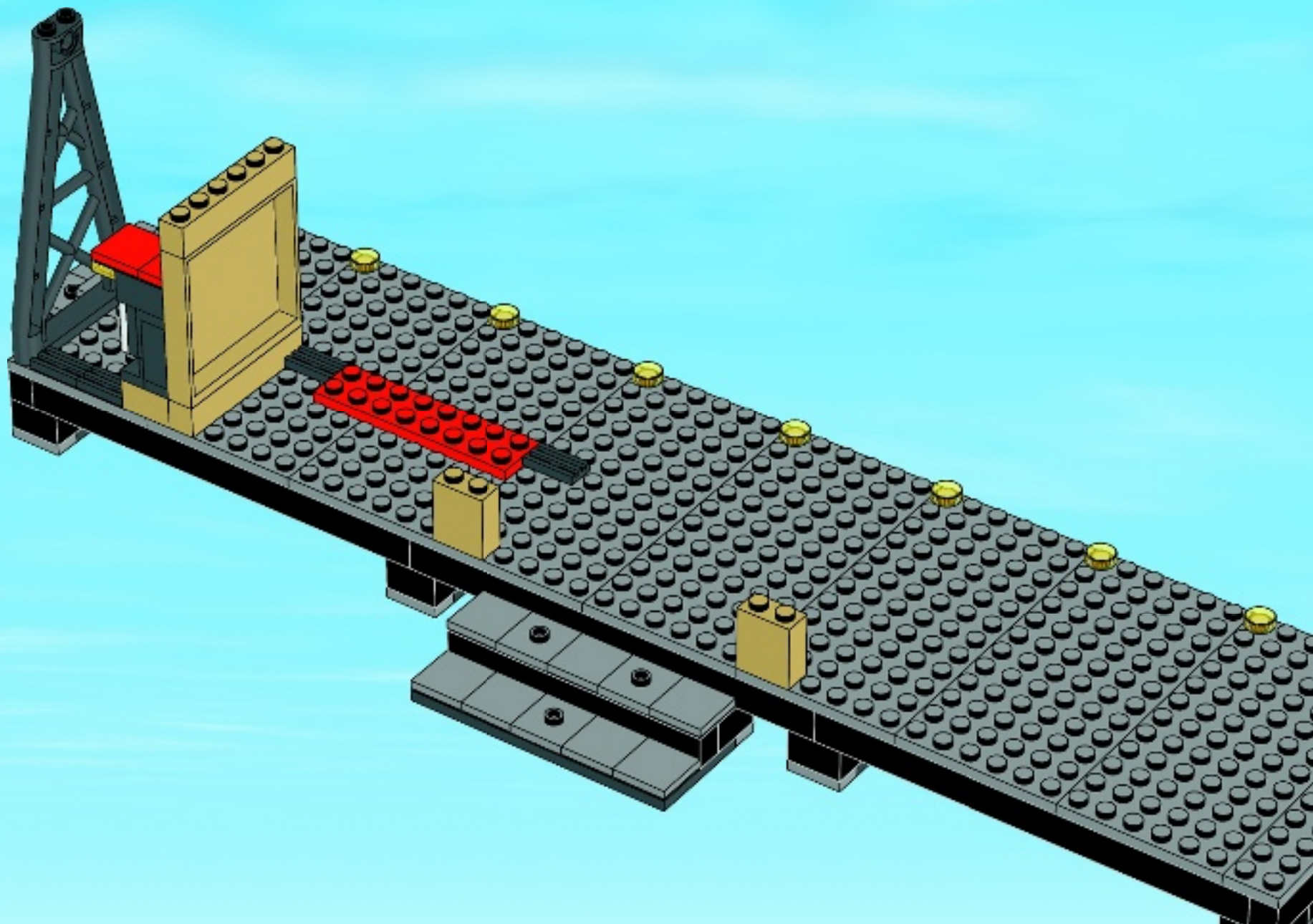



2x

29

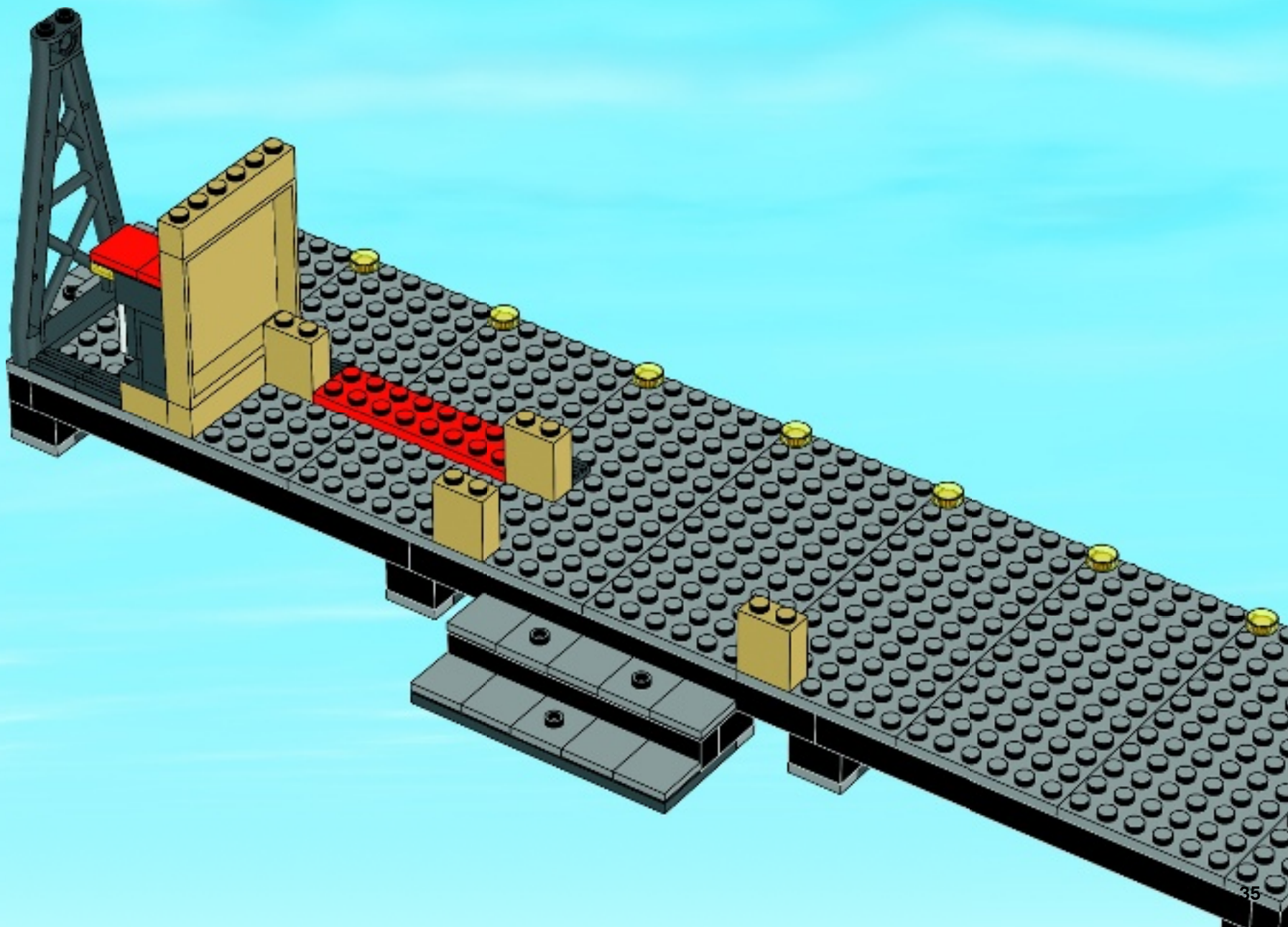



1x



1x

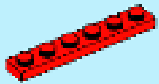

1x

30

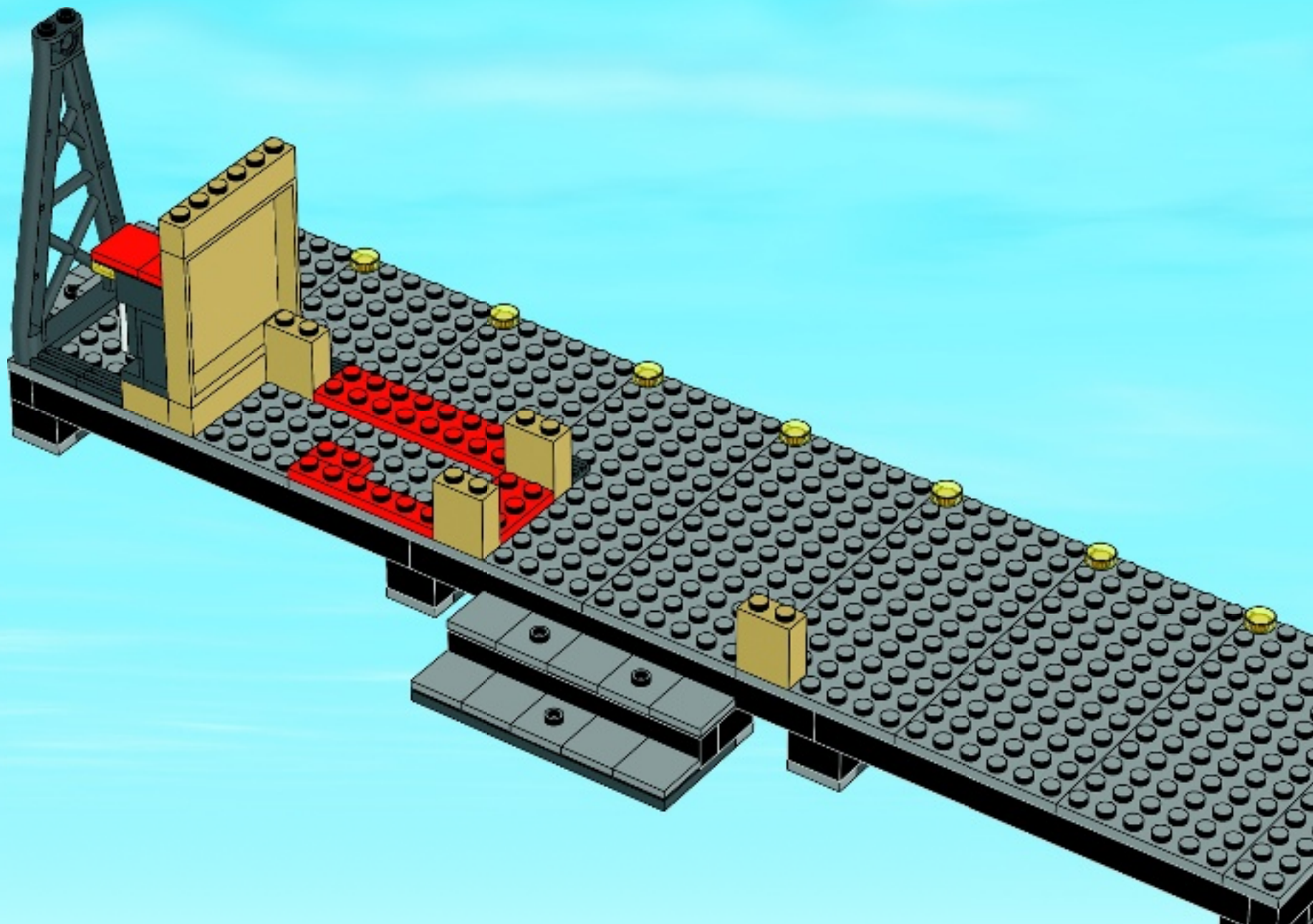

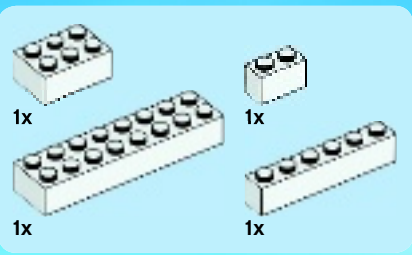

31

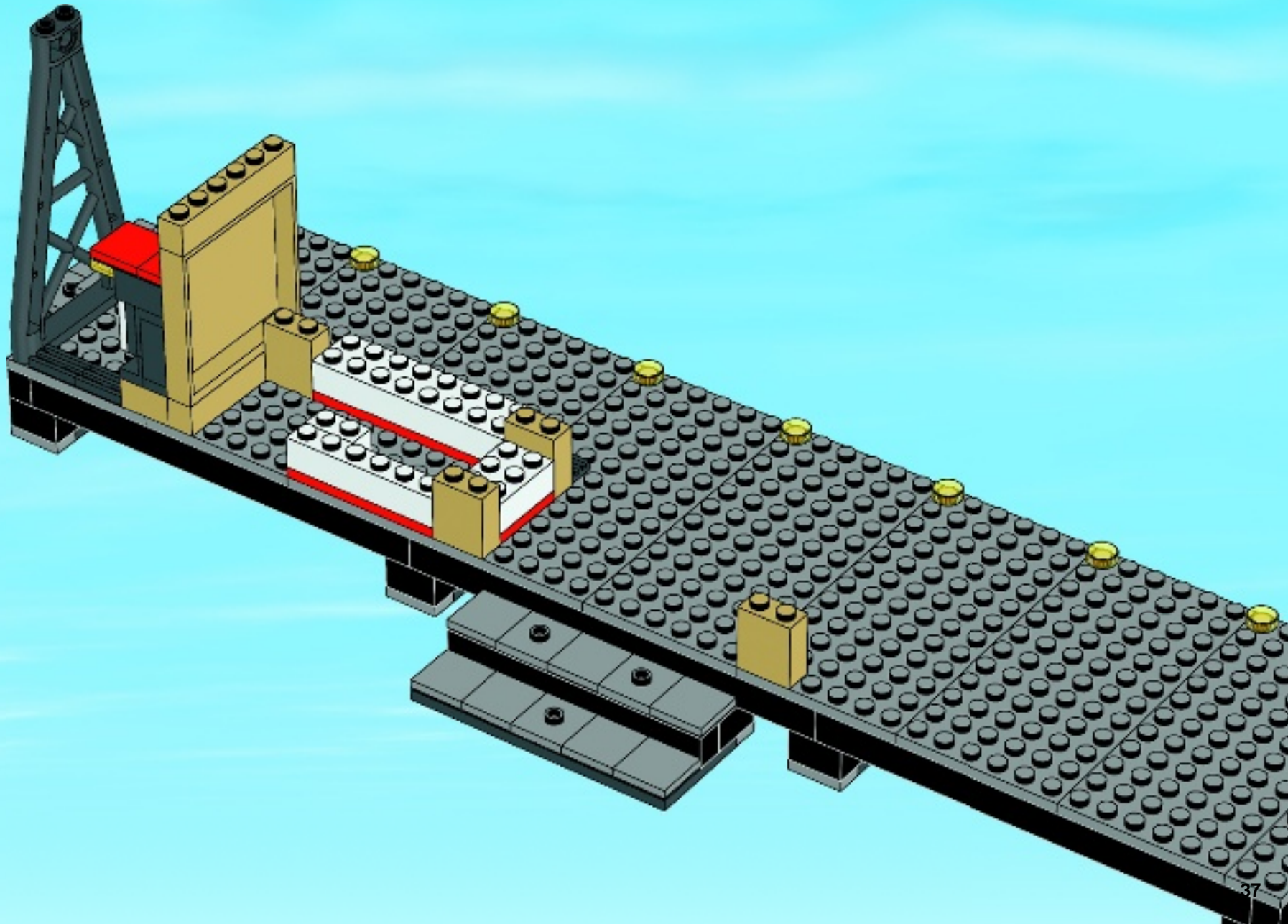







2x

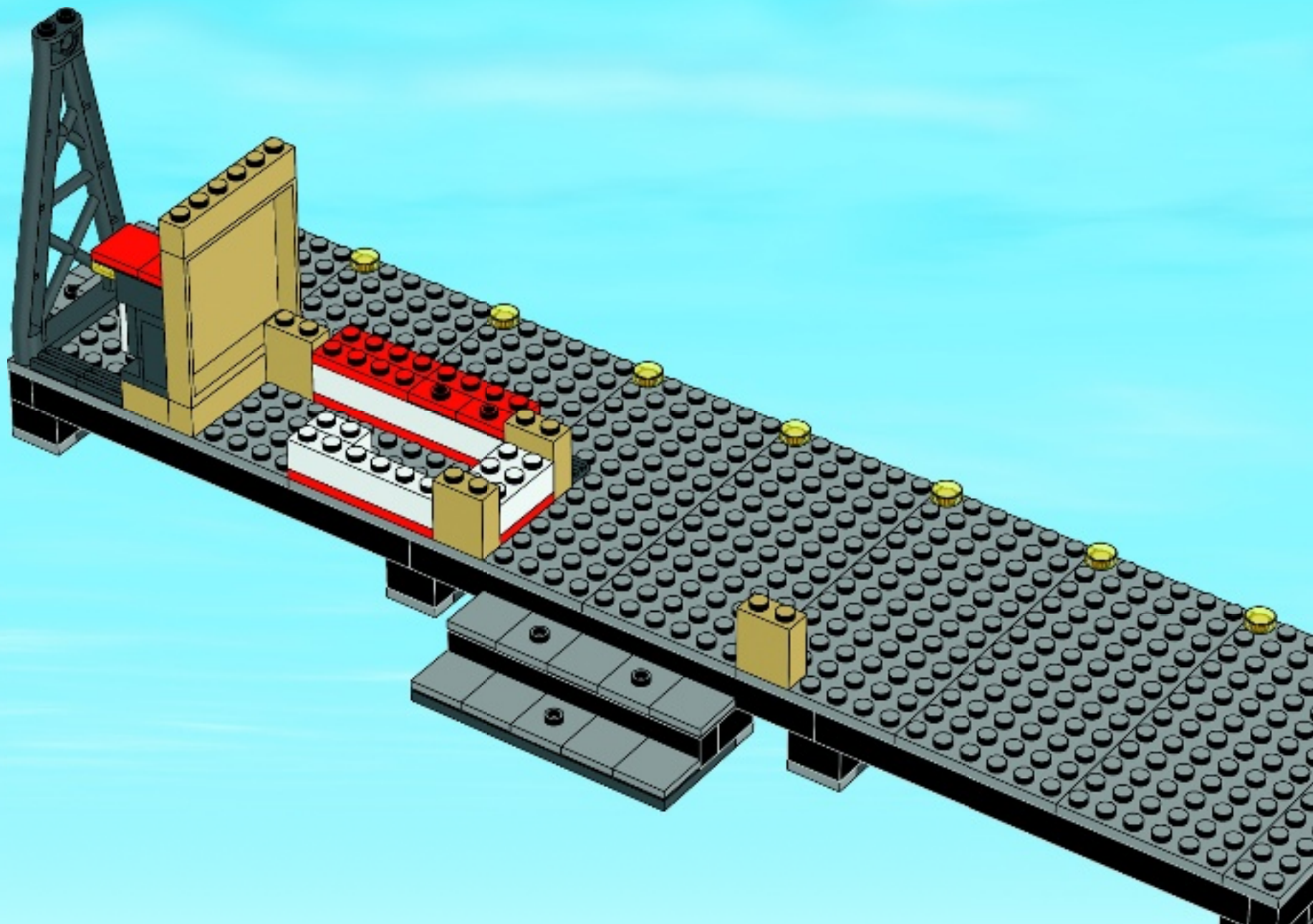

3x

32



1x  1x  1x 

33

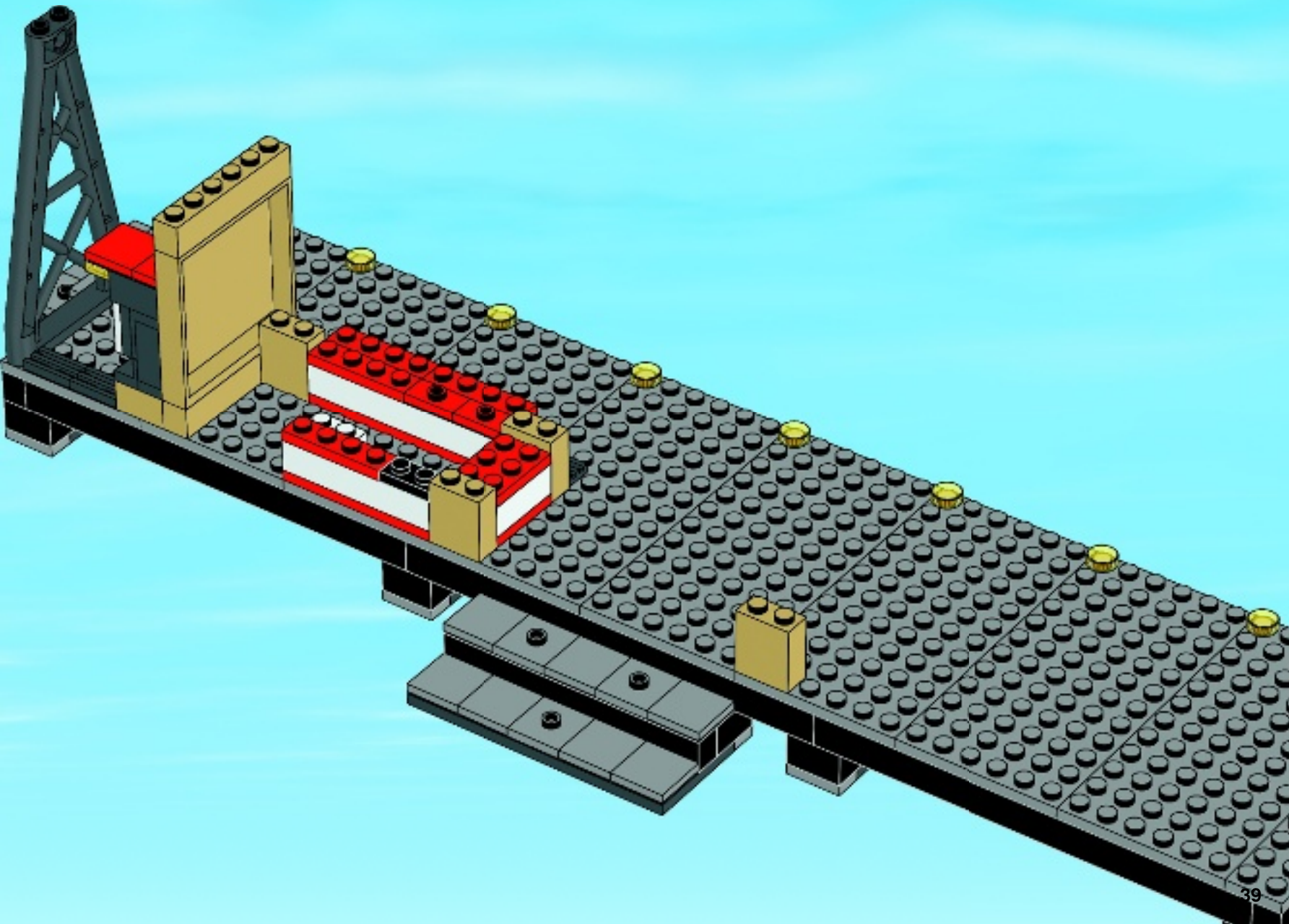



4x

34

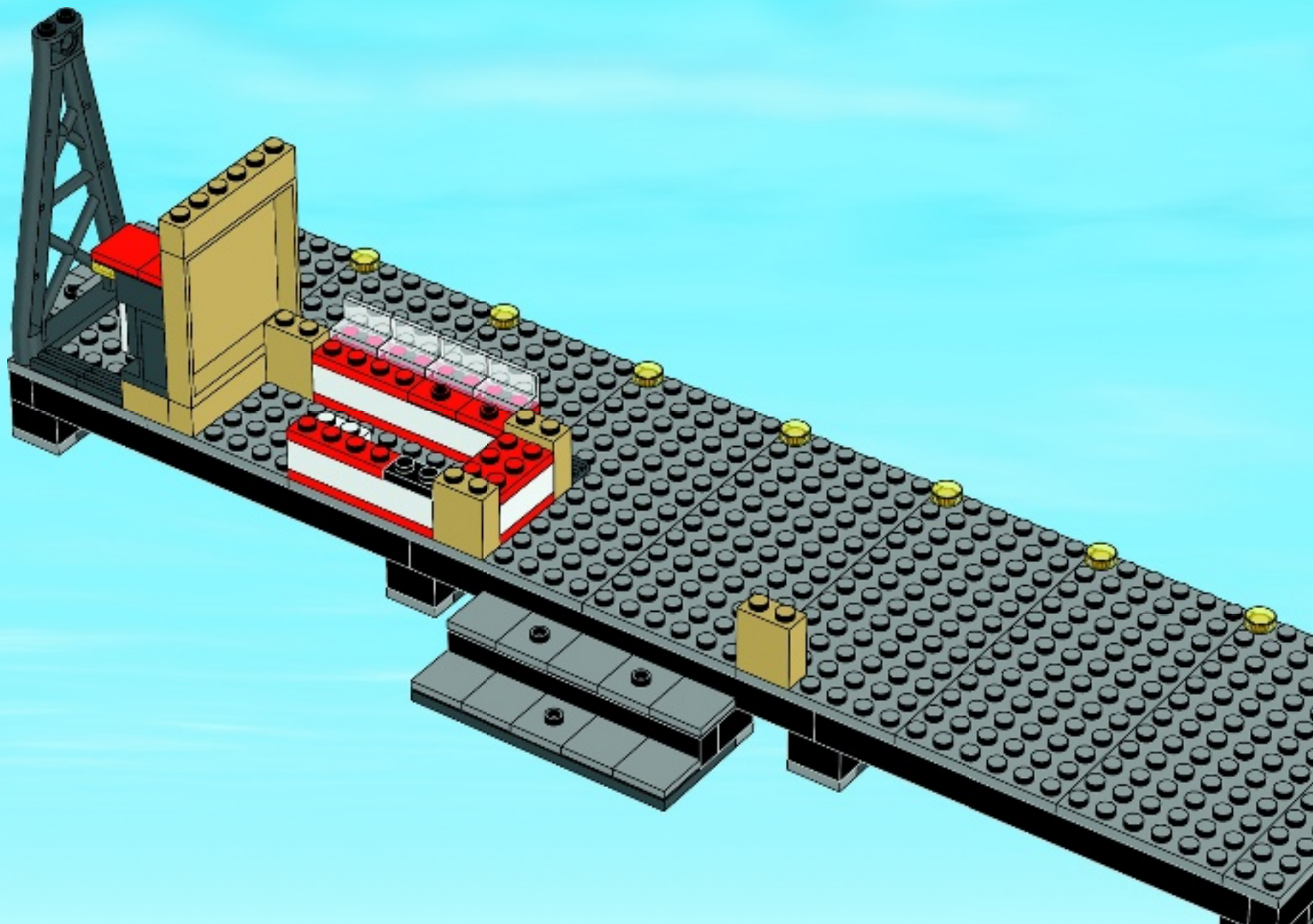

1x  1x  1x  1x 

35

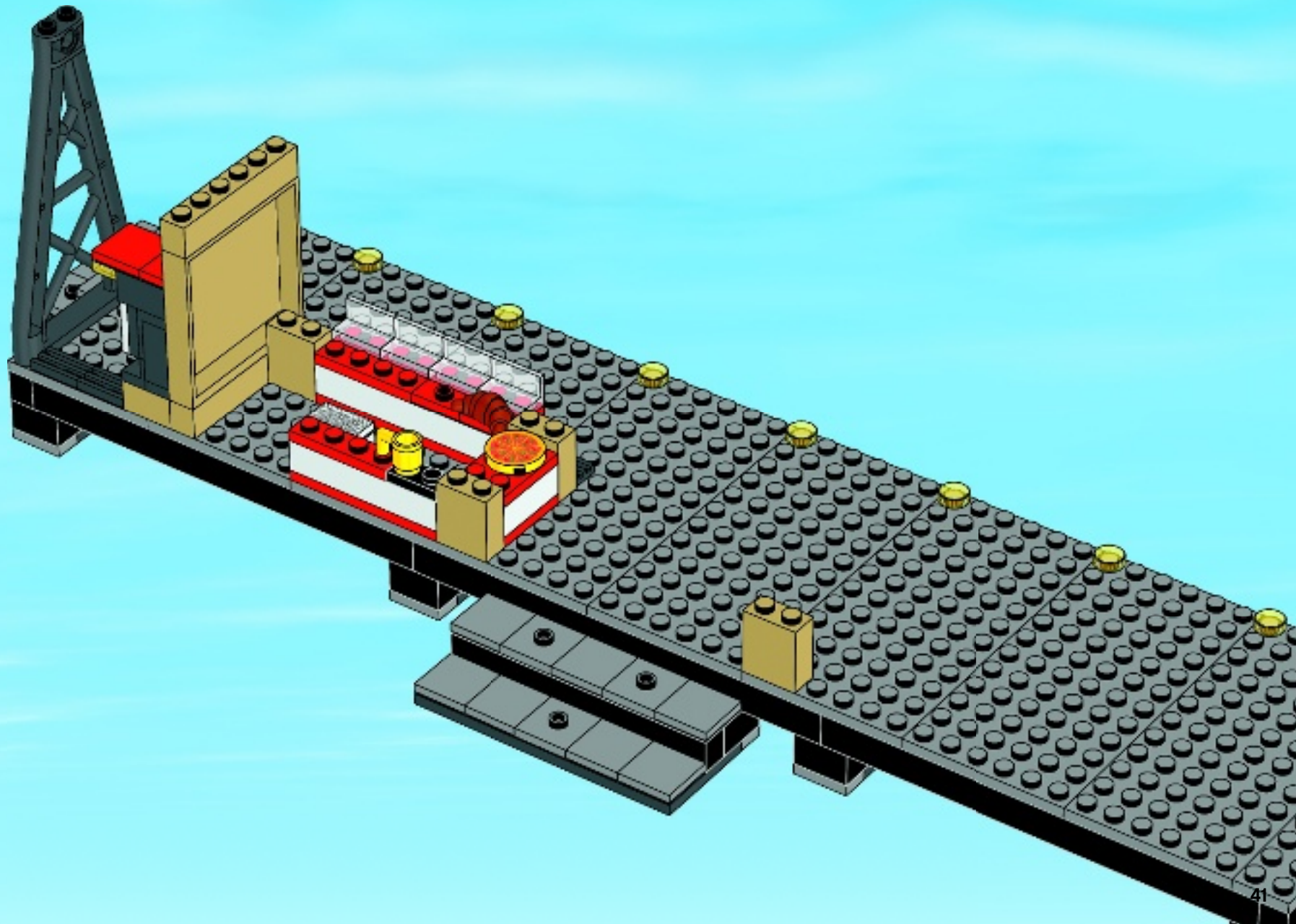



1x



1x



2x

36

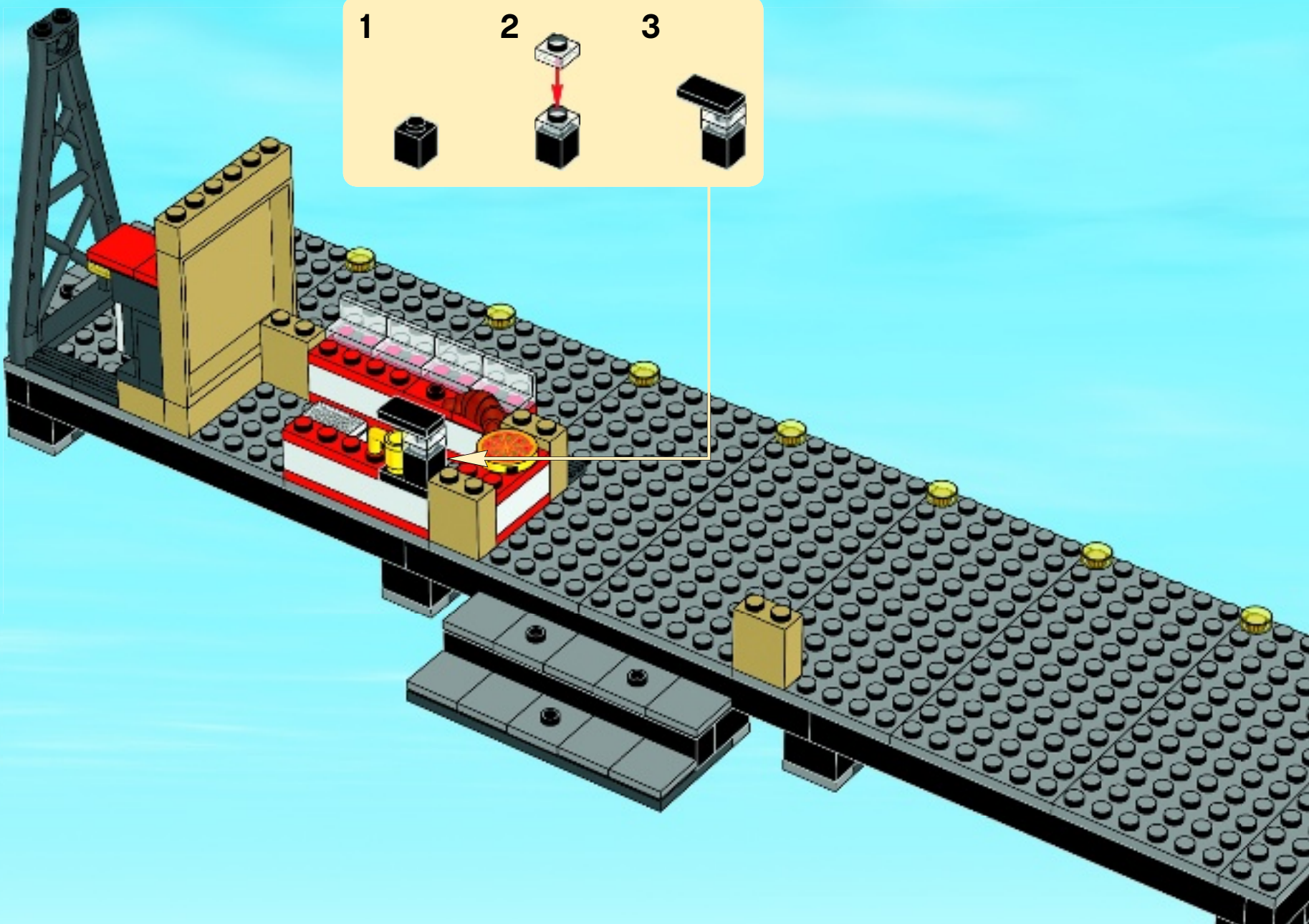

1

2

3



2x



2x



2x



2x

37

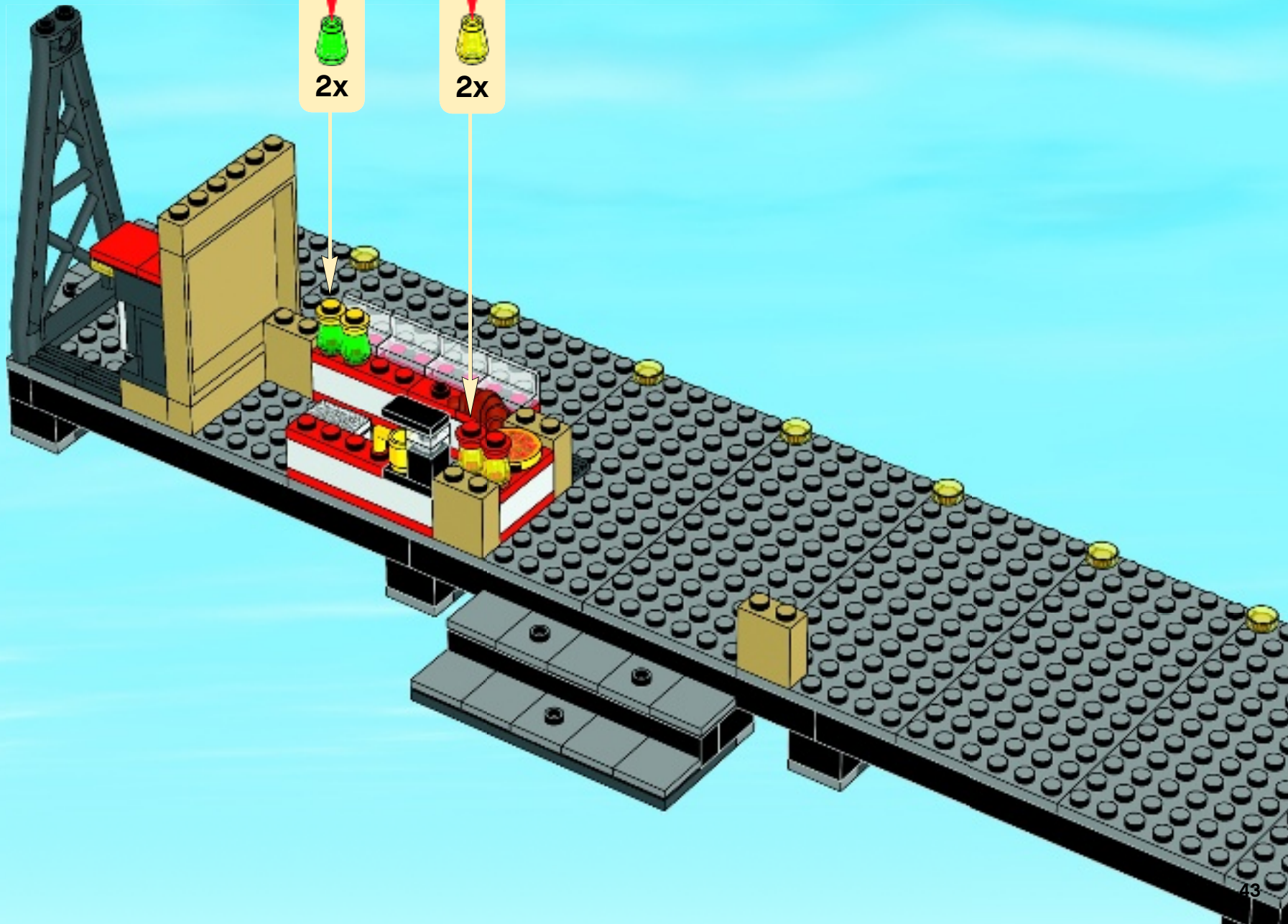



1x



1x

38

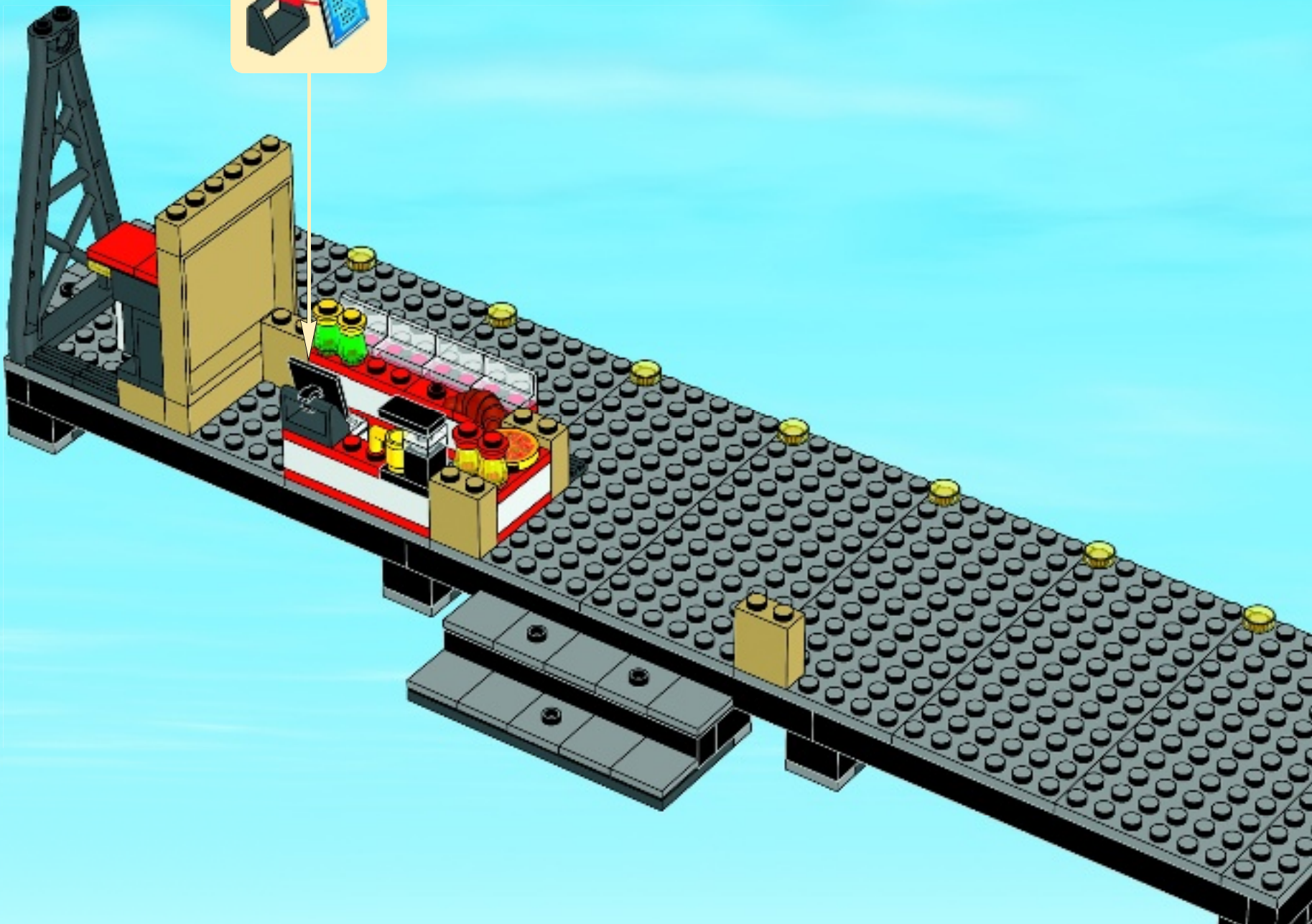



3x

39

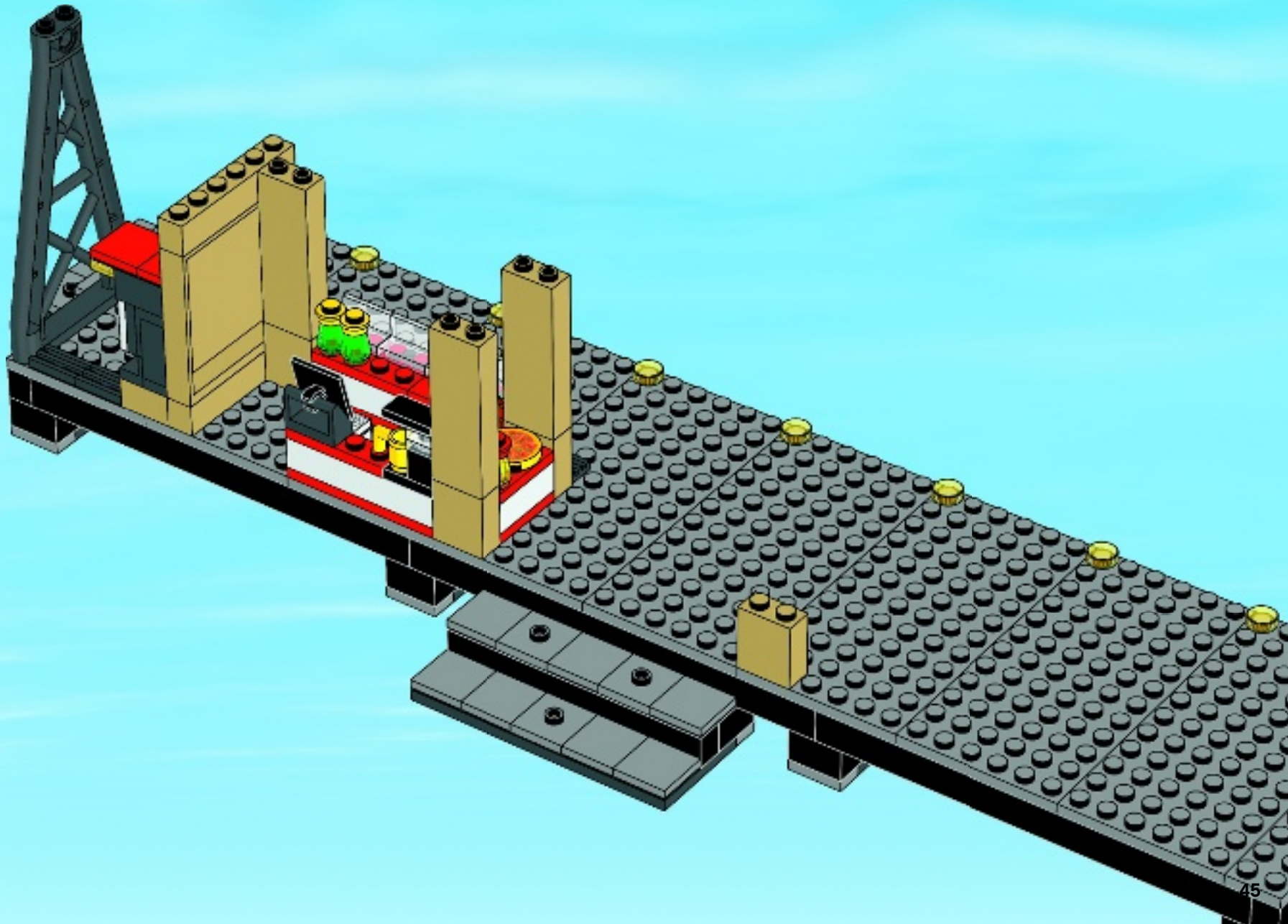

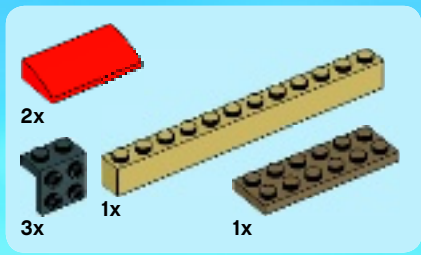

40

1

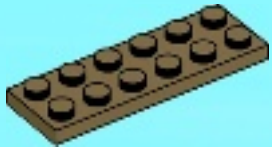

2

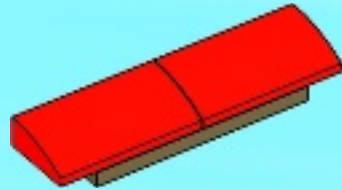

3

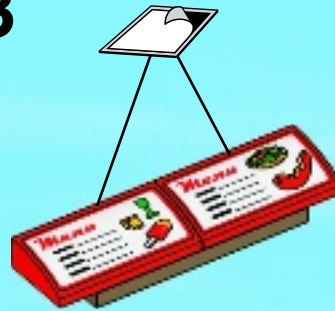

4

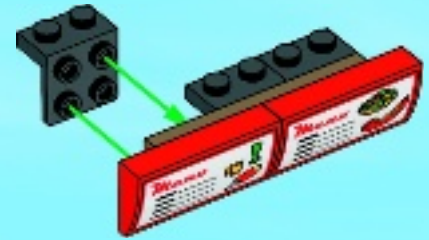

5

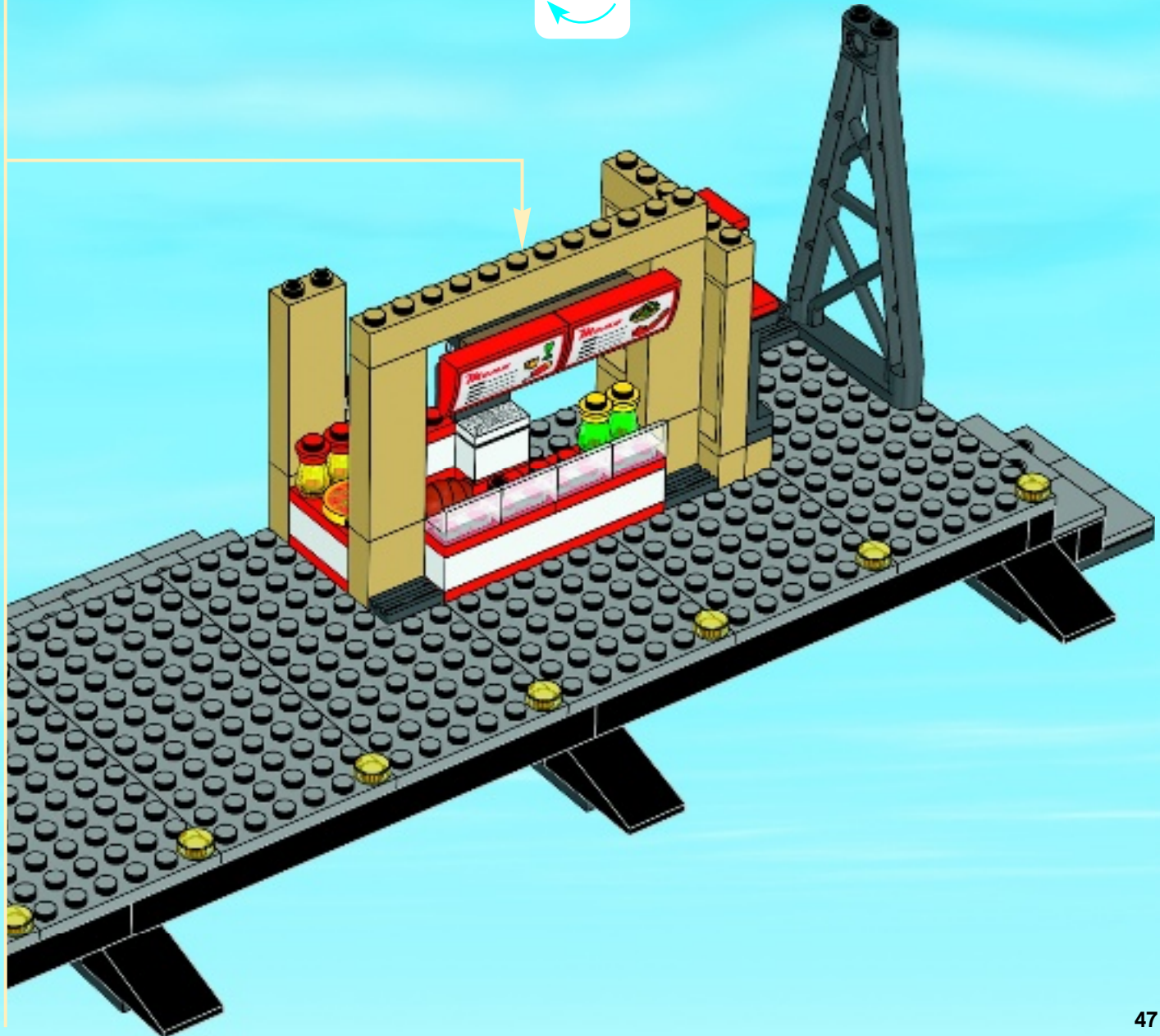



41

