



MONSTER FIGHTERS

9462



1

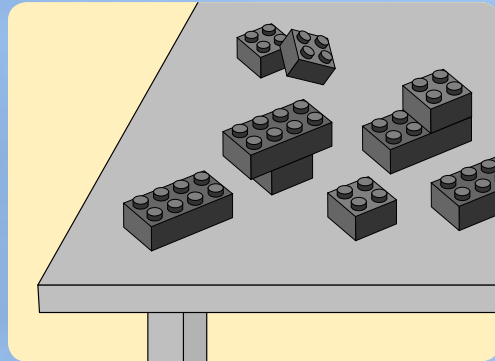
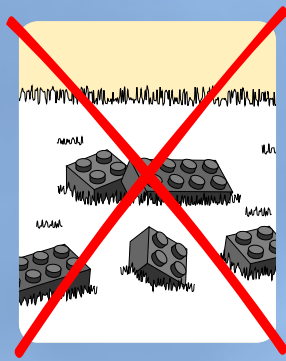

2

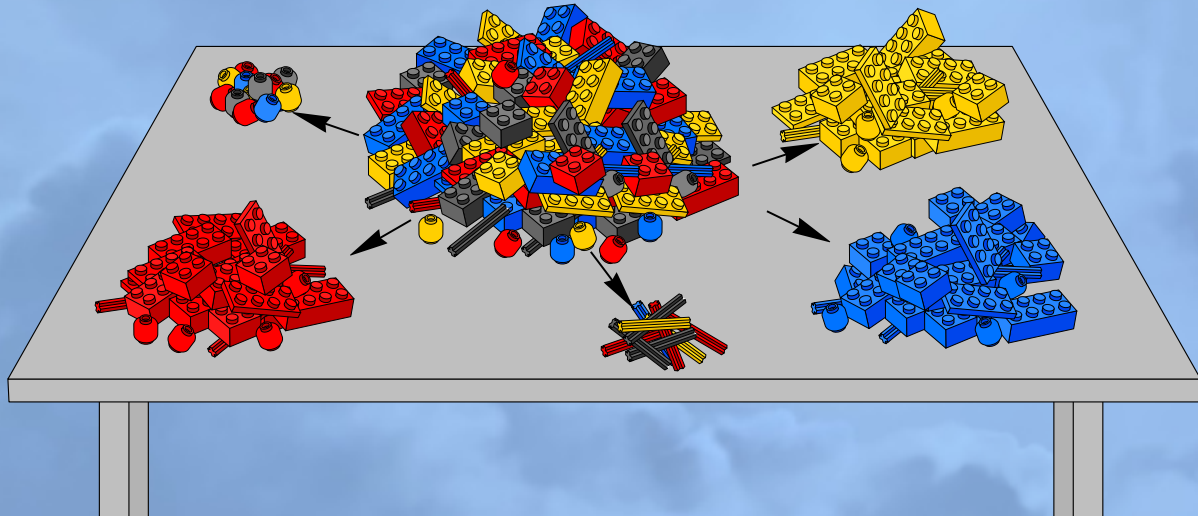

2

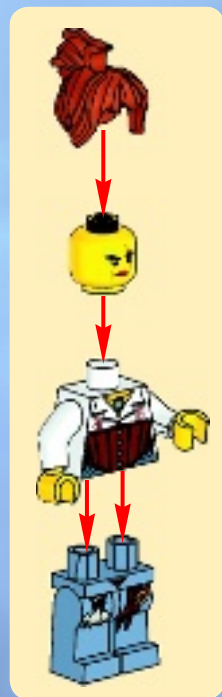



1x

1



1x

2



2x

3





1x

4



1x

5



2x



2x

6

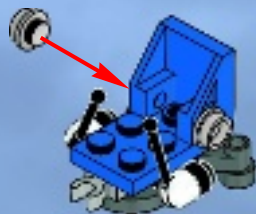



1x



1



2x

2



1x

3





2x

4

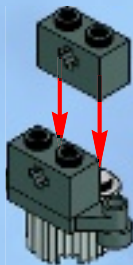

2x

5

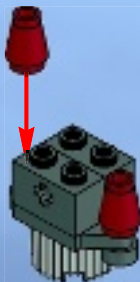

1x

6

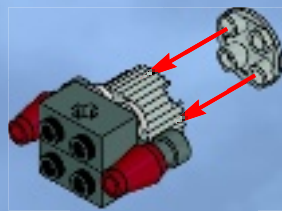



1x

7



8



1x



1x

8

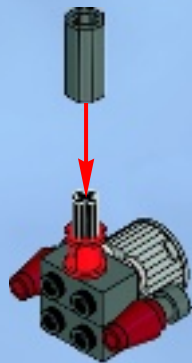

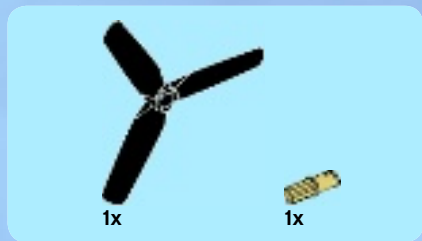

9

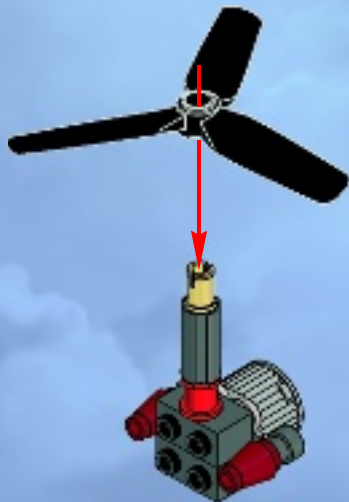

10

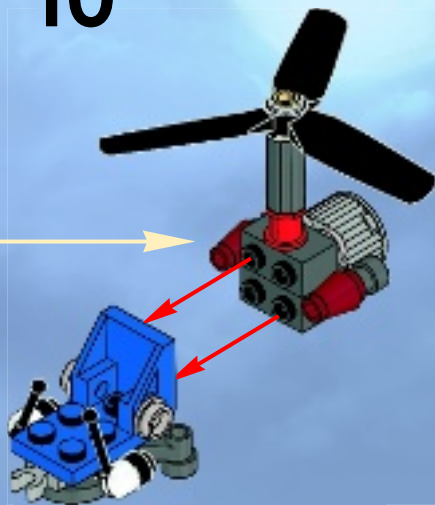



2x

11

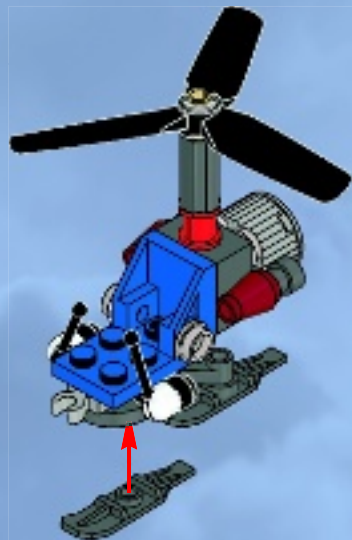



1x

1



1x

1x

2





2x

3

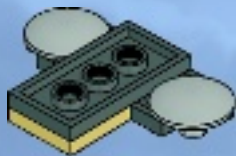

2x



1x

4





1x

5

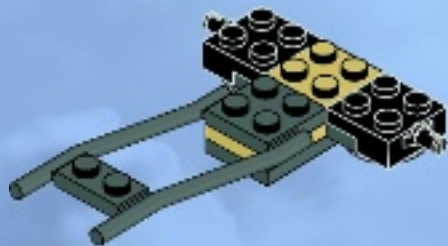

1x



2x

6

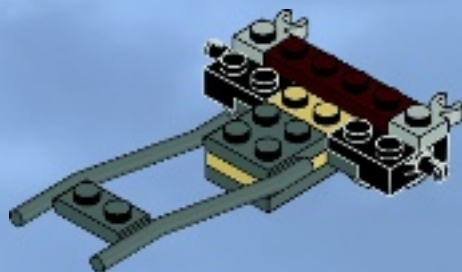



2x

7



2x

8





2x

9

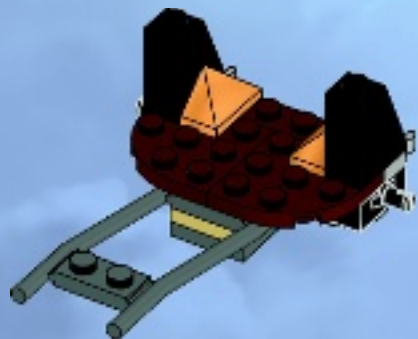

1x



1x

10

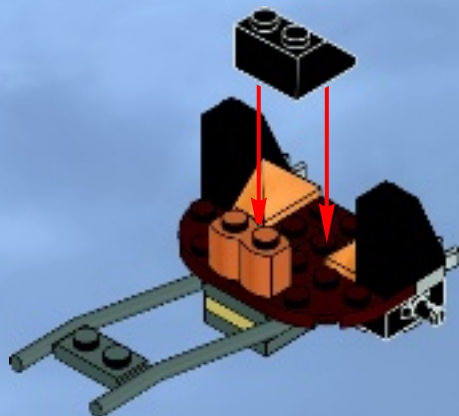



1x



2x

11

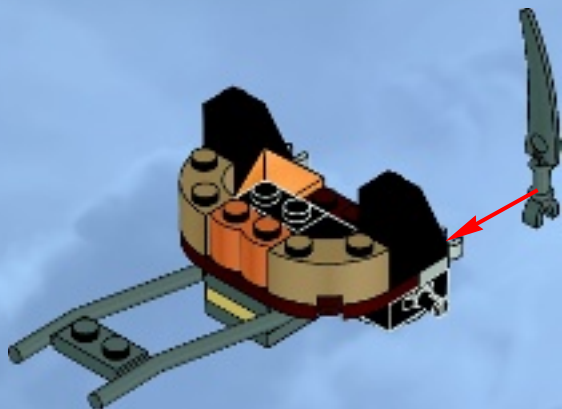

2x



2x

12

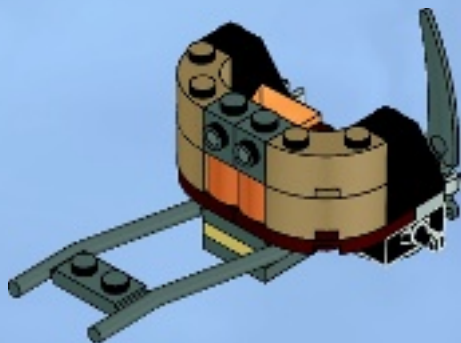



2x



2x

13

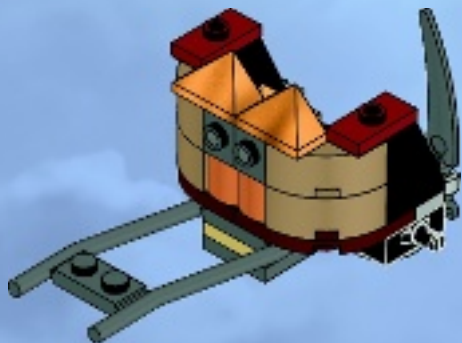

2x



2x

14

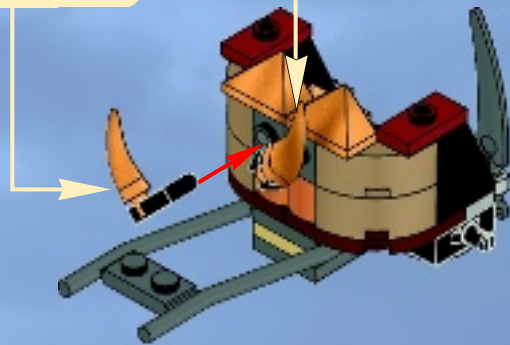
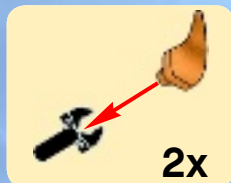



2x



4x

15



2x

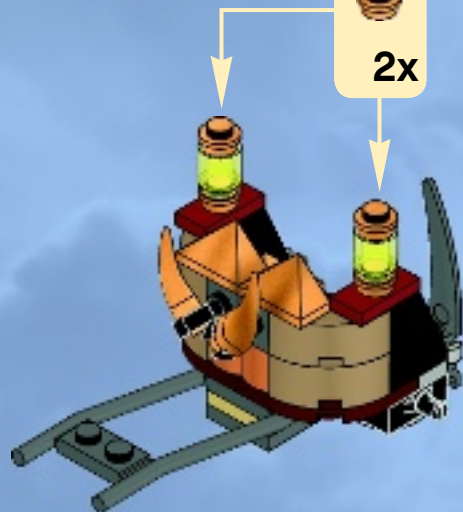

2x

16

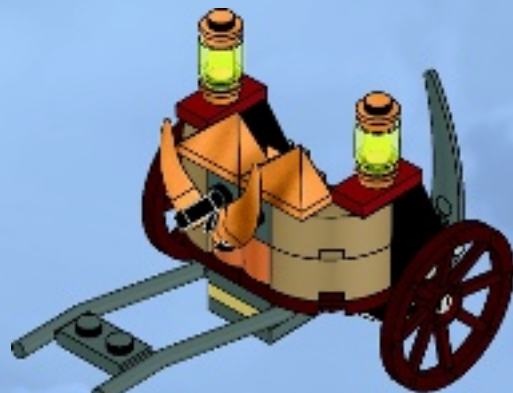



1x

17

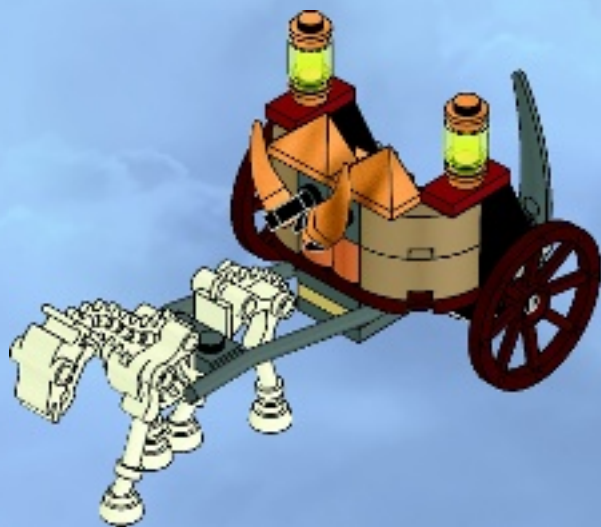



2x



2x

18

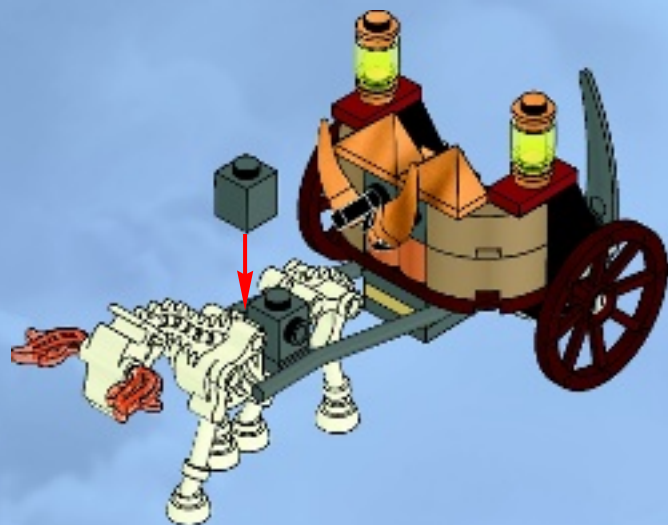



2x



1x

19

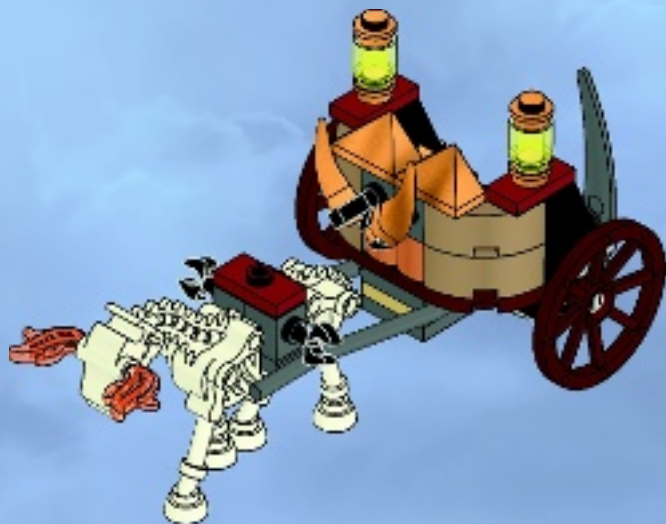



2x

20





1x



1x

21

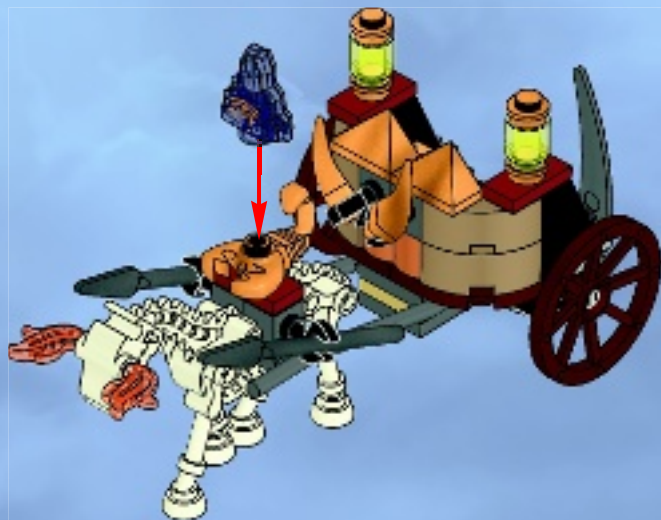





Customer Service
Kundenservice
Service Consommateurs
Servicio Al Consumidor

www.lego.com/service or dial



: 00800 5346 5555

: 1-800-422-5346



MONSTER FIGHTERS



9461



9462



9463



9464



9467



9466



9468



3

www.LEGOclub.com/Max

LEGO club™

FREE*! GRATIS! GRATUIT!

*Paid subscription in Australia and New Zealand.
*Abonnement payant en Australie et Nouvelle-Zélande.

©2012 The LEGO Group.





WIN!

Go to www.LEGOsurvey.com/product to fill out a survey for a chance to win a cool LEGO® Product.

No purchase necessary.

Open to all residents where not prohibited.



www.LEGOsurvey.com/product

GEWINNE!

Nimm an der Umfrage auf www.LEGOsurvey.com/product teil und hab die Chance ein cooles LEGO® Produkt zu gewinnen!

Die Teilnahme am Gewinnspiel führt zu keinerlei Kaufverpflichtungen. Teilnahme in allen nicht ausgeschlossenen Ländern möglich.

WIN!

Ga naar www.LEGOsurvey.com/product, vul een enquêteformulier in en maak kans op een cool LEGO® product.

Geen aankoopverplichting. Iedereen mag deelnemen, uitgezonderd ingezetenden van landen waar een enquêteverbod geldt.

GAGNE !

Visite www.LEGOsurvey.com/product pour répondre à un questionnaire et avoir une chance de gagner un produit LEGO® très cool !

Aucune obligation d'achat. Ouvert à tous les résidents des pays autorisés.

当てよう!

www.LEGOsurvey.com/product にアクセスして、アンケートにご記入ください。当選者にはレゴ製品を差し上げます。

お買い上げの必要はありません。禁止されていない限り、すべての皆様にご利用いただけます。



www.LEGO.com

6032885 / 6032886

LEGO and the LEGO logo are trademarks of the/son des marques de commerce de/son marcas registradas de LEGO Group. ©2012 The LEGO Group.