



# STAR WARS



75019



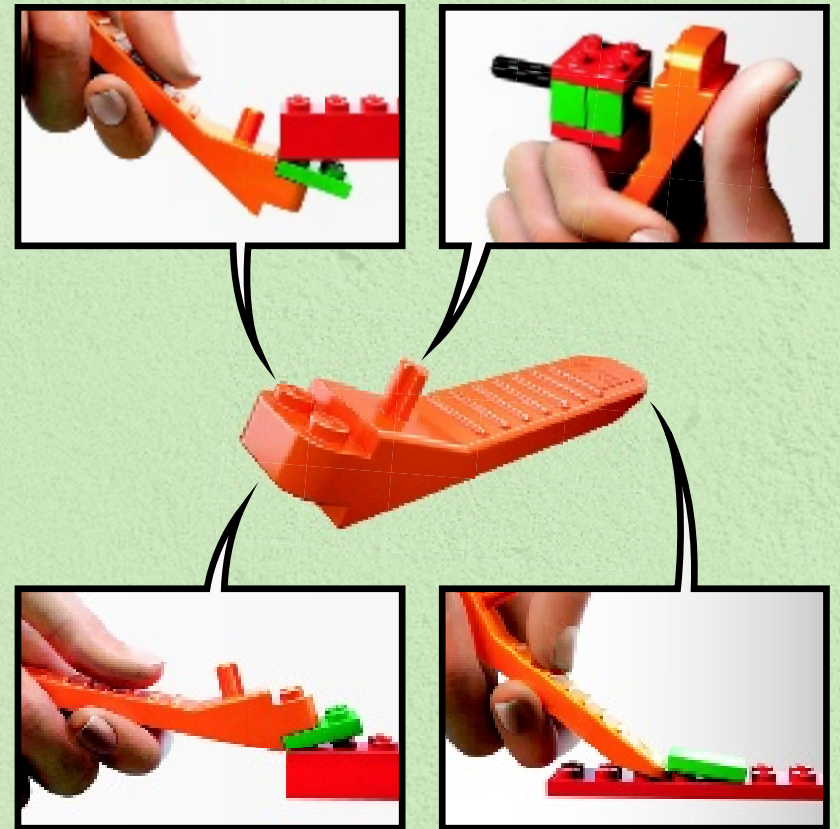

[LEGO.com/brickseparator](https://LEGO.com/brickseparator)

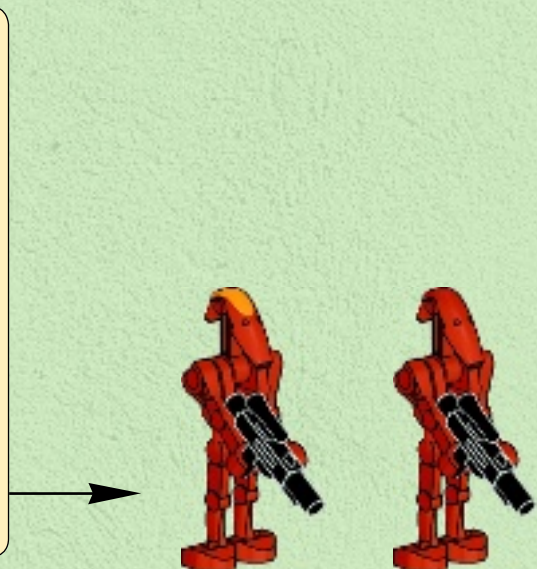
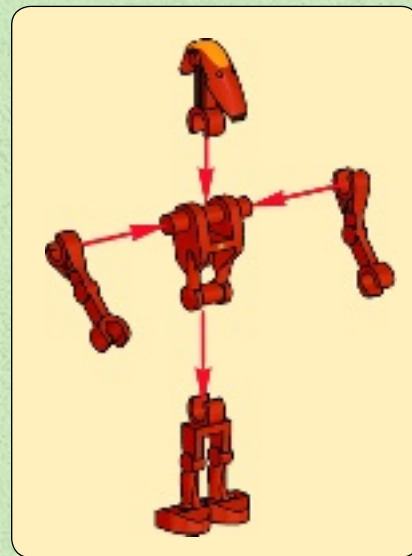
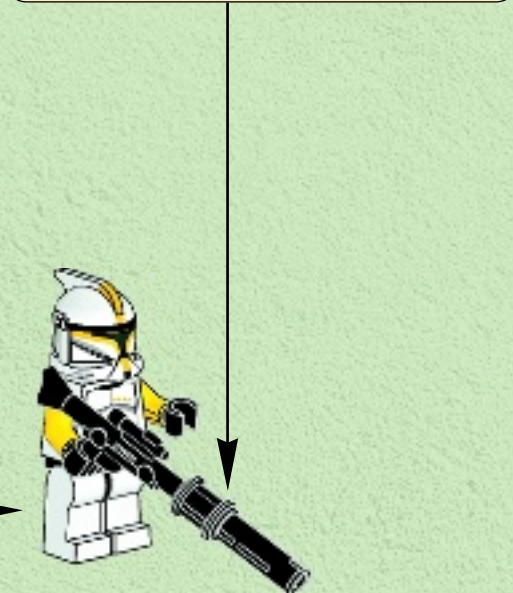
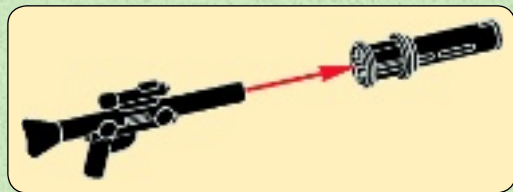
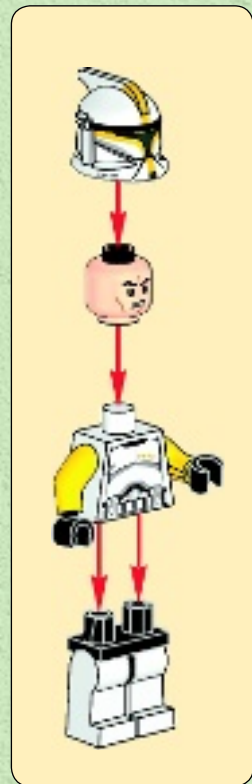
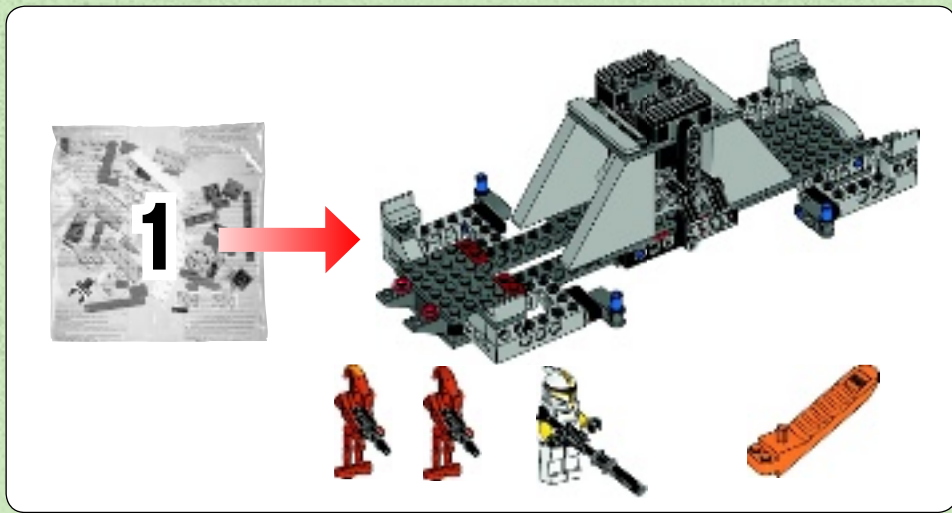

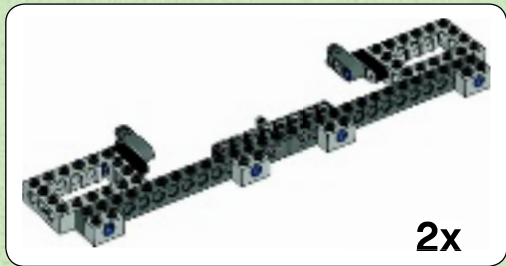
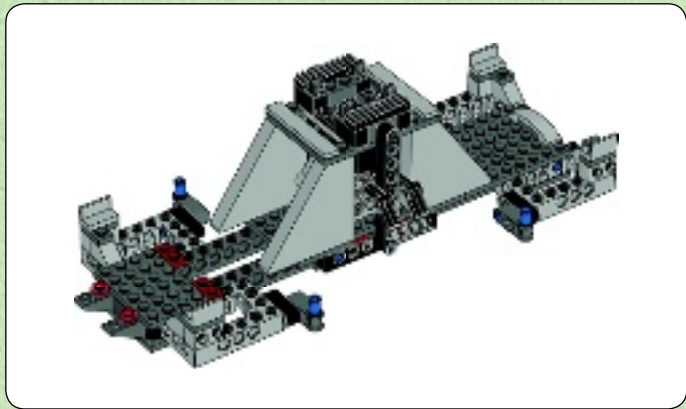

1



2

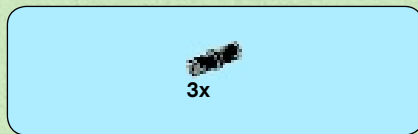
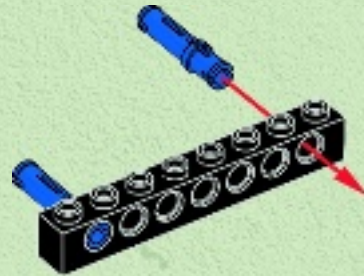

3



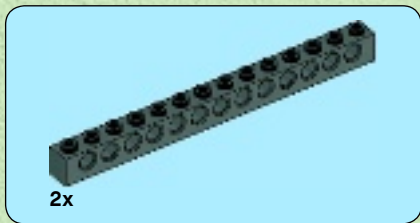

4

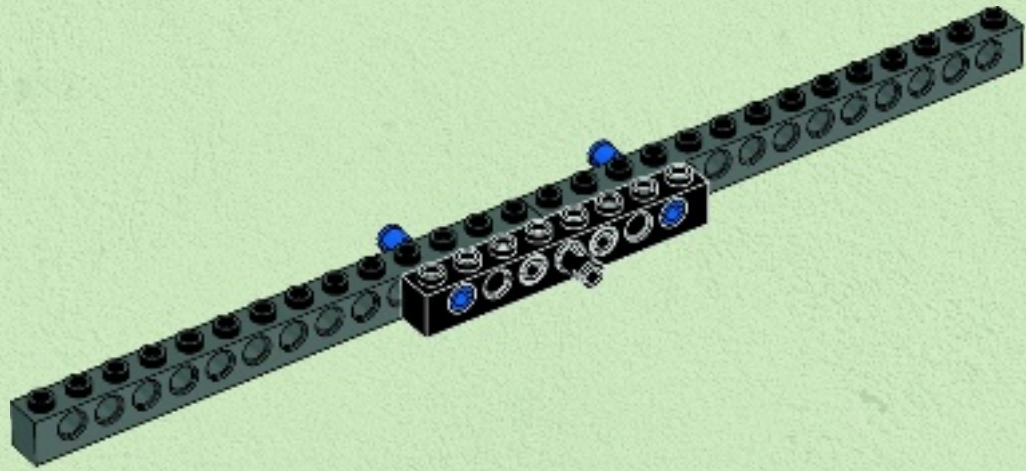

5

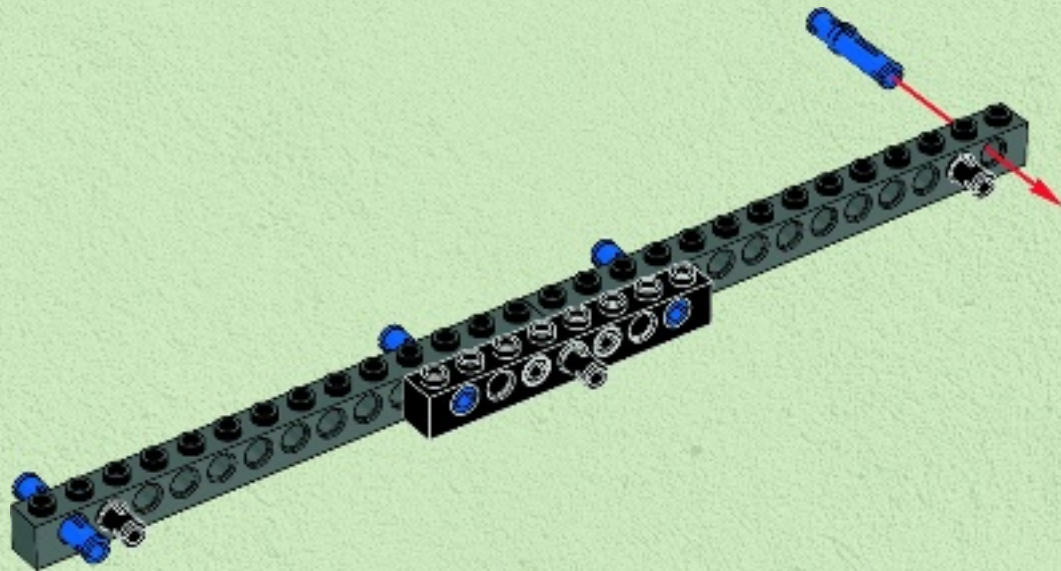



4x

6

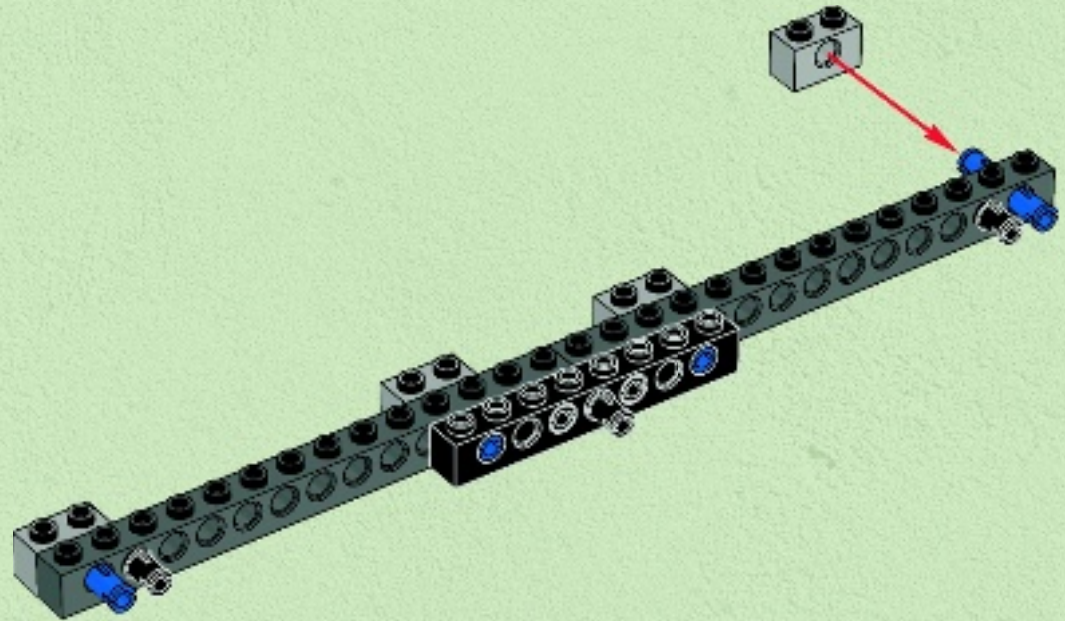

2x

7

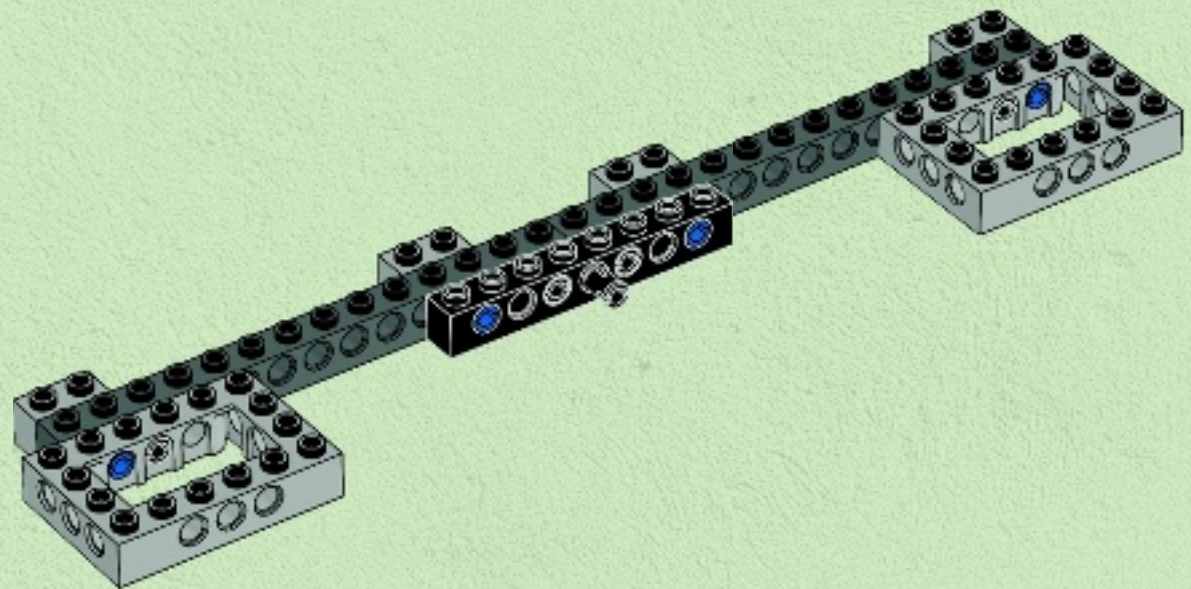

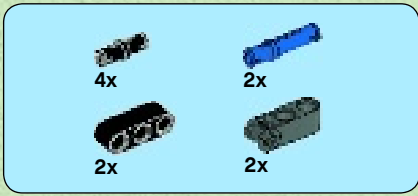

8

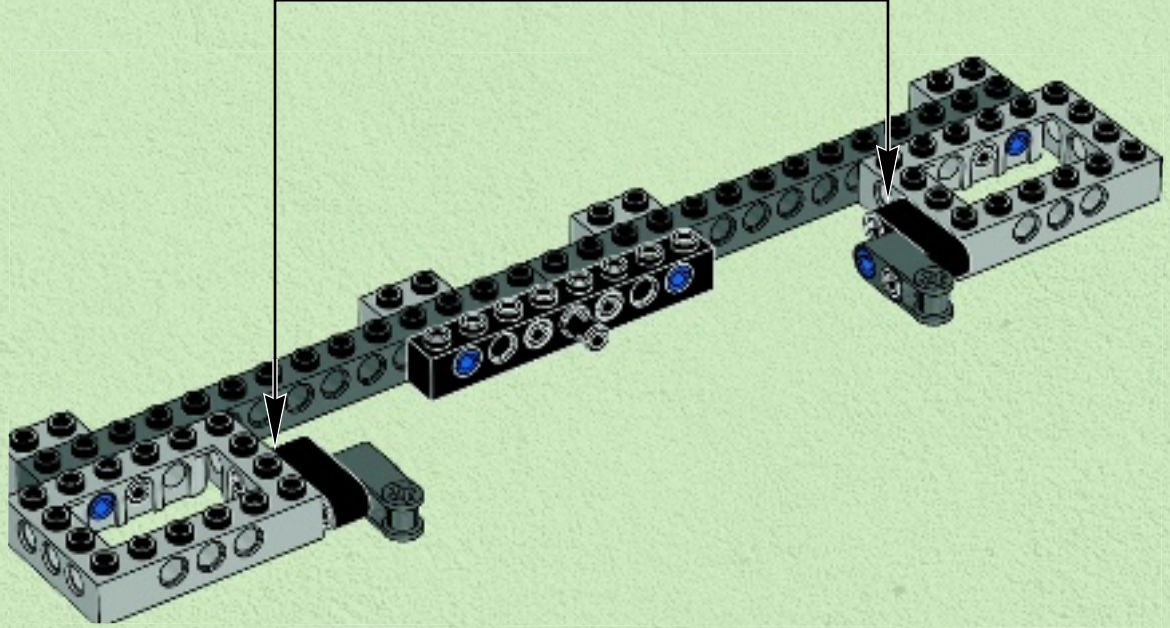
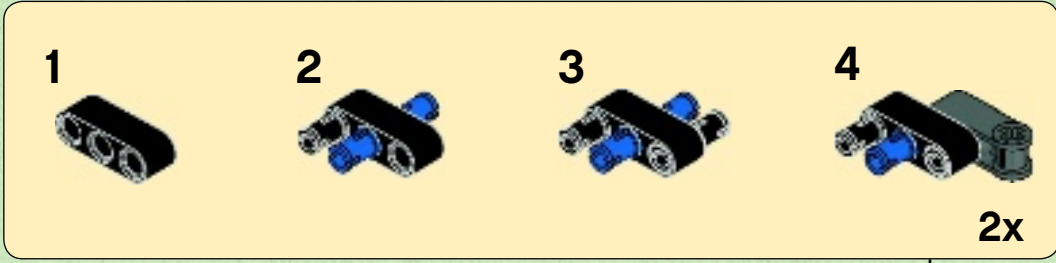

2x



9

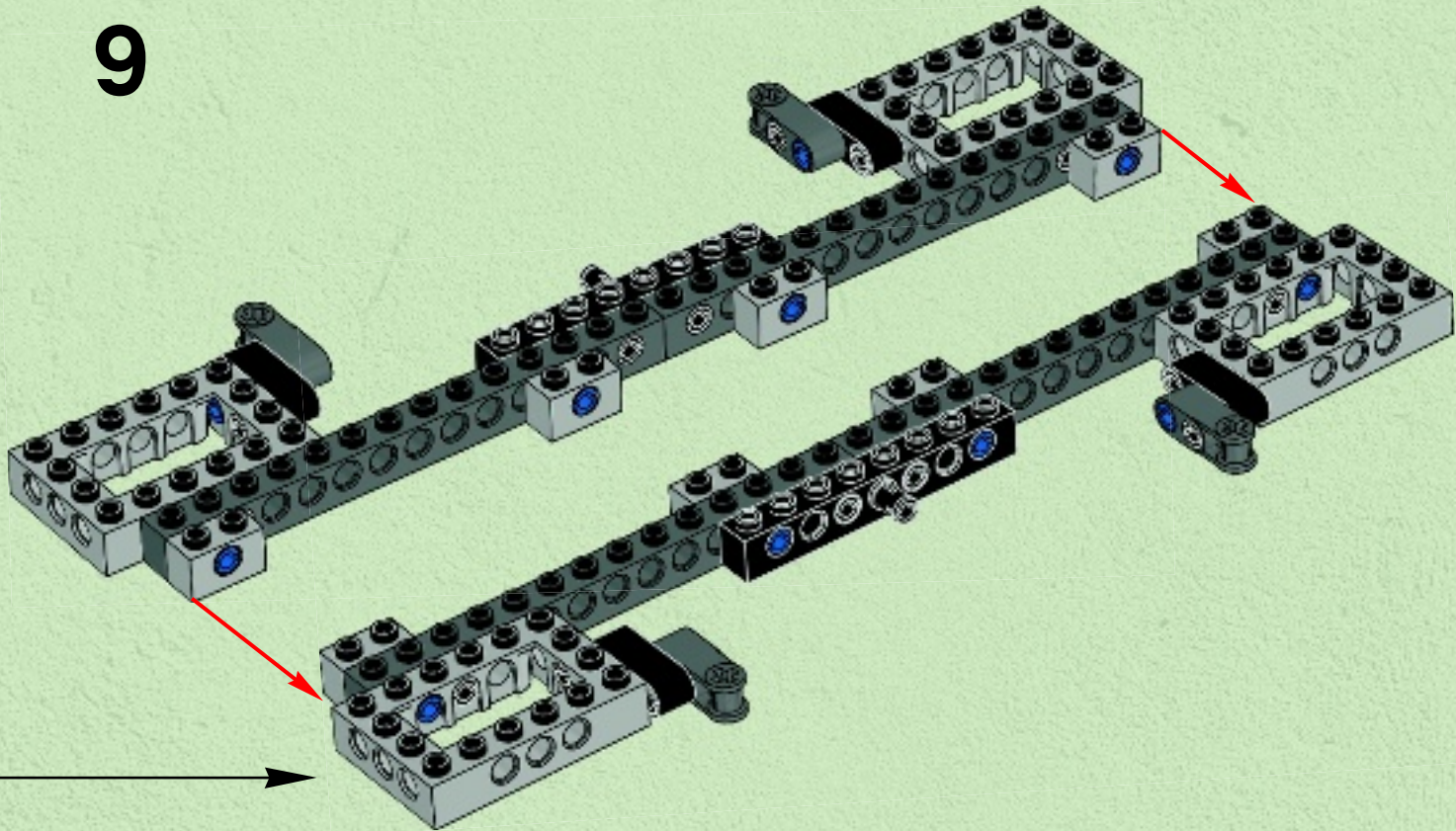





# 10

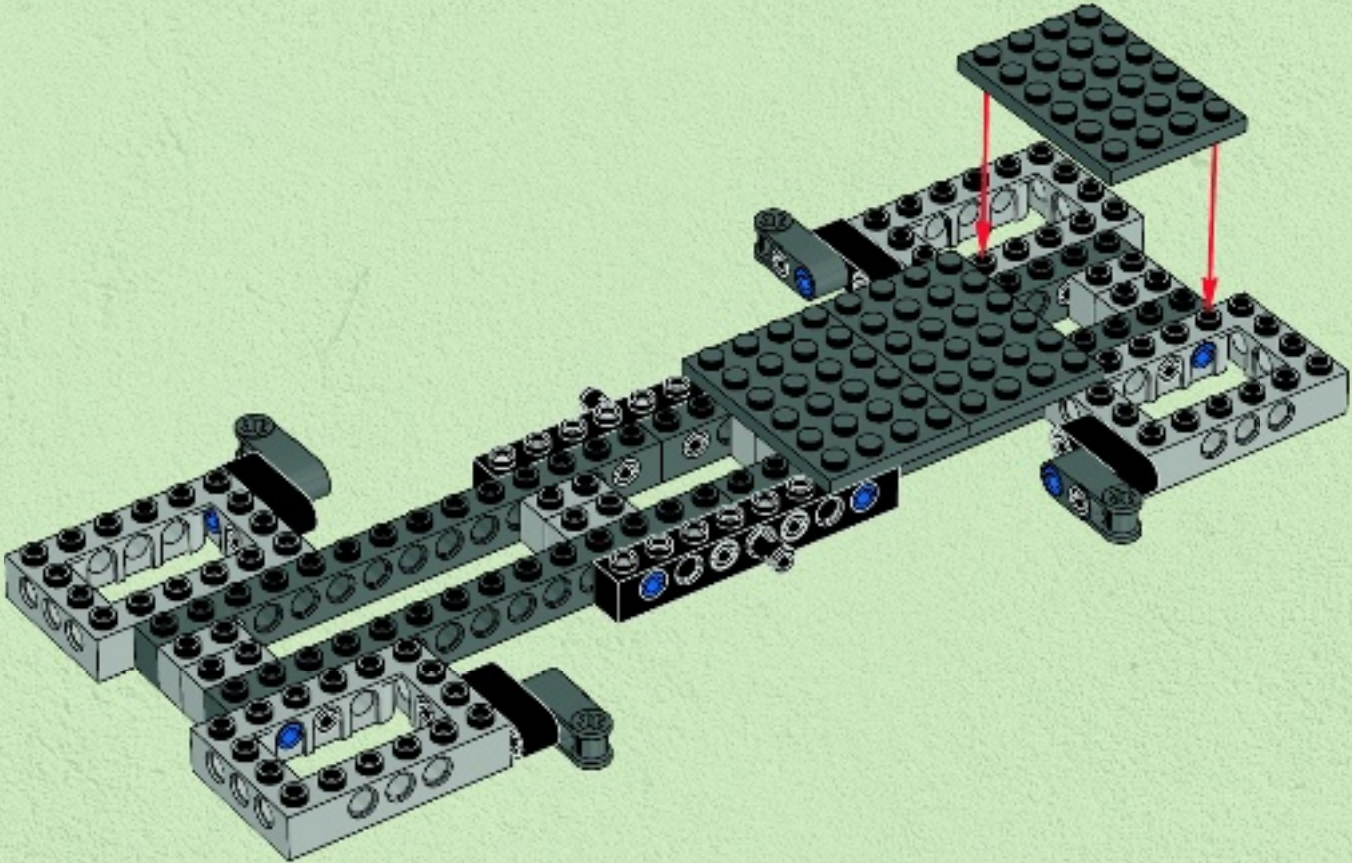

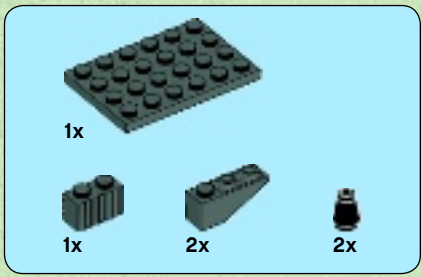

# 11

1

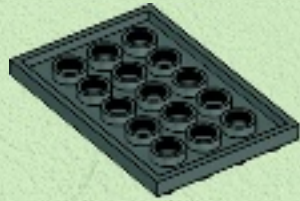

2



3



4

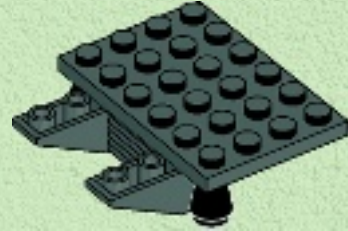
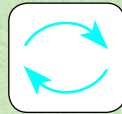

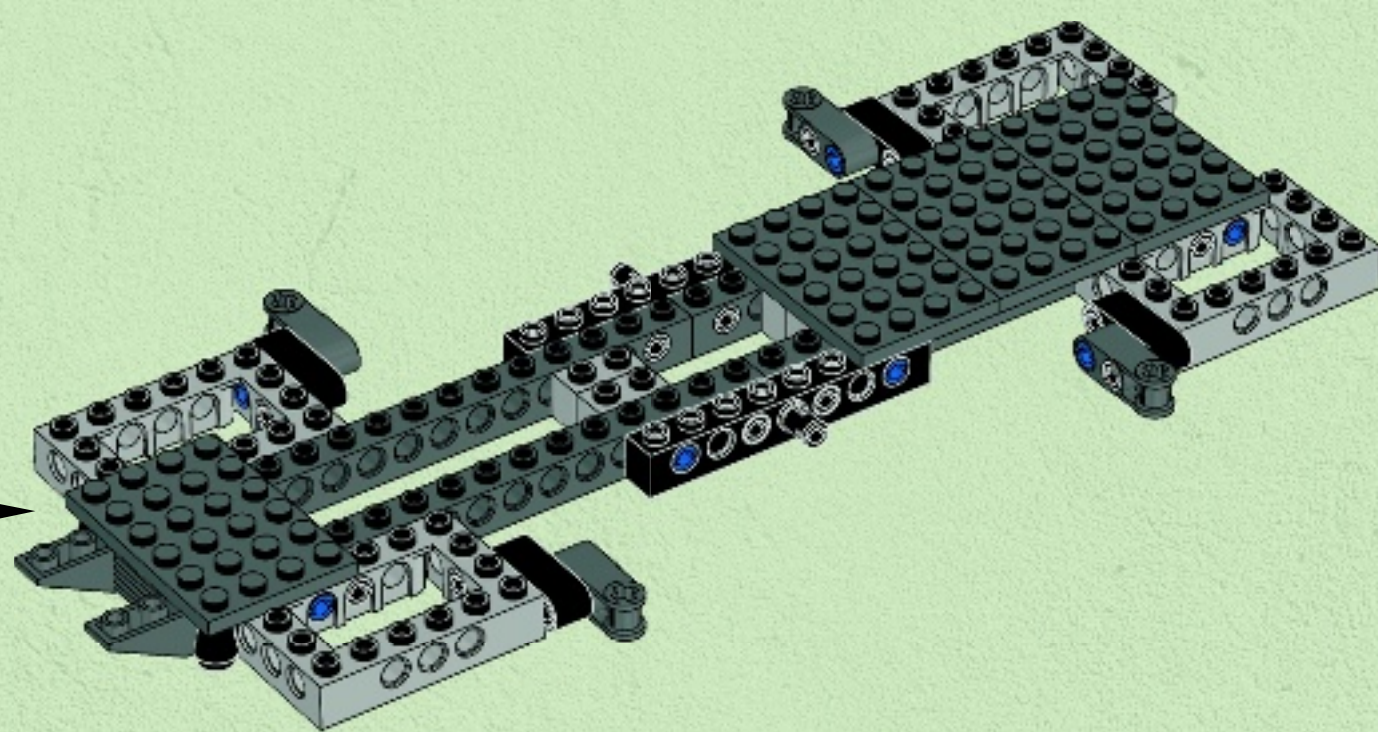

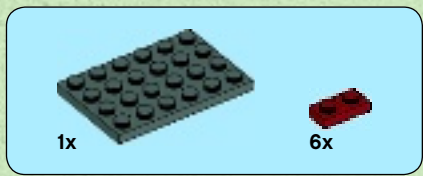

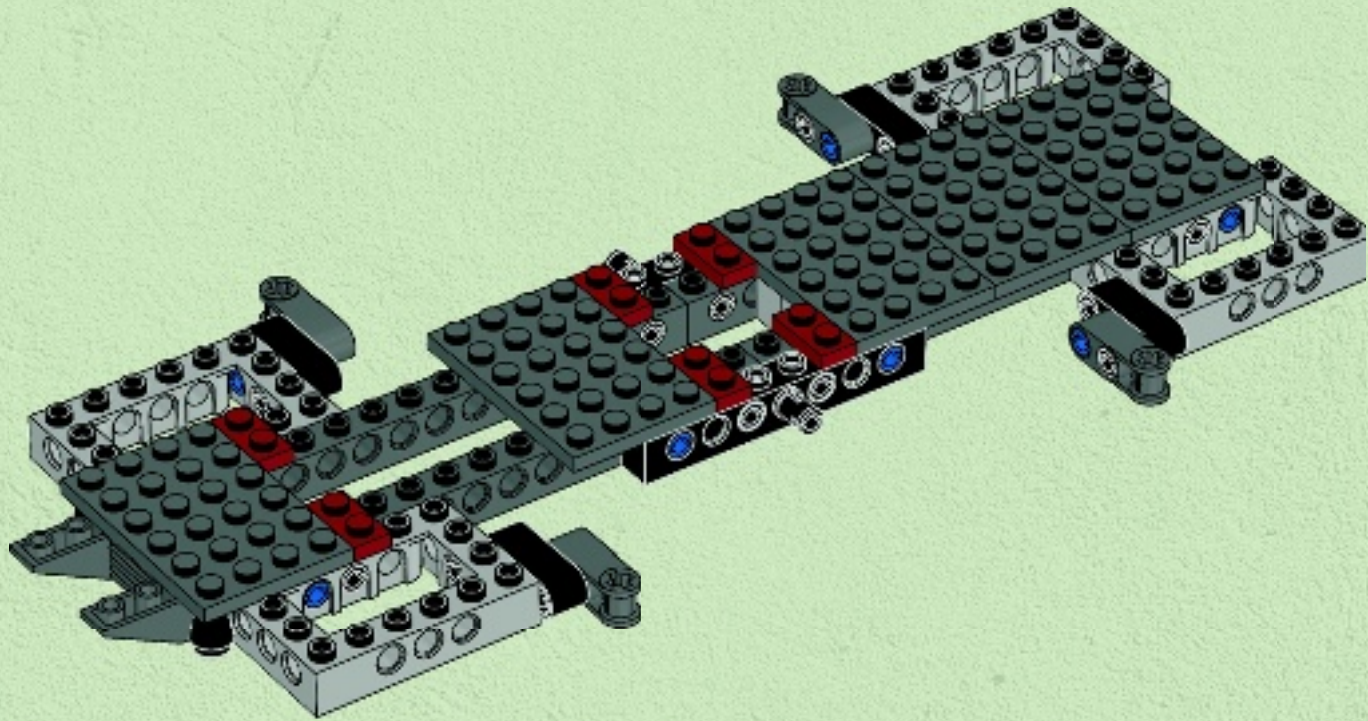

12

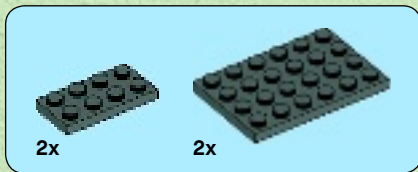

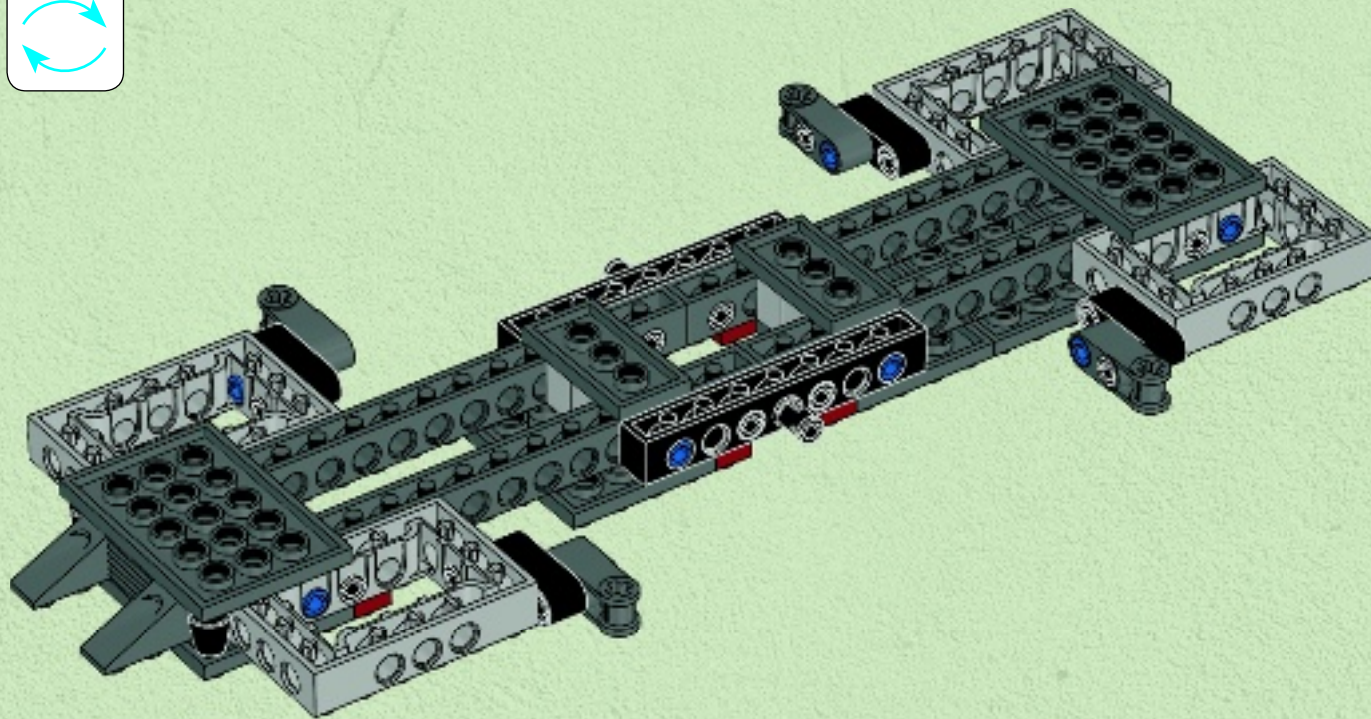
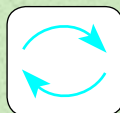

13



2x  4x 

# 14

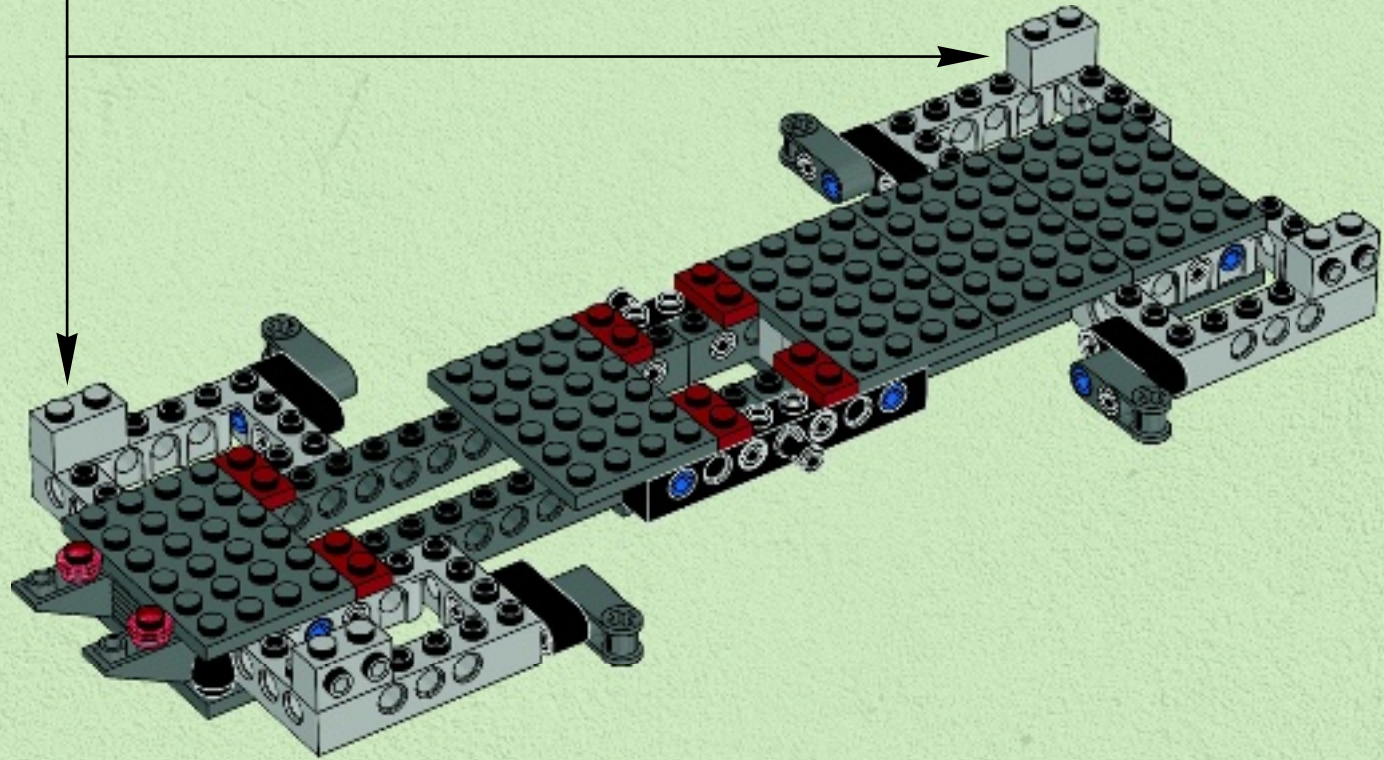
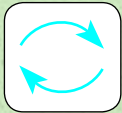

4x  1x 

15

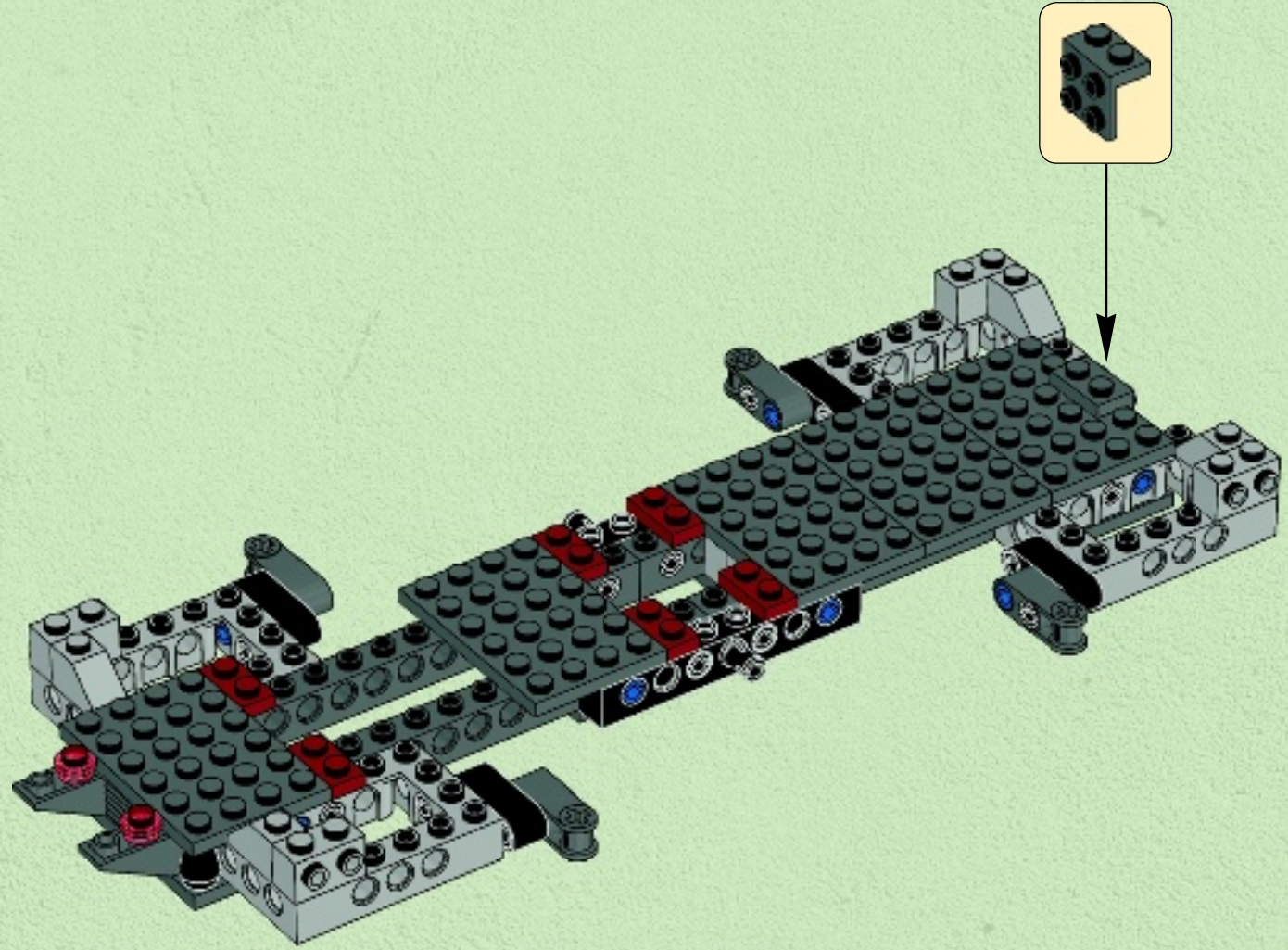



4x



1x

# 16

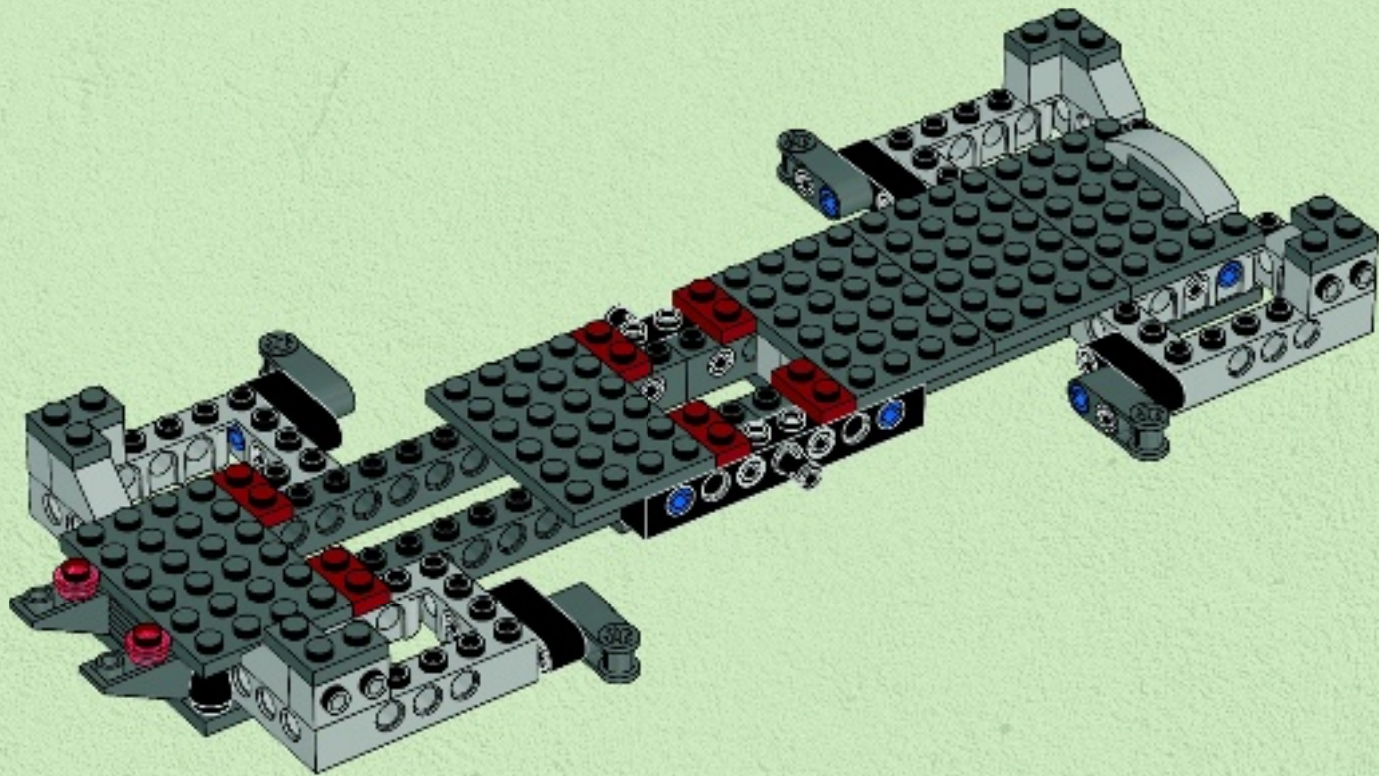



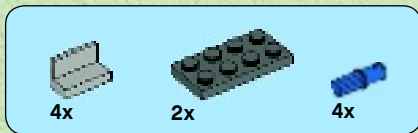

17

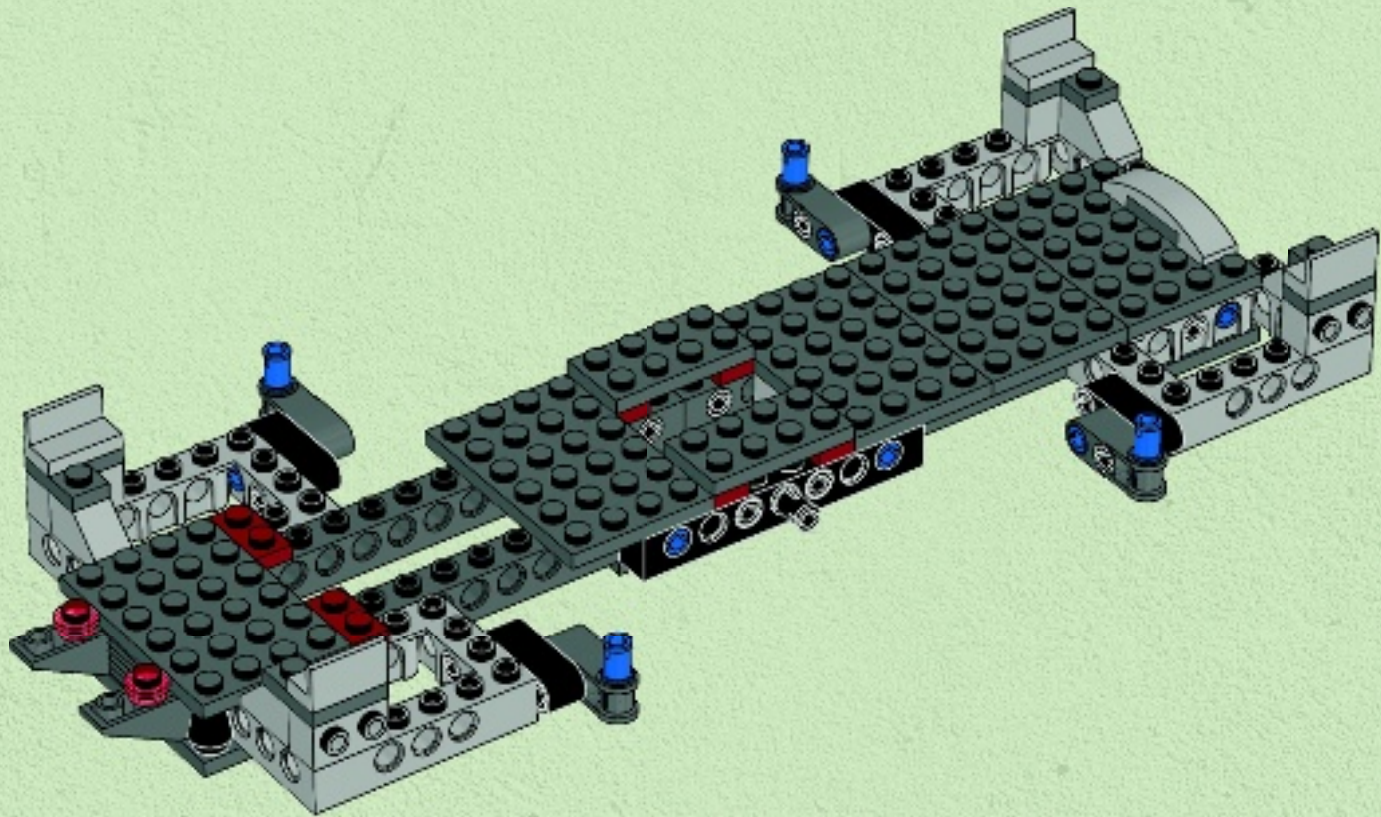

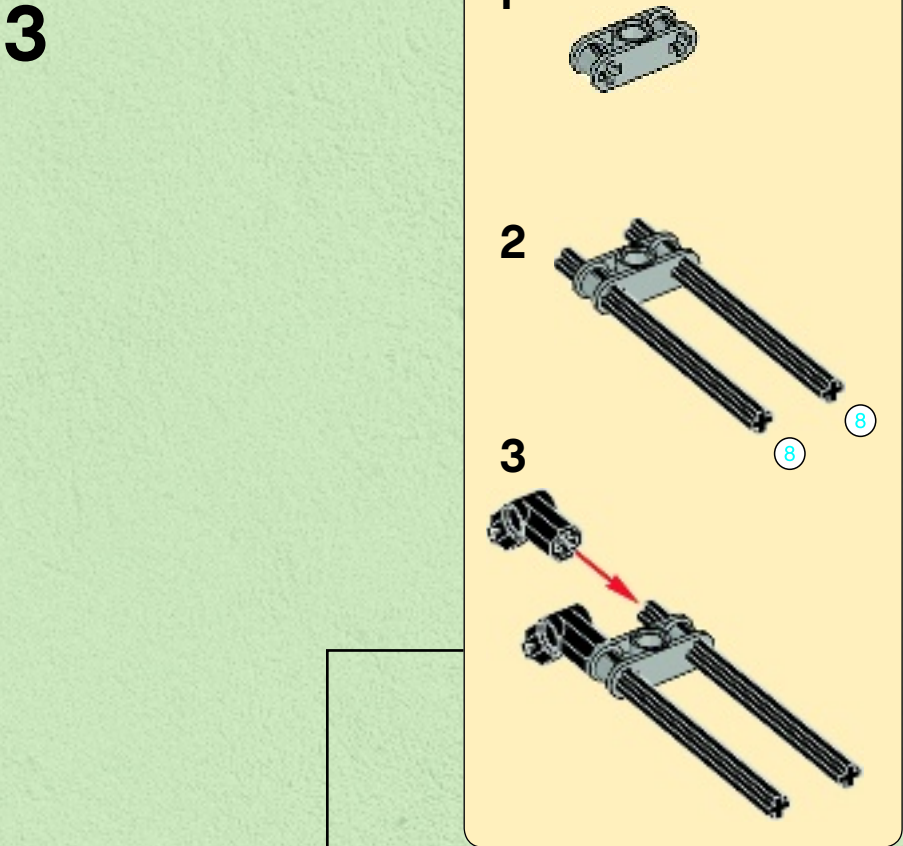
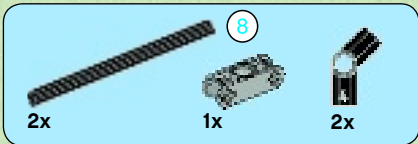
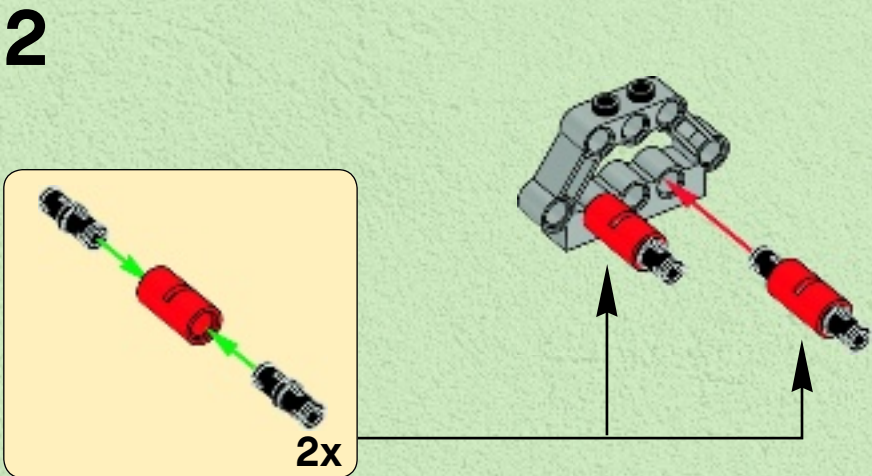
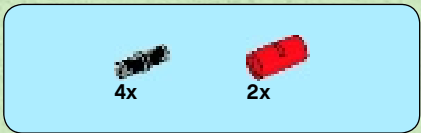
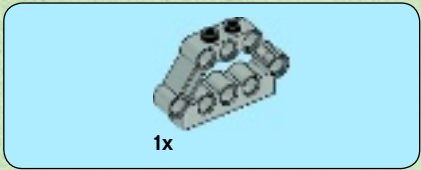



2x

4

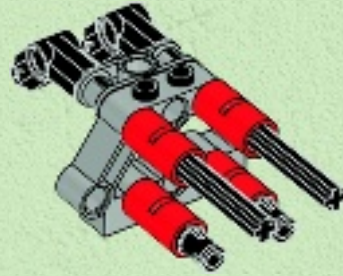

1x

5

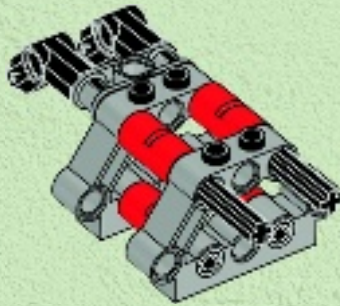

1x

6

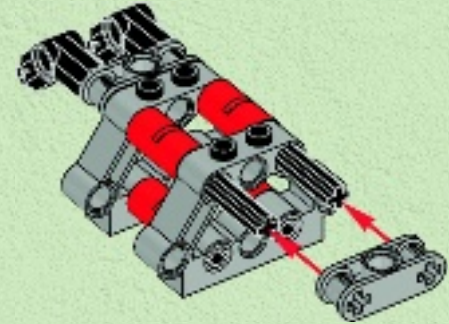

2x



2x

7

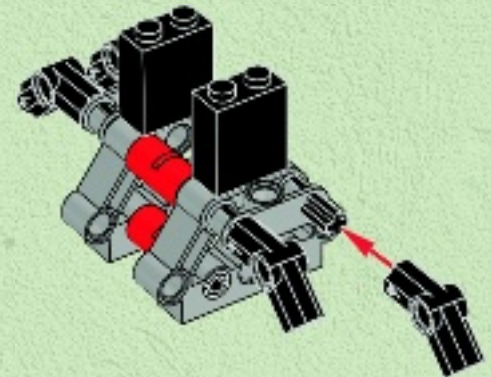

18

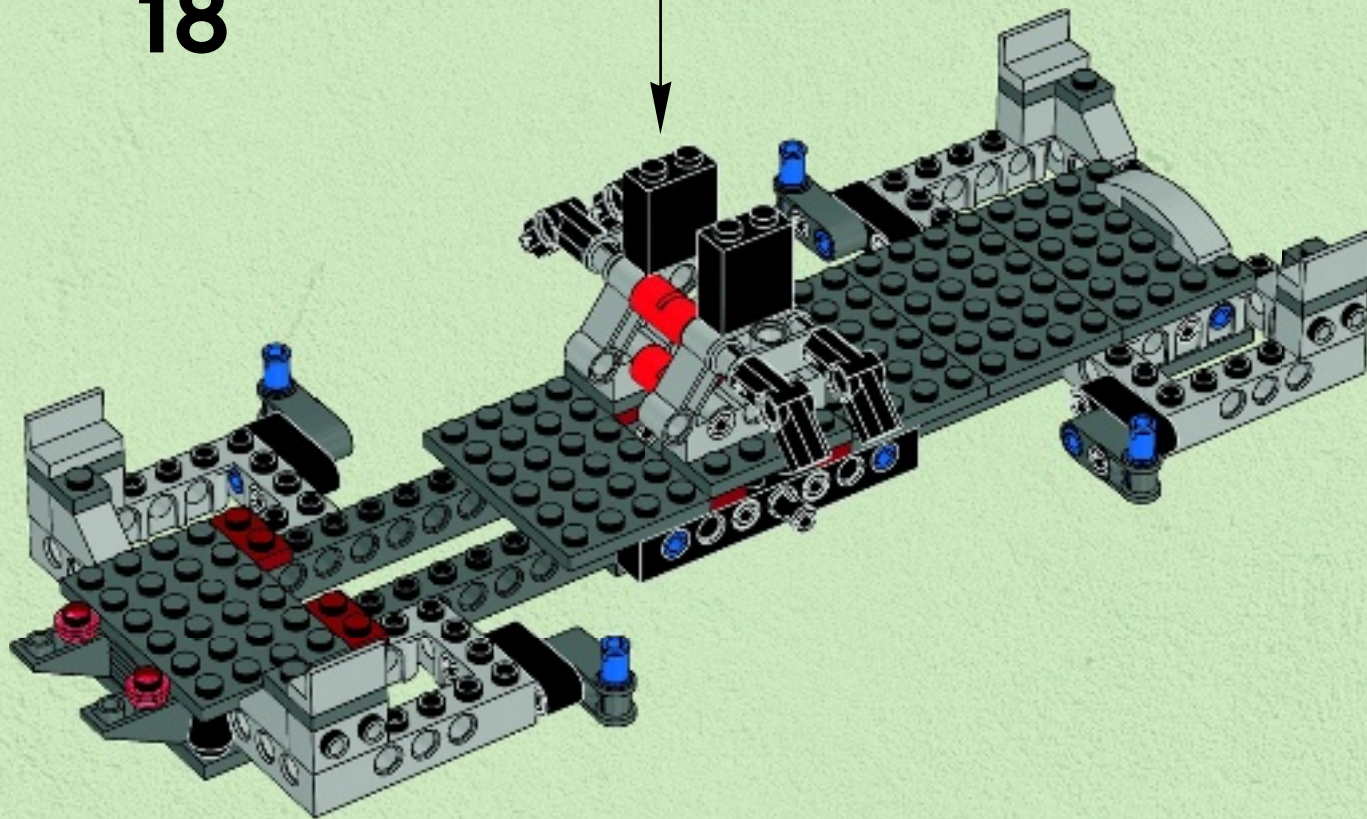

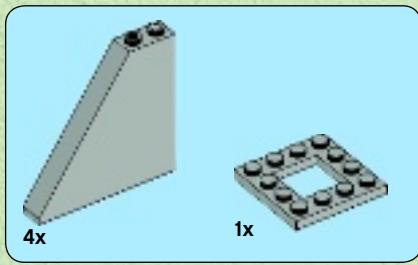

19

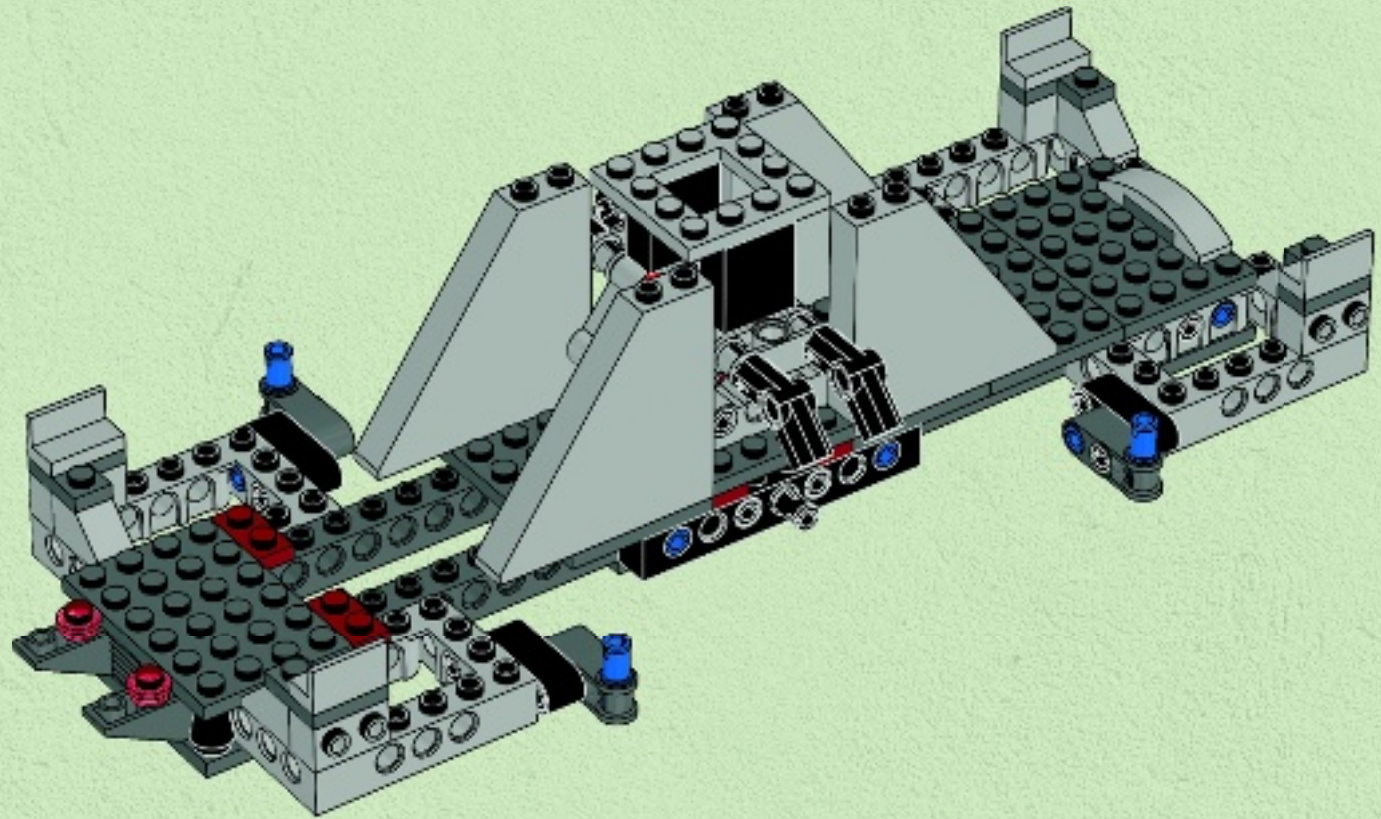

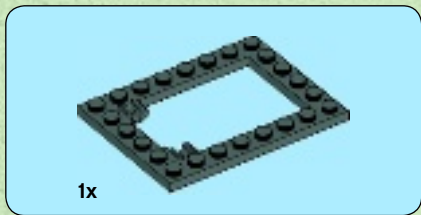

20

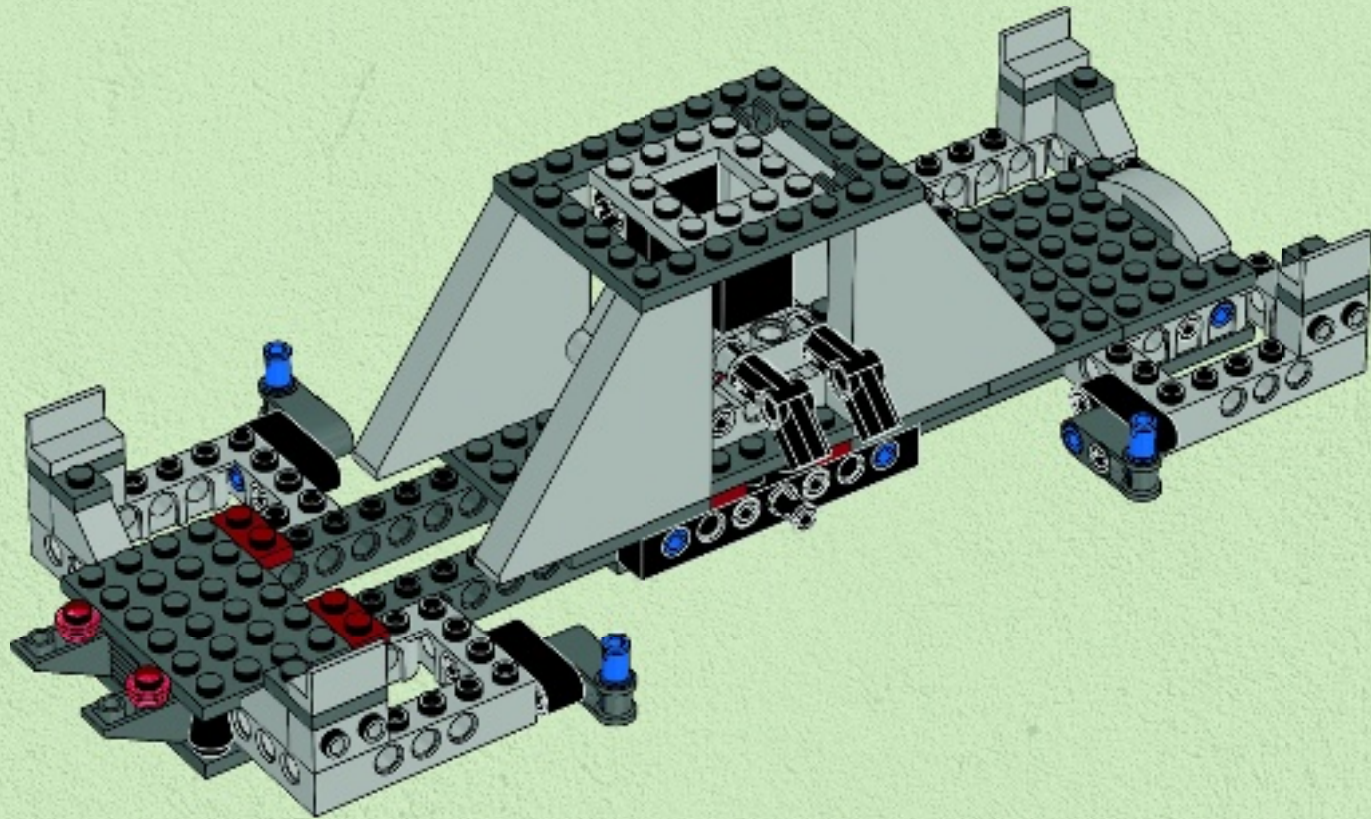



2x



1x

# 21

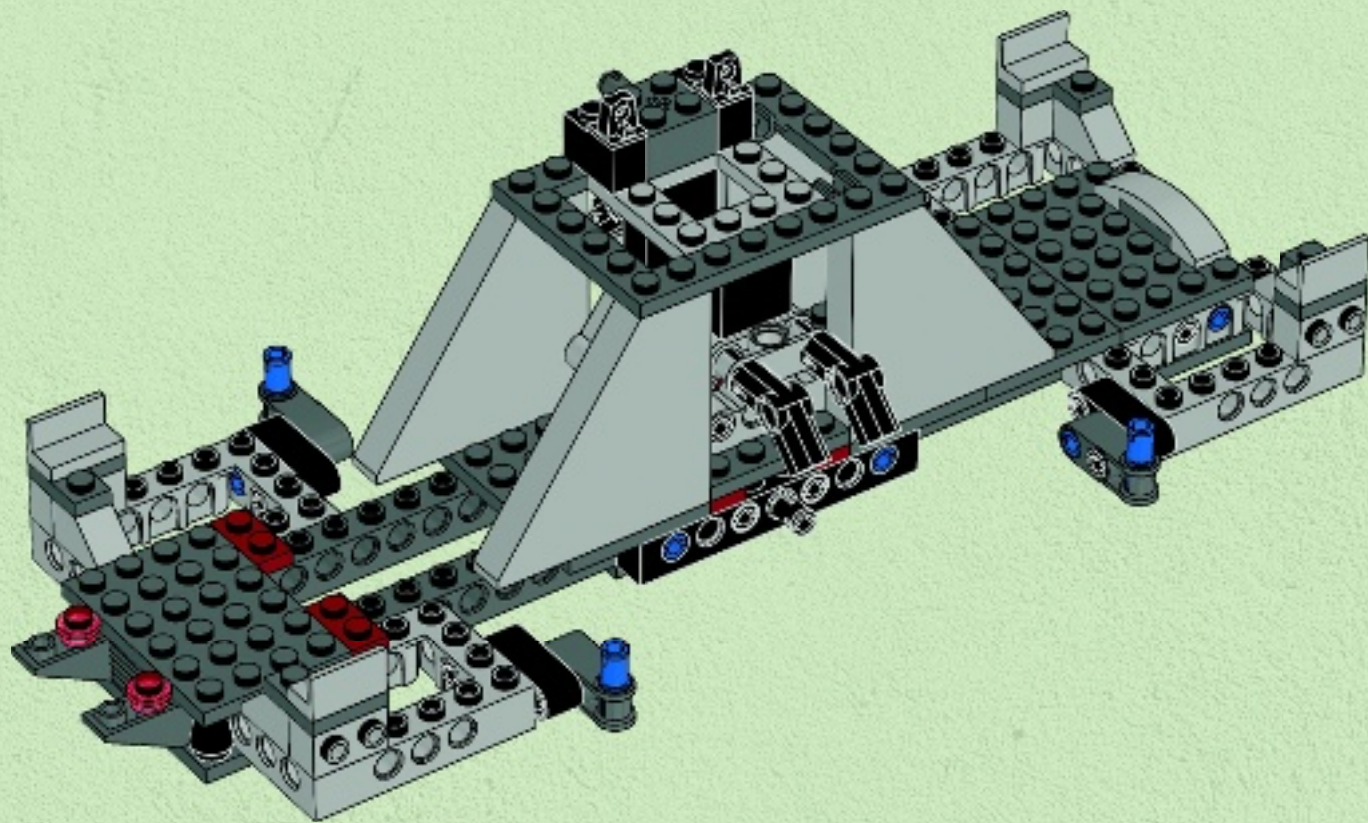

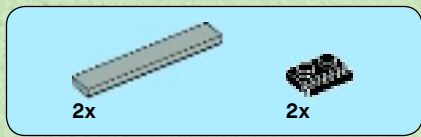

22

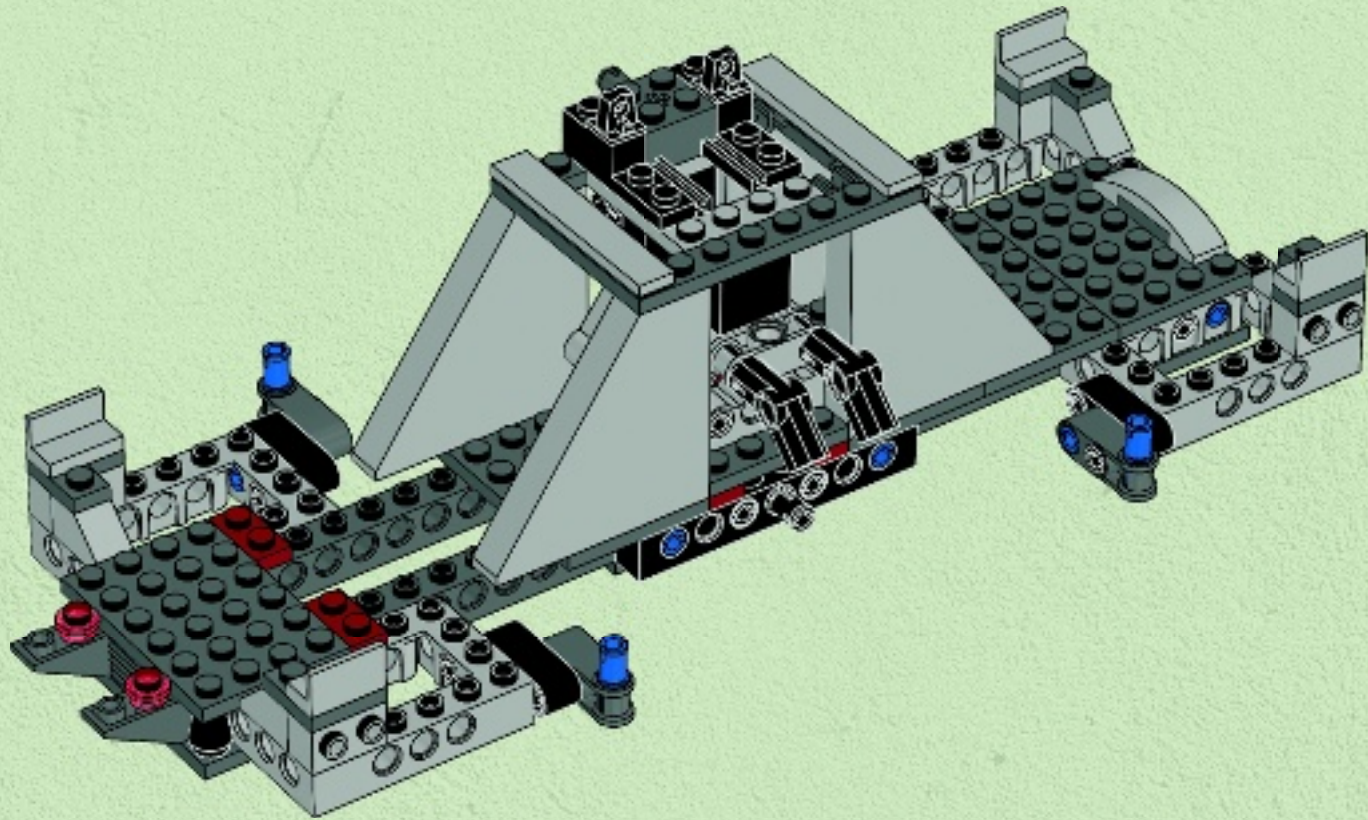



2x  1x 

# 23

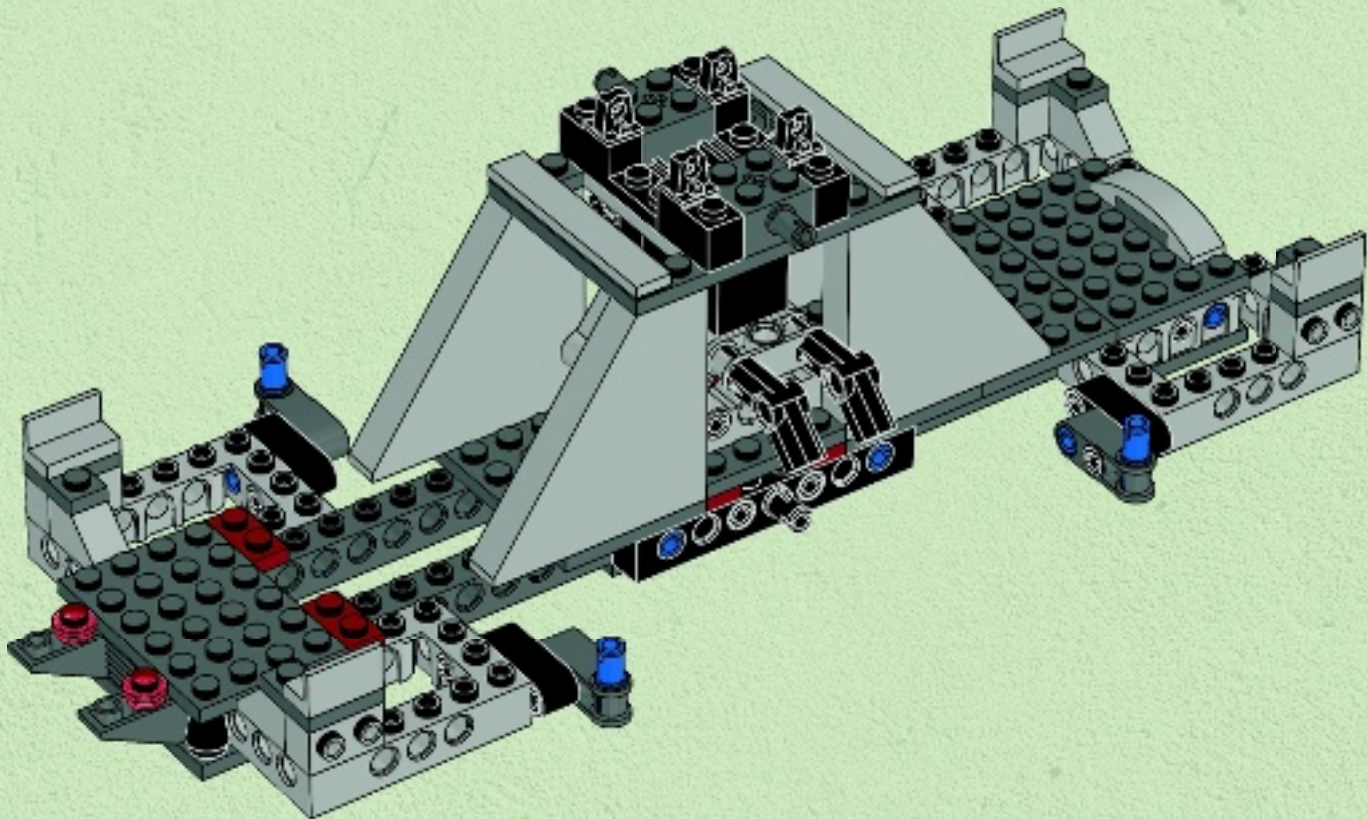

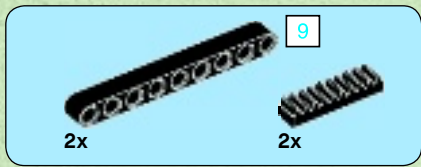

24

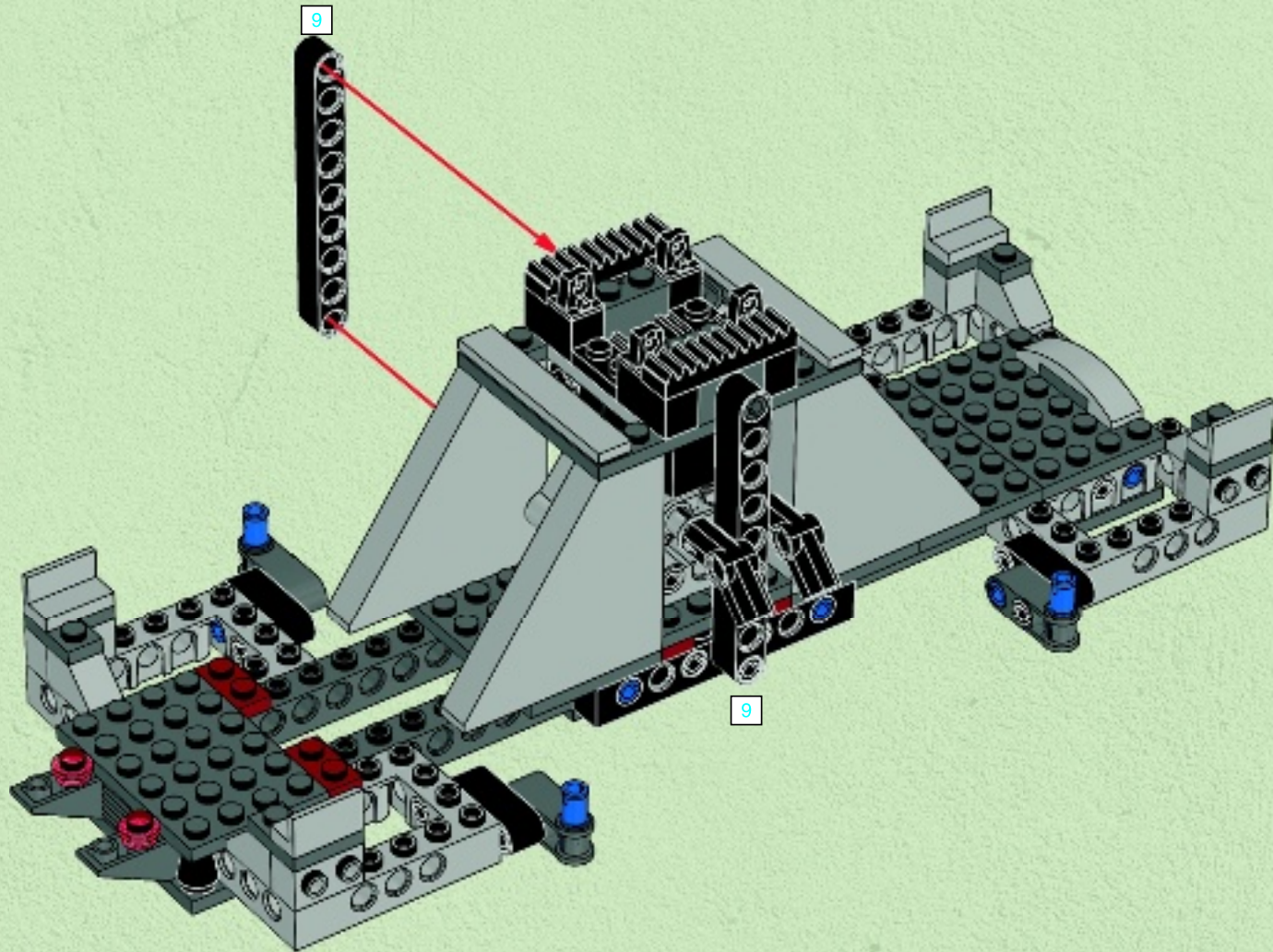

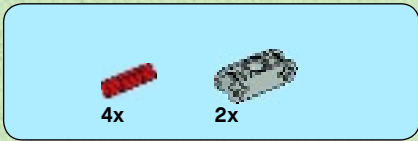

25

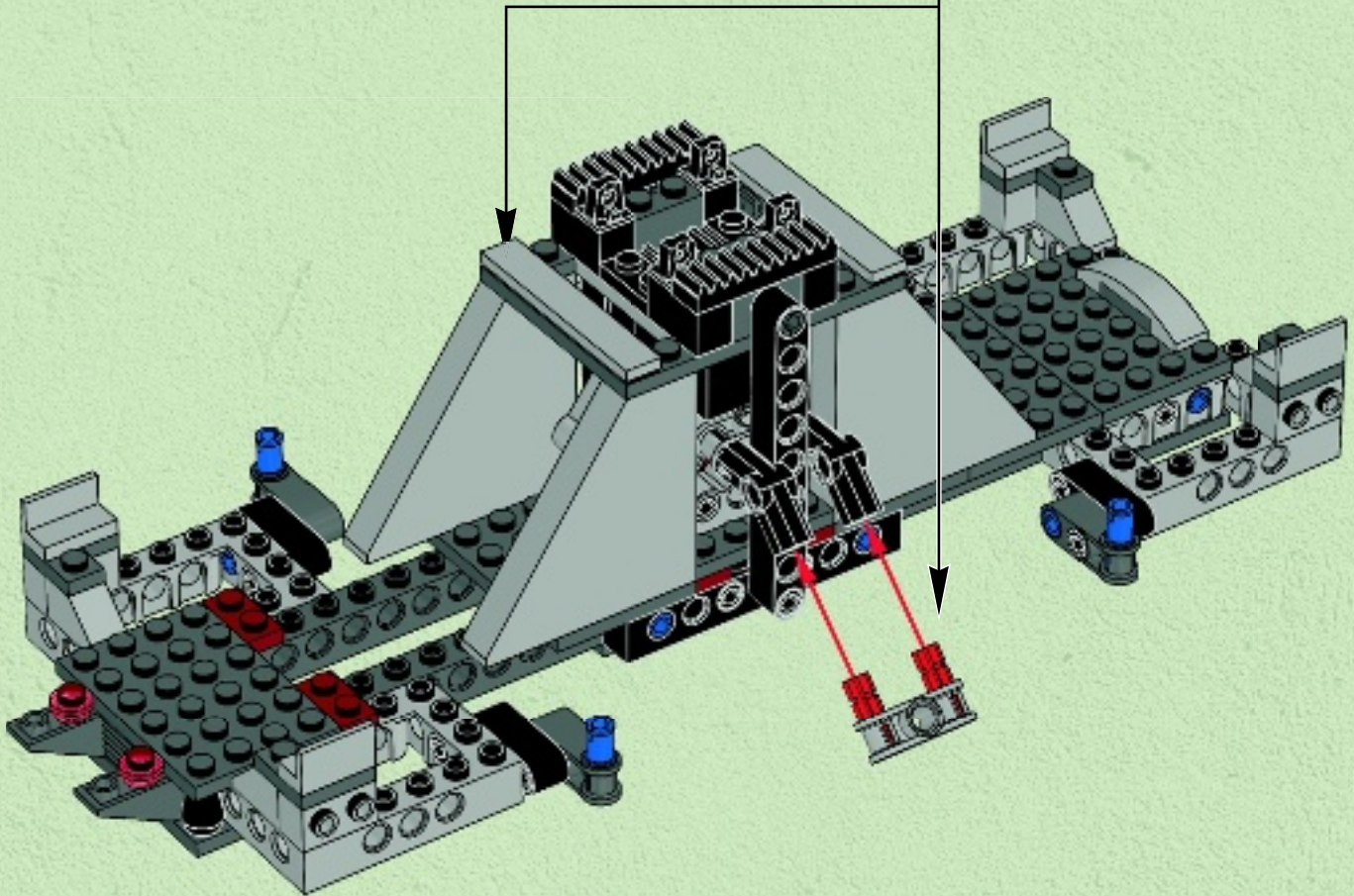
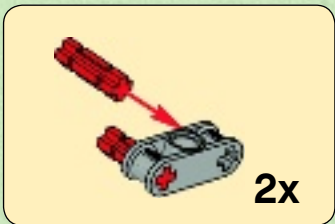

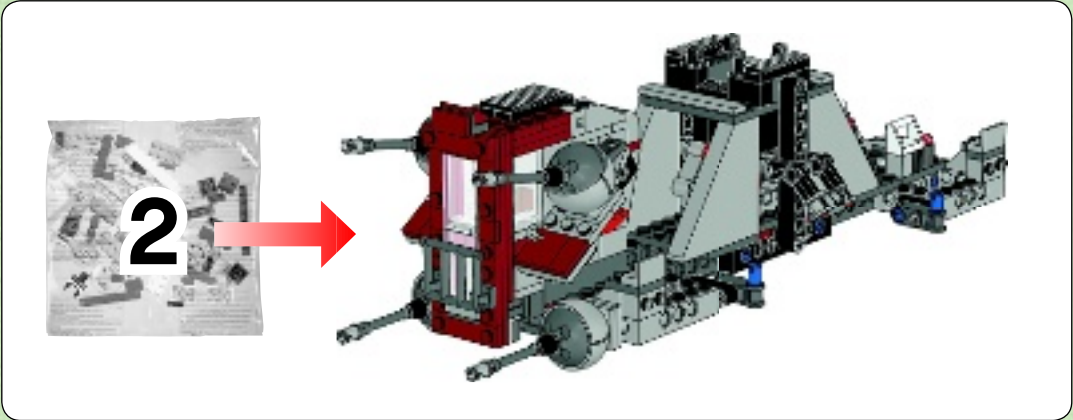

26

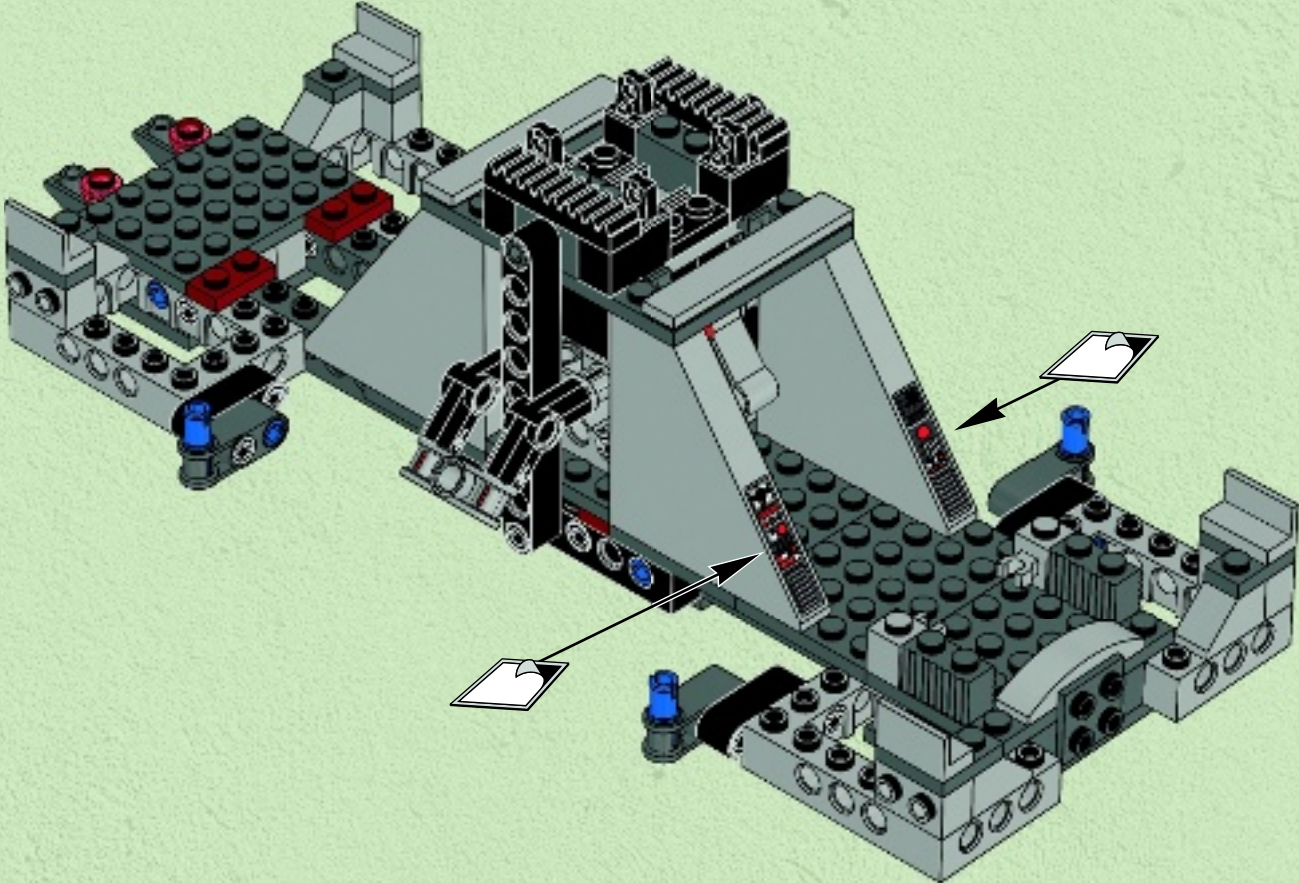
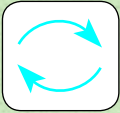

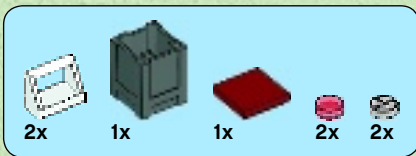

27

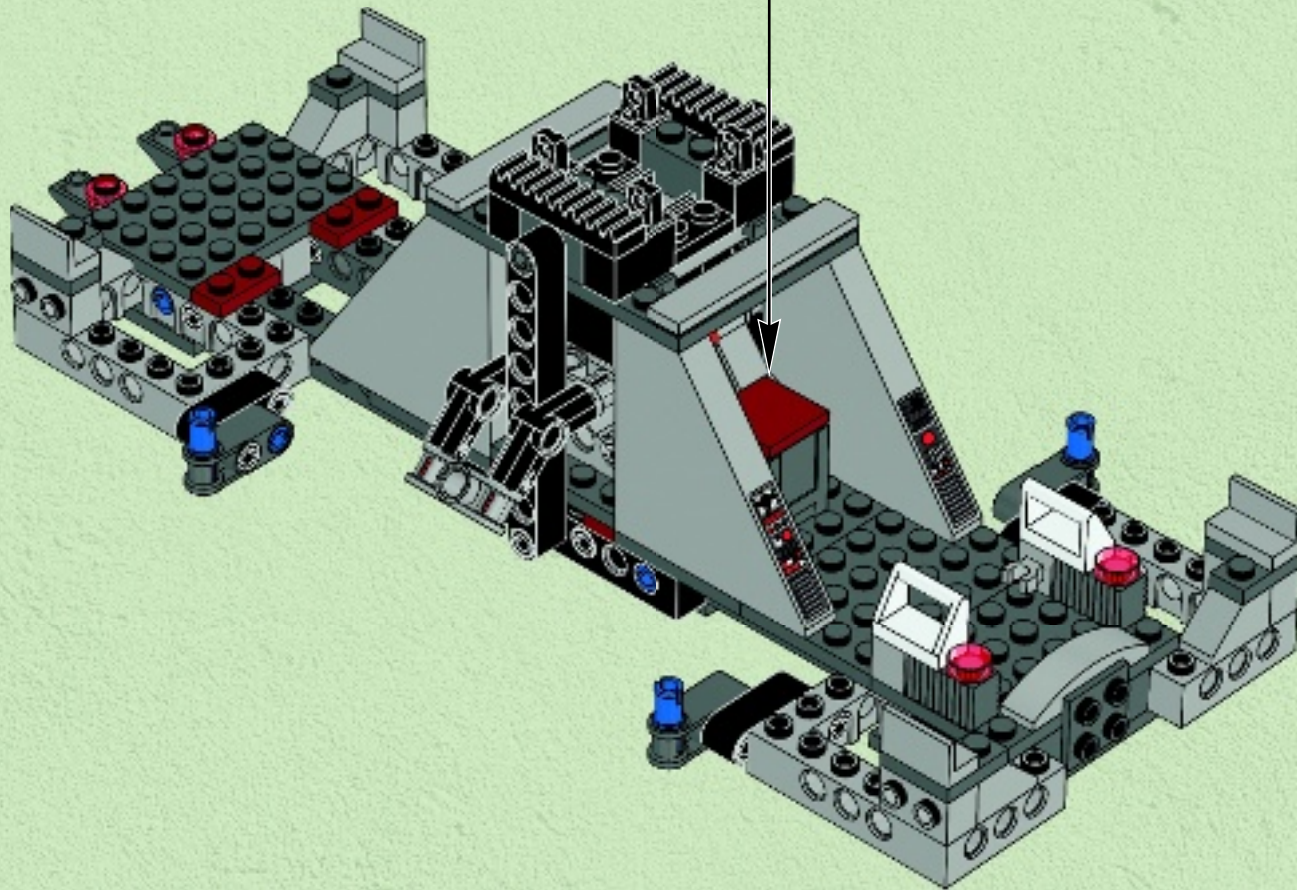
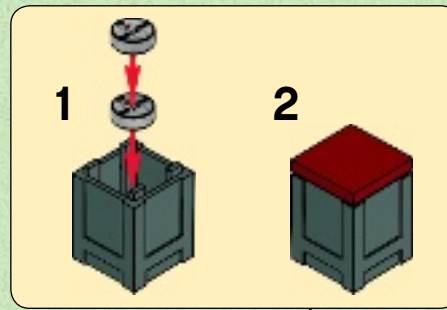

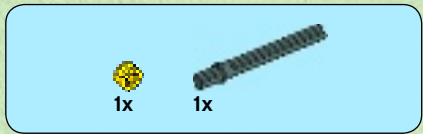
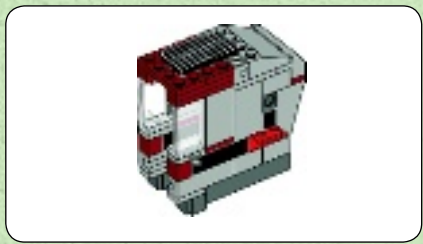

1

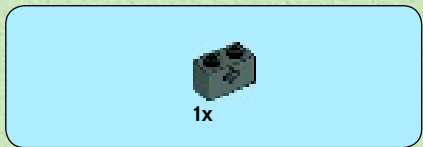
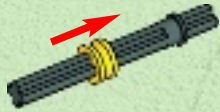

2

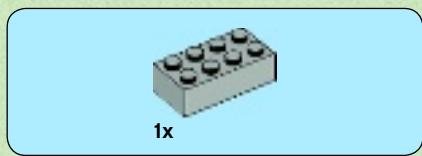
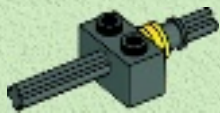

3

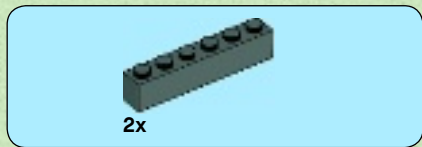
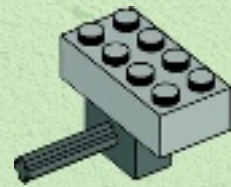

4

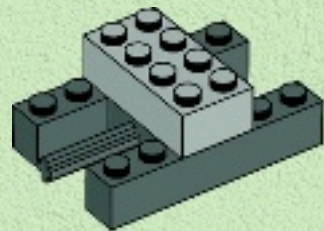

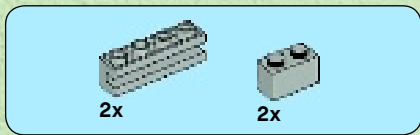

5

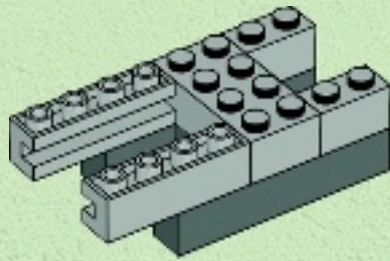

6

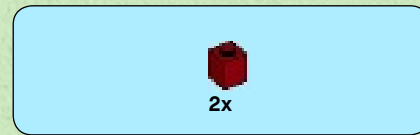
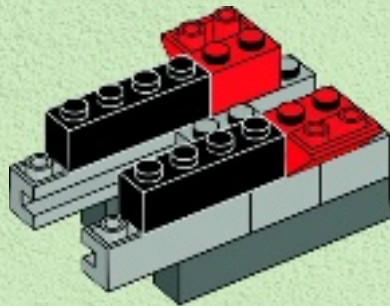

7

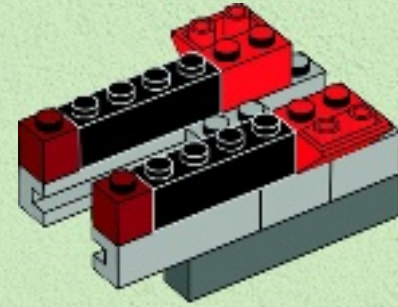

8

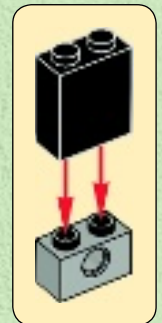
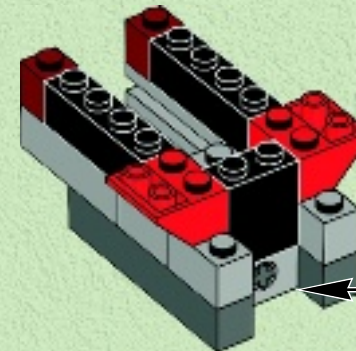

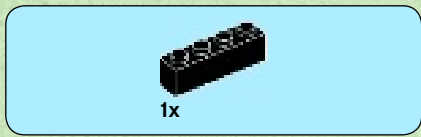

9

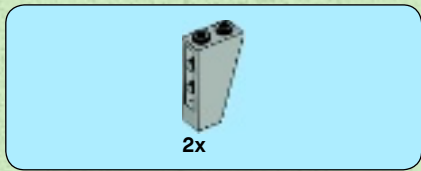
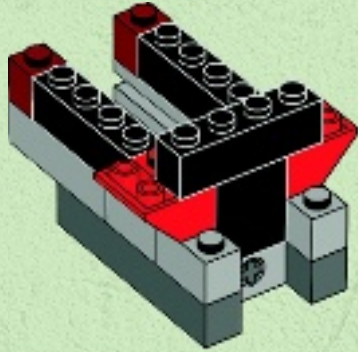

10

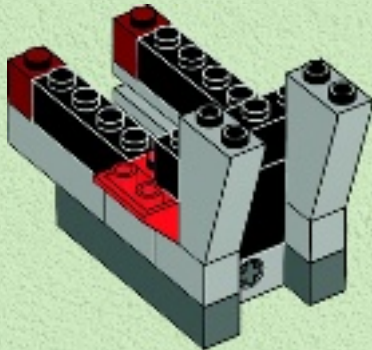

11

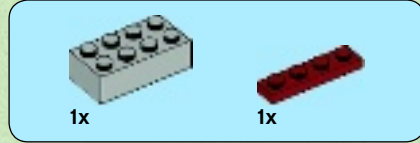
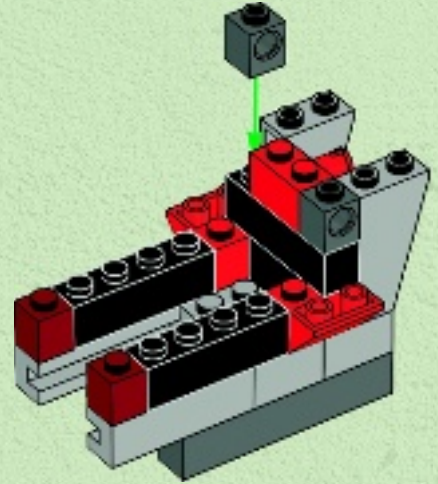
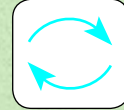

12

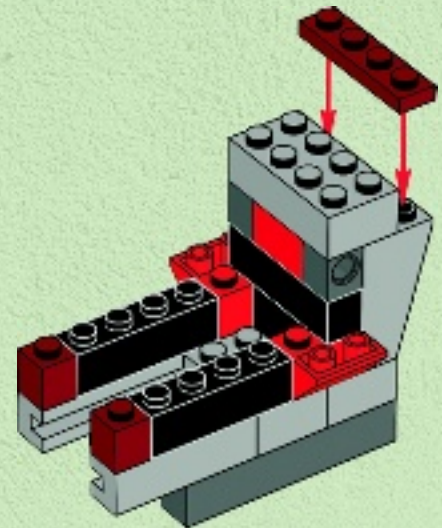



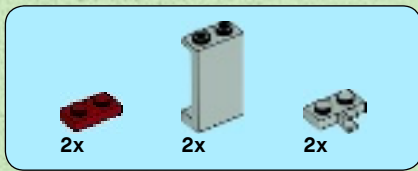

13

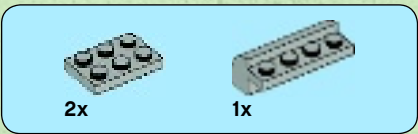
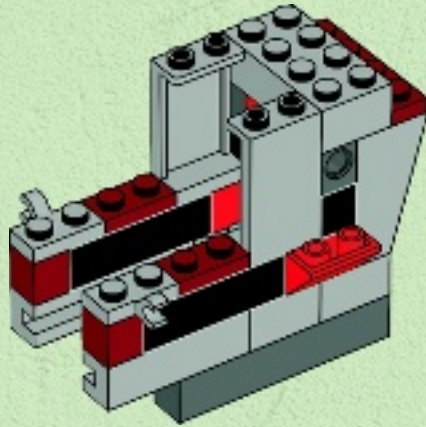

14

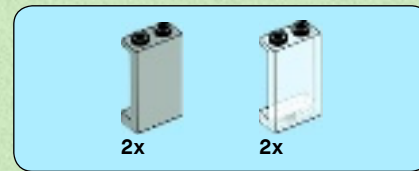
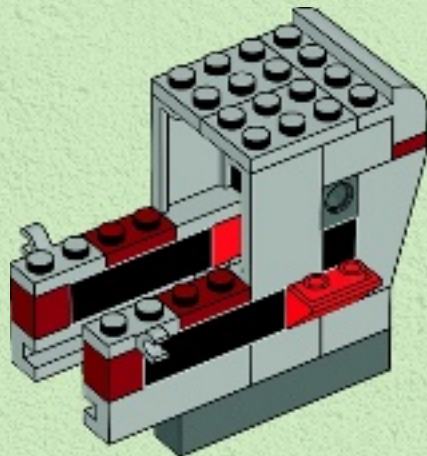

15

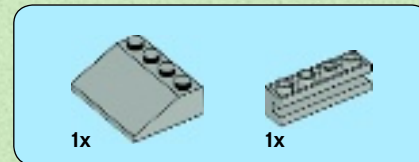
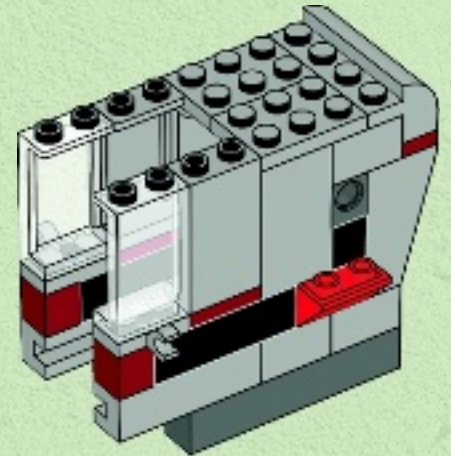

16

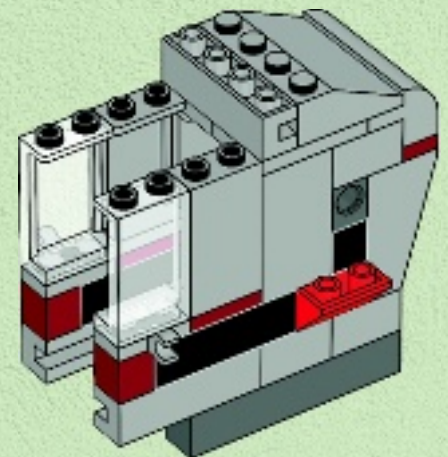



17

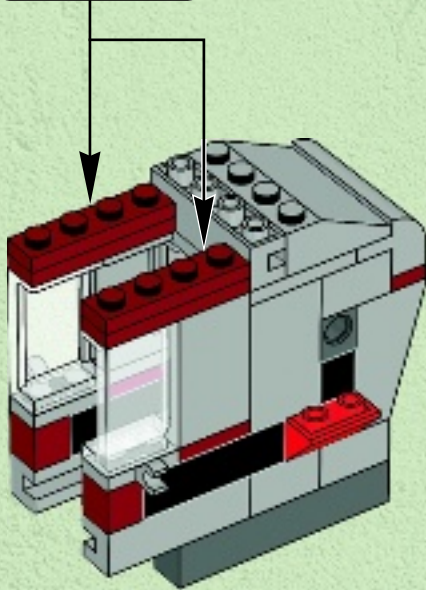
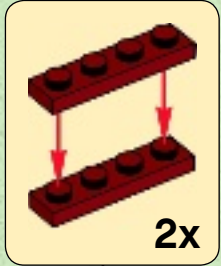

18

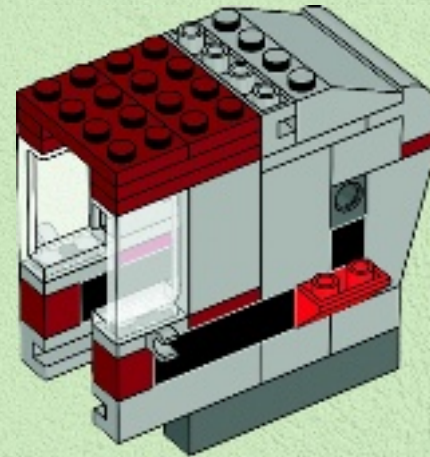



2x

# 19

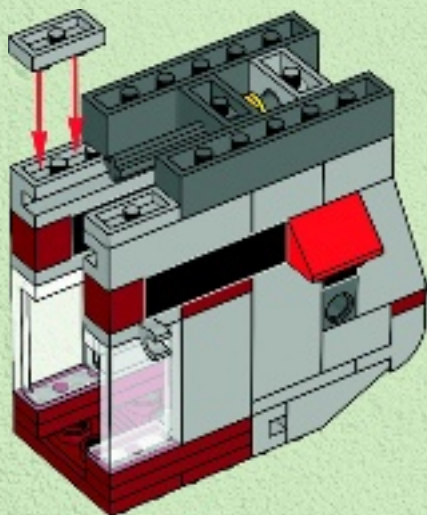
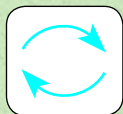

2x



2x

# 20

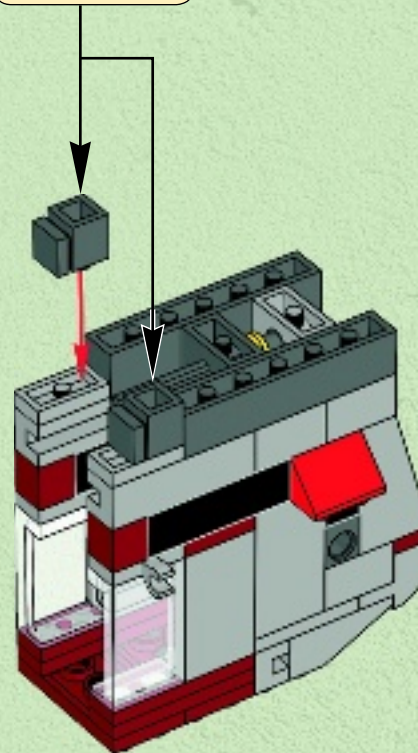
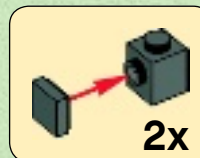



21

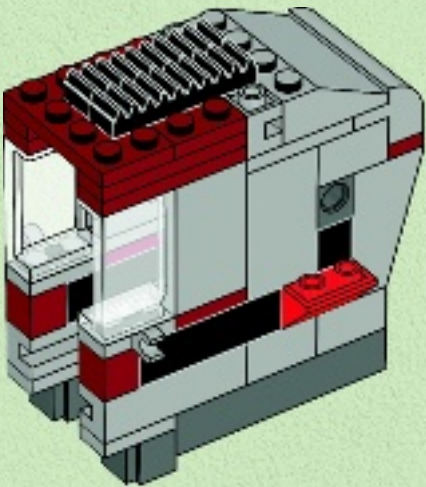

28

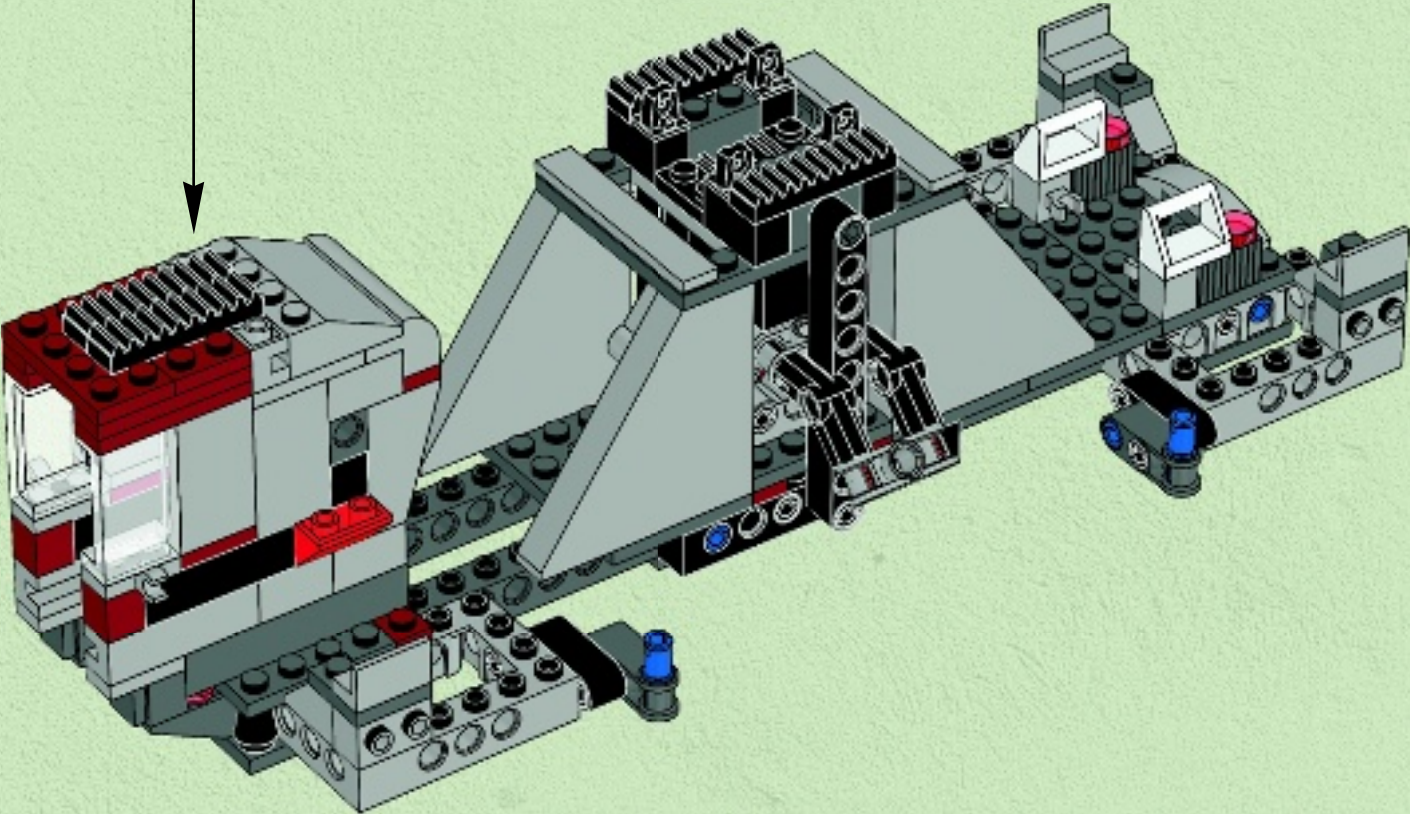

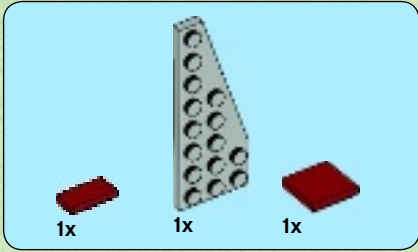

1

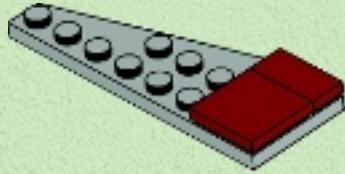

2

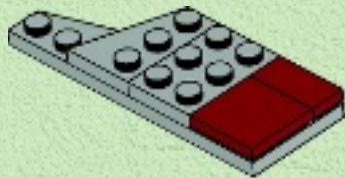

3

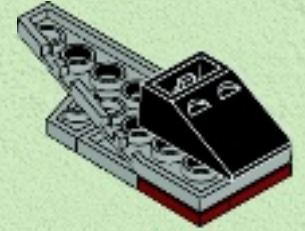
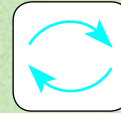

4

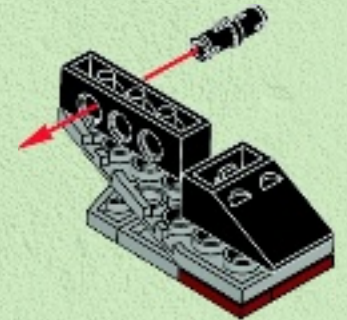



5

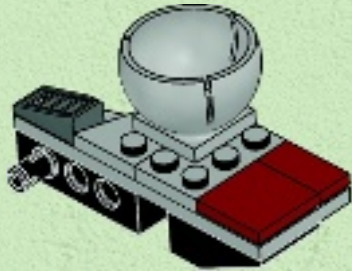

6

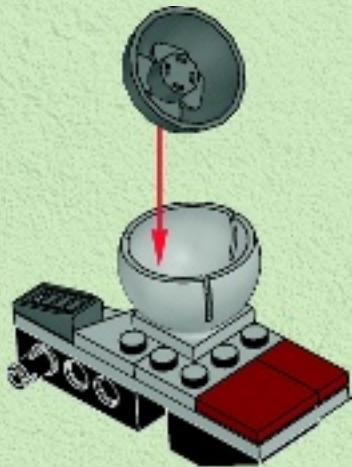

7

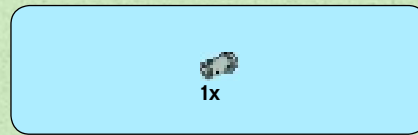
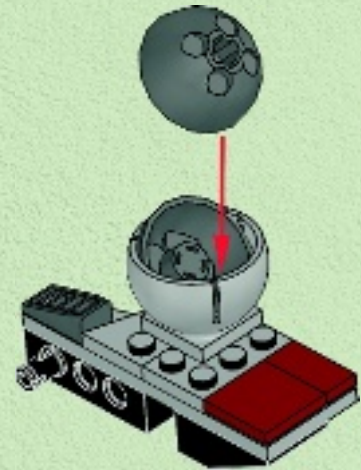

8

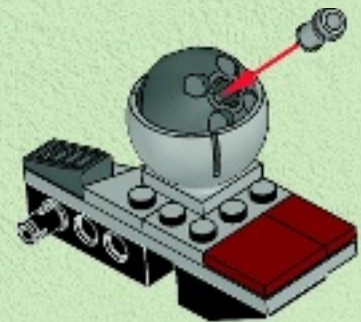



1x

9

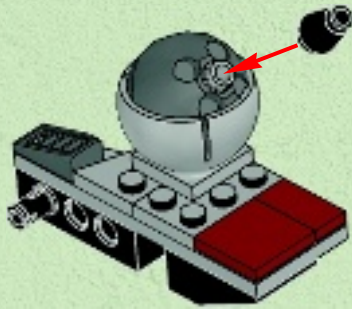

1x



1x

10

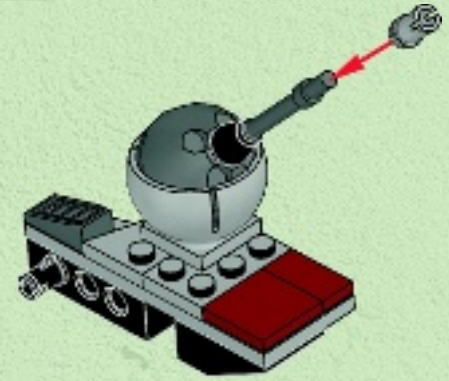

29

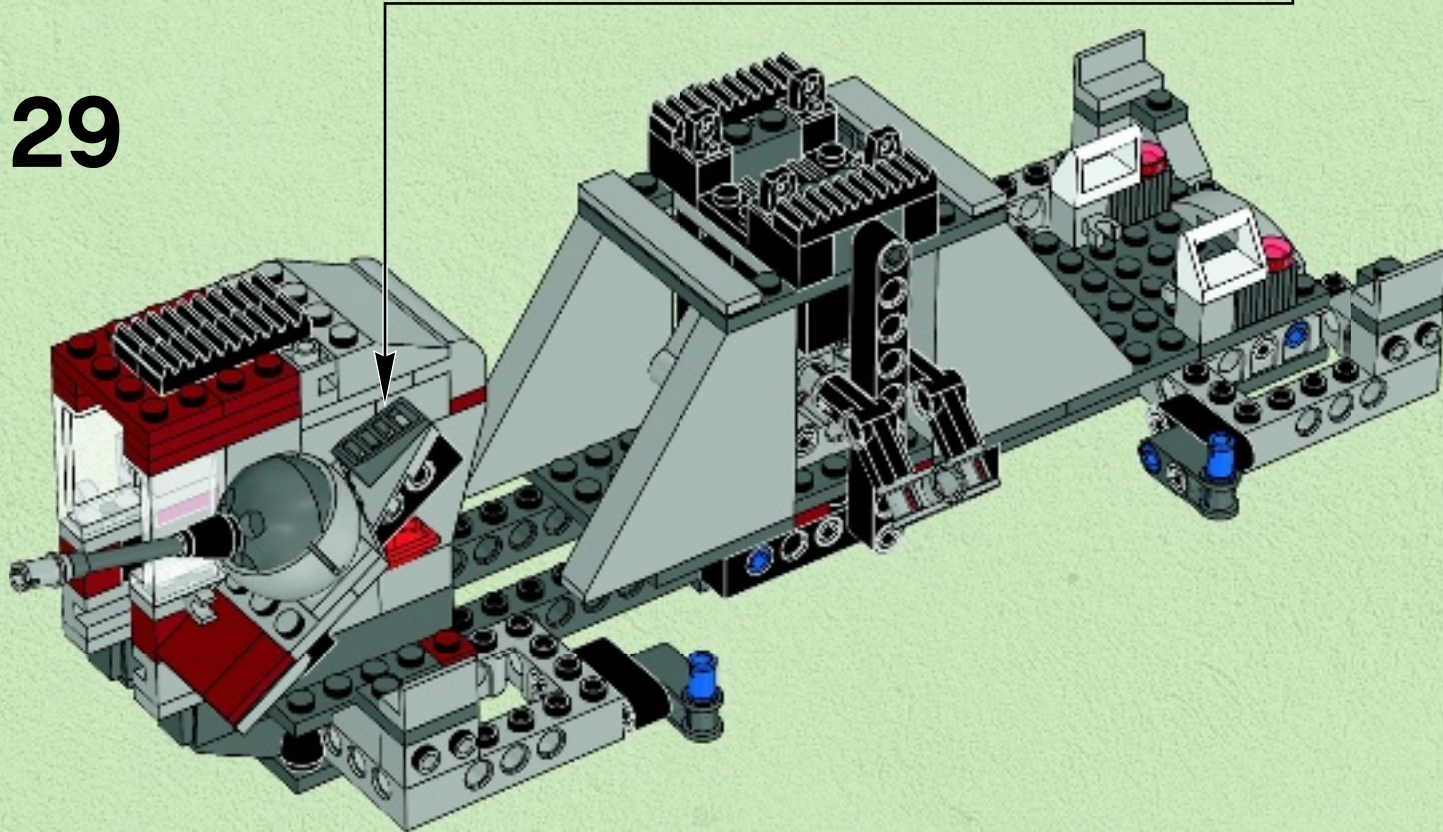

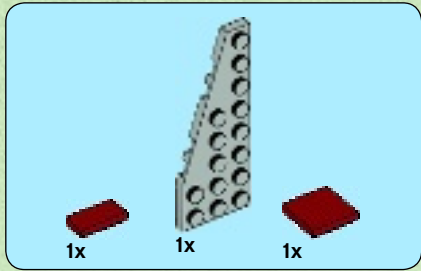

1

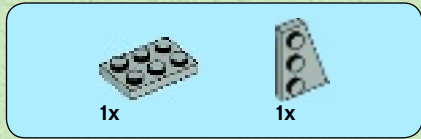
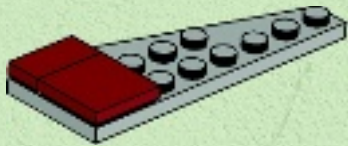

2

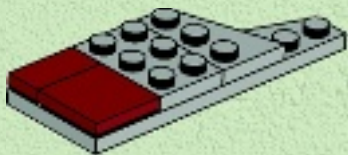

3

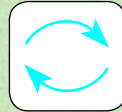

4

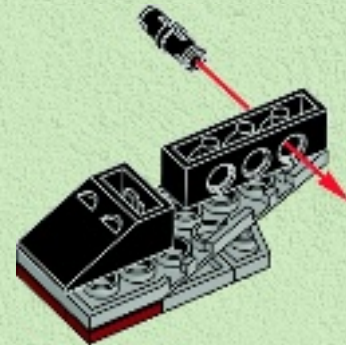





5

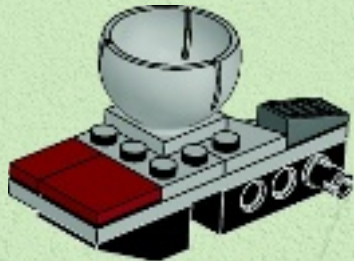
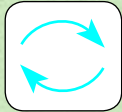

6

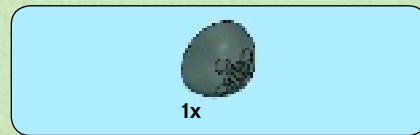
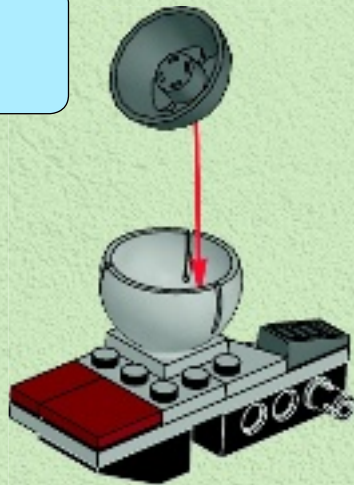

7

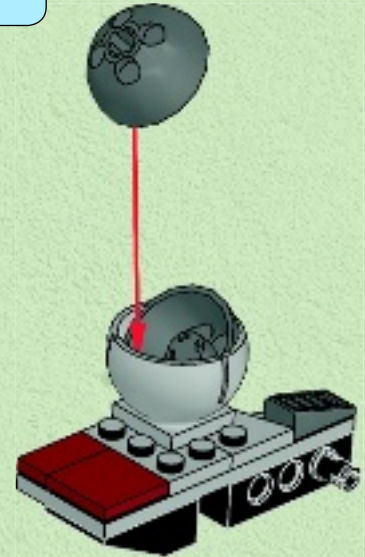

8

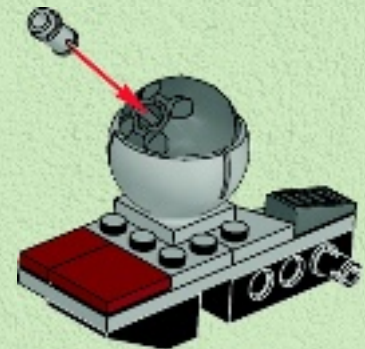



1x

9

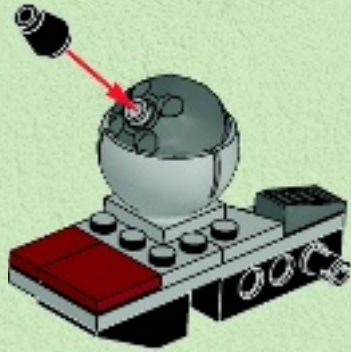

1x

1x

10

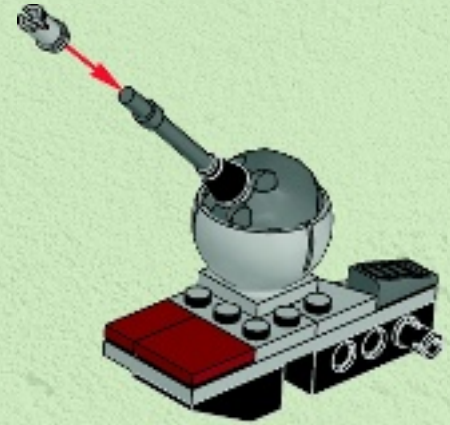

30

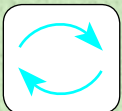
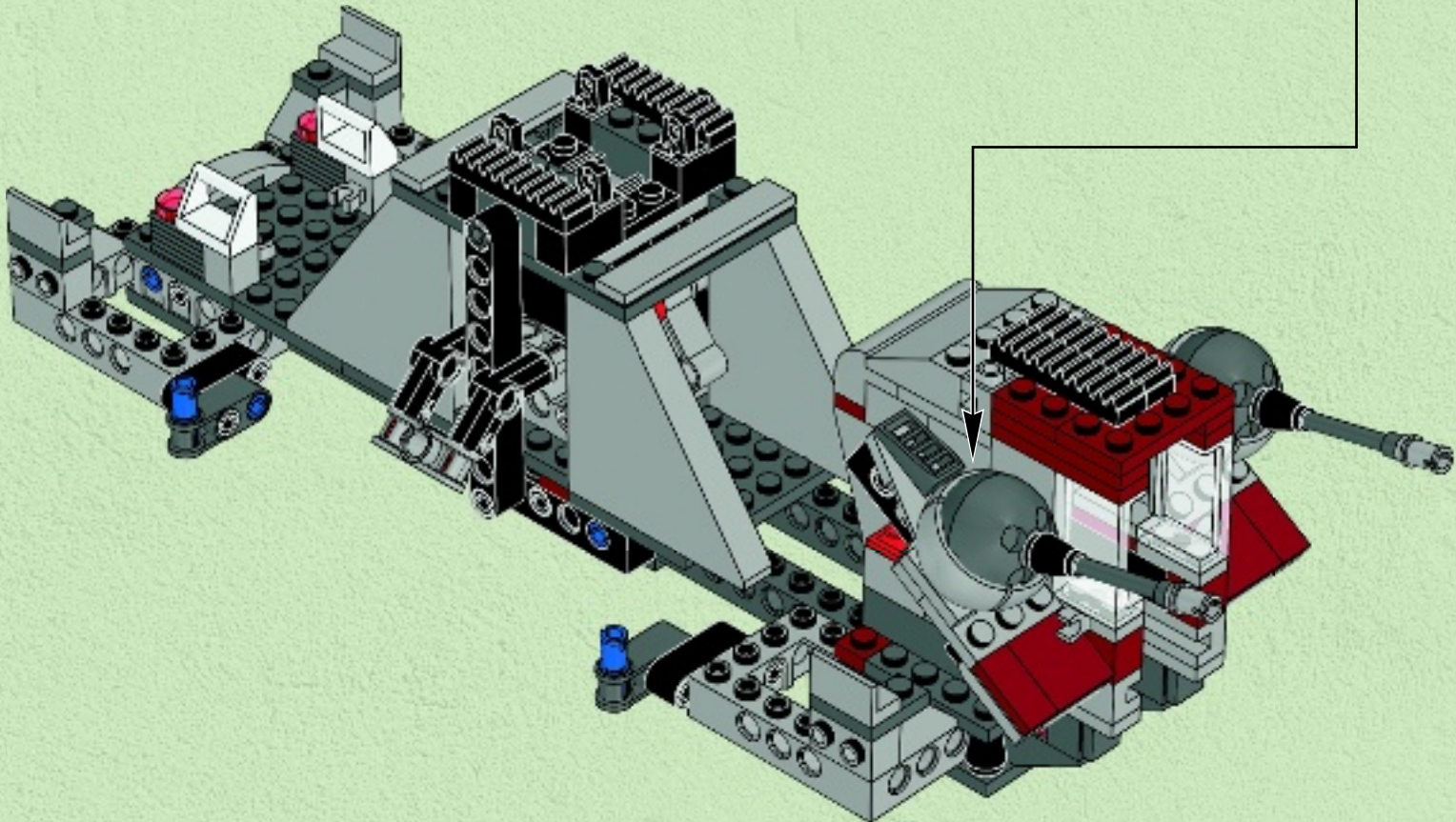

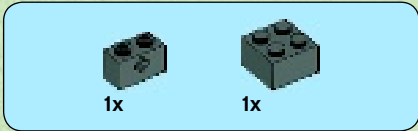

1

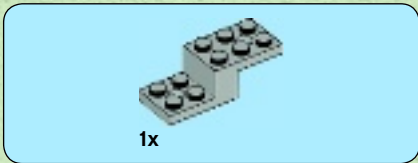
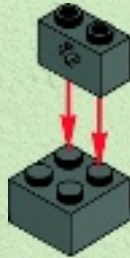

2

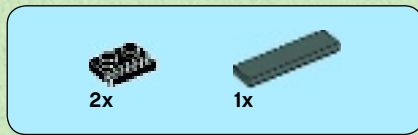
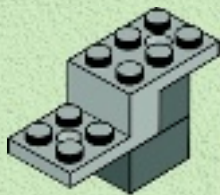

3

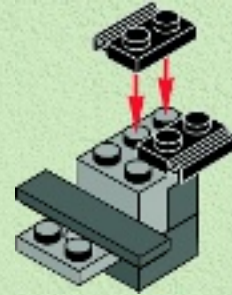

4





5

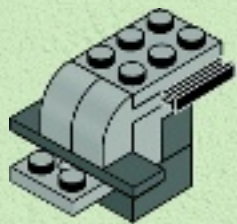

6

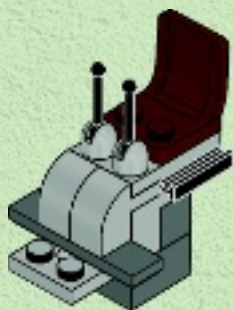

7

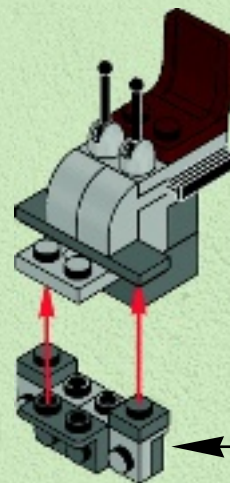
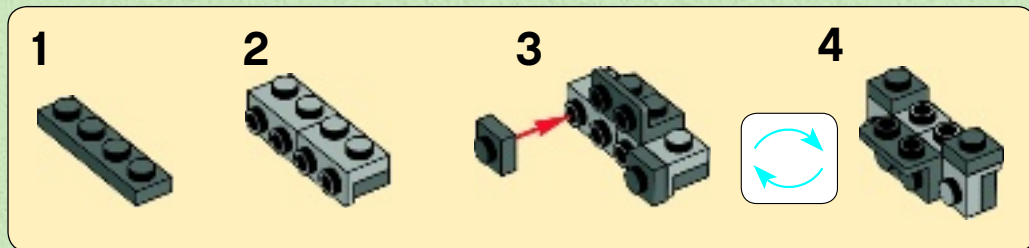

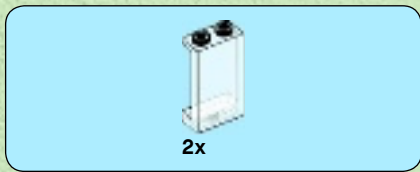

8



9



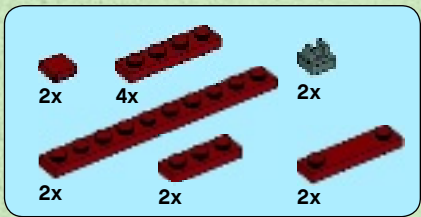

10

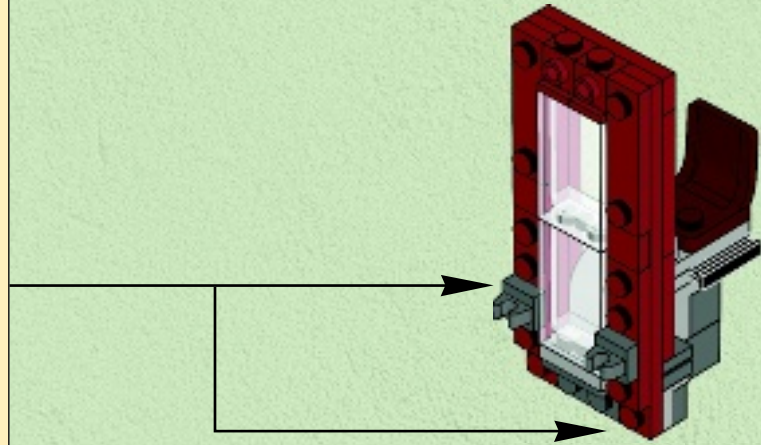
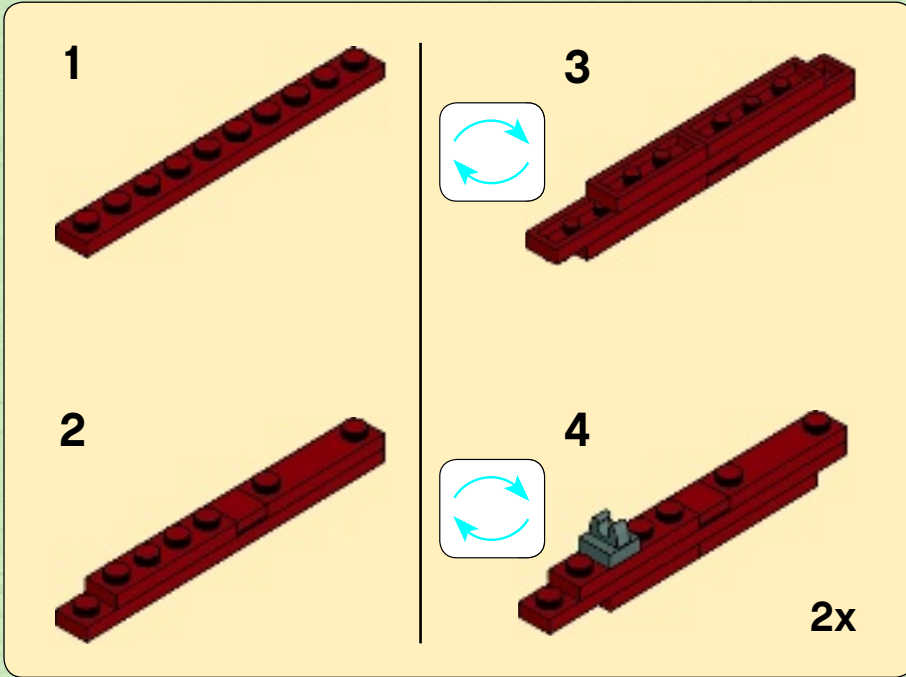



11

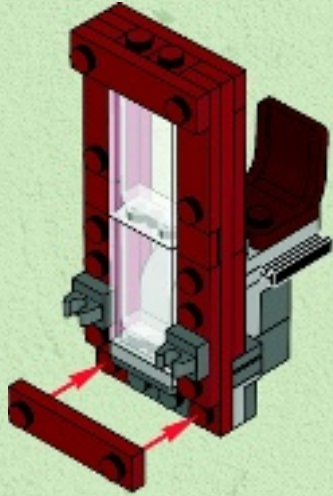

12

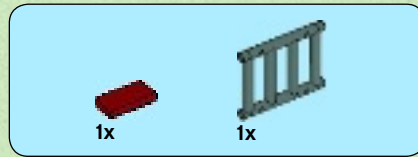
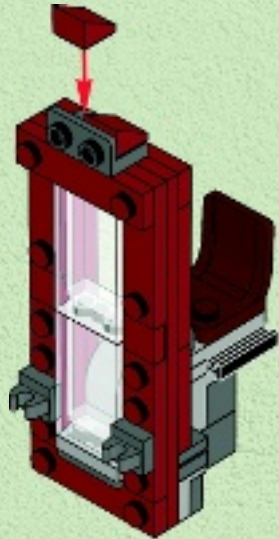

13

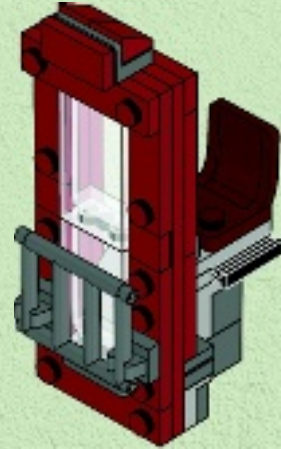

31

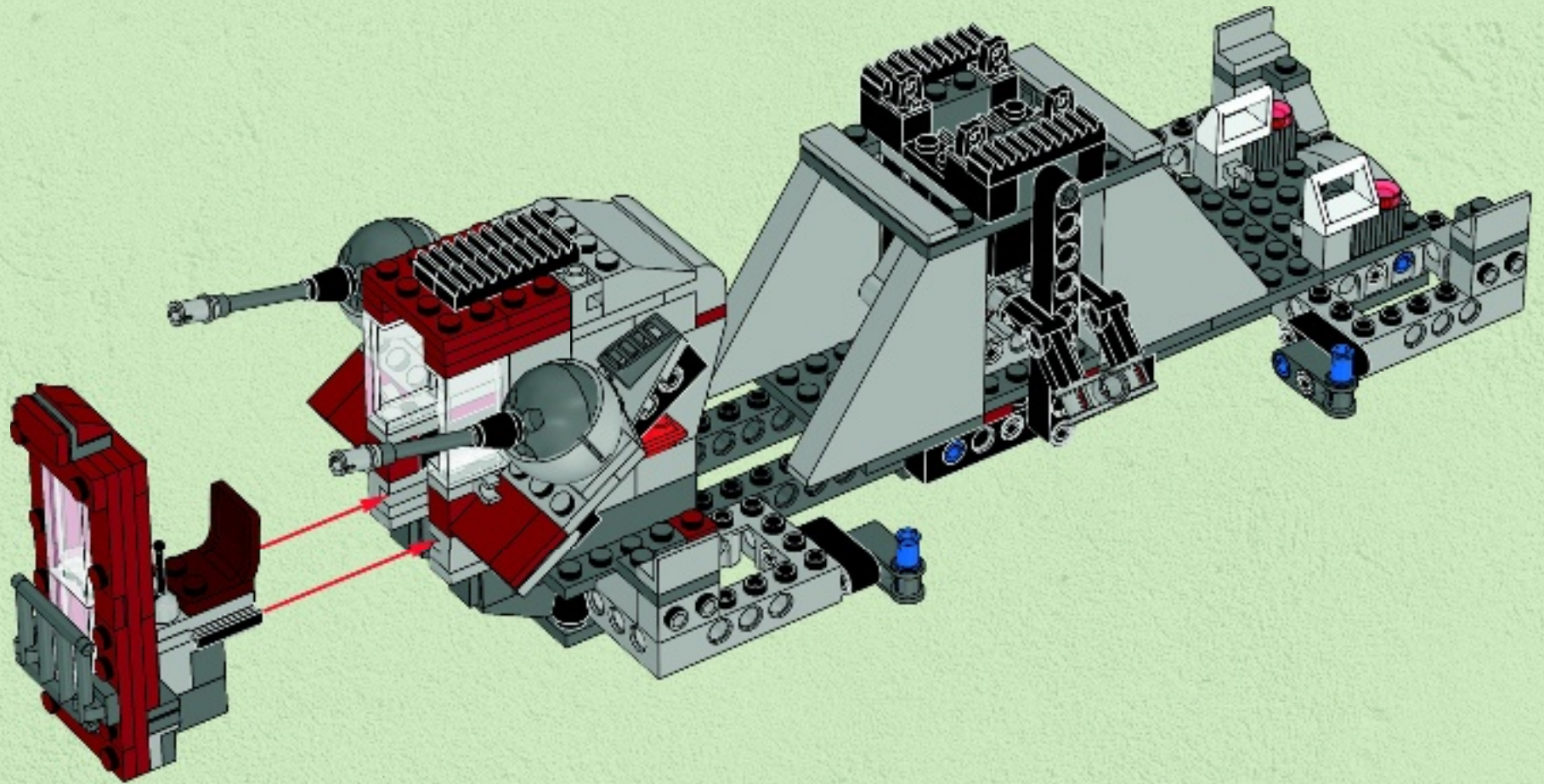





1x

32

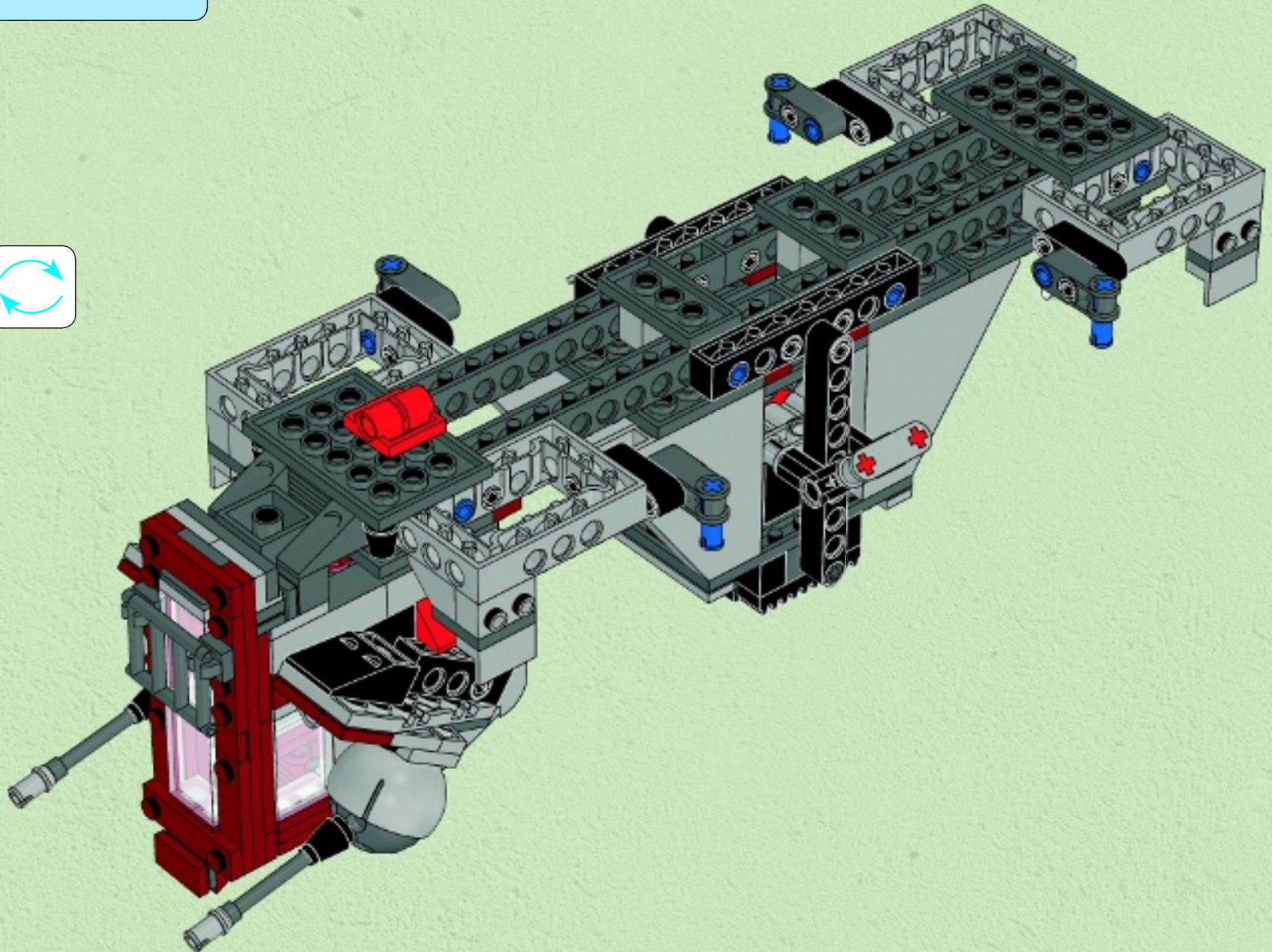

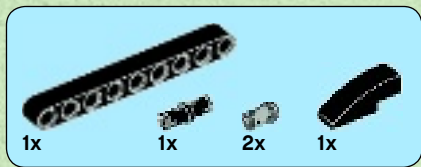

# 33

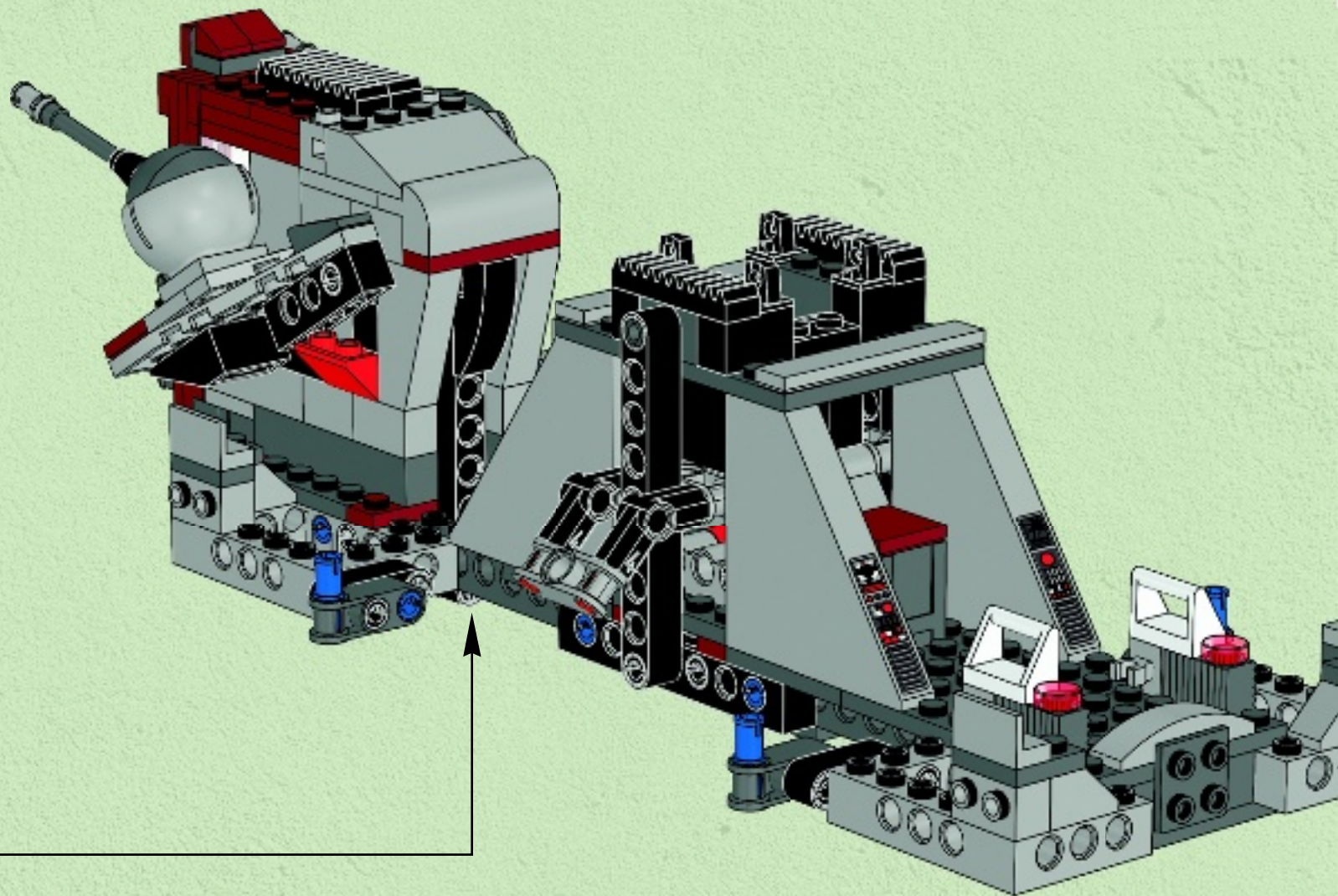
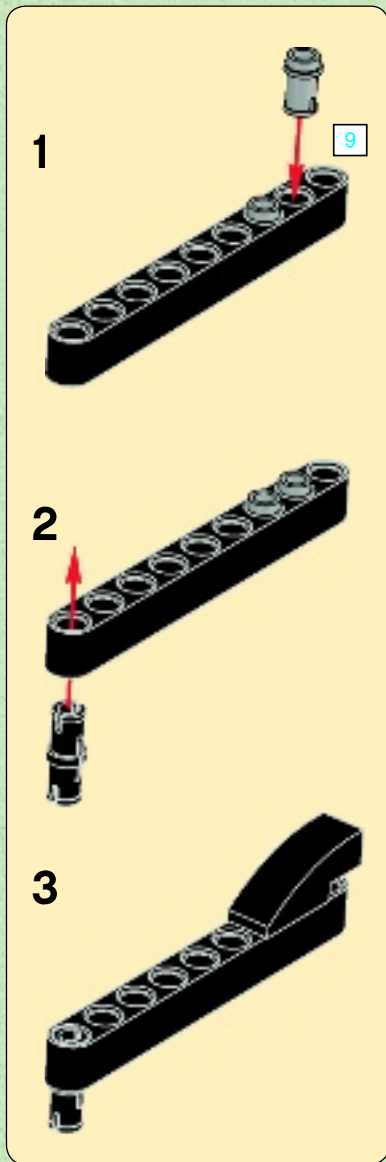

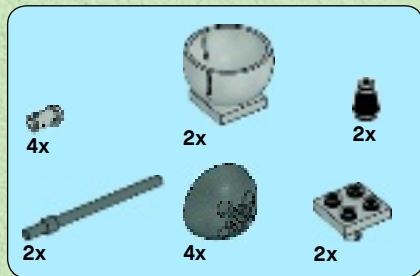

34

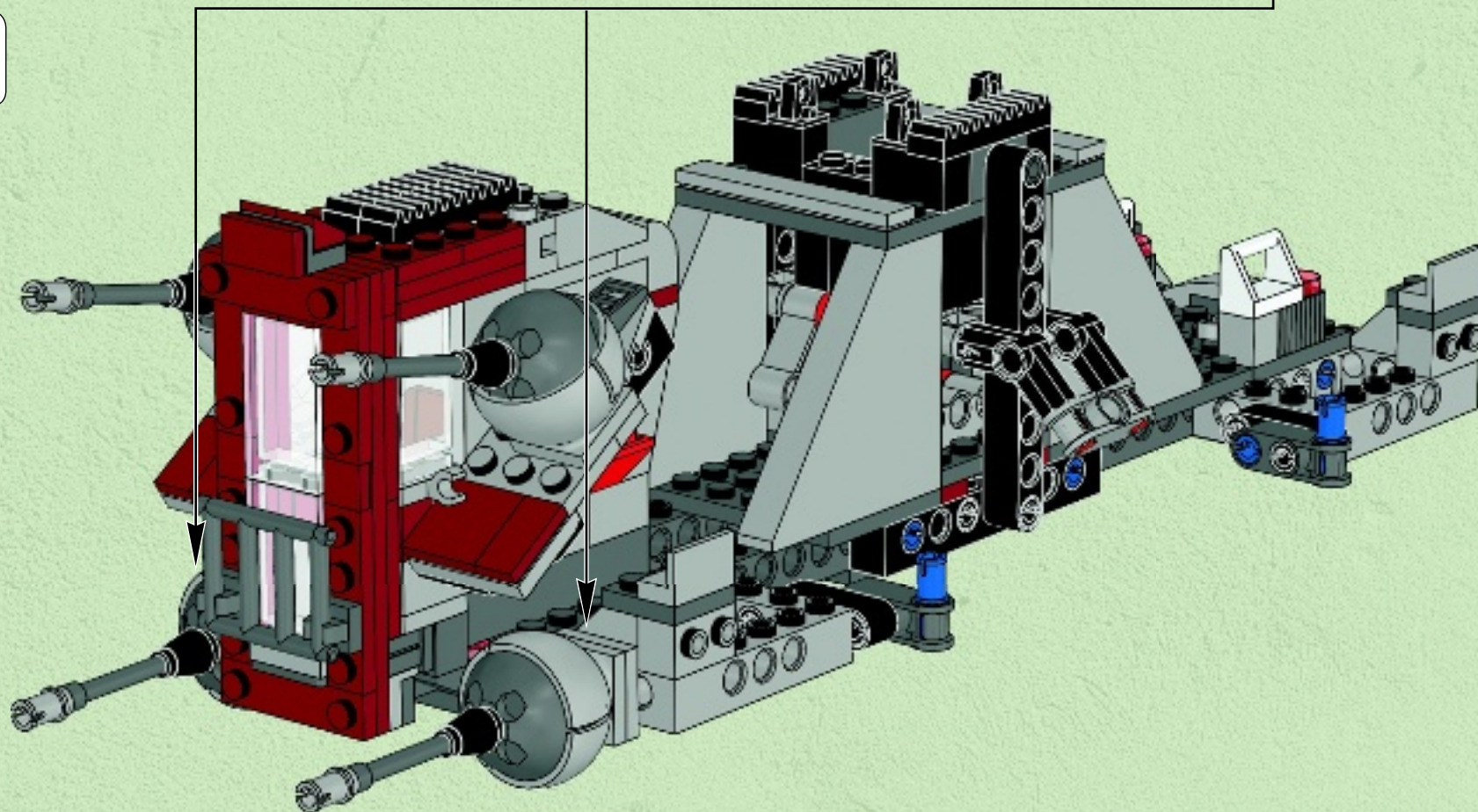
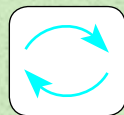
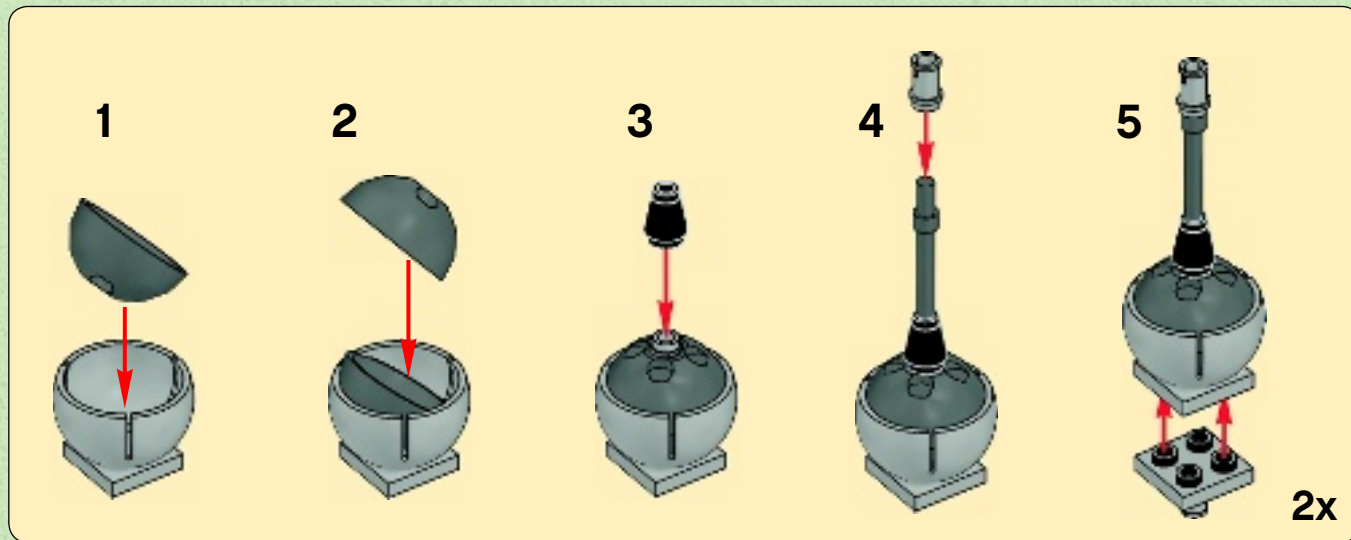

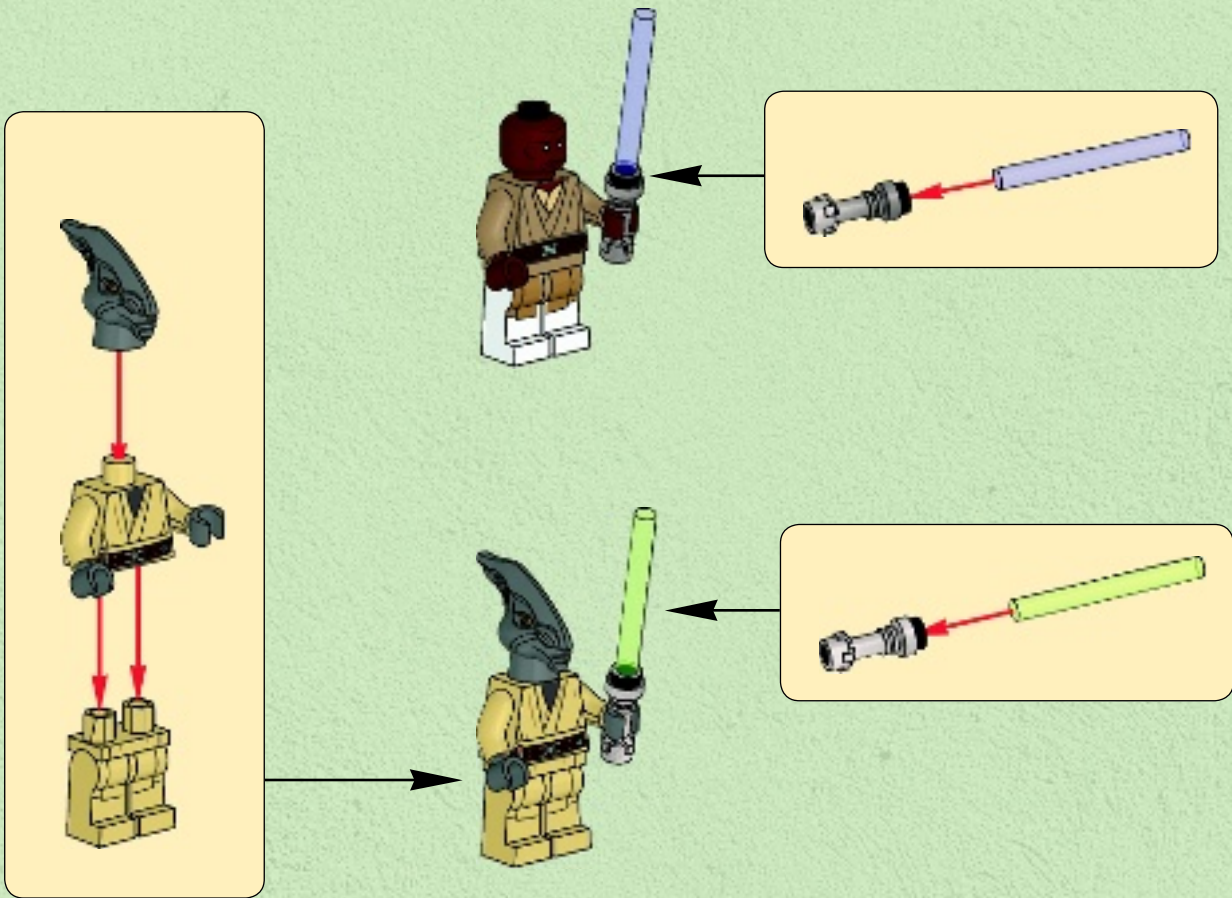
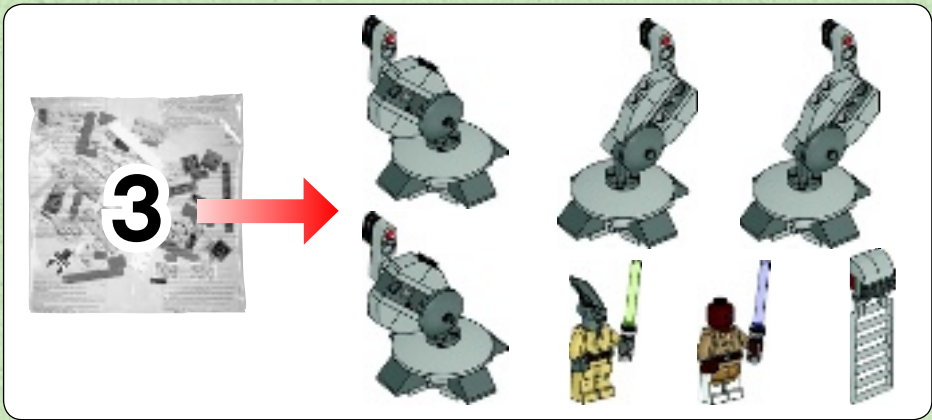

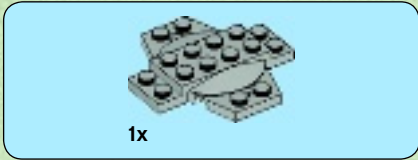

1

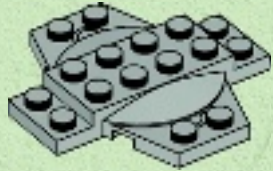

2

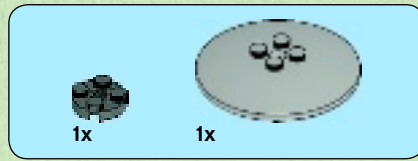

3

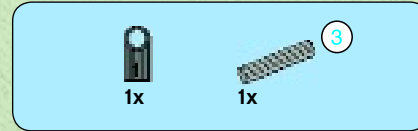
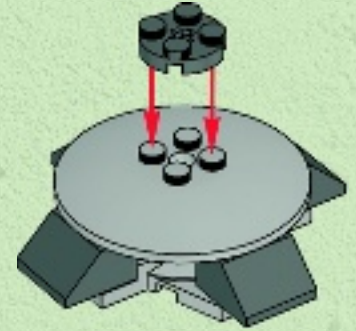

4

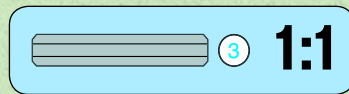
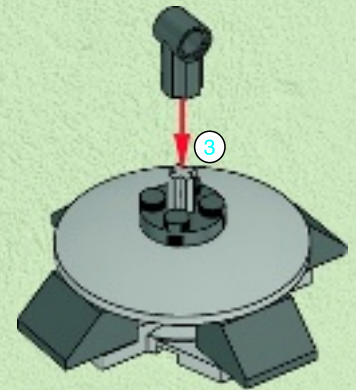

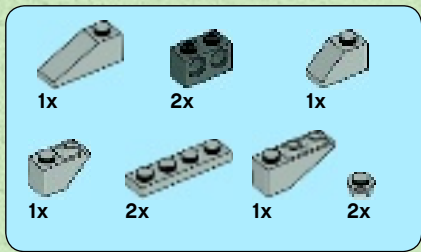

5

1

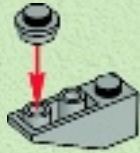

2

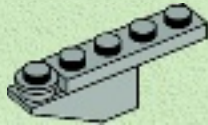

3

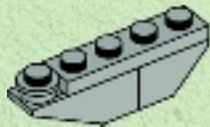

4

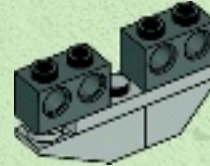

5

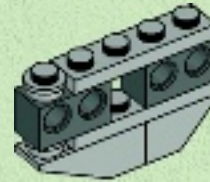

6

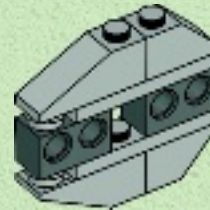

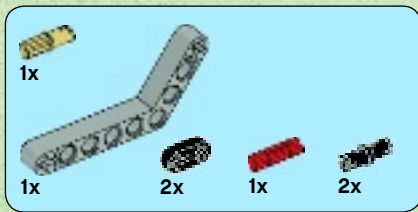

6

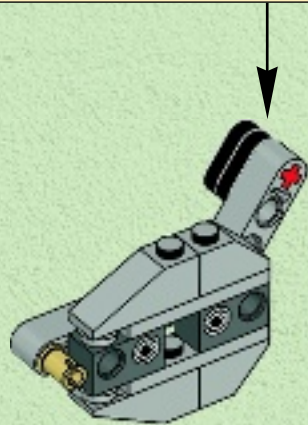
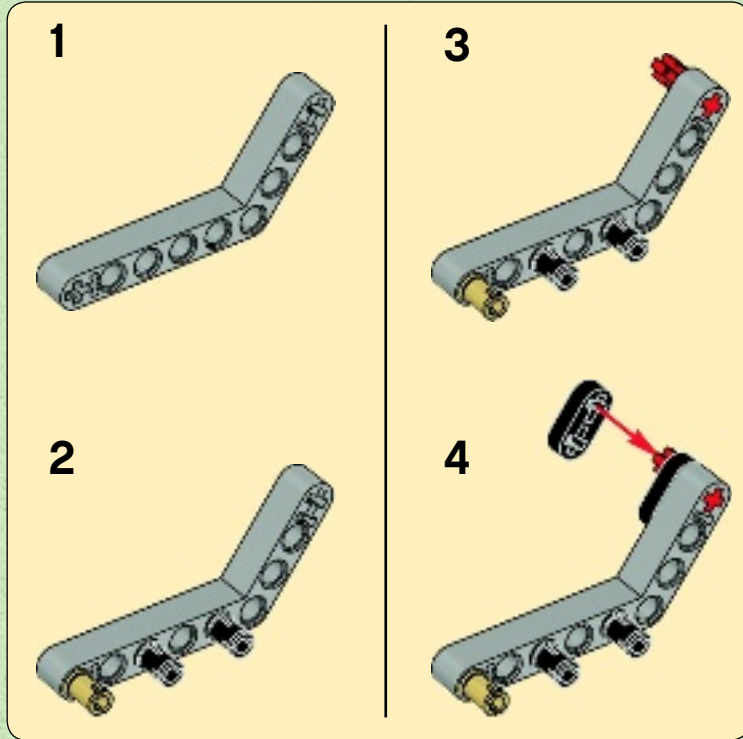

7

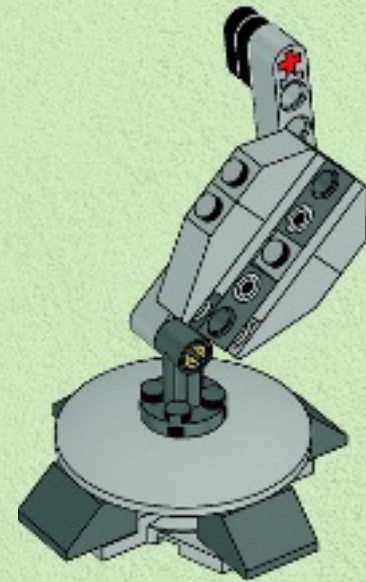

1x

1x

8

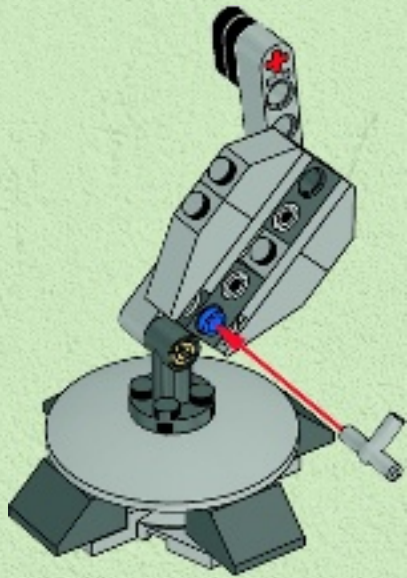

1x

9

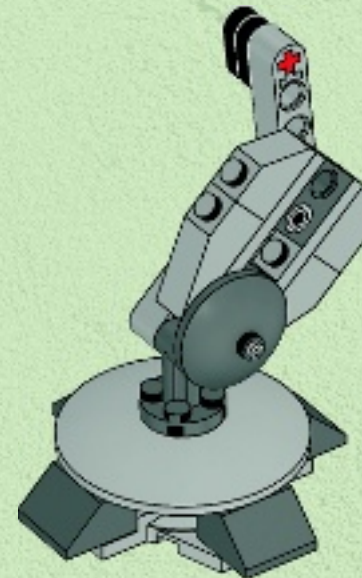

2x





35

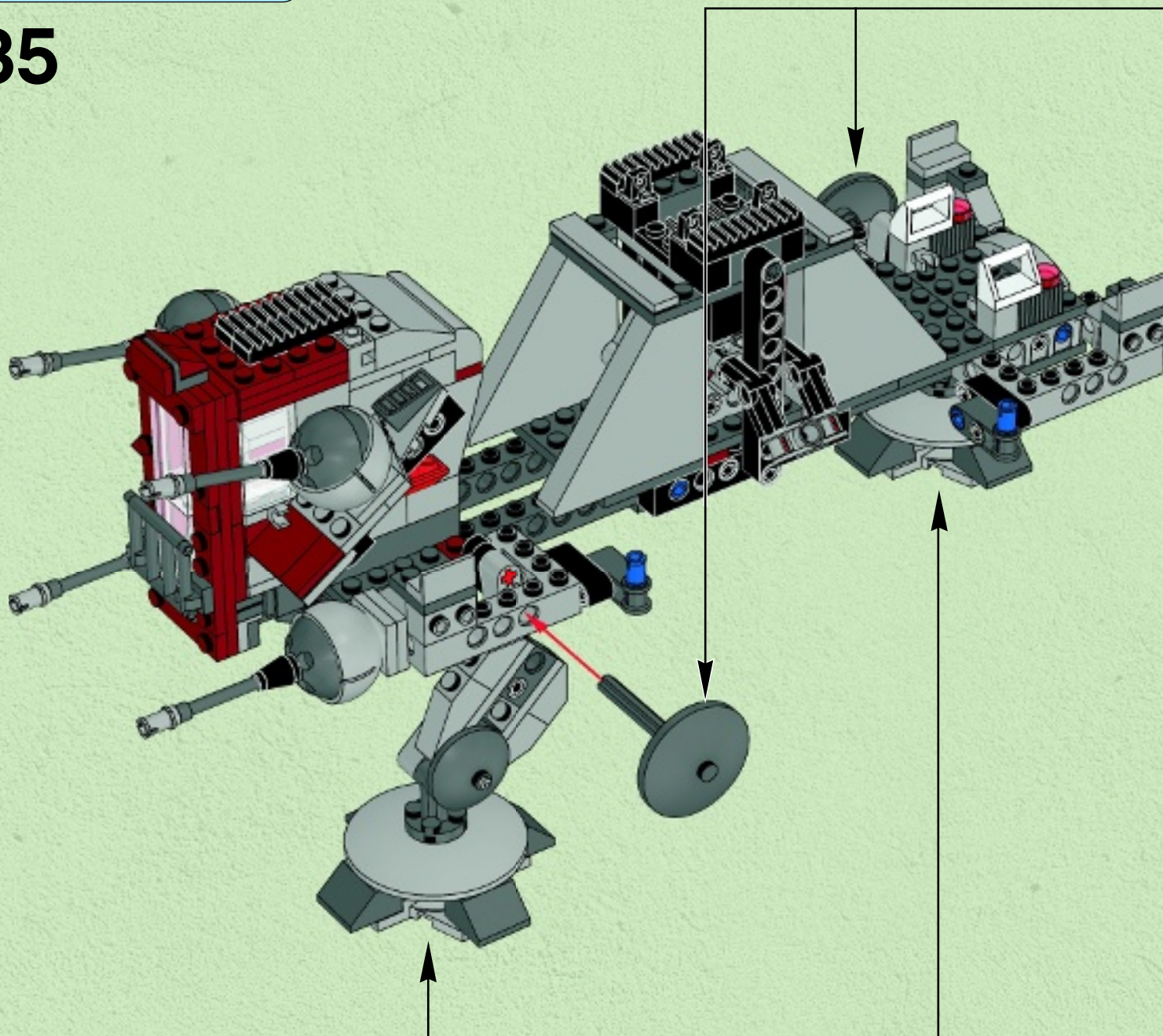
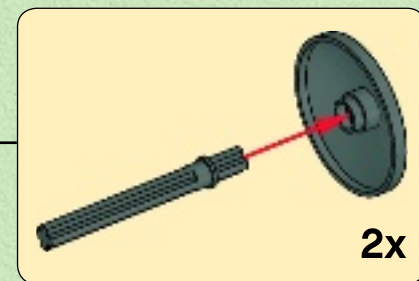

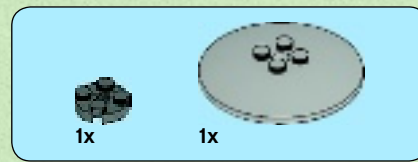
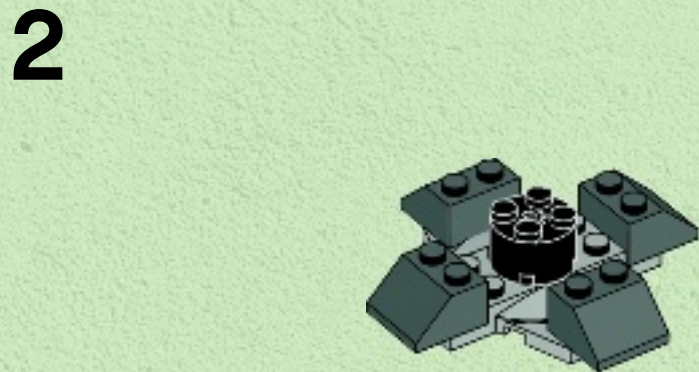
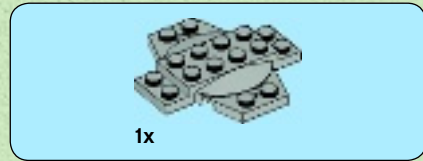

3

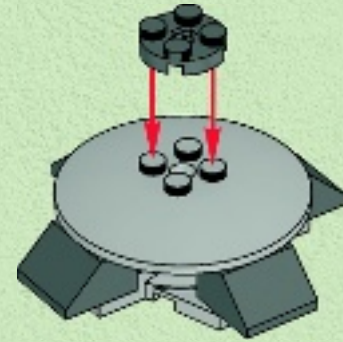

4

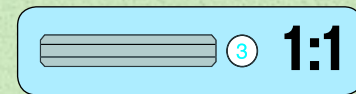
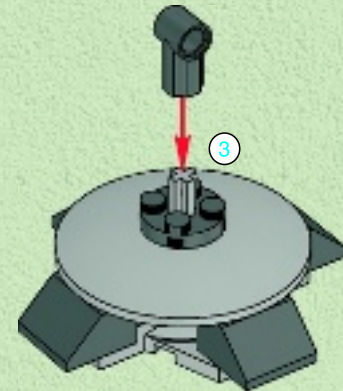

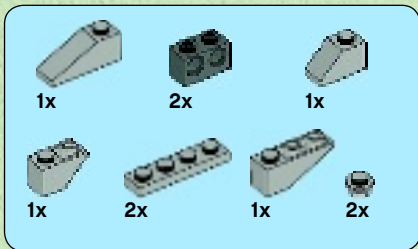

**5**

**1**

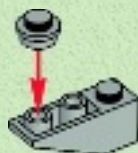

**2**

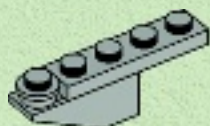

**3**

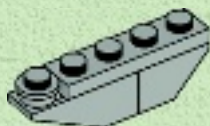

**4**

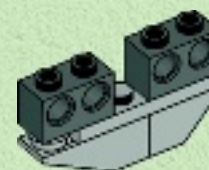

**5**

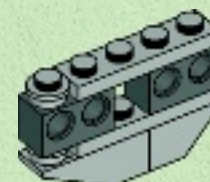

**6**

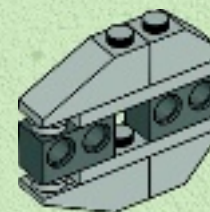

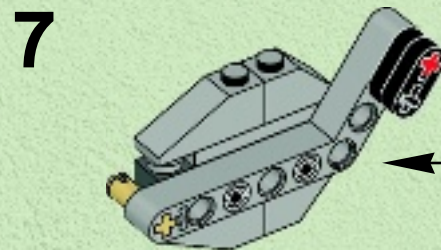
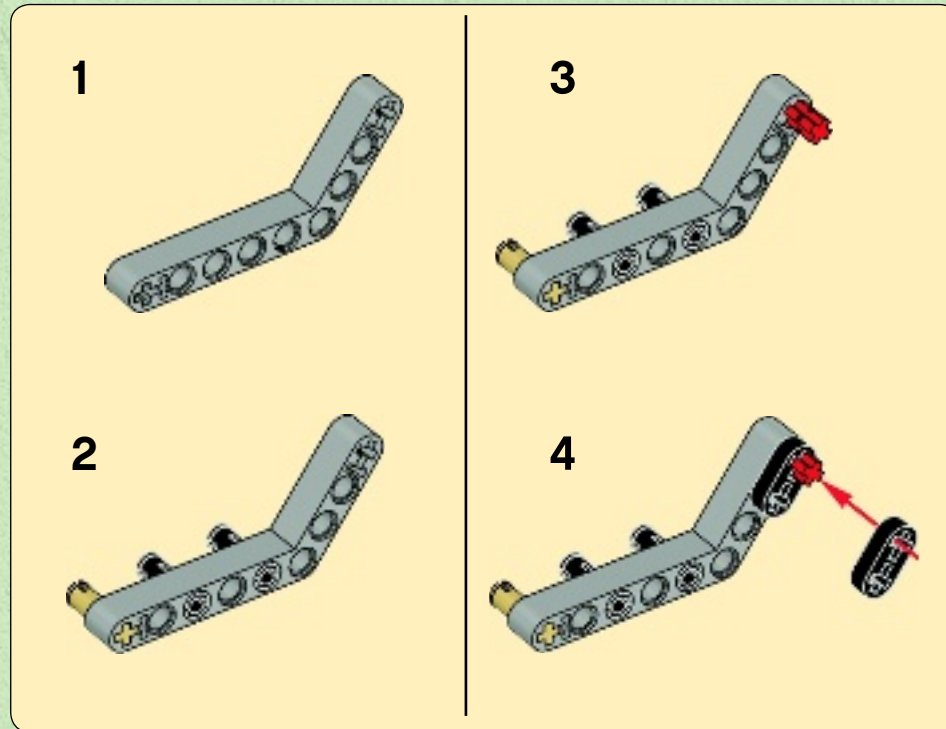
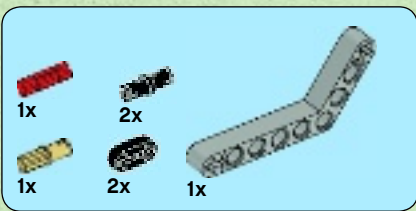

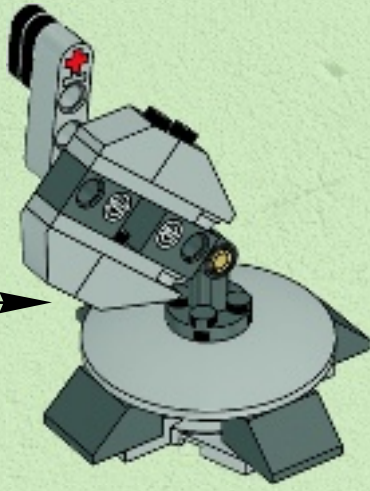

6

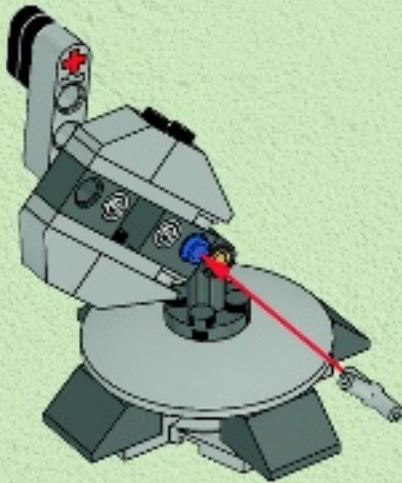

7

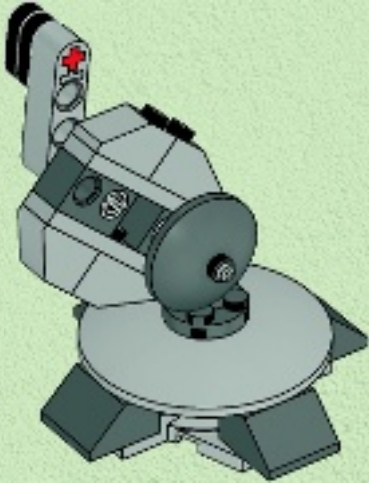

2x

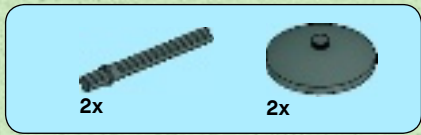

36

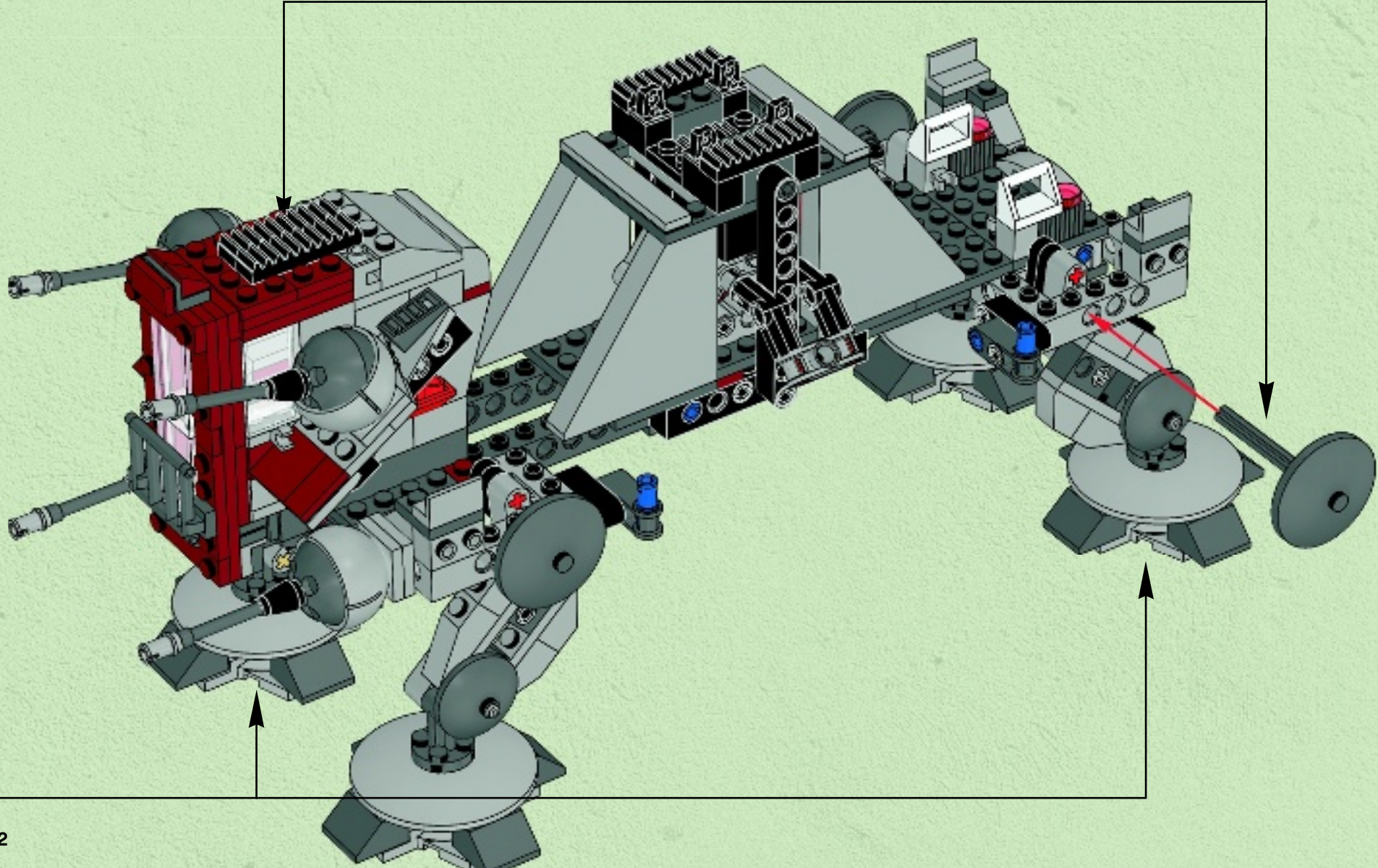
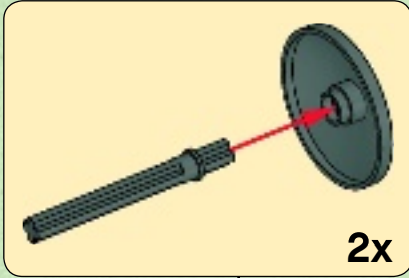



37

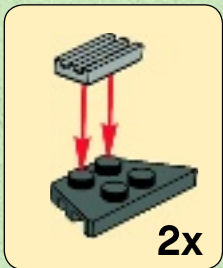
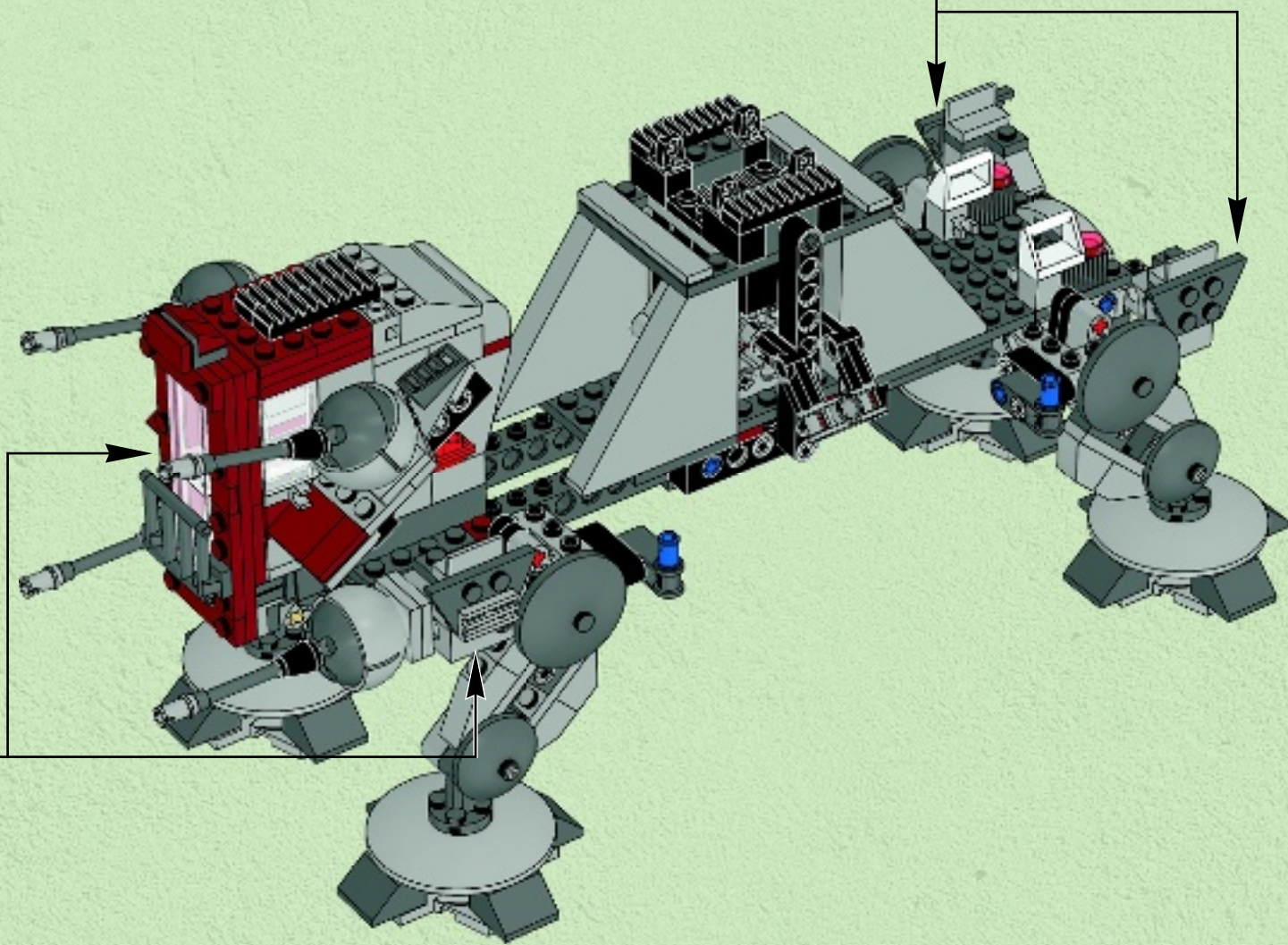



1



2

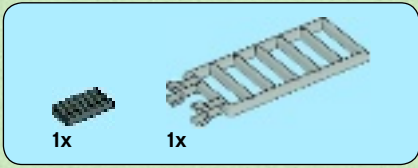
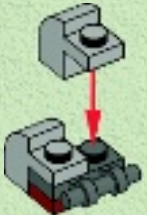

3

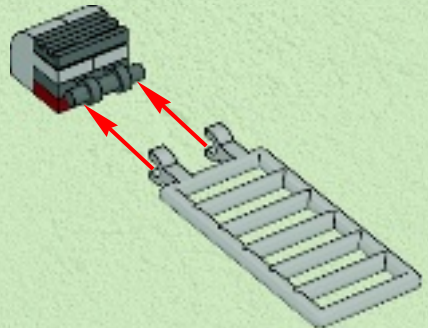

4

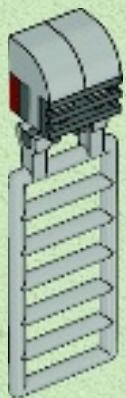
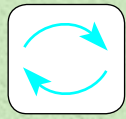



38

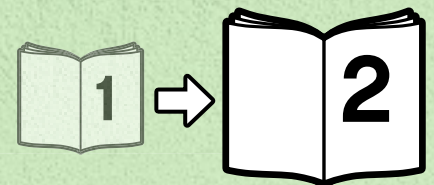
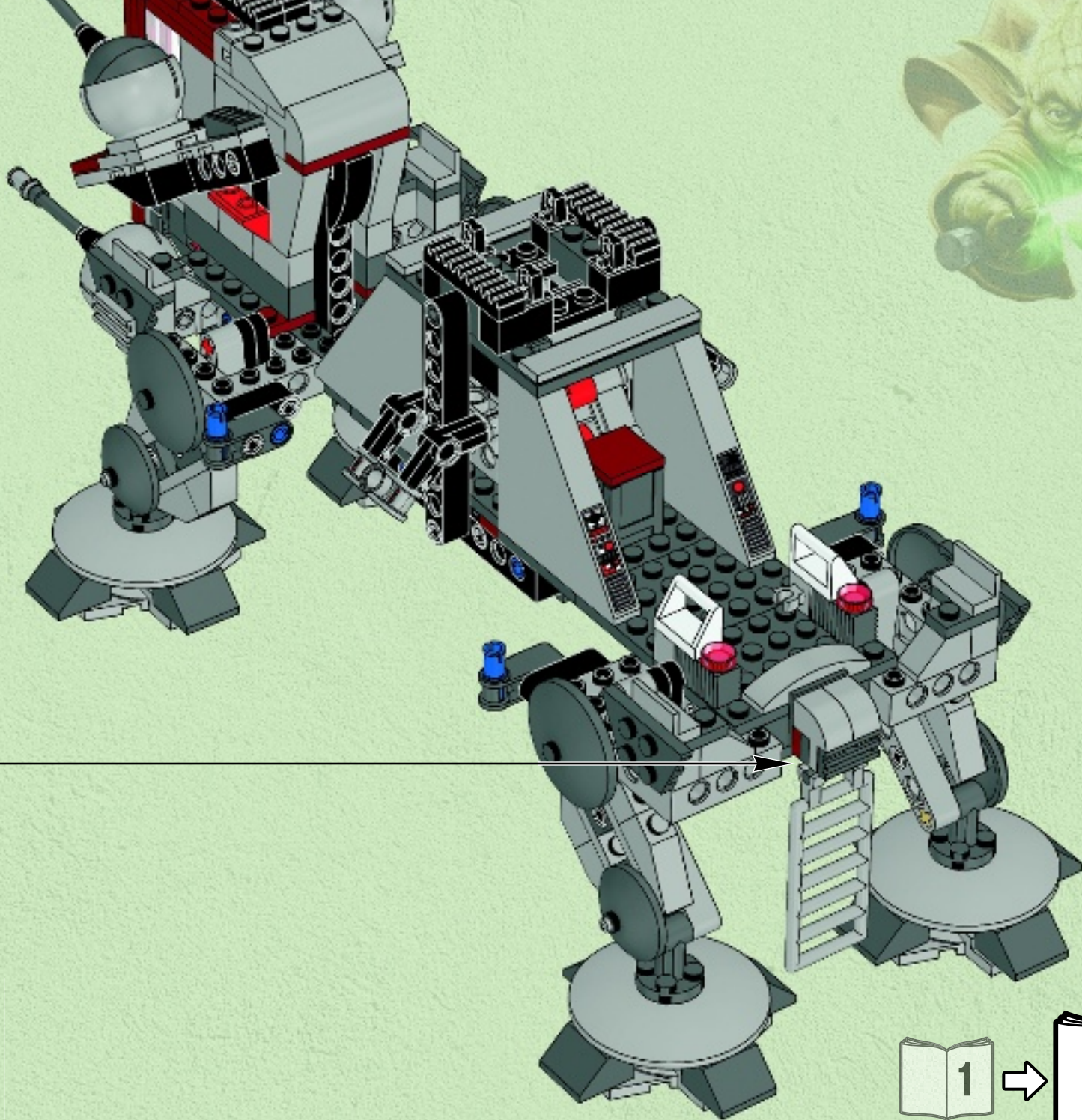



75015



75016



75017



75018



75019



75020

POSTER INSIDE



75021

POSTER INSIDE



75022

Poster inside  
Inklusive Poster  
Poster inclus

Póster en el interior  
Poster incluido  
Plakát mellékelve



LEGO.com/starwars



Internet Connection Required  
Internetverbindung erforderlich  
Connexion Internet requise  
Se requiere conexión a Internet  
Requer ligação à Internet  
Internetkapcsolat szükséges

**LEGO.com/starwars**



# WIN!

Go to [www.LEGOsurvey.com/product](http://www.LEGOsurvey.com/product) to fill out a survey for a chance to win a cool LEGO® Product.

No purchase necessary.

Open to all residents where not prohibited.



## [www.LEGOsurvey.com/product](http://www.LEGOsurvey.com/product)

### GEWINNE!

Nimm an der Umfrage auf [www.LEGOsurvey.com/product](http://www.LEGOsurvey.com/product) teil und hab die Chance ein cooles LEGO® Produkt zu gewinnen!

Die Teilnahme am Gewinnspiel führt zu keinerlei Kaufverpflichtungen. Teilnahme in allen nicht ausgeschlossenen Ländern möglich.

### WIN!

Ga naar [www.LEGOsurvey.com/product](http://www.LEGOsurvey.com/product), vul een enquêteformulier in en maak kans op een cool LEGO® product.

Geen aankoopverplichting. Iedereen mag deelnemen, uitgezonderd ingezetenden van landen waar een enquêteverbod geldt.

### GAGNE!

Visite [www.LEGOsurvey.com/product](http://www.LEGOsurvey.com/product) pour répondre à un questionnaire et avoir une chance de gagner un produit LEGO® très cool!

Aucune obligation d'achat. Ouvert à tous les résidents des pays autorisés.

### 当てよう!

[www.LEGOsurvey.com/product](http://www.LEGOsurvey.com/product) にアクセスして、アンケートにご記入ください。当選者にはレゴ製品を差し上げます。

お買い上げの必要はありません。禁止されていない限り、すべての皆様にご利用いただけます。