

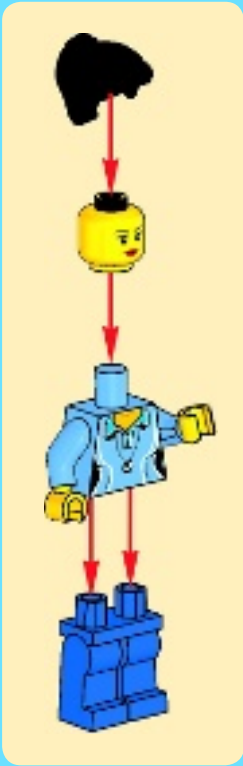

CREATOR

31026





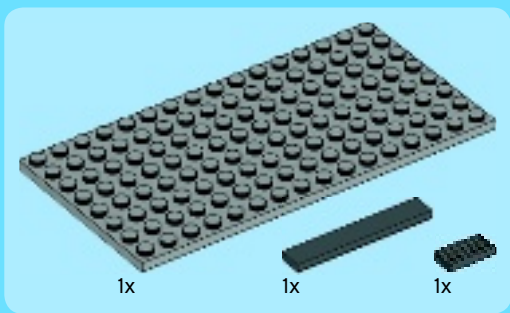

1

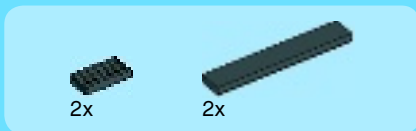
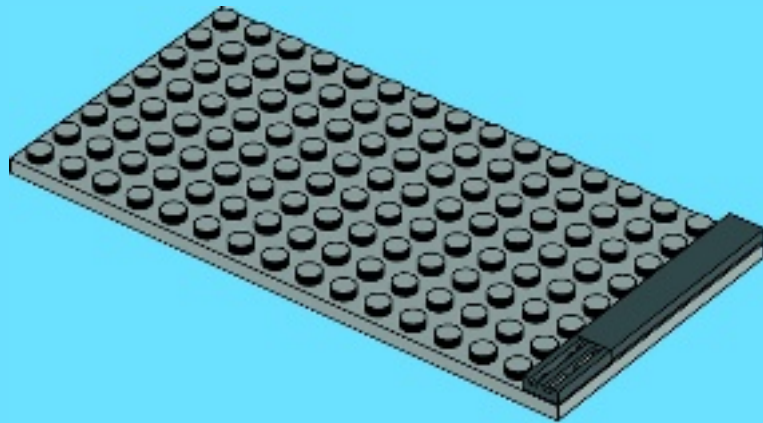

2

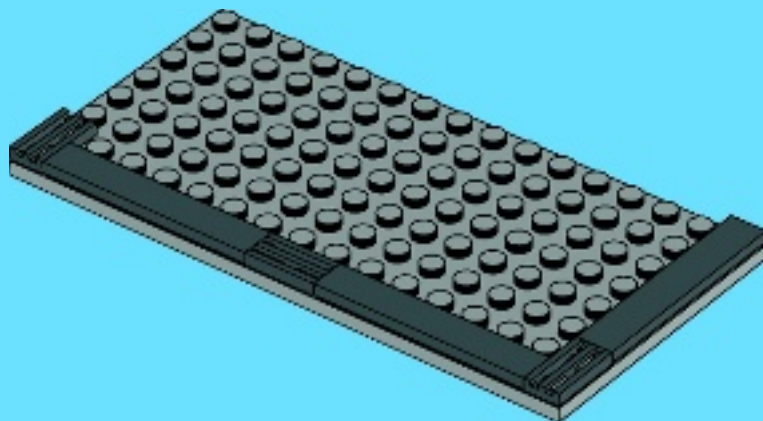

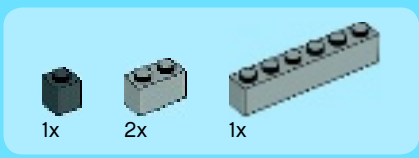

3

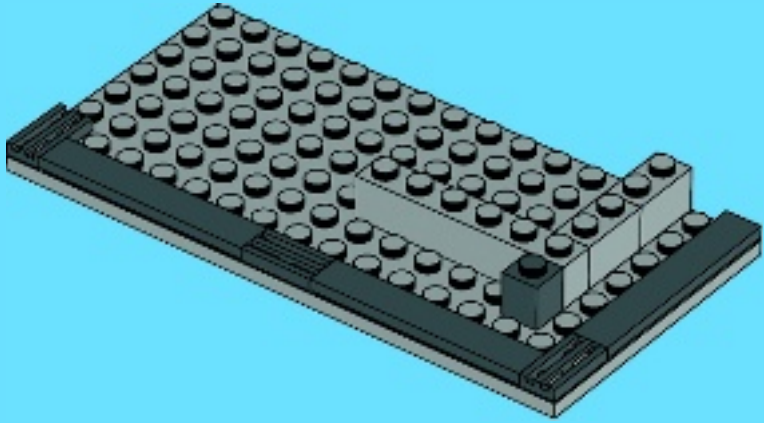

1x



1x



2x

4

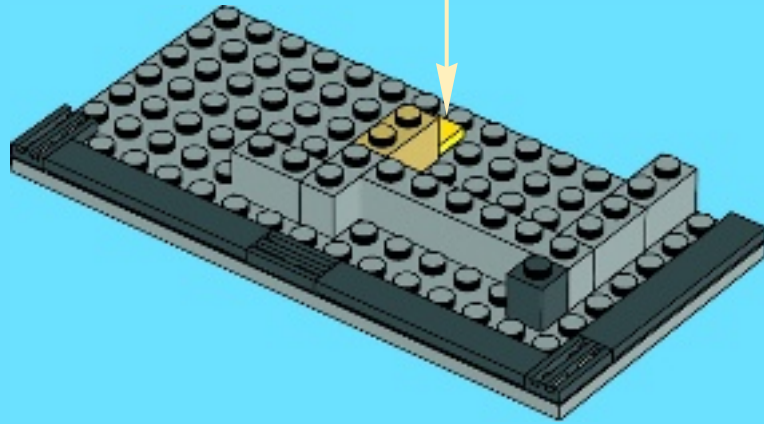

1x



1x

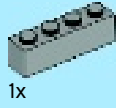

1x

5

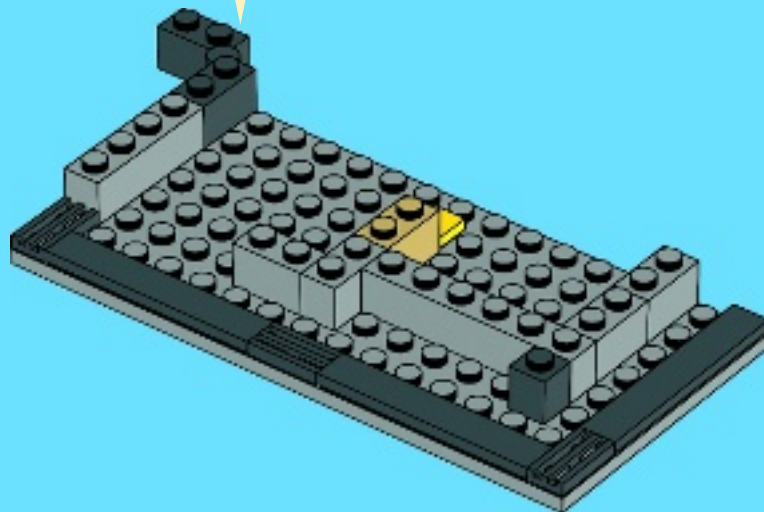
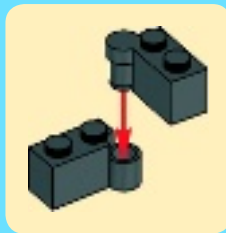

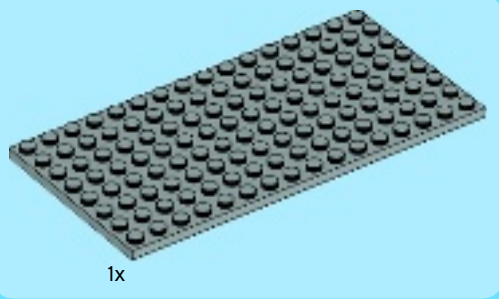

6

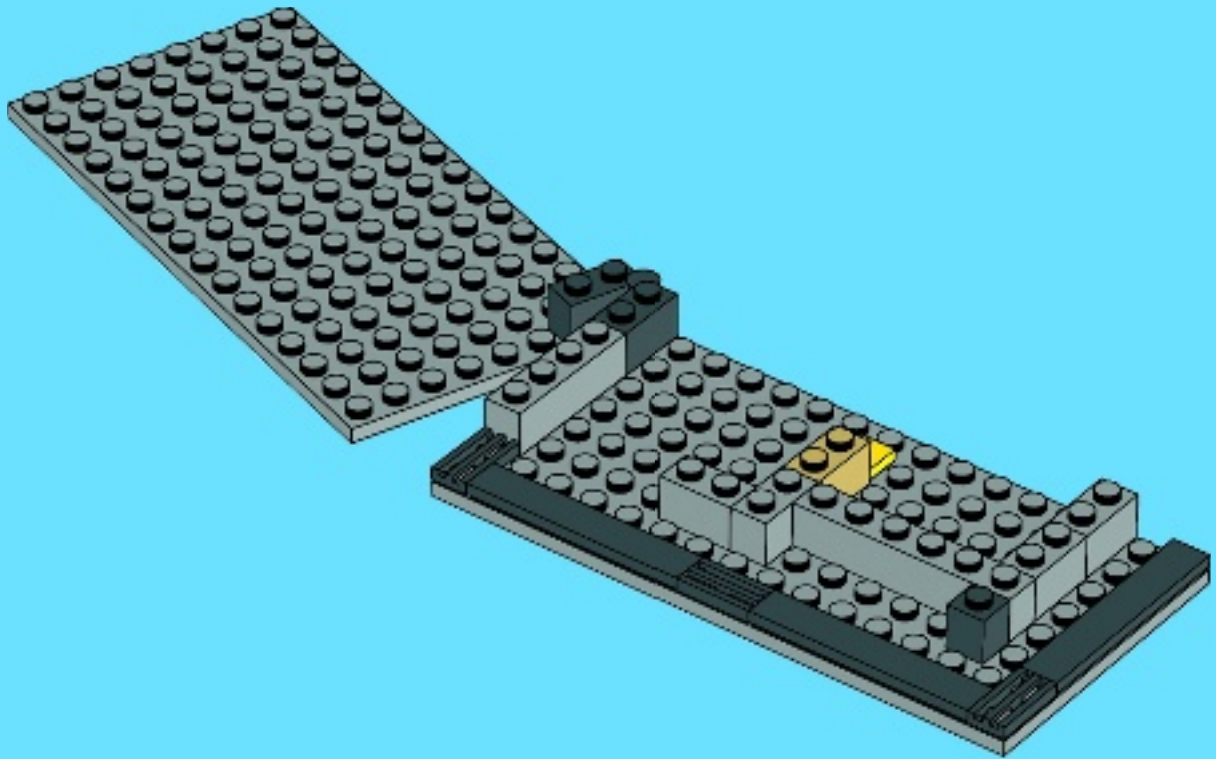



7

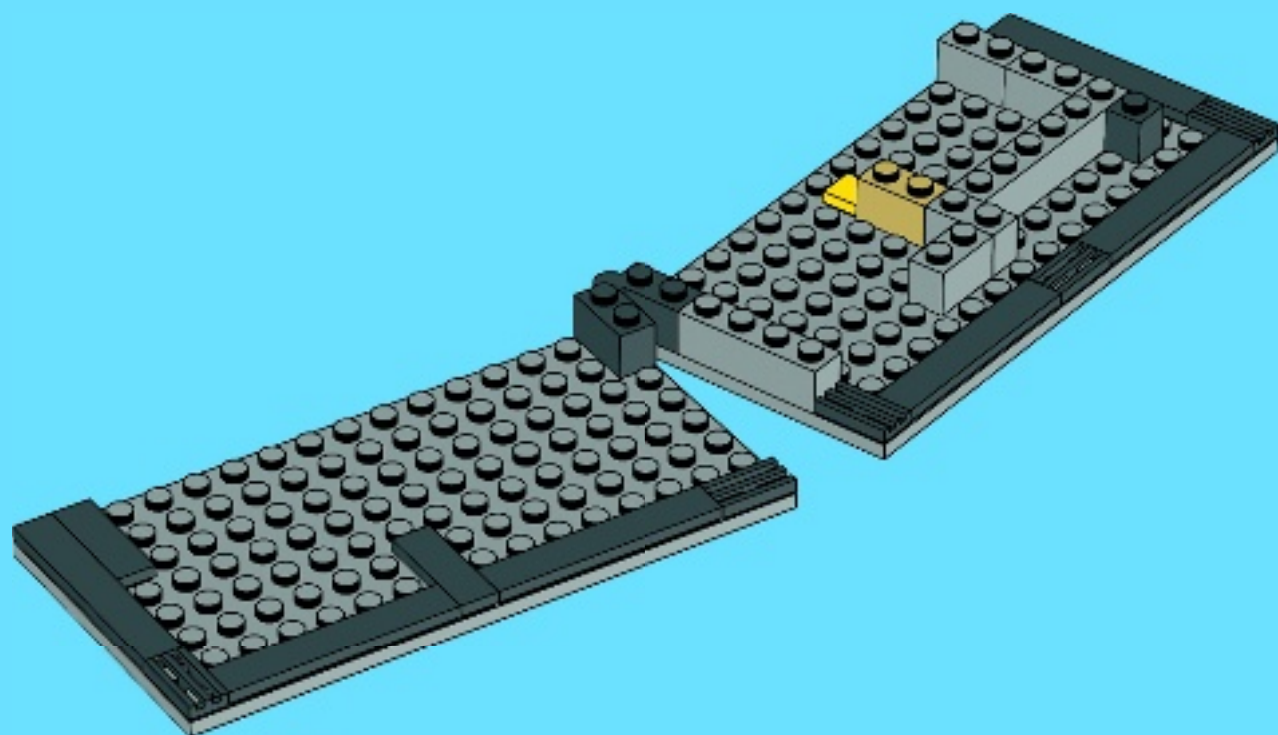



1x



2x



1x



2x

8

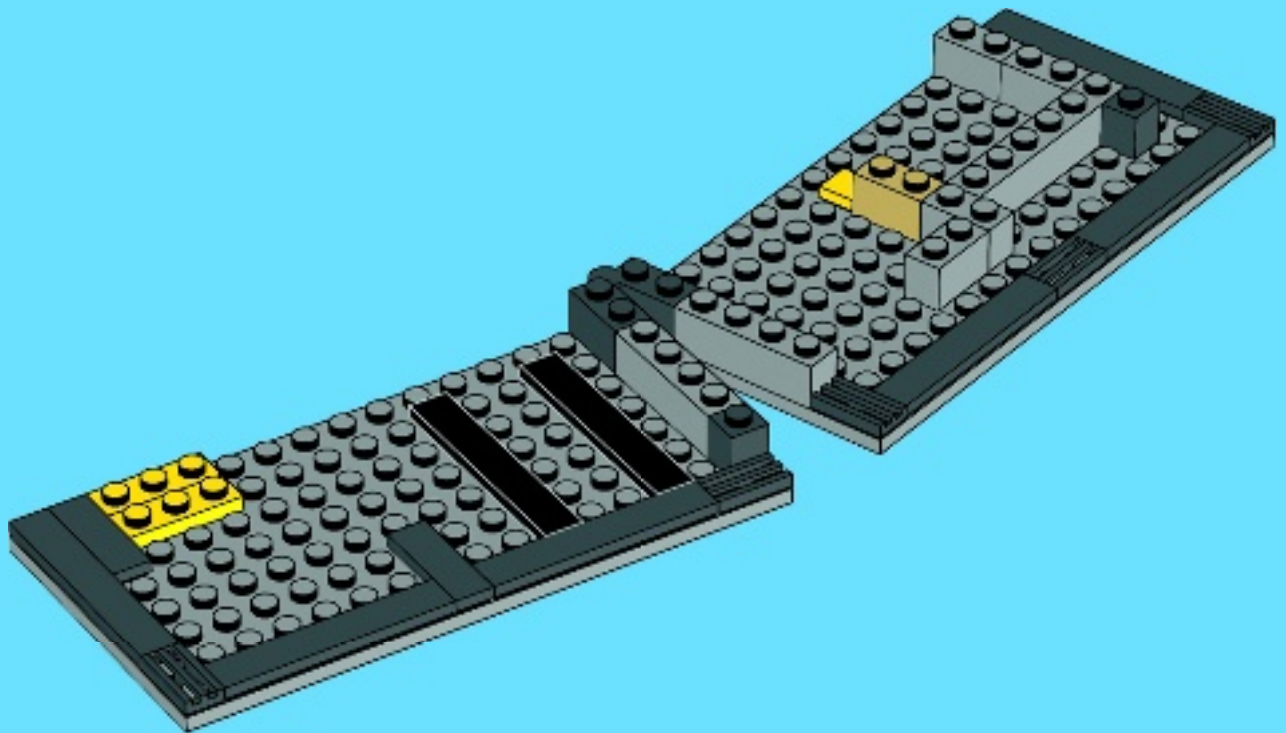



1x



1x



6x



2x

9

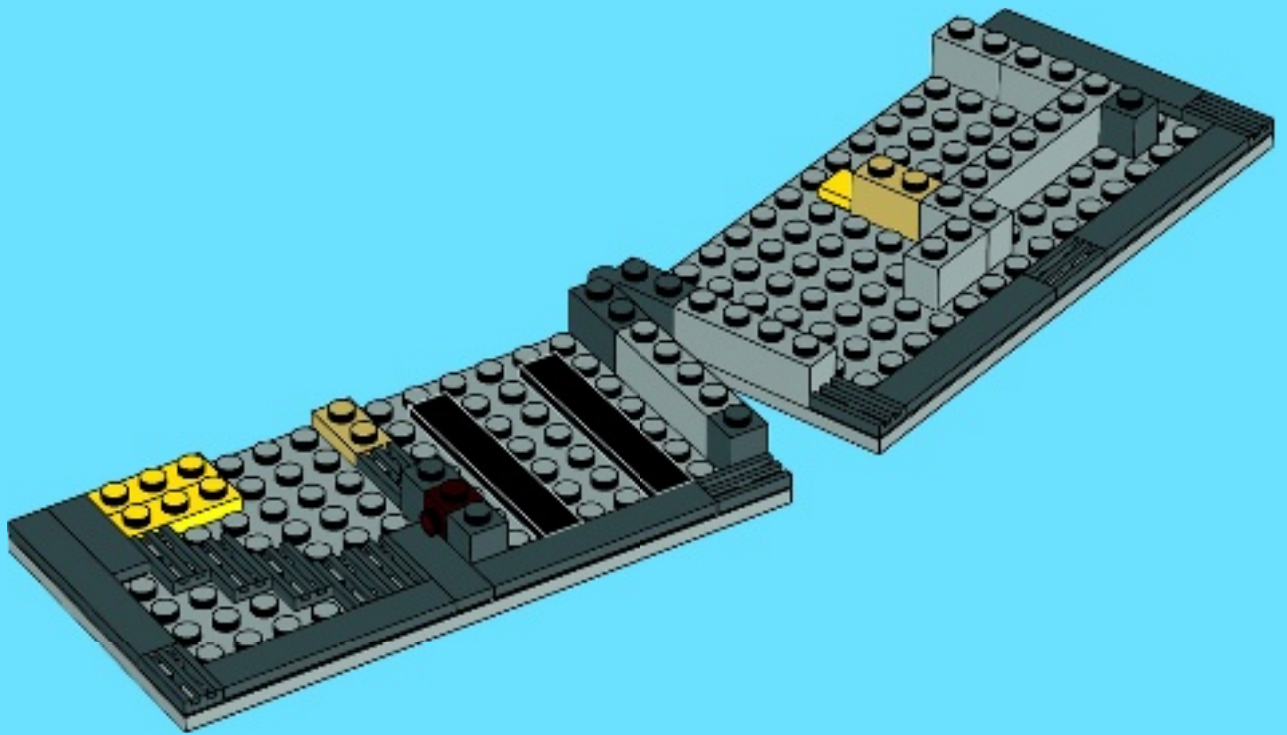



1x



1x



3x

10

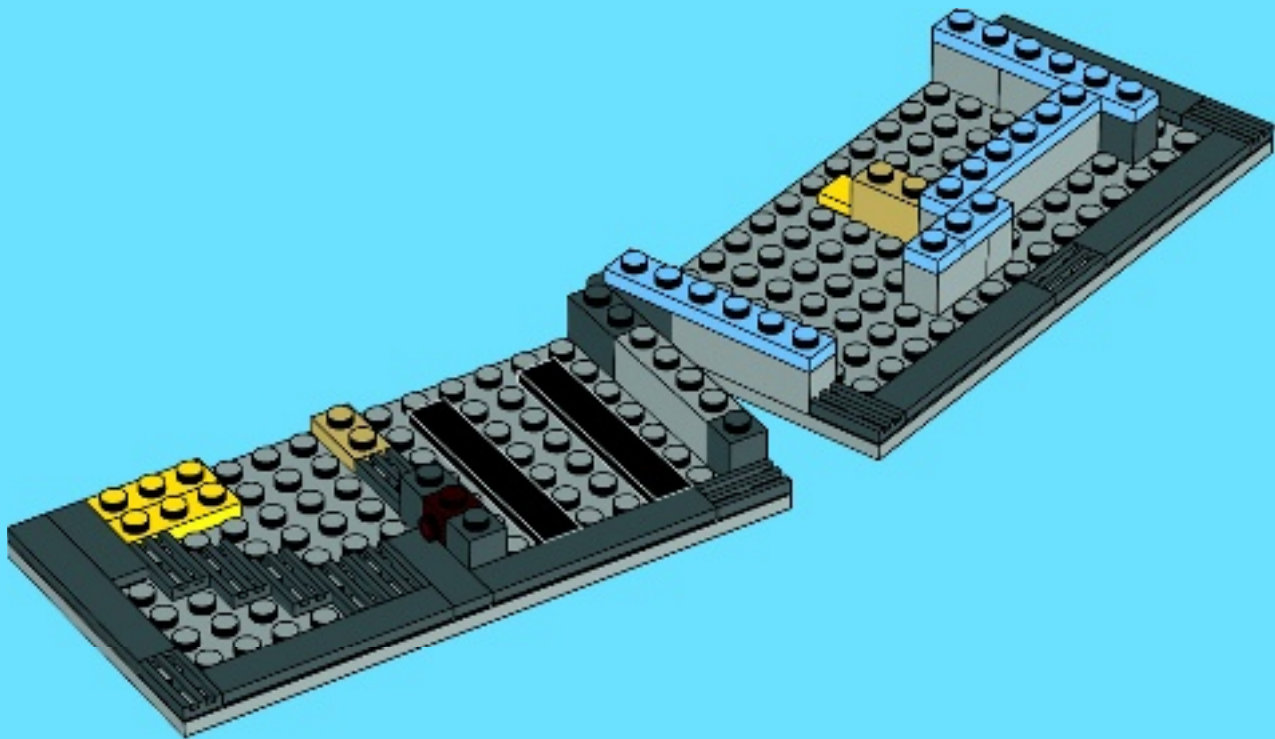

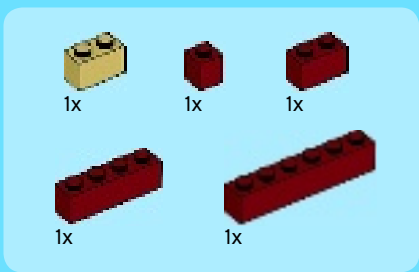

12

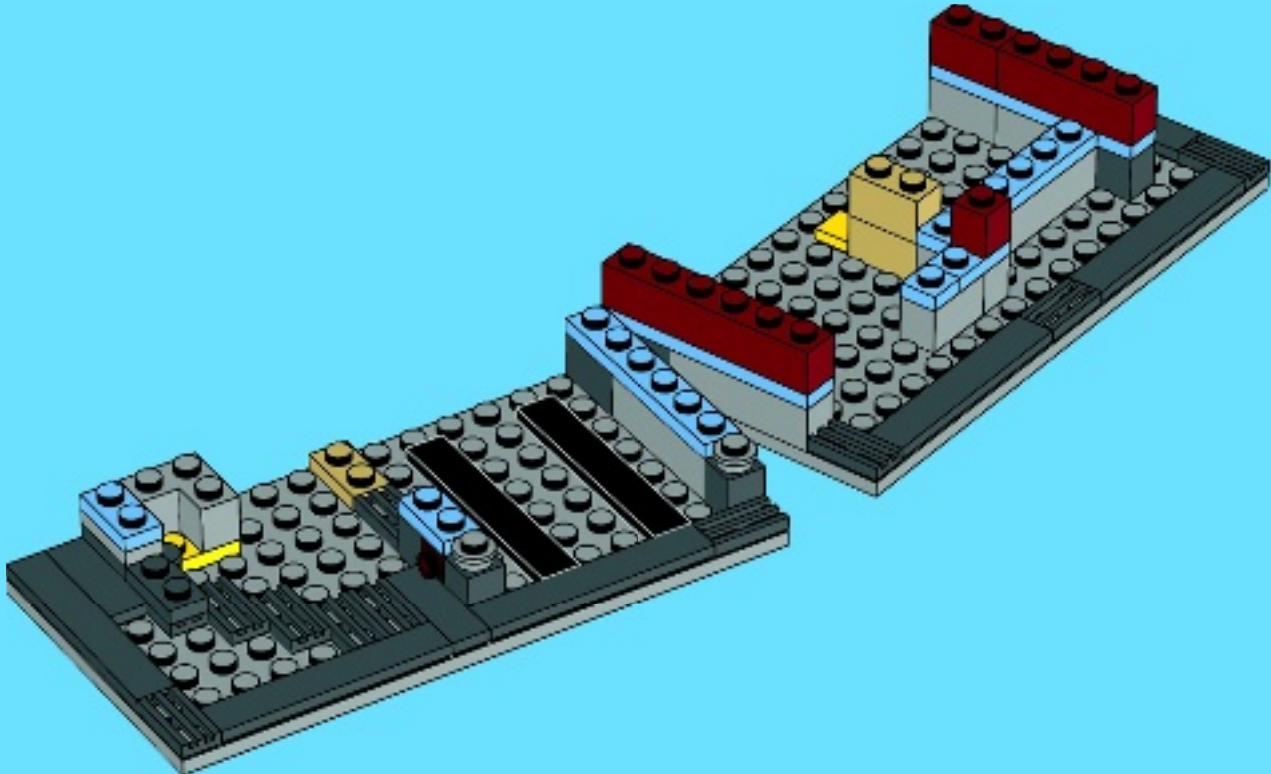



2x



2x



1x



1x

13

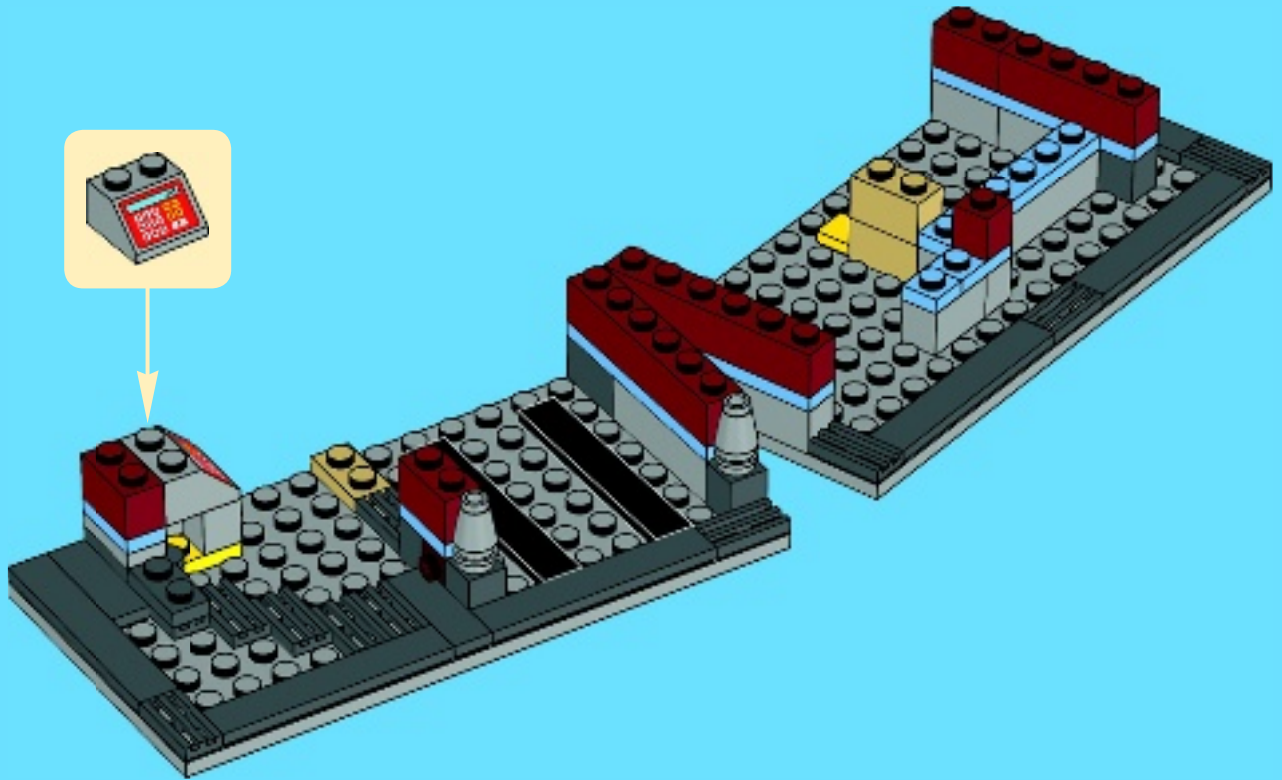



2x



1x



3x



1x

14

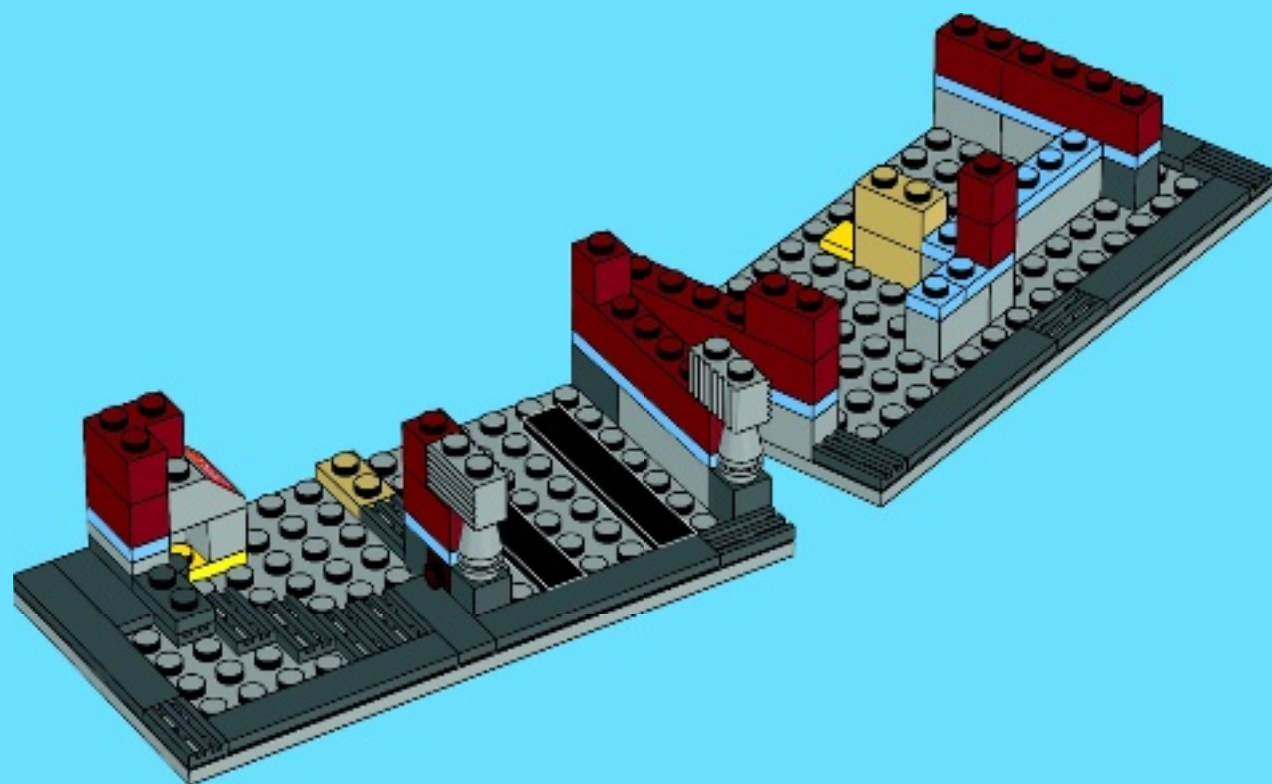

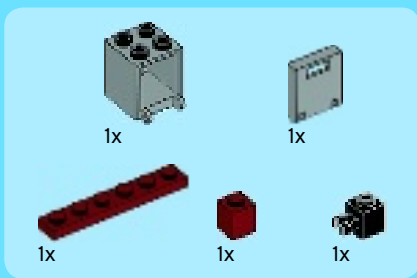

15

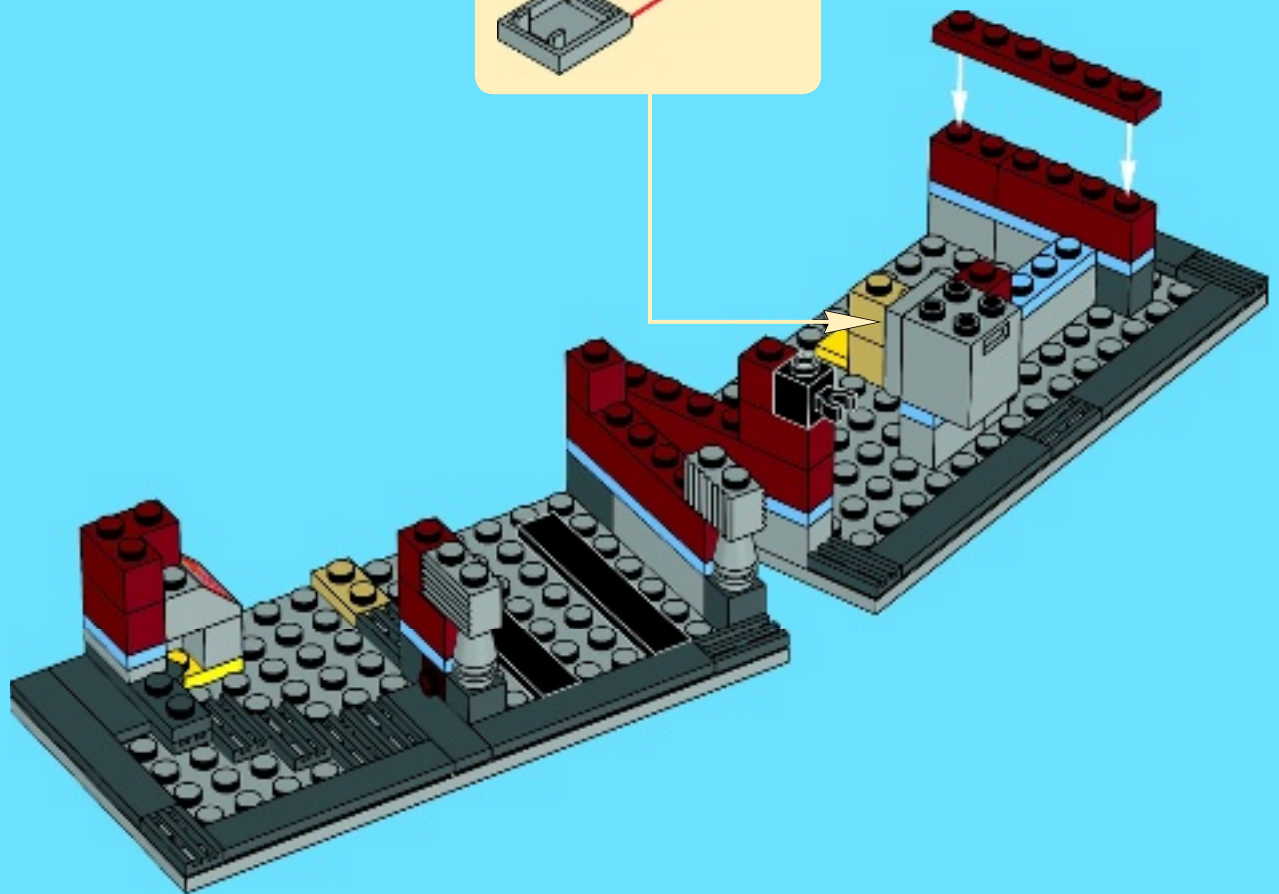
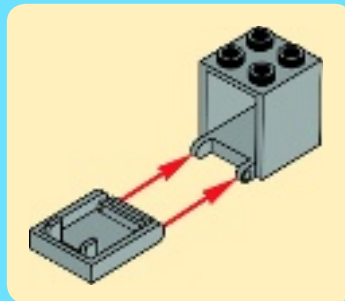

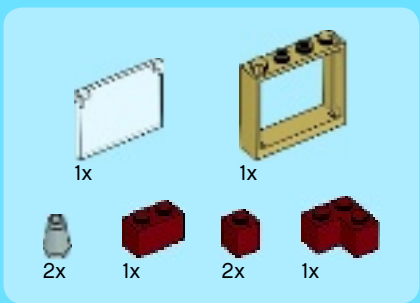

16

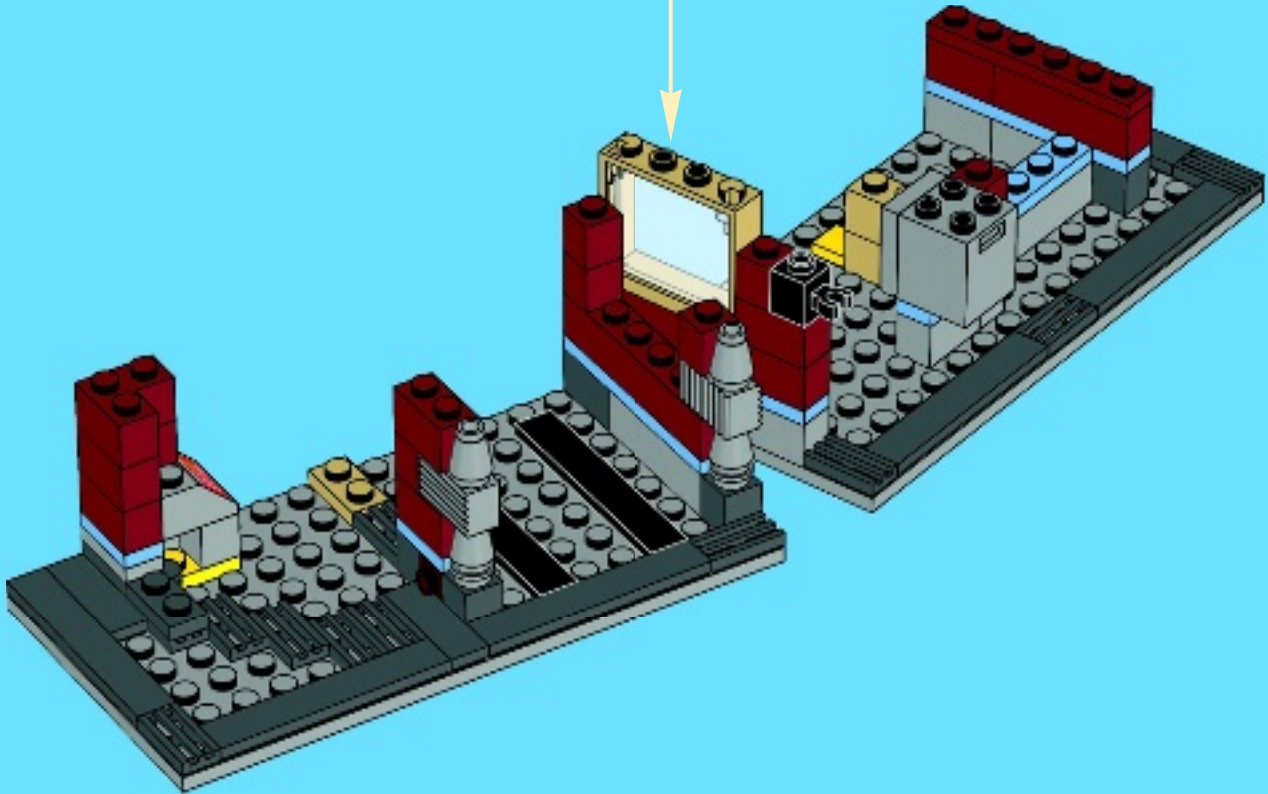
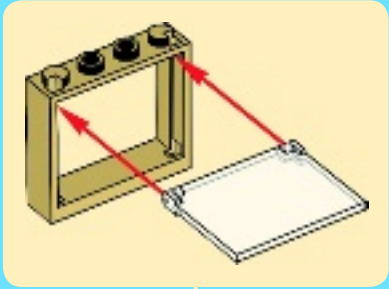

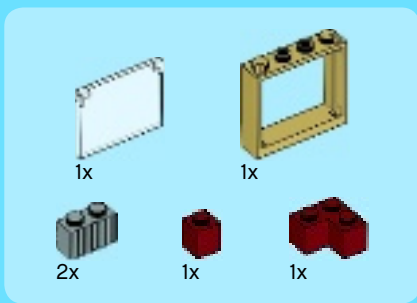

17

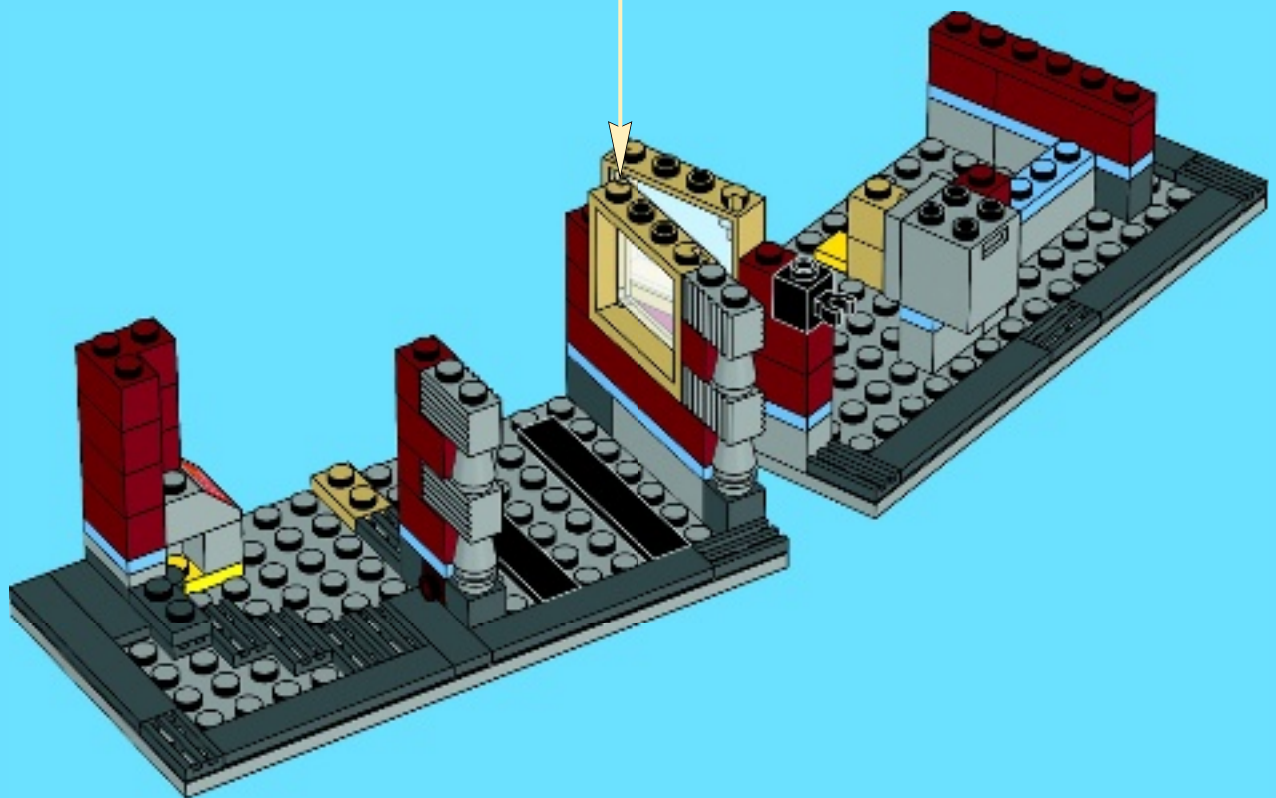
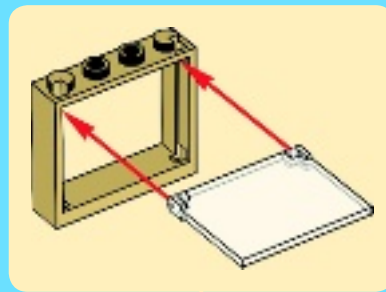



1x









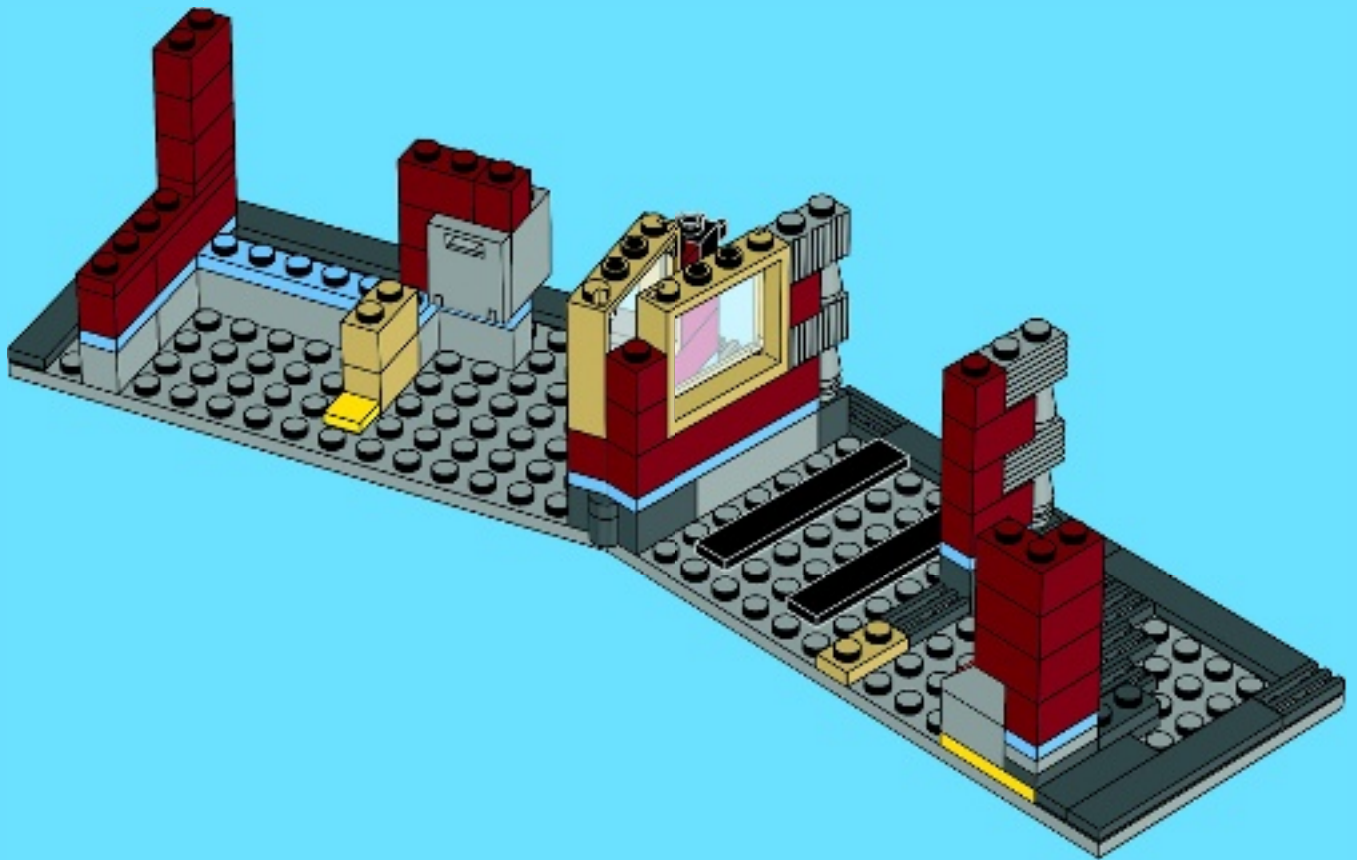
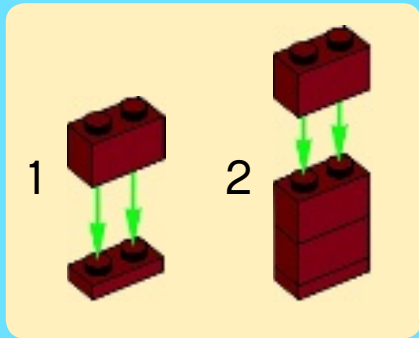

1x



4x

18



- 1x 
- 3x 
- 1x 
- 1x 
- 1x 
- 1x 
- 1x 
- 1x 

20

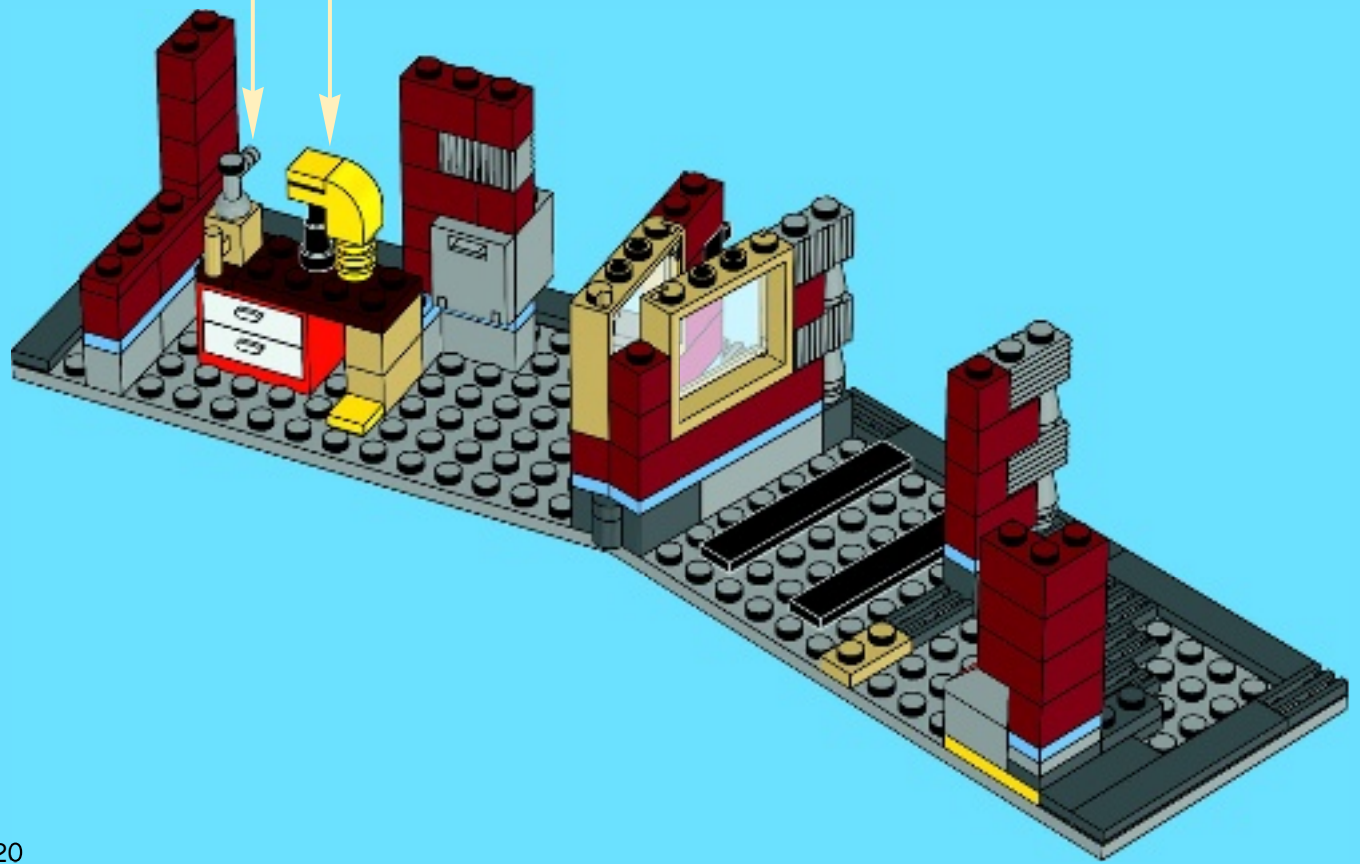
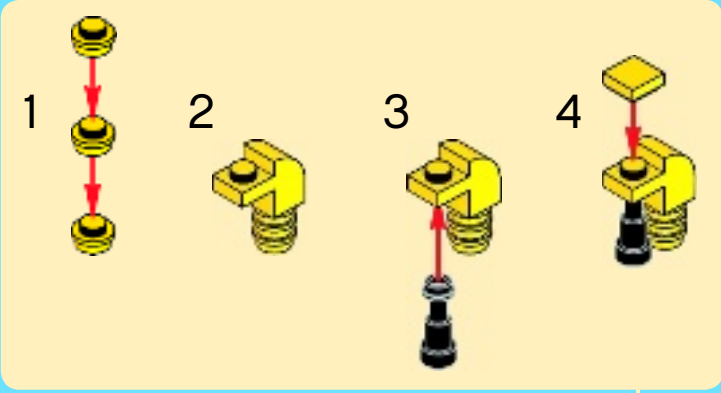
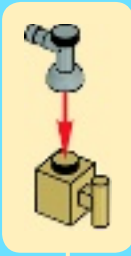

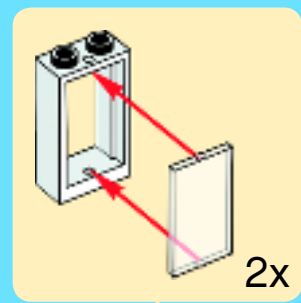
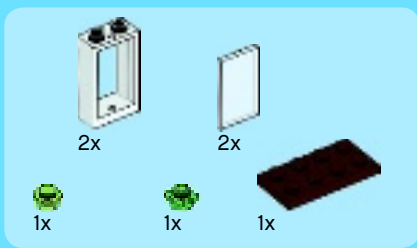

21

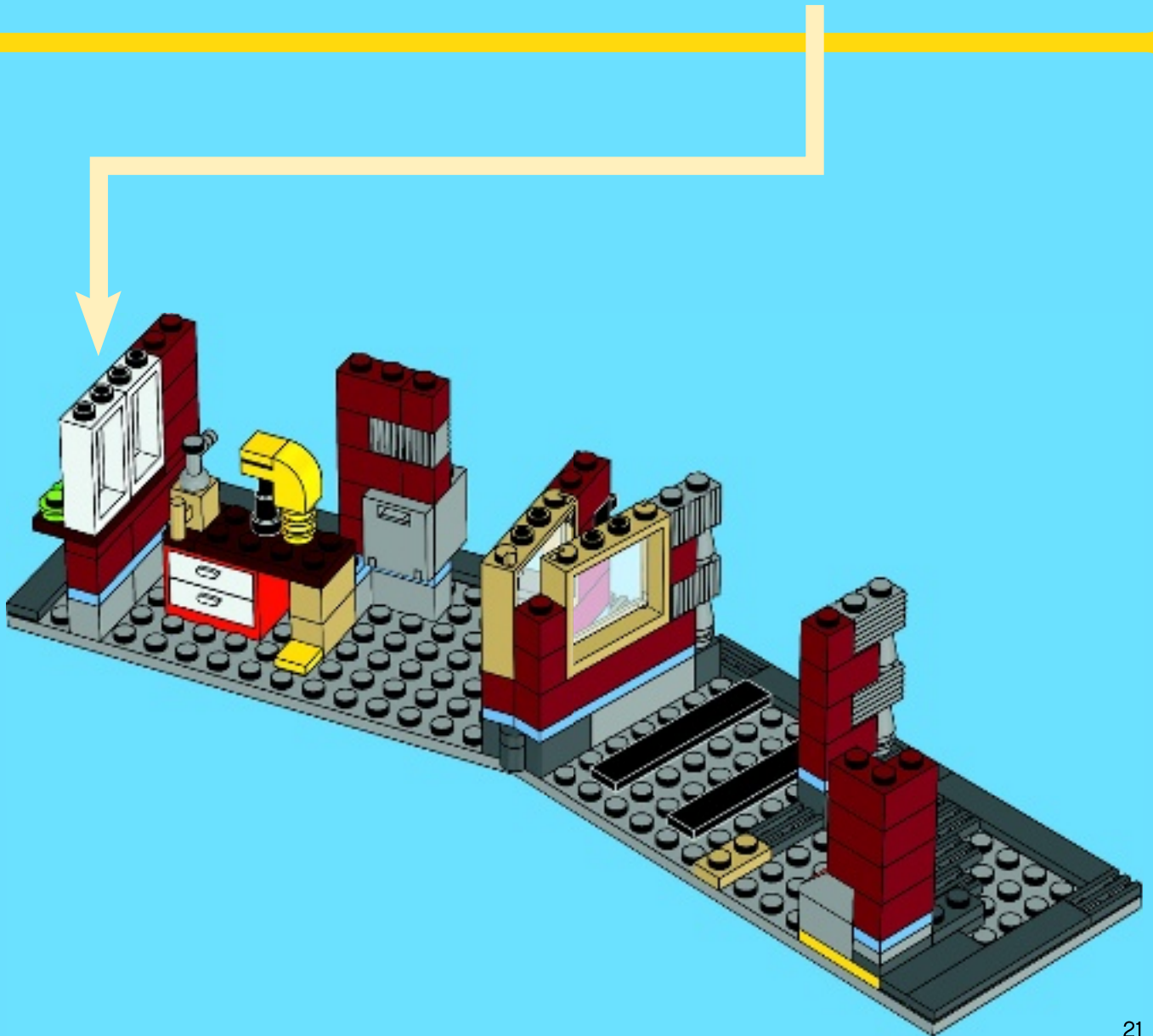
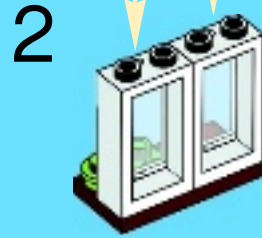

22

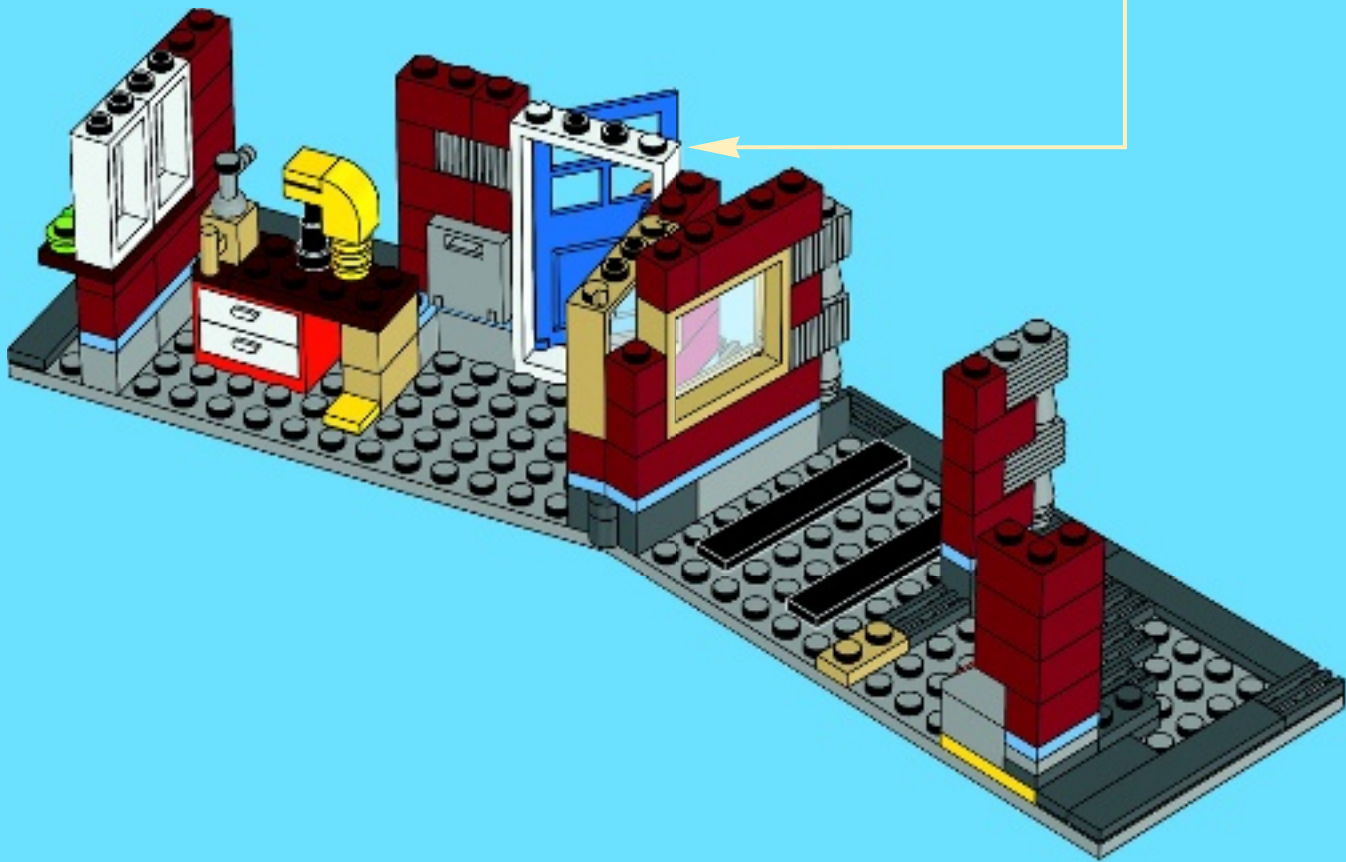
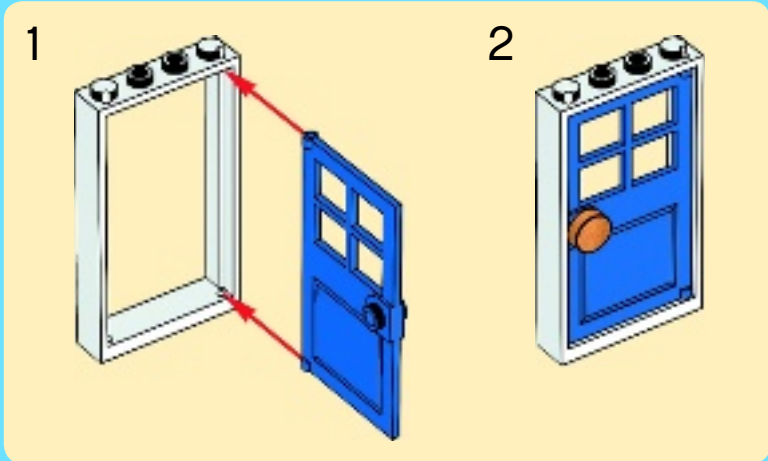
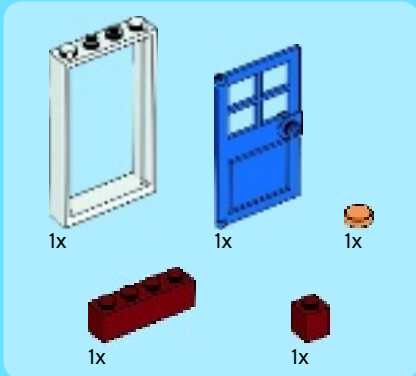

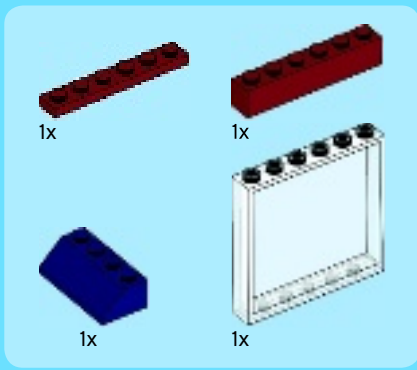

23

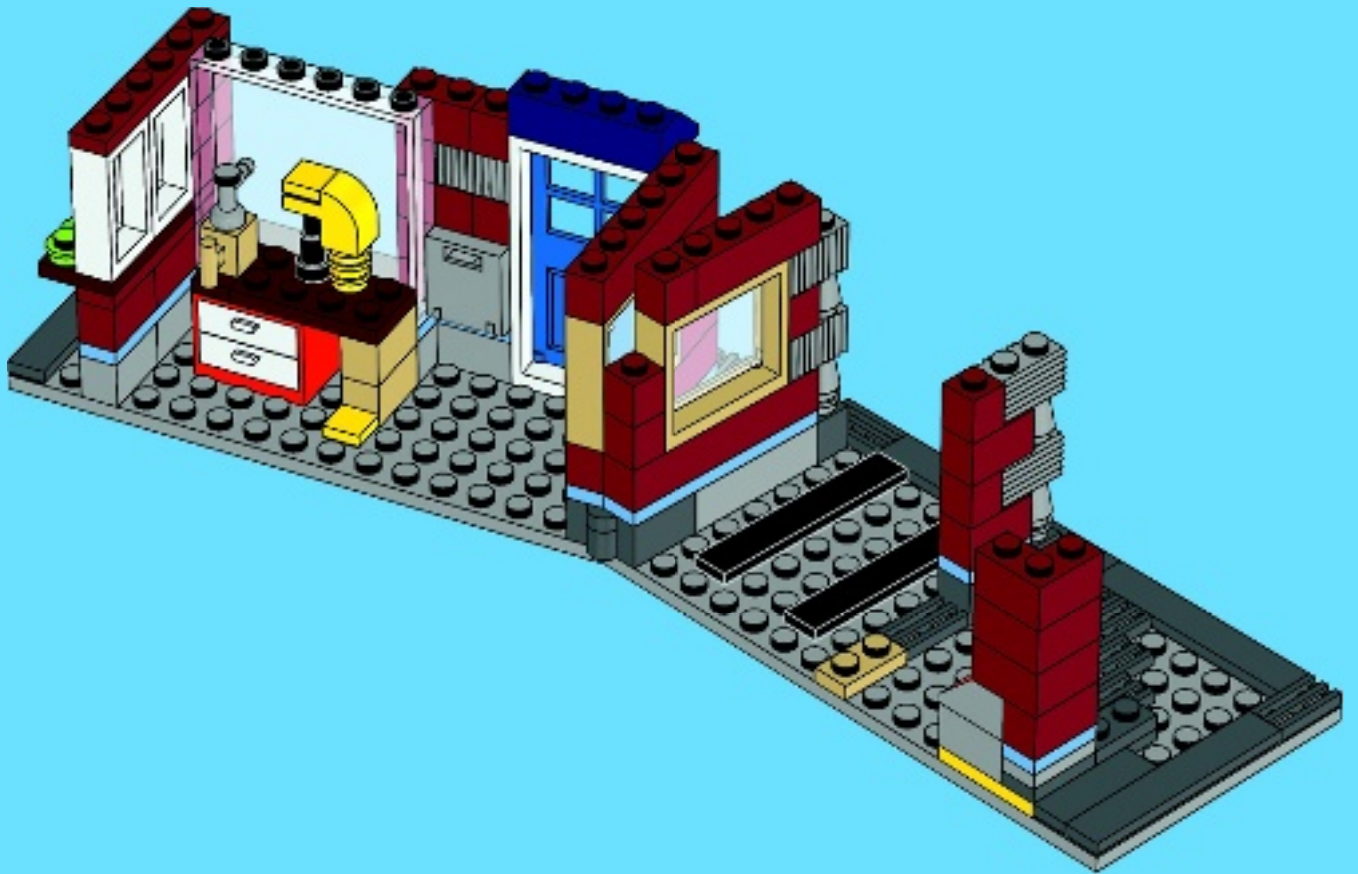

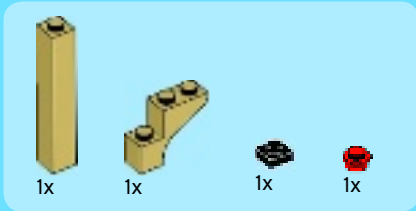

24

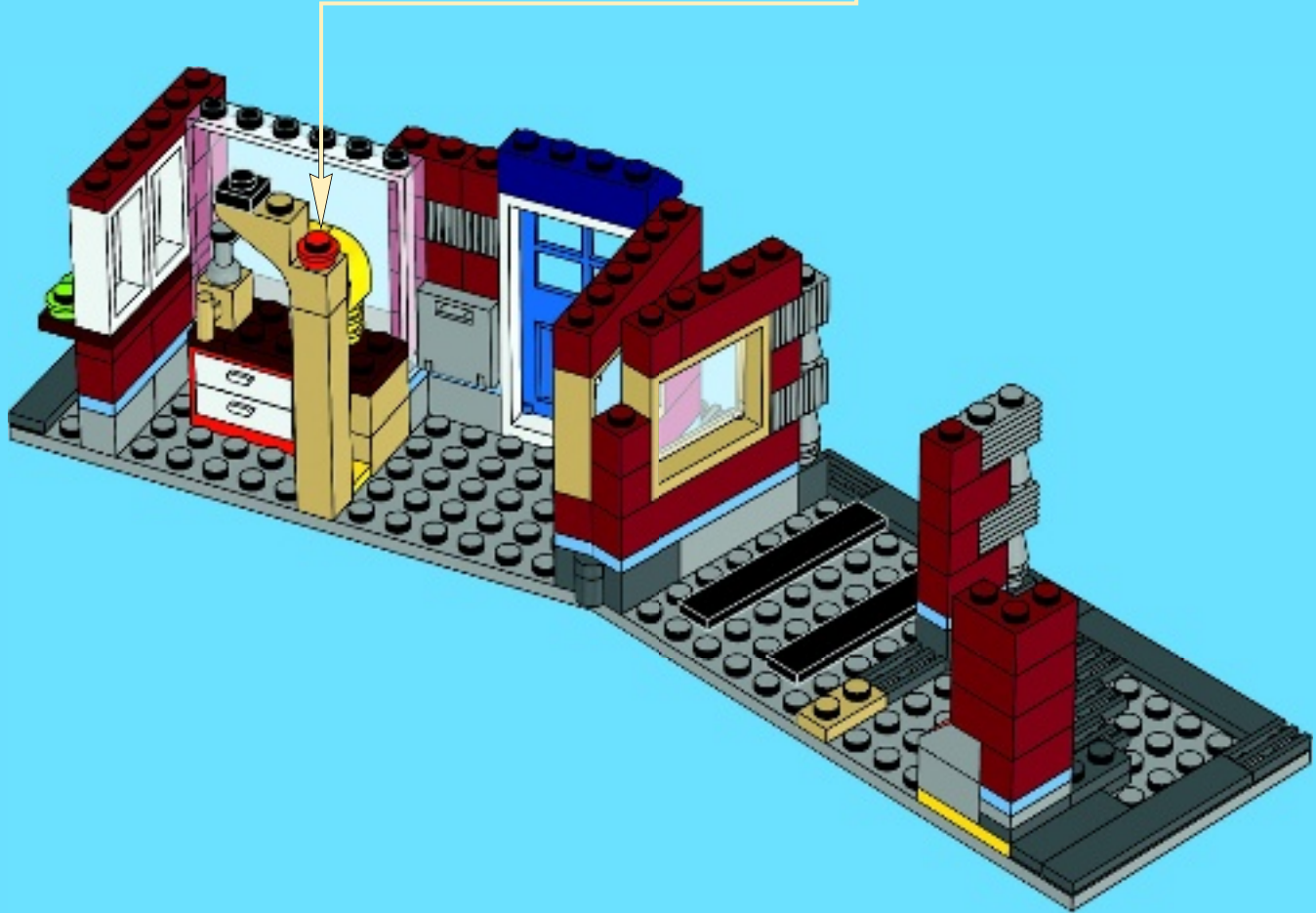
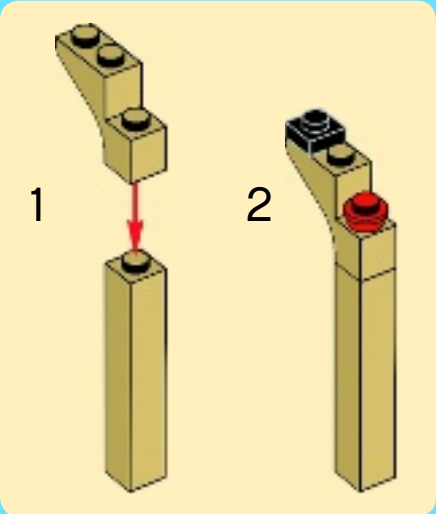

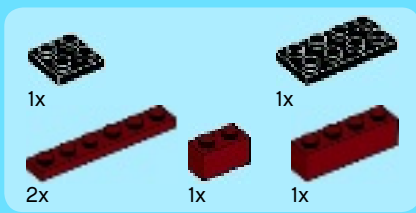

25

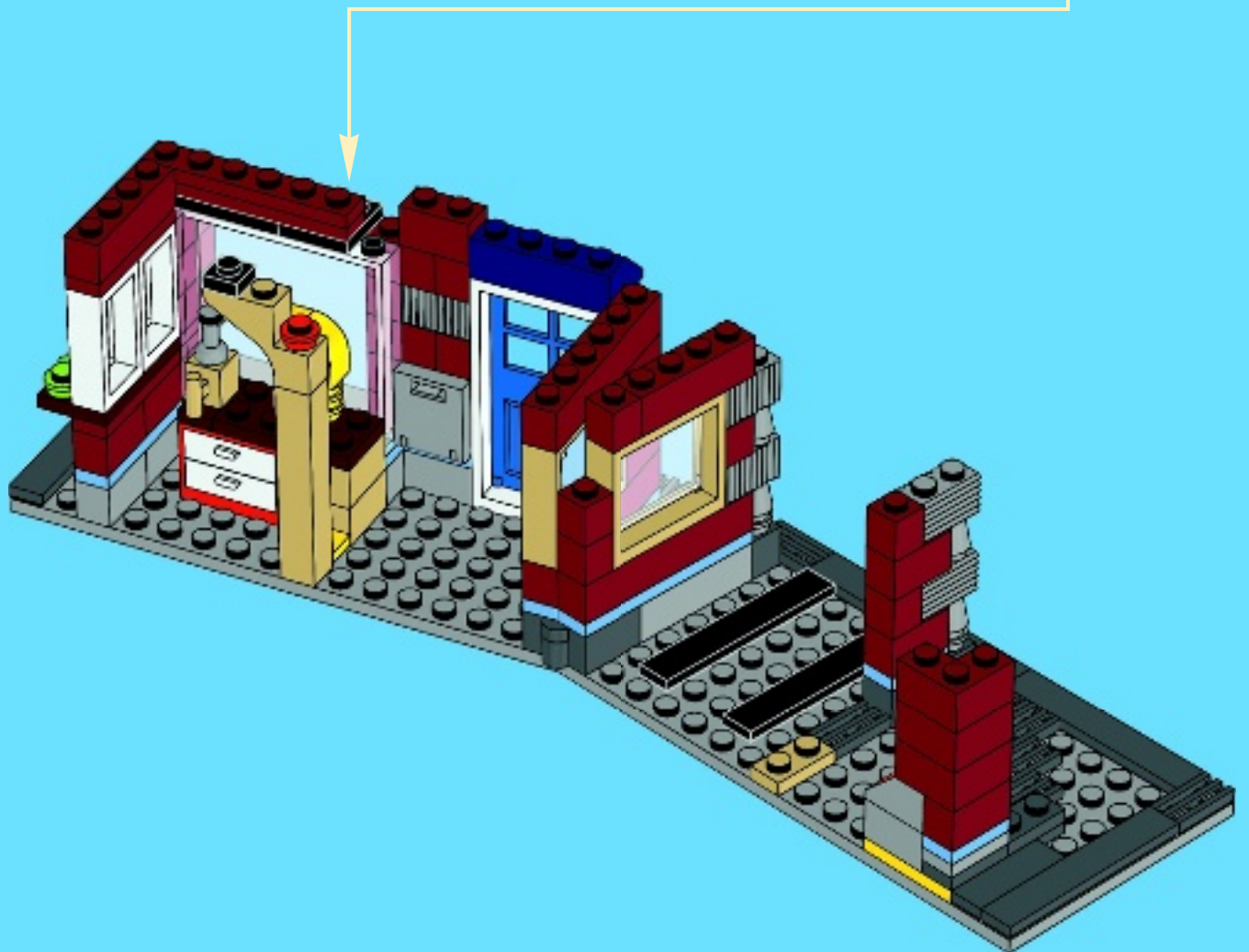
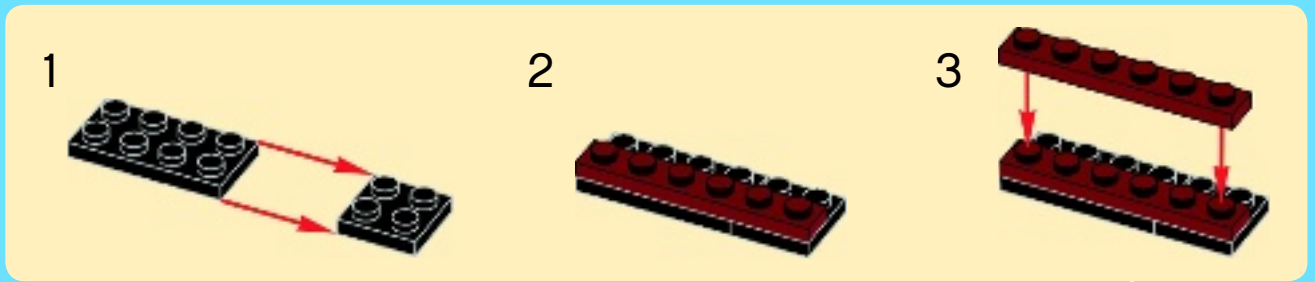

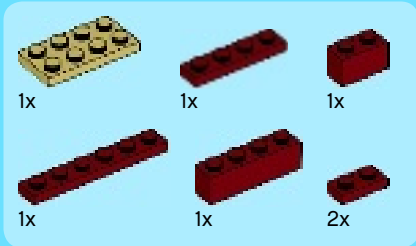

26

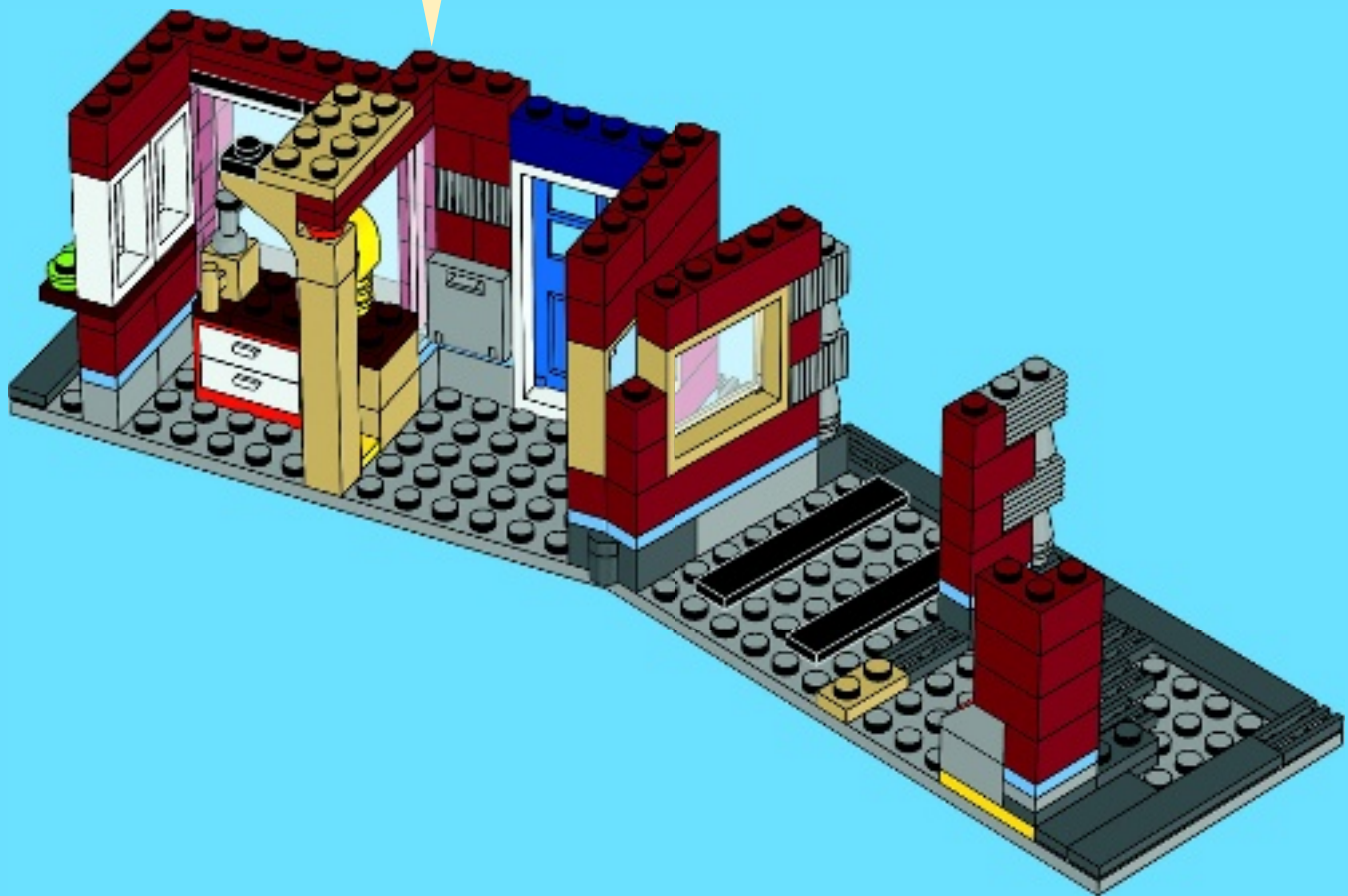
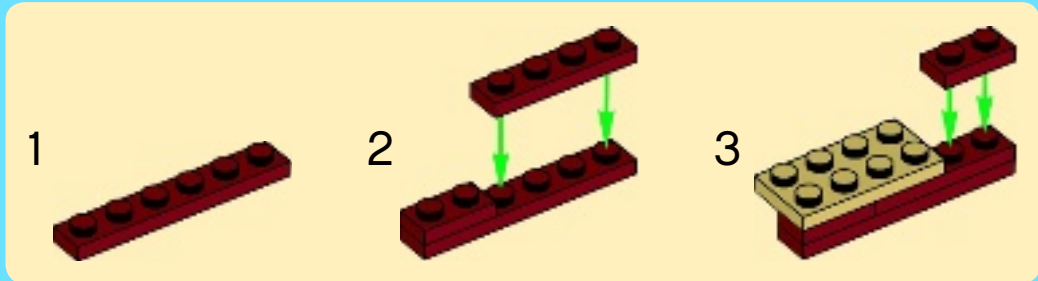

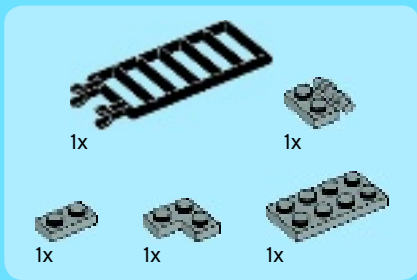

27

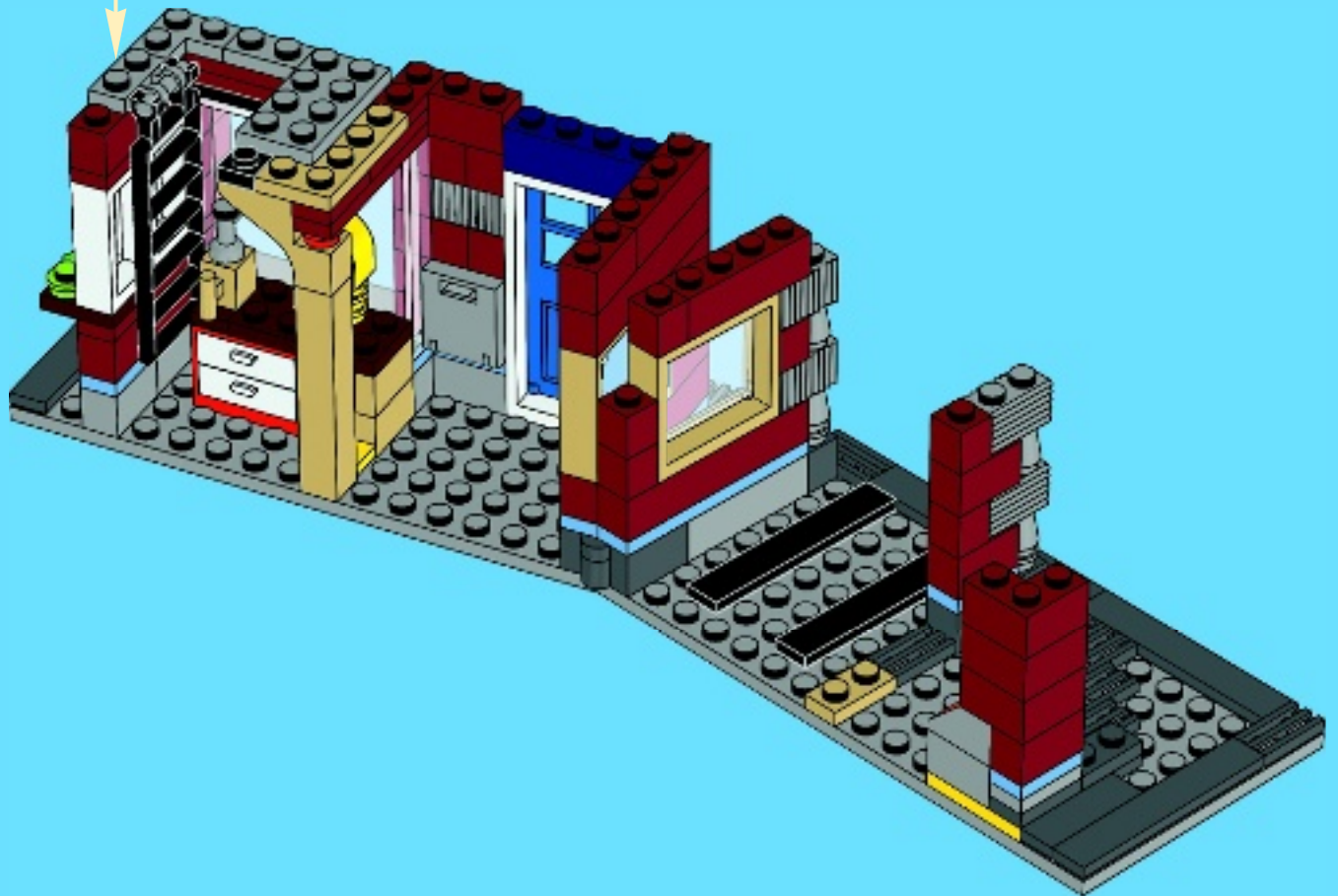
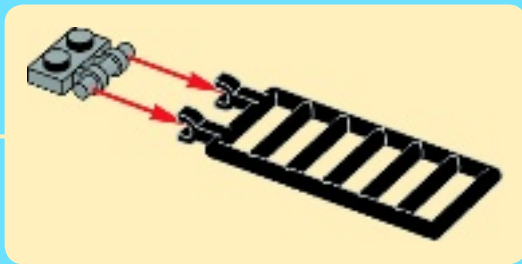

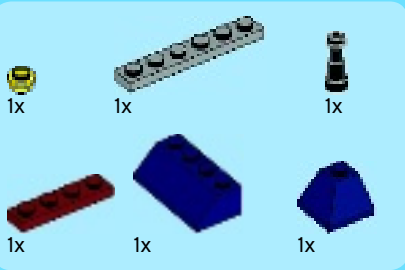

28

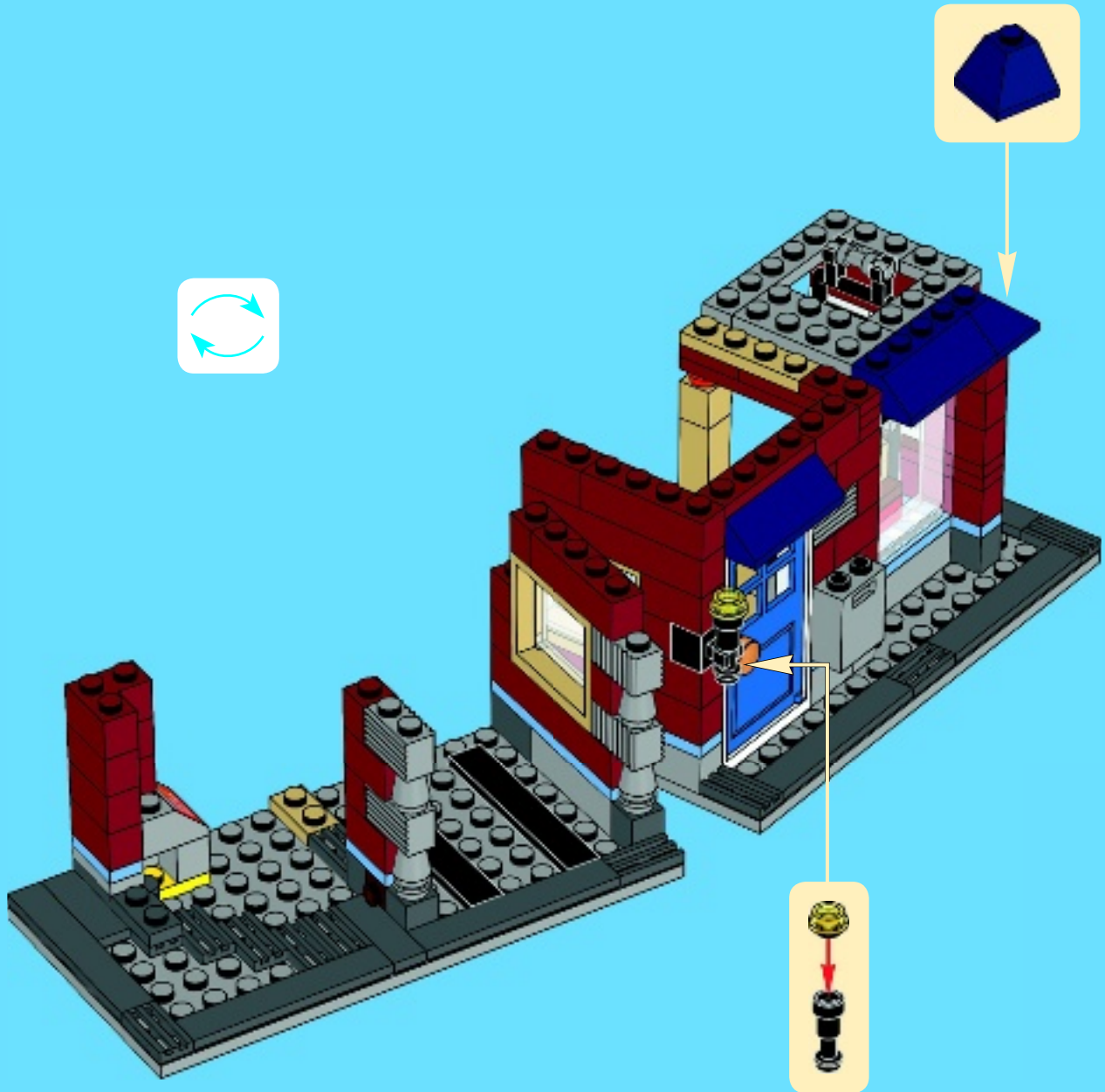



29

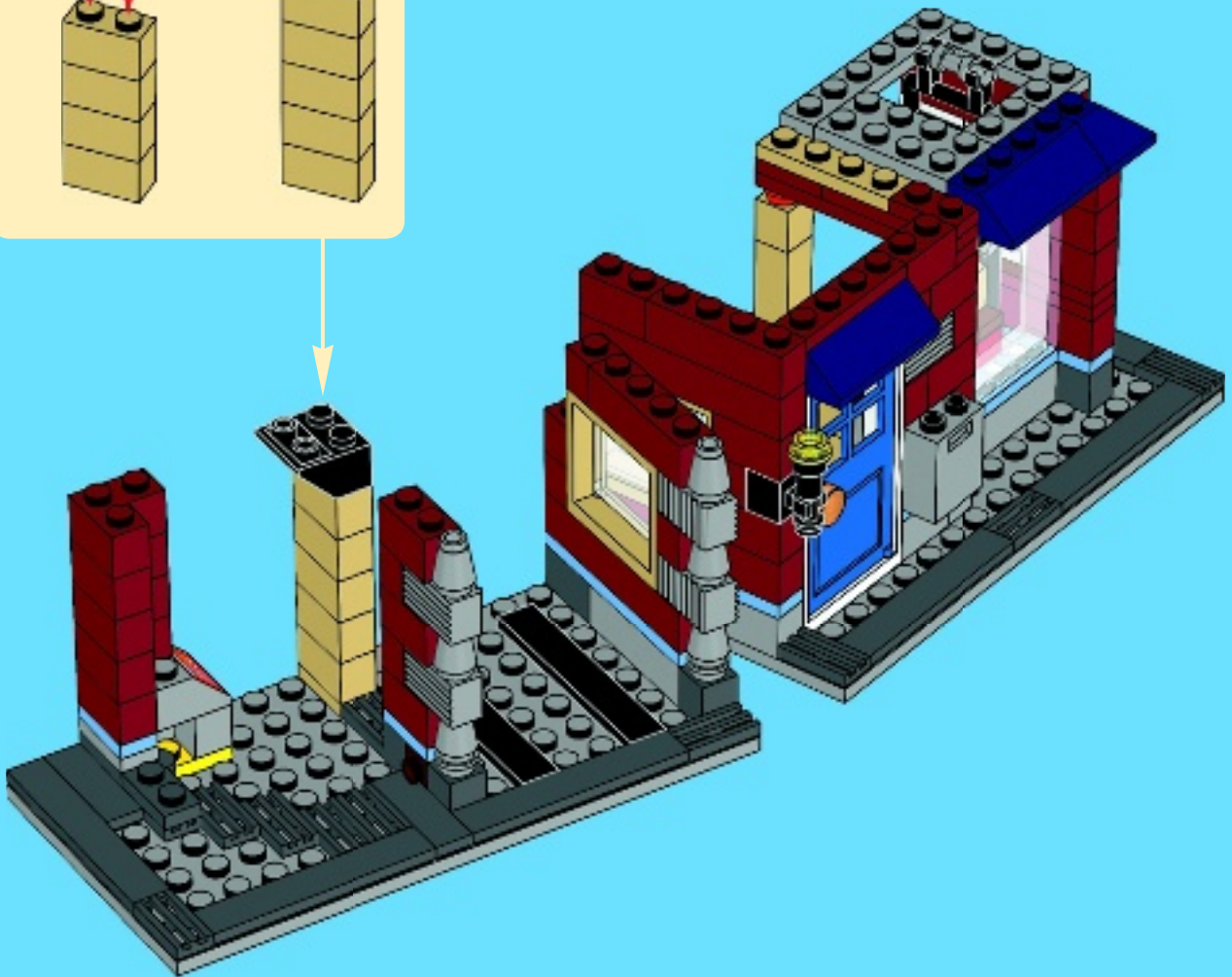
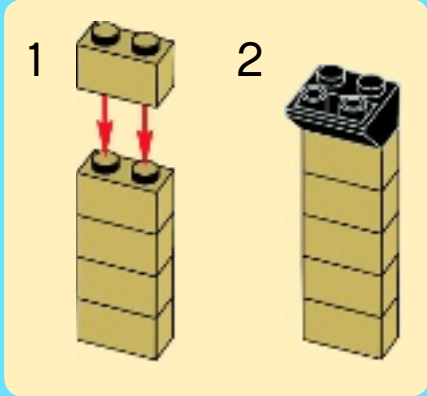

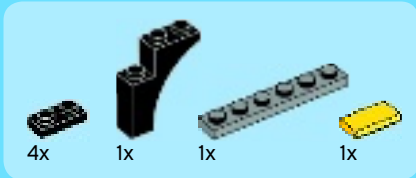

30

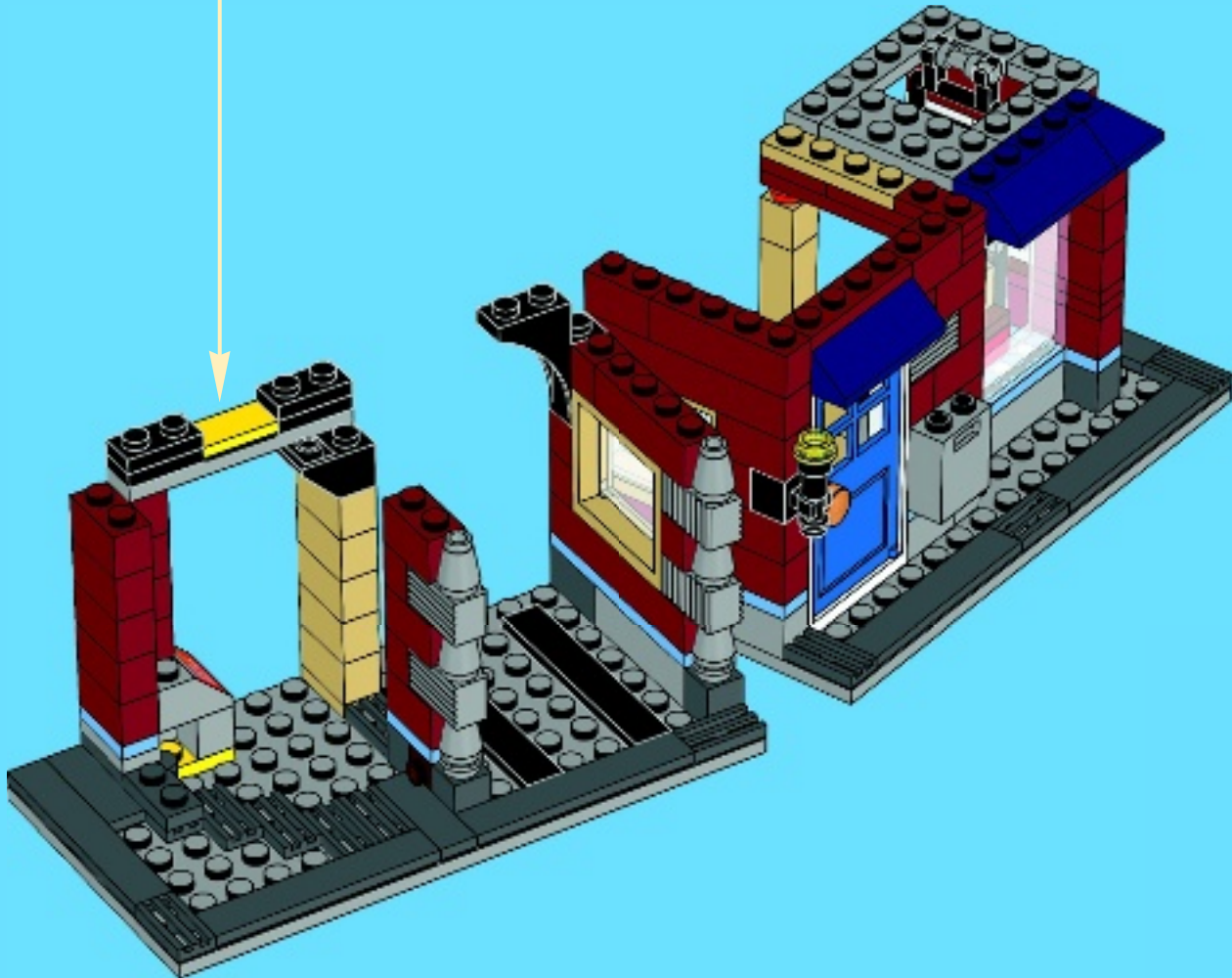
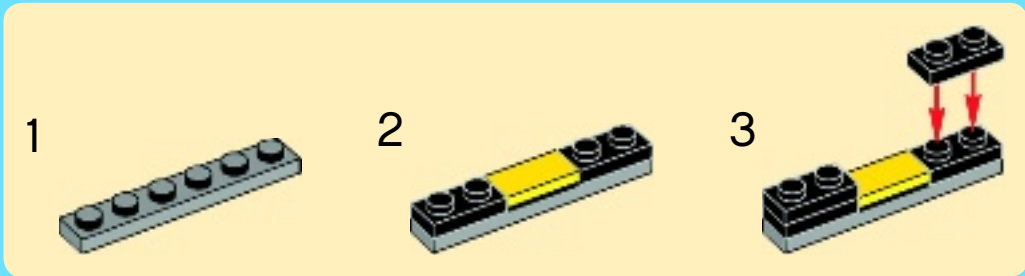

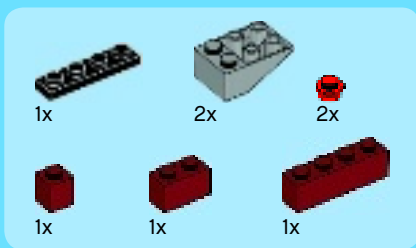

31

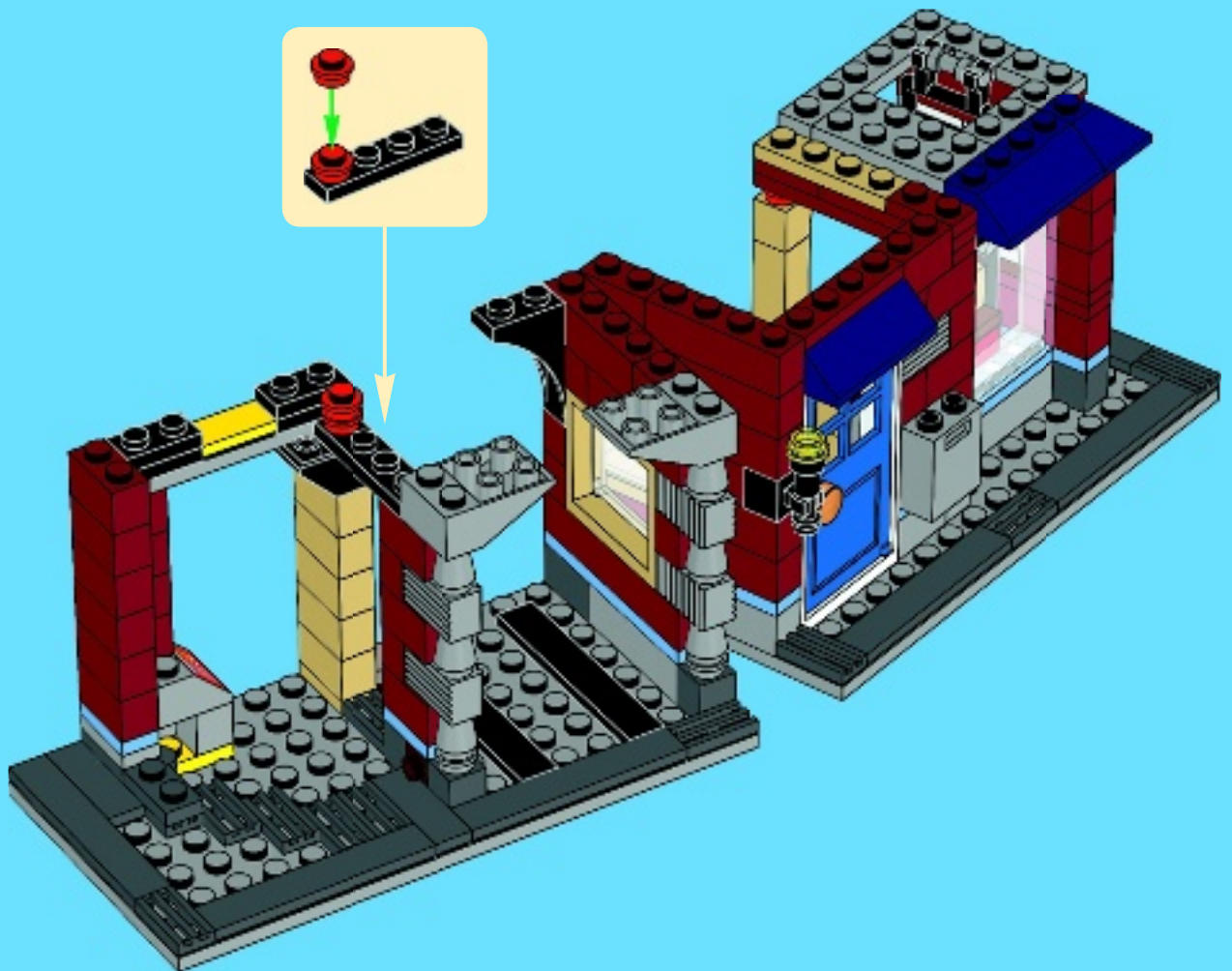

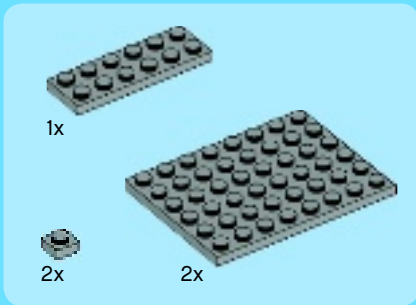

32

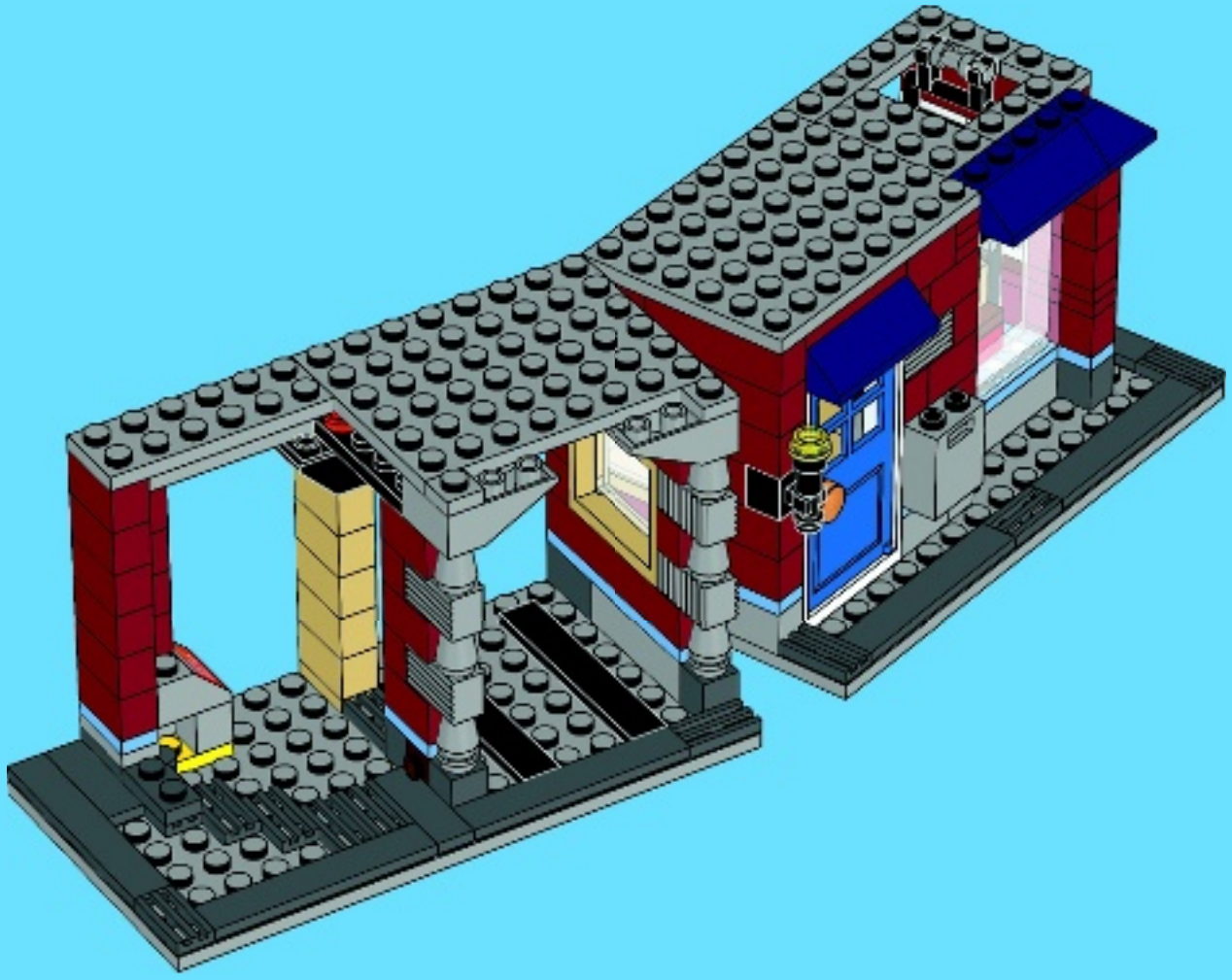

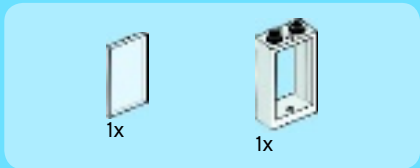
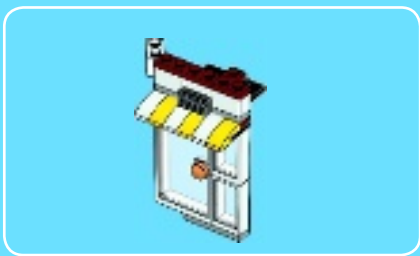

1

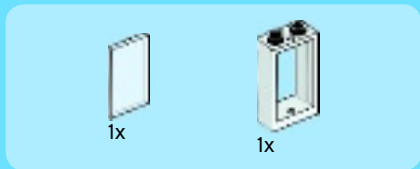
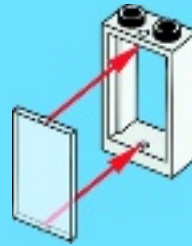

2

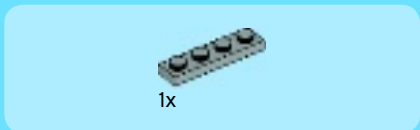
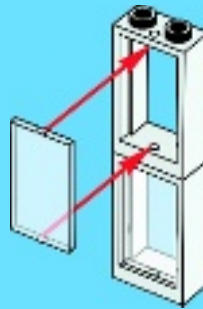

3

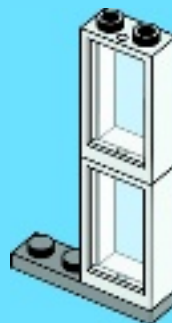

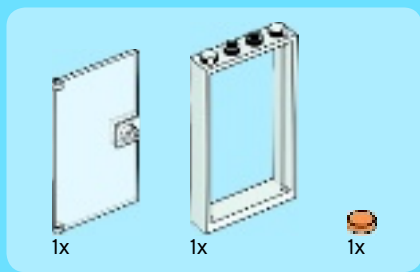

4

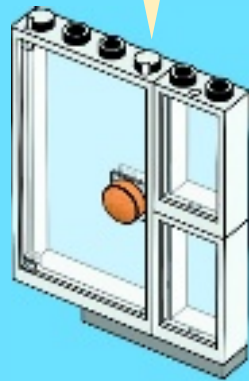
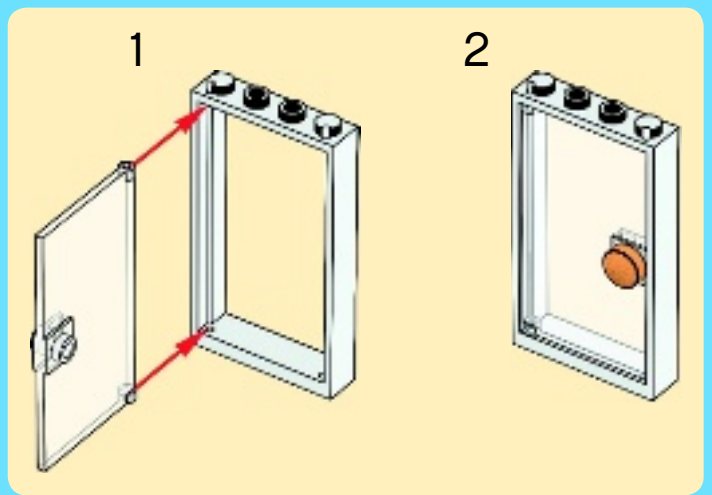

5

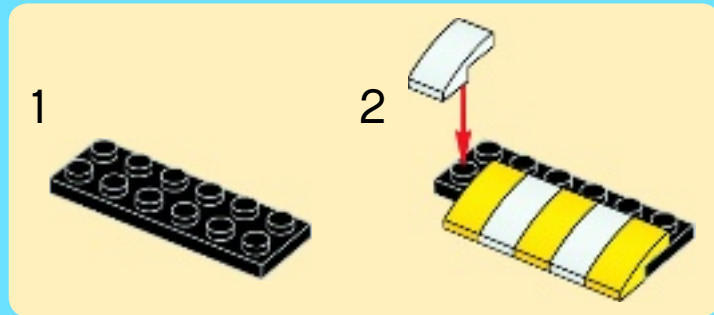



1x



2x

6

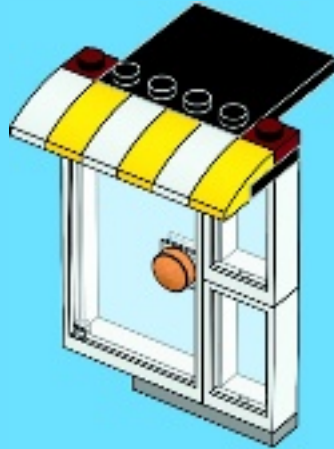

1x



1x



1x

7

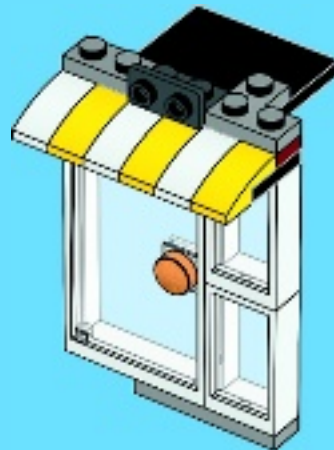



1x



1x



1x



1x

8

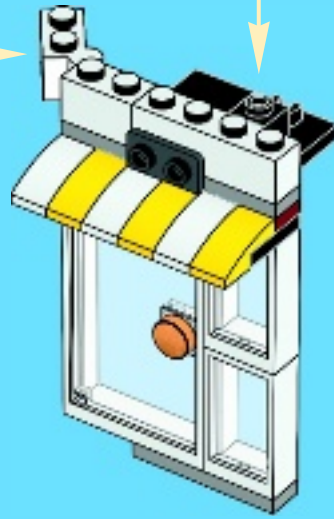
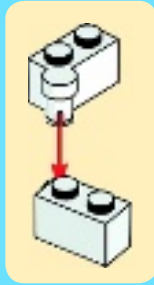

1x



1x



1x



1x

9

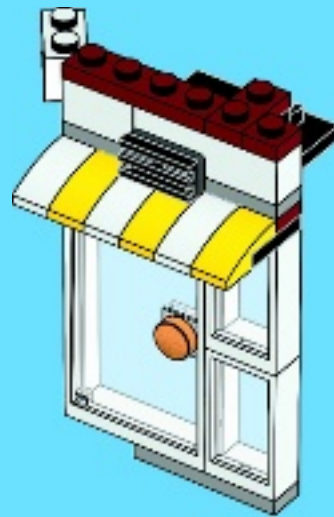

33

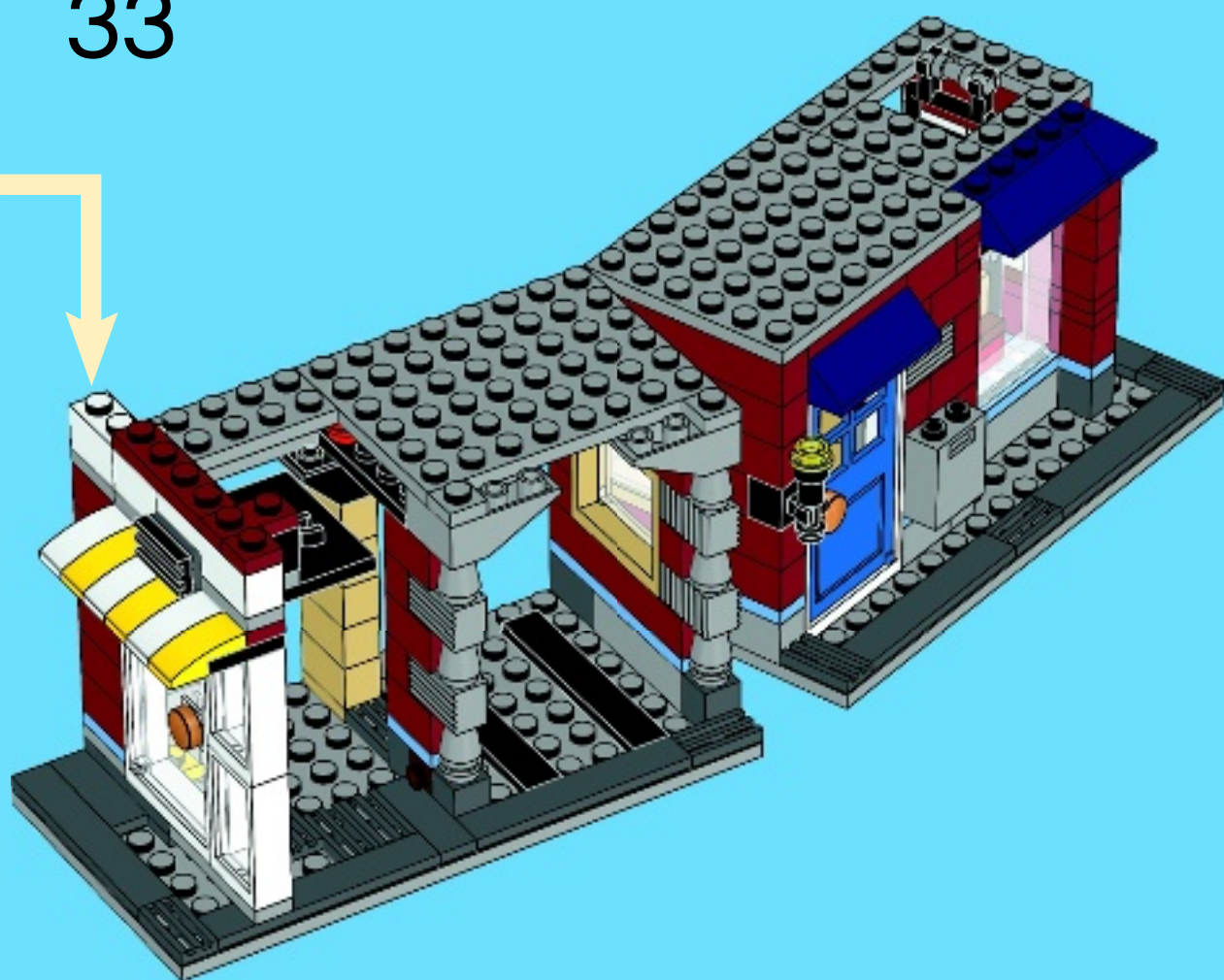

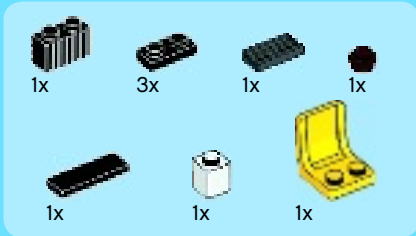

34

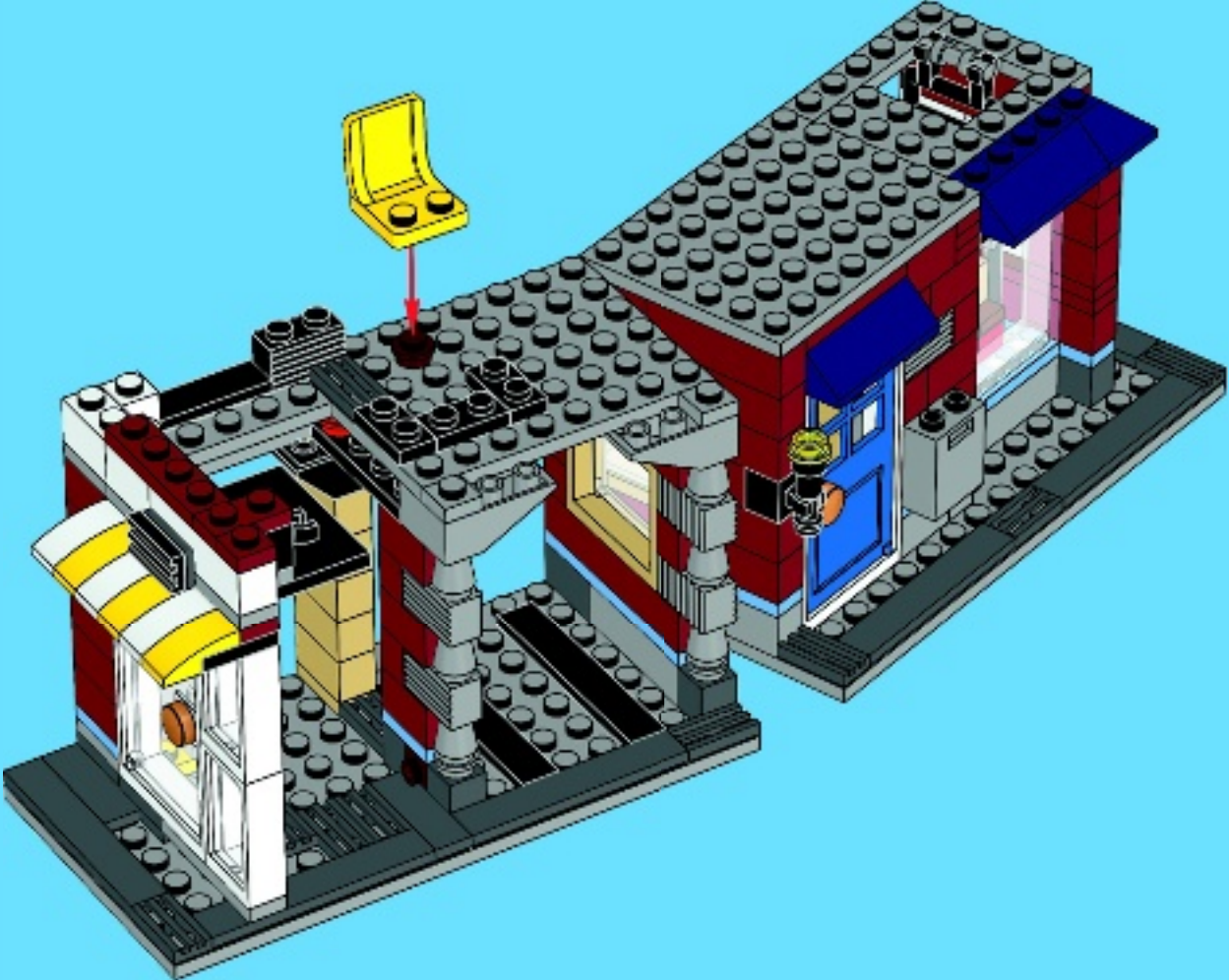



35

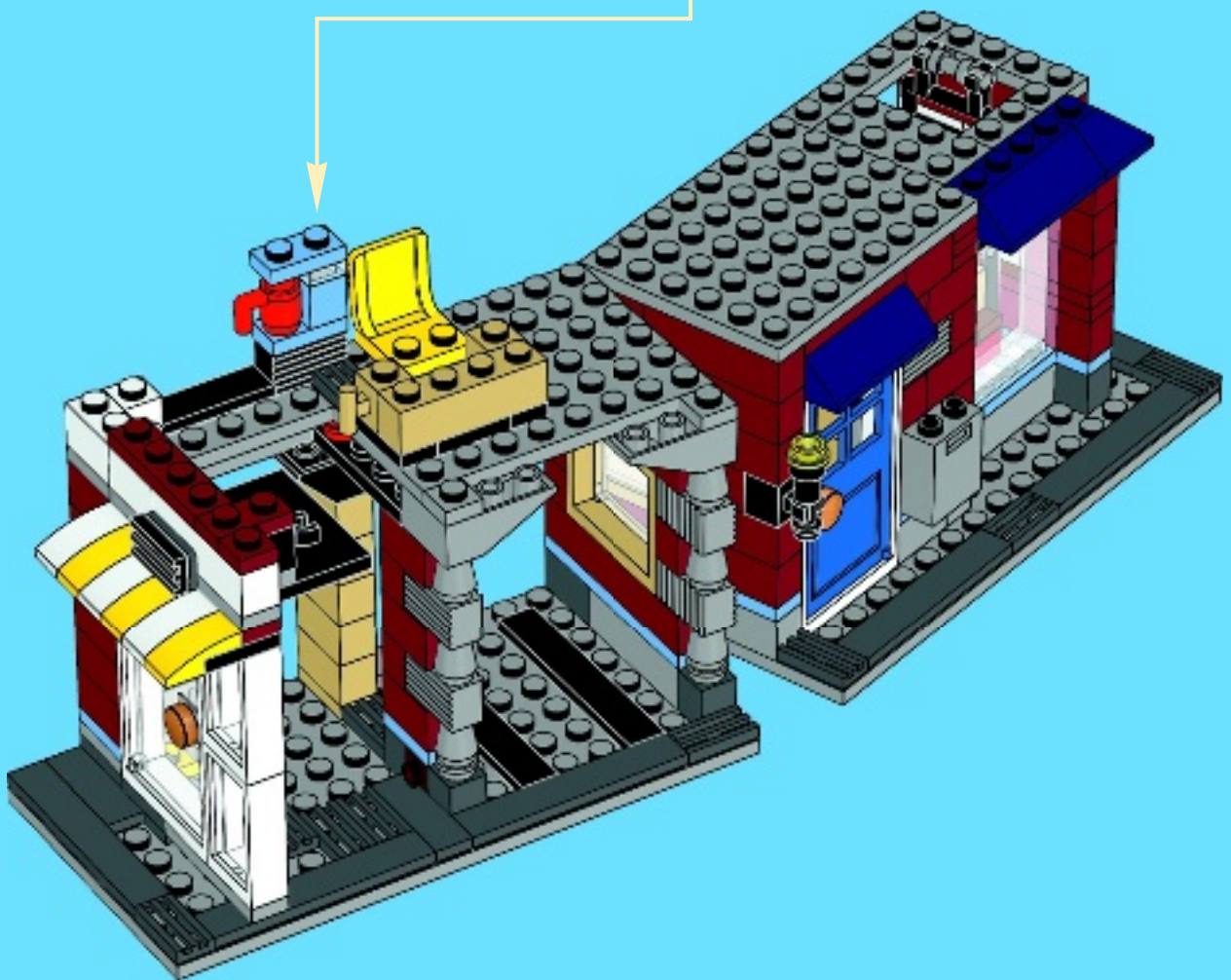



1x



1x



1x



1x



2x

36

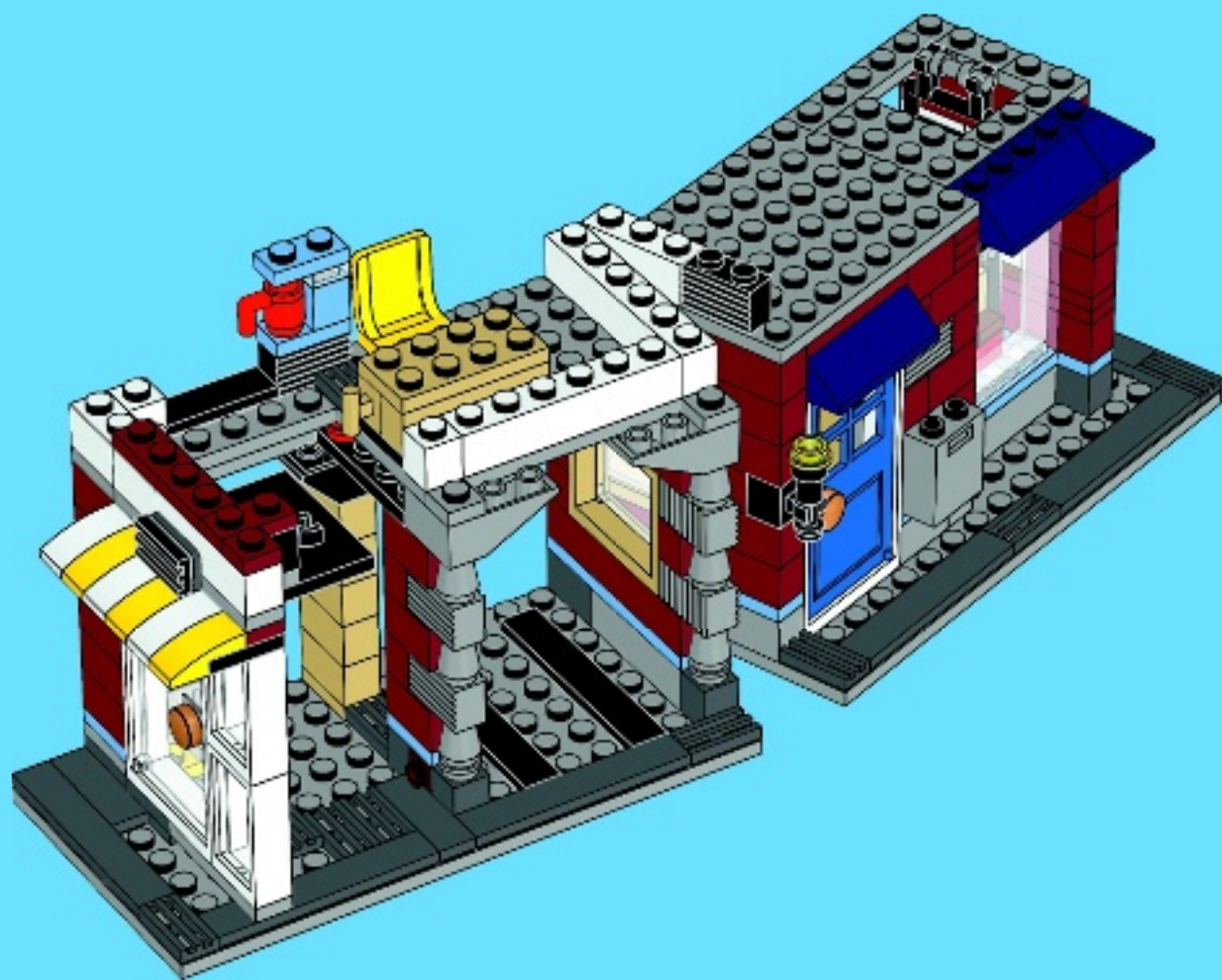

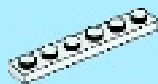

1



2

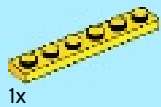
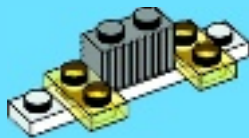

3



4

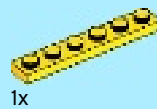

5

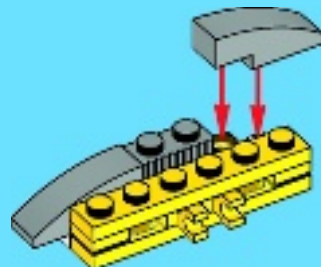



1x



2x

6

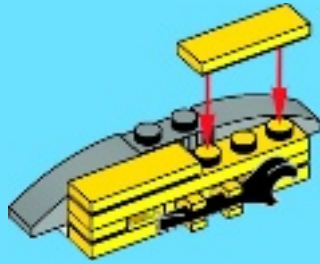

37

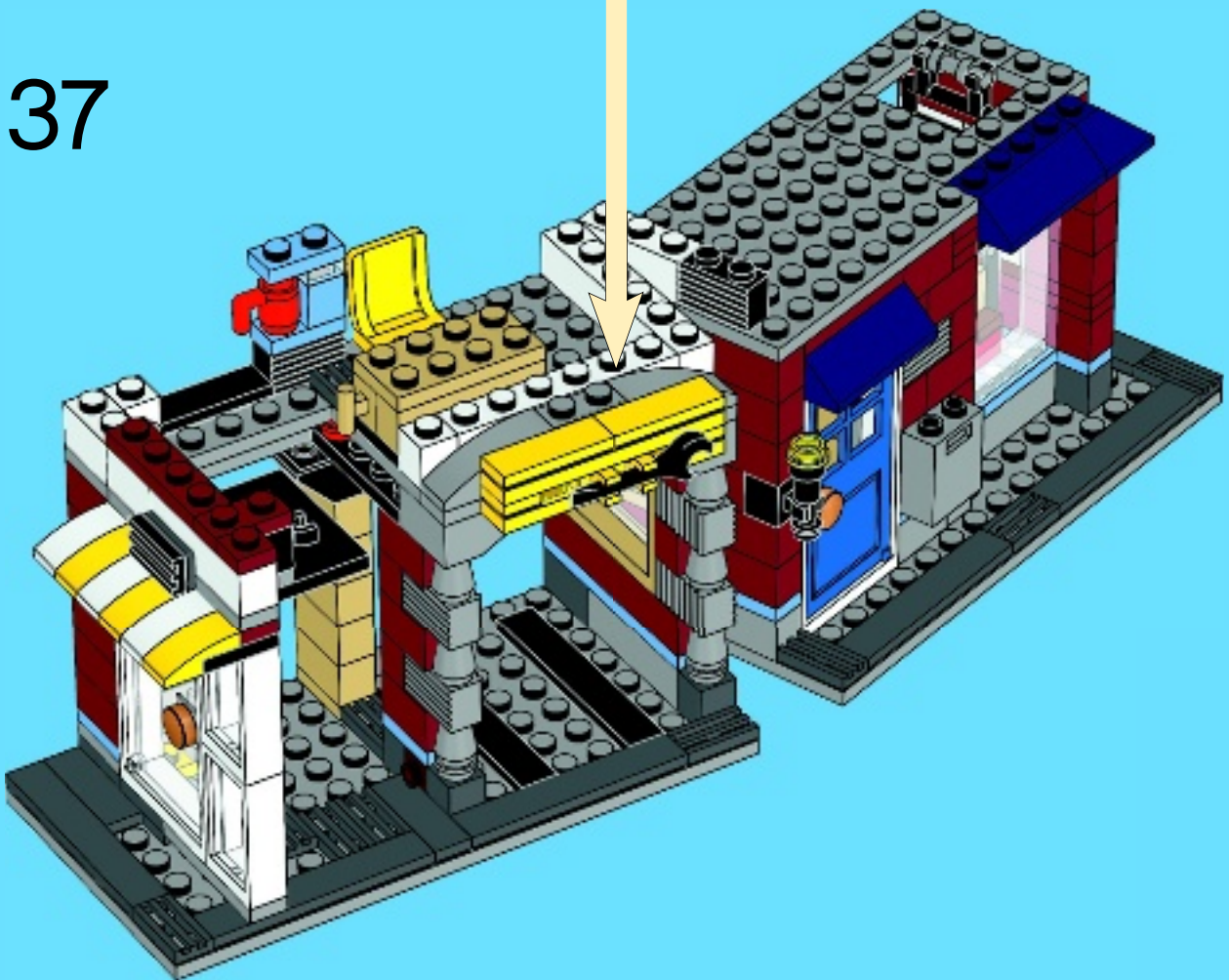



1x



1x



1x



1x



1x



1x

38

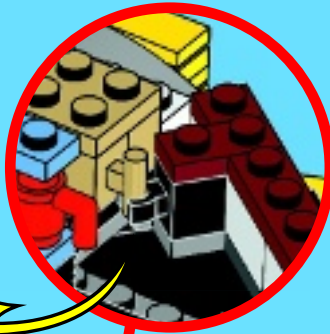

CLICK

CLIC

单击

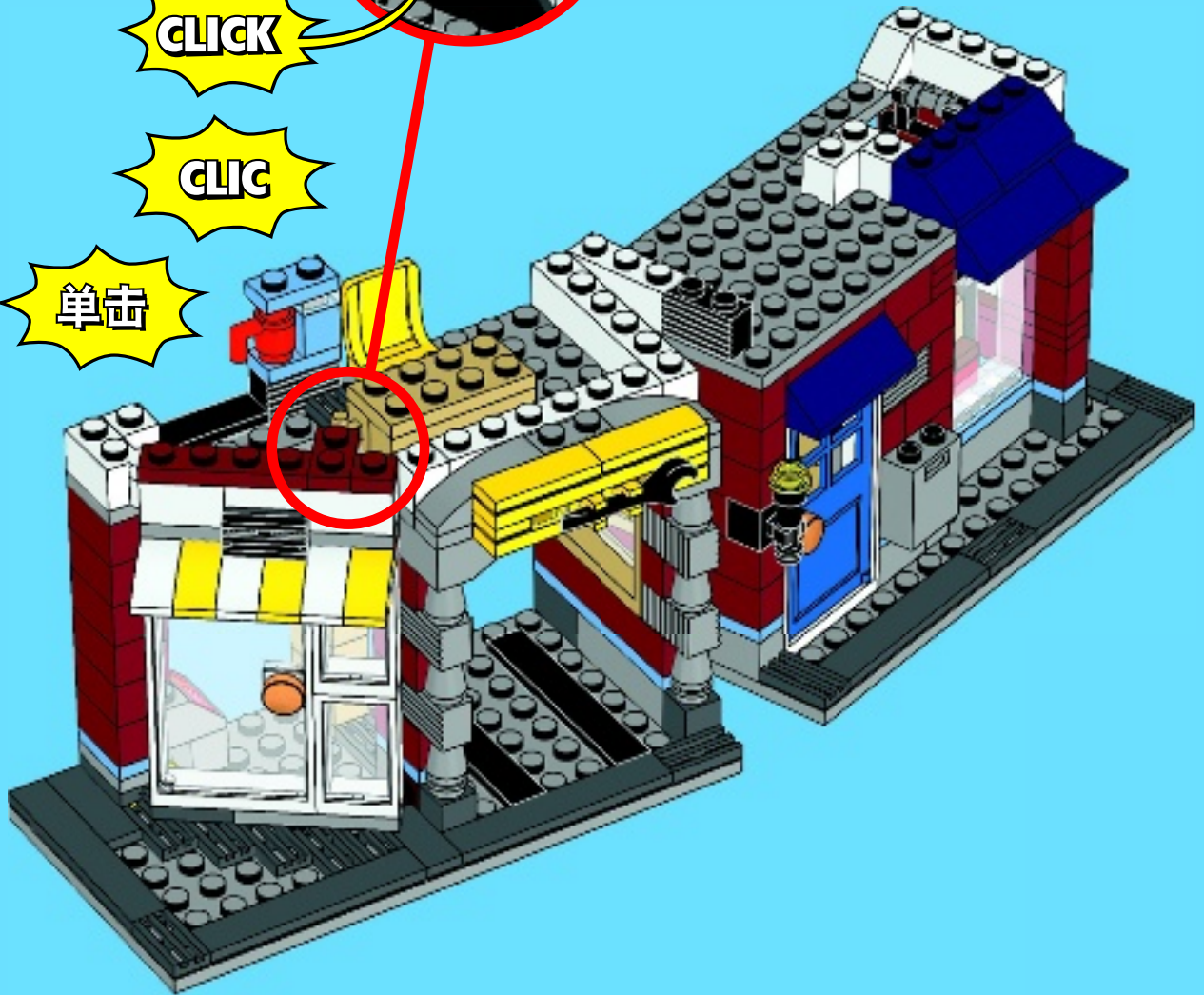

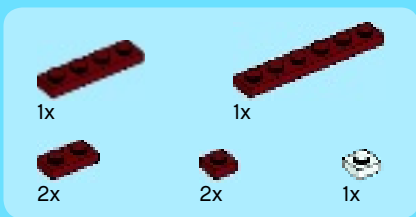

39

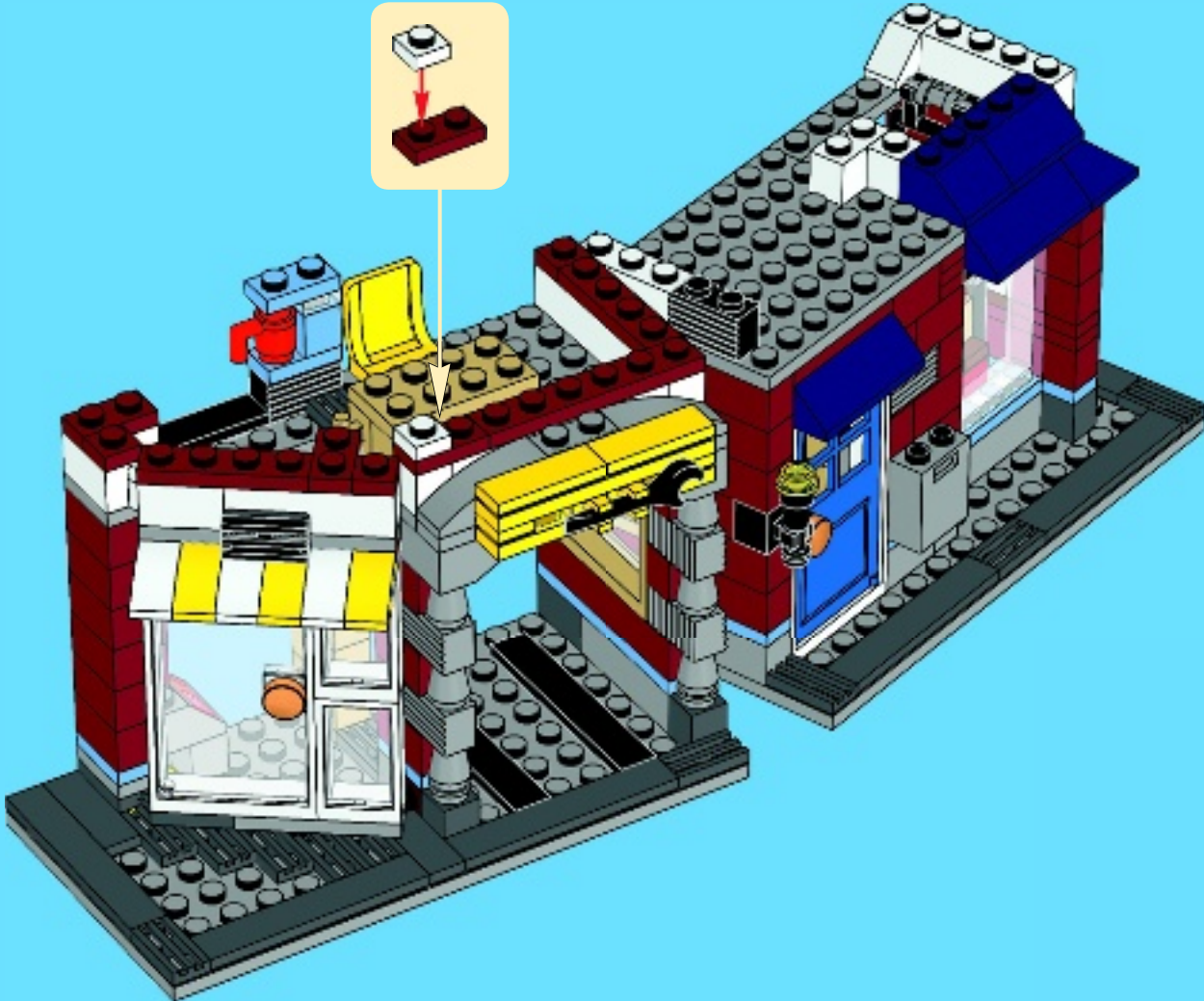

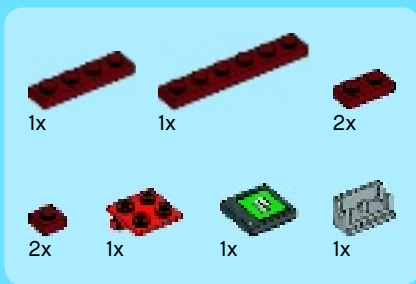

40

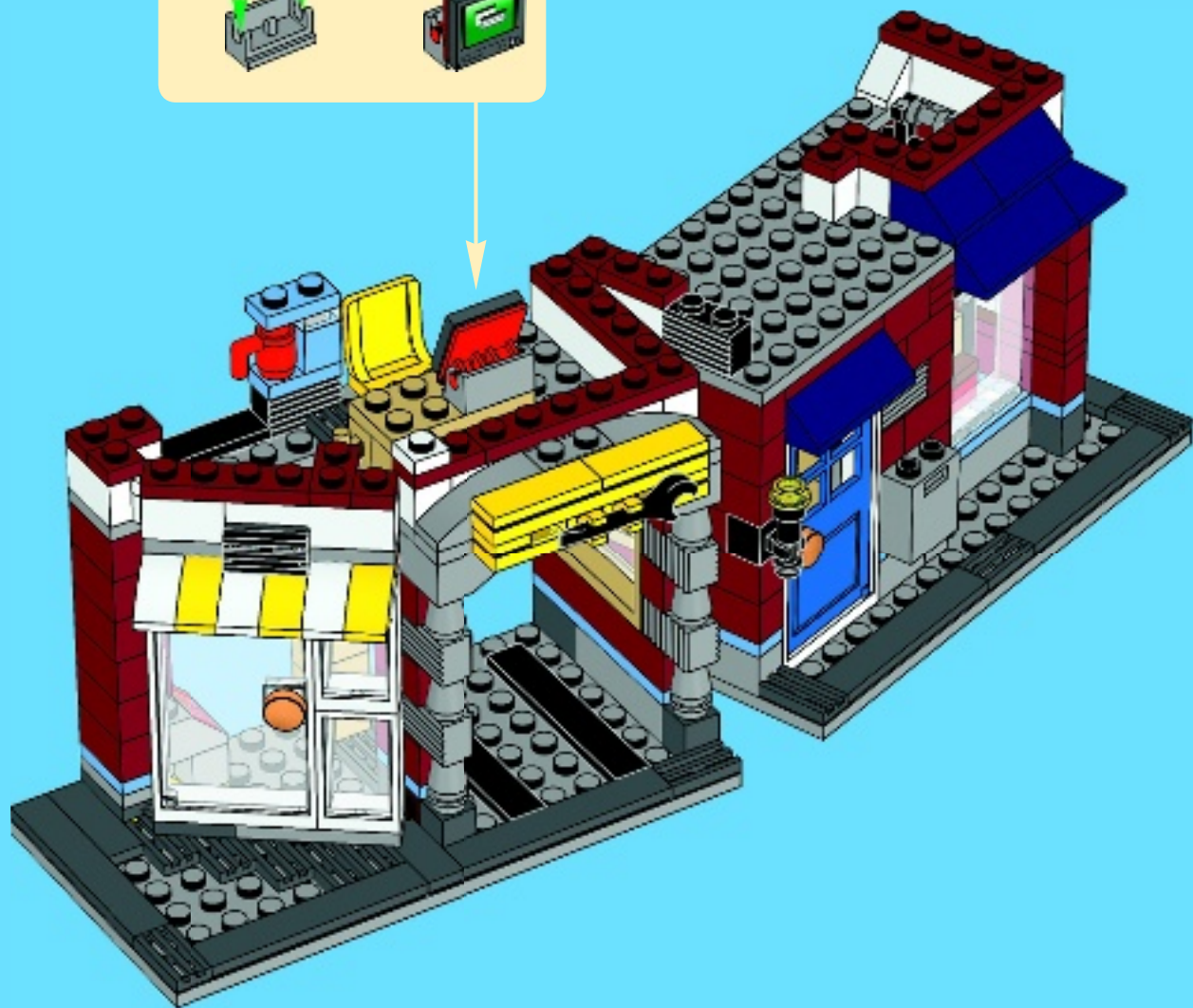
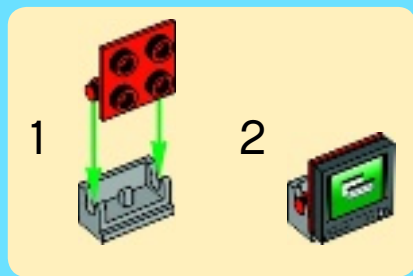



1x



1x



6x



1x



1x

41



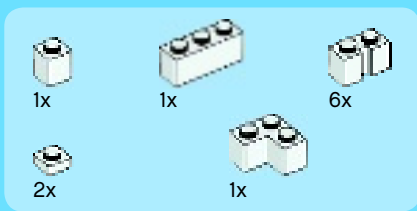

42

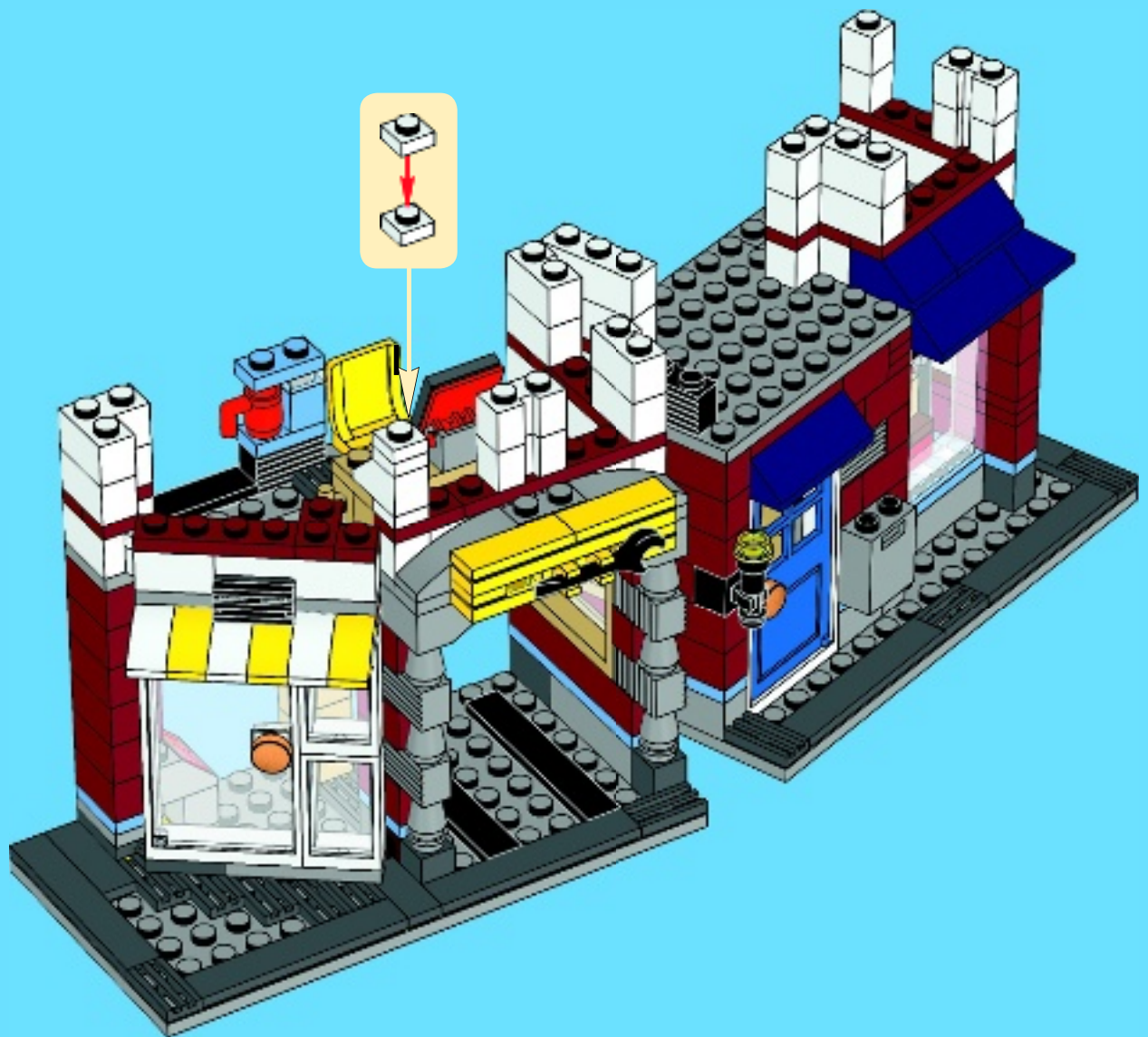



2x



1x



3x



2x

43

1



2

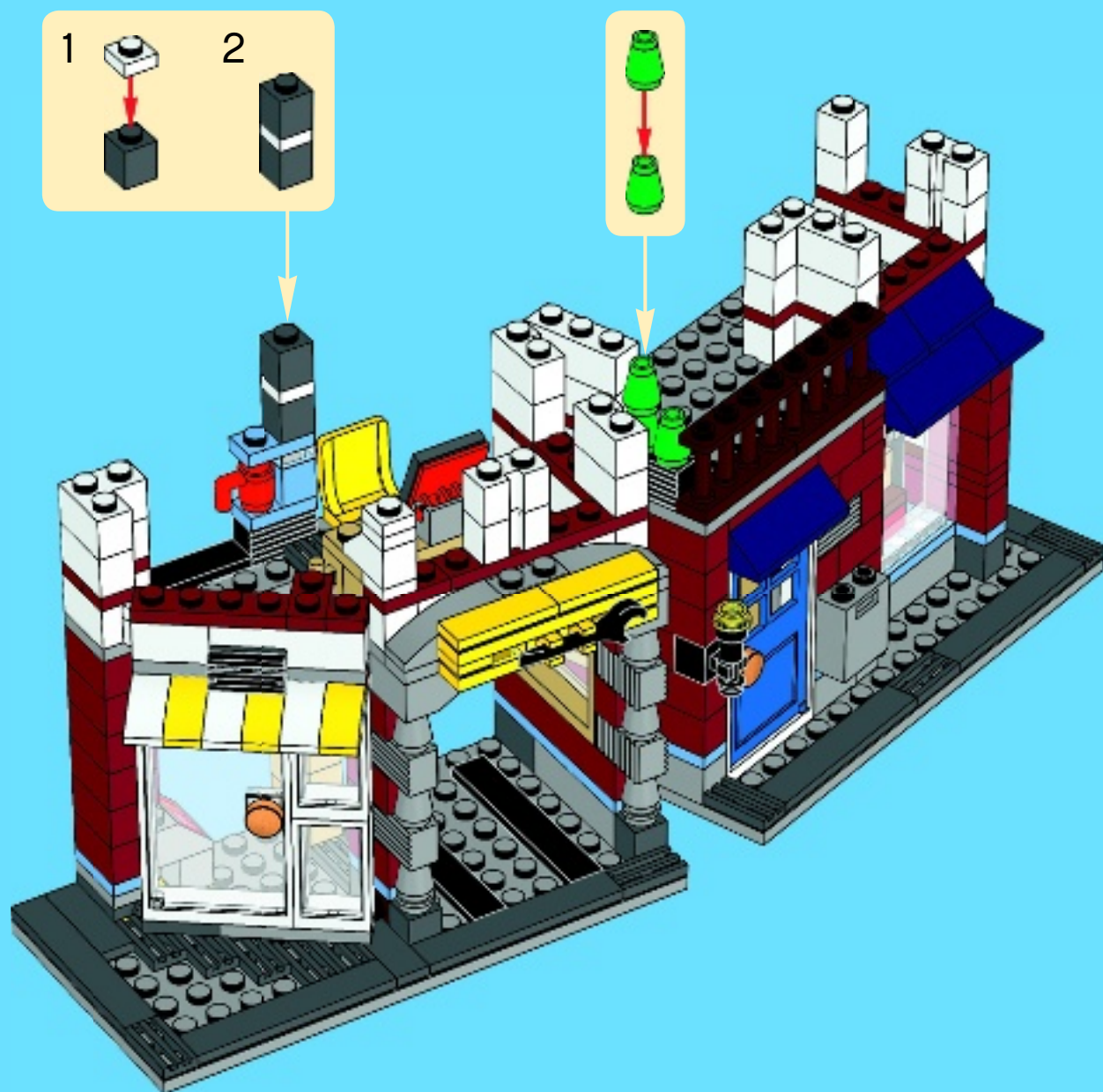
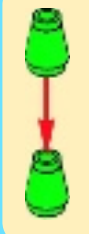

- | | | | |
|----|----|----|----|
| | | | |
| 1x | 4x | 3x | 2x |
| | | | |
| 1x | 1x | 1x | 1x |

44

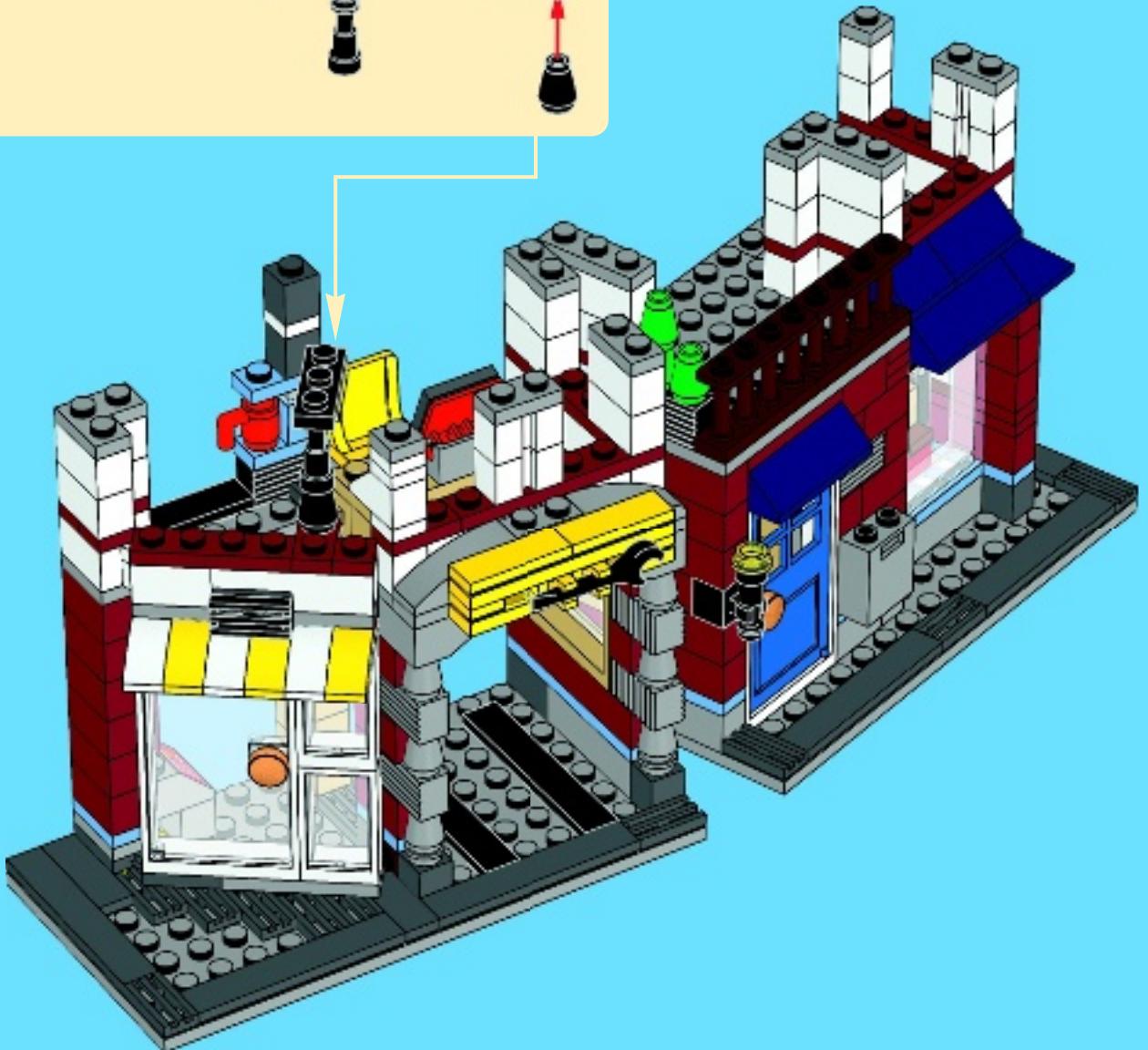
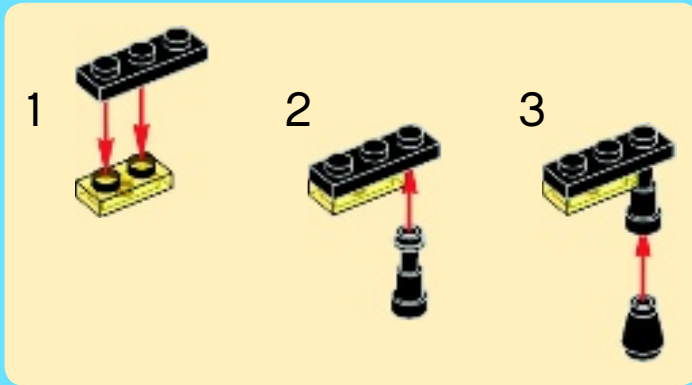



2x



1x



6x



1x

45

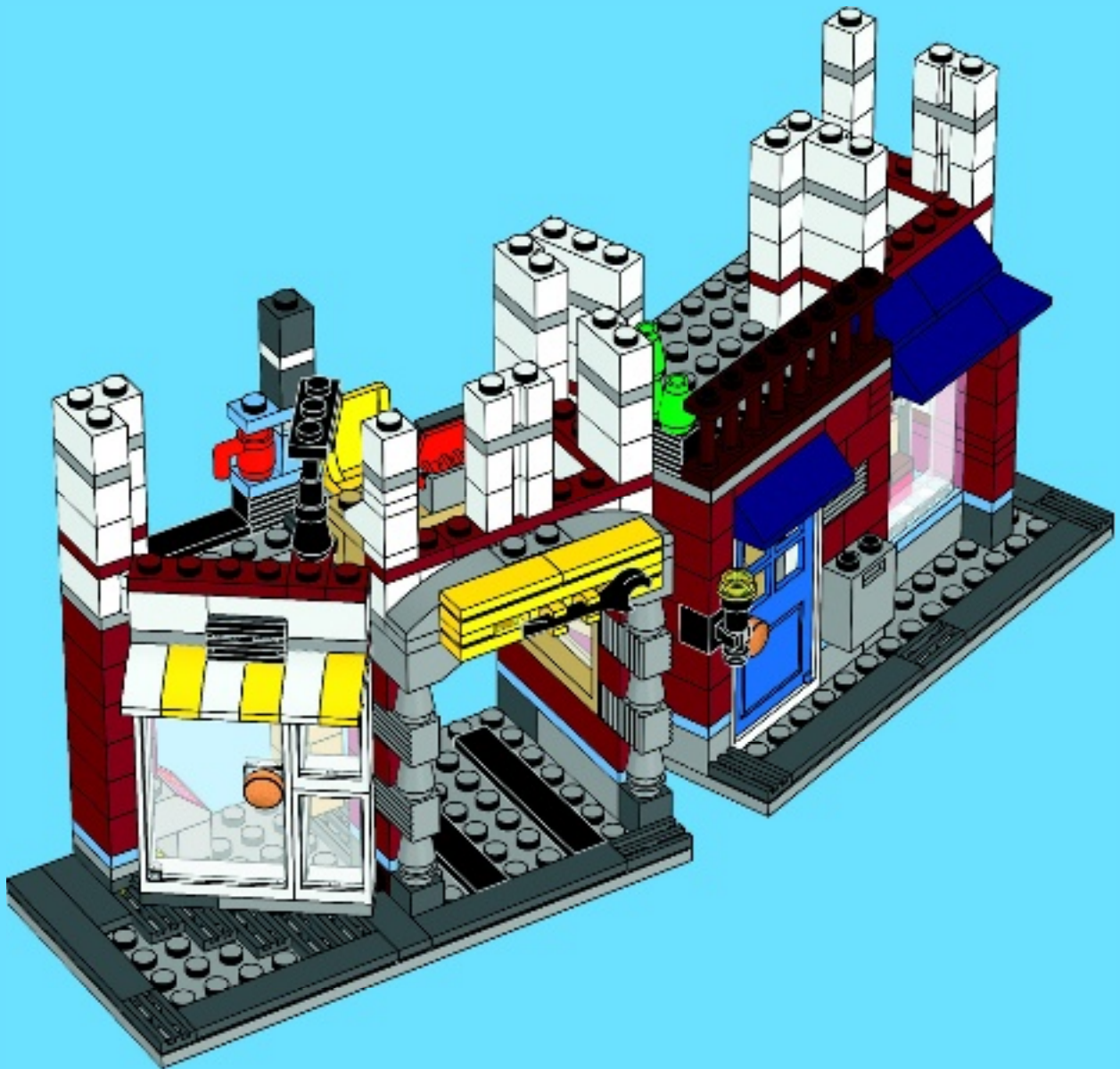



12x



12x

46

1

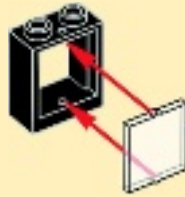

2

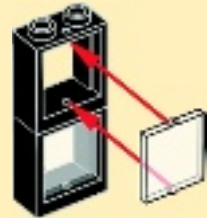

6x





2x



1x



5x



1x



1x

47

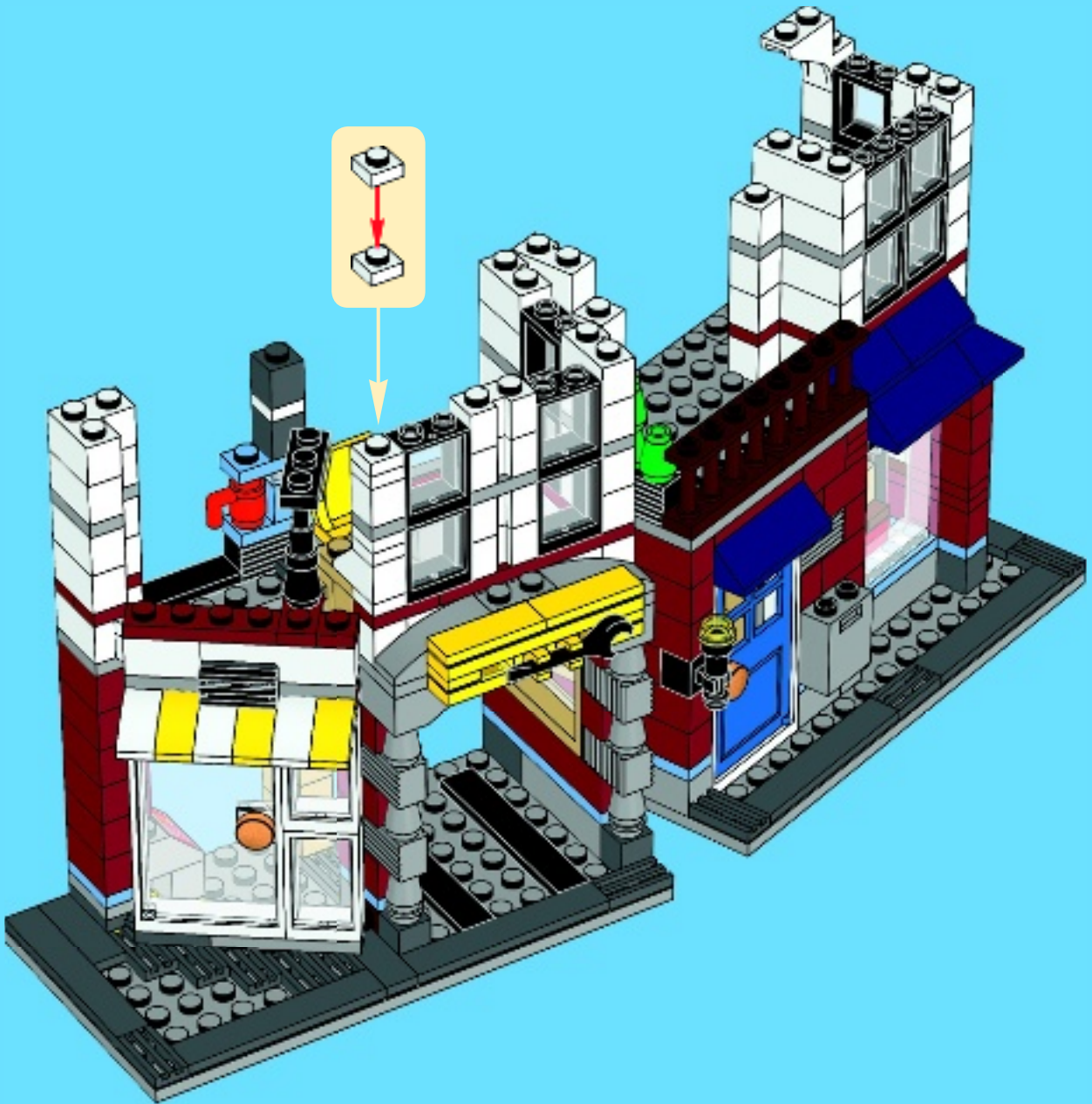
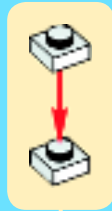

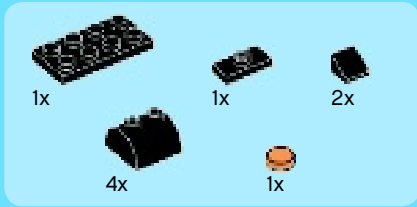

48

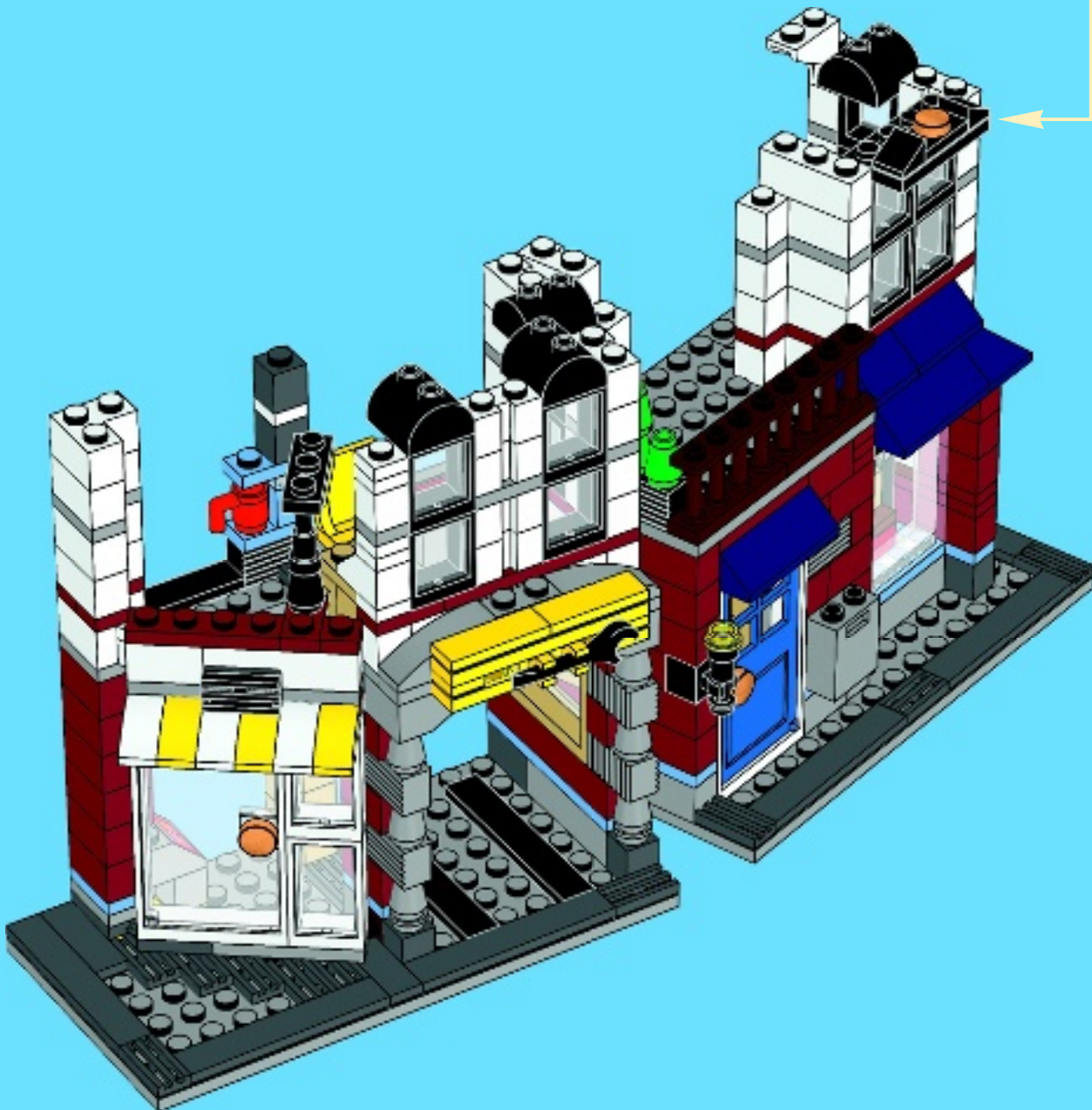
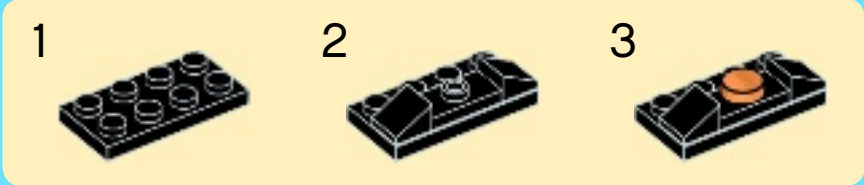



2x



1x



1x



2x

49

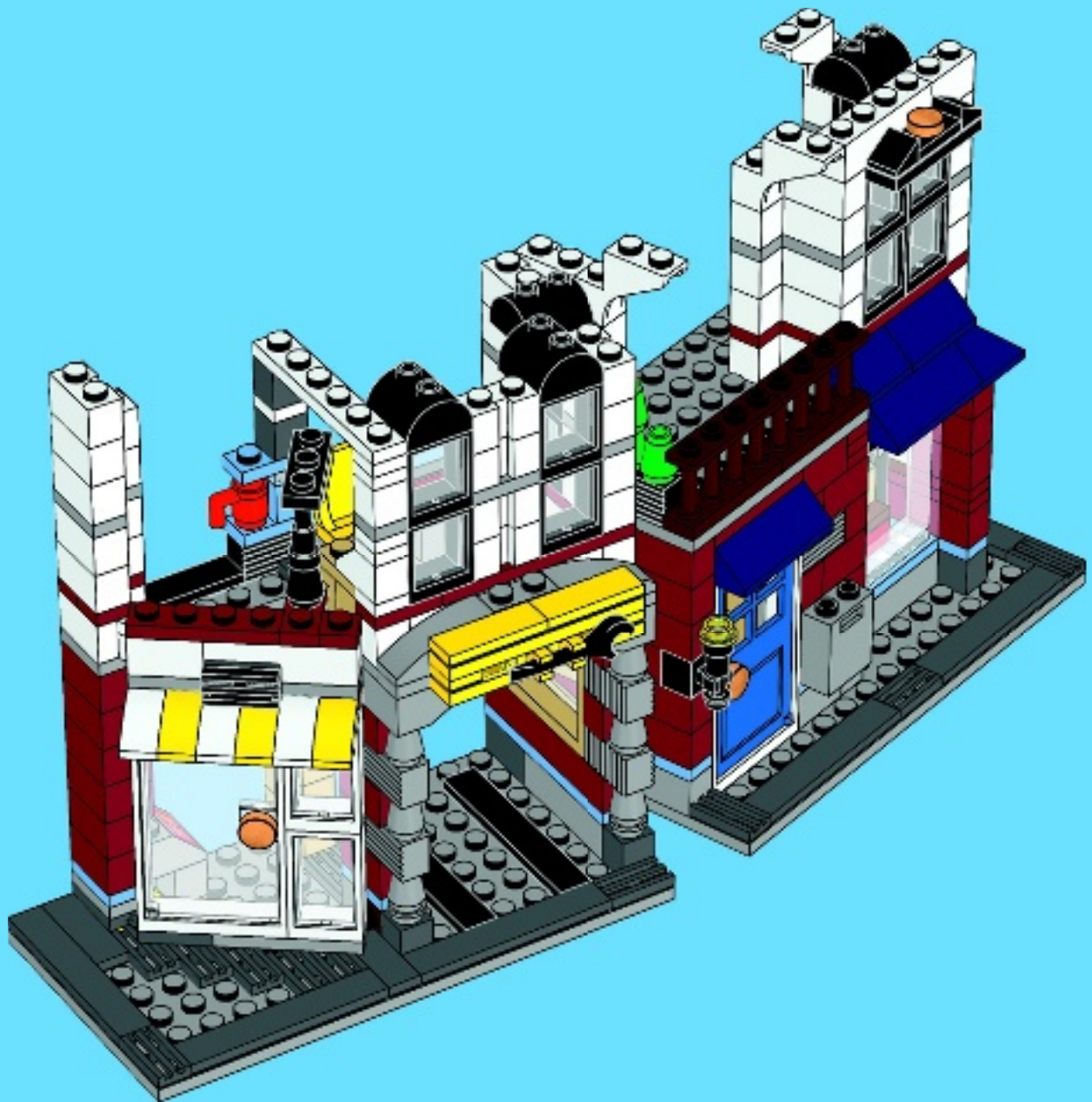



1x

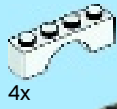

4x



1x



2x



2x

1

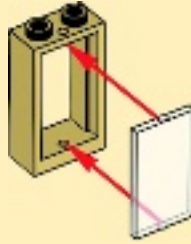

2

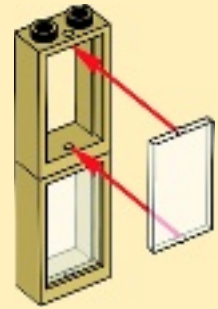

50

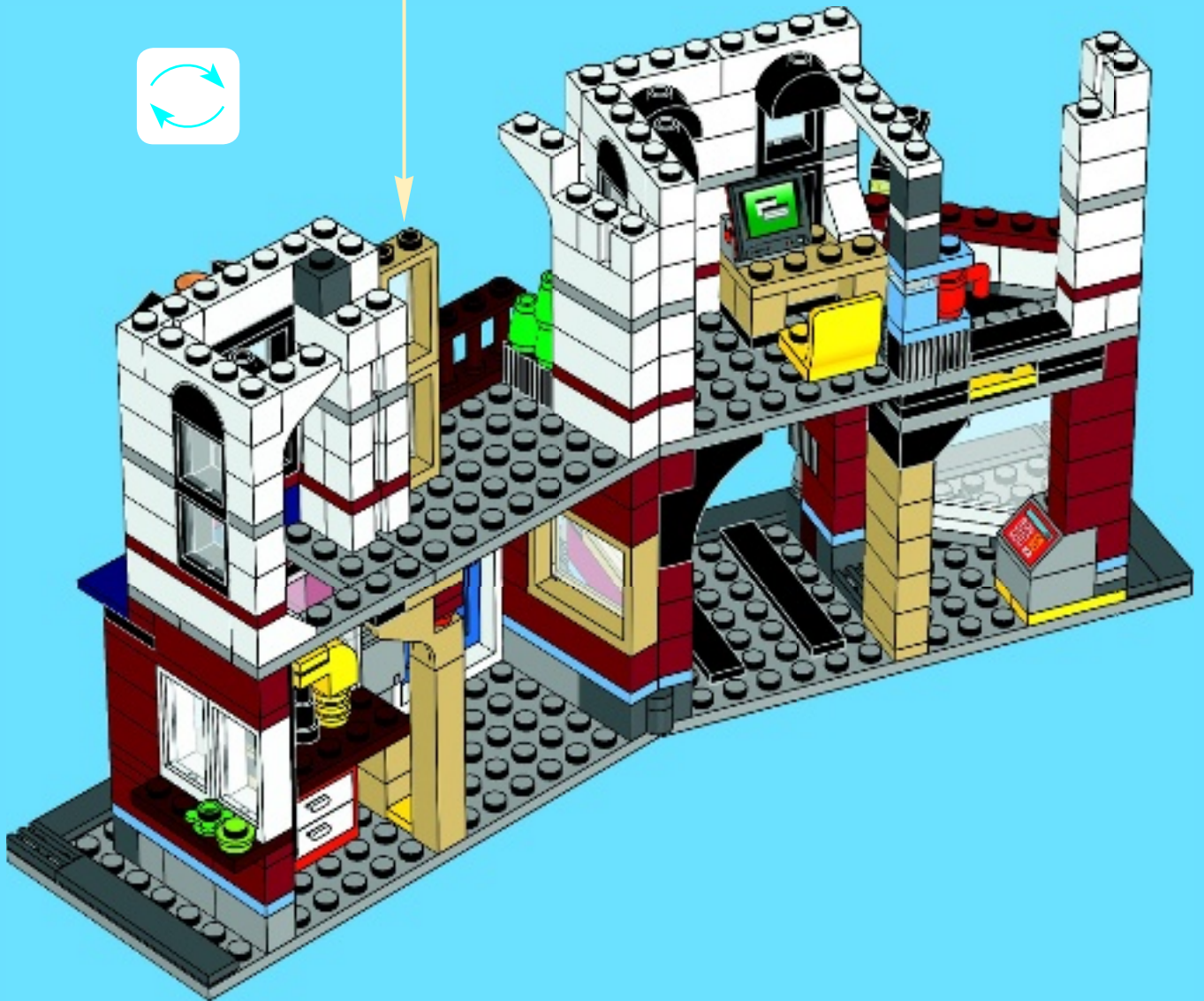

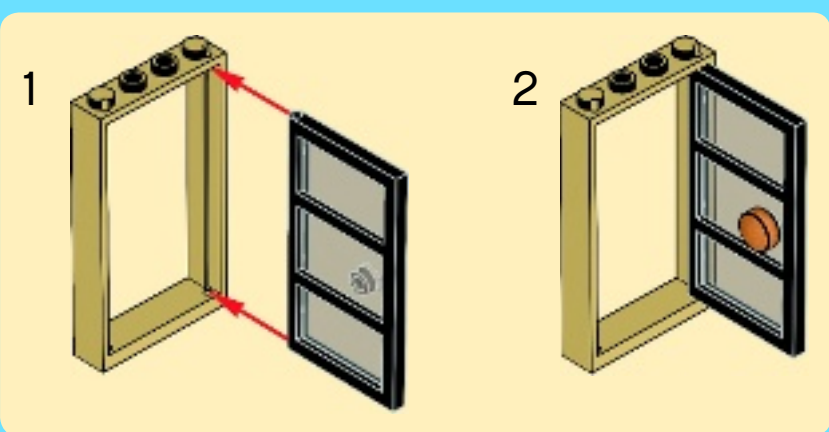
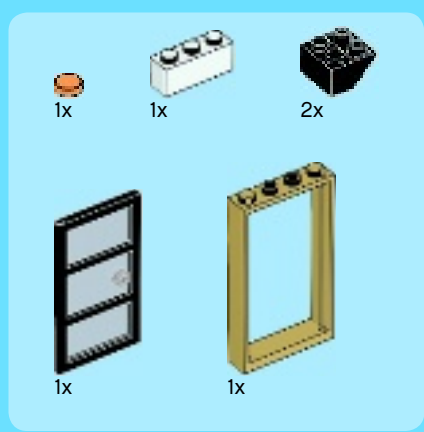

51

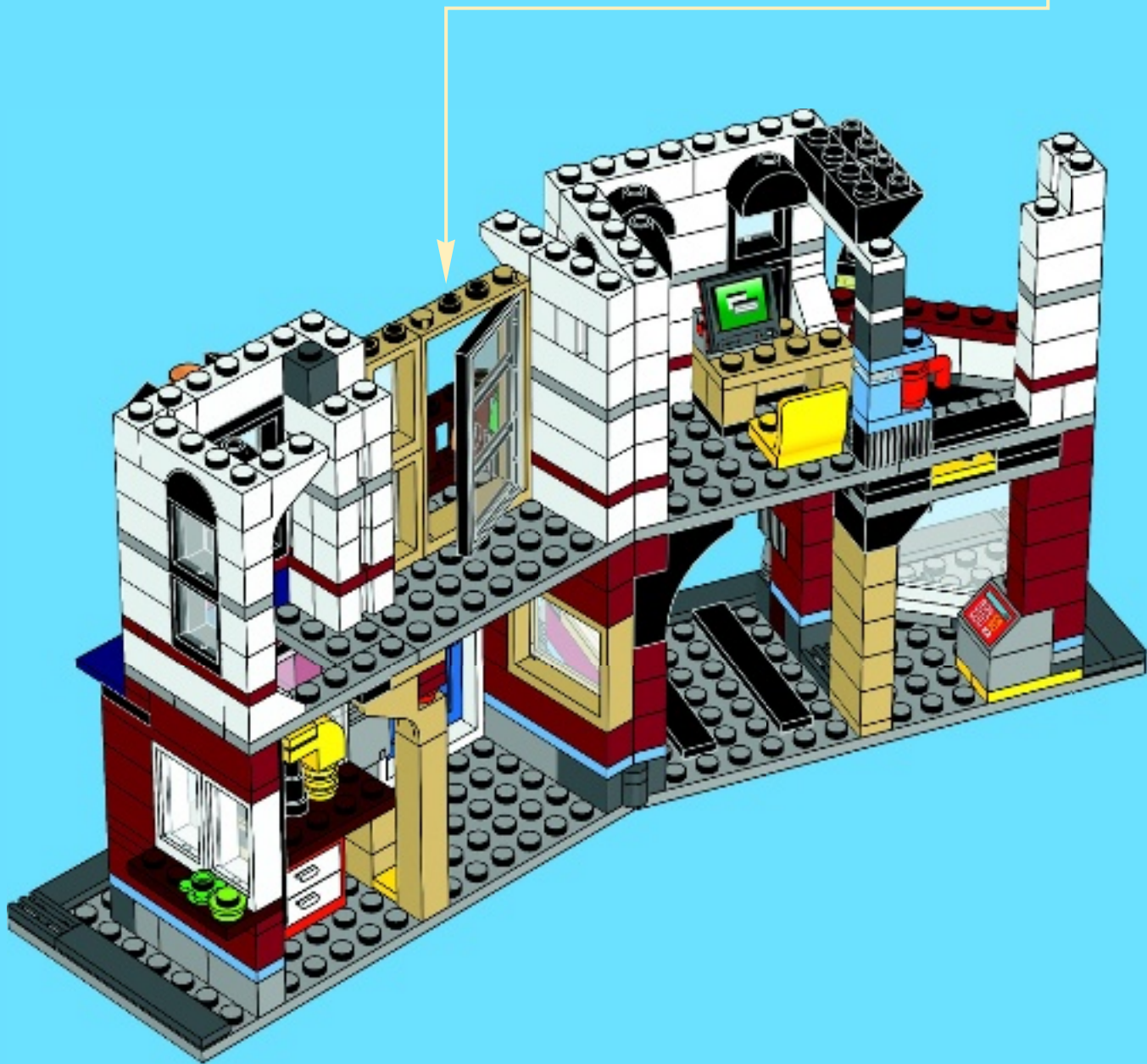



2x



2x



1x



1x

52

1

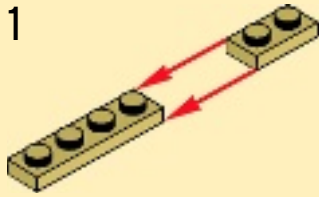

2

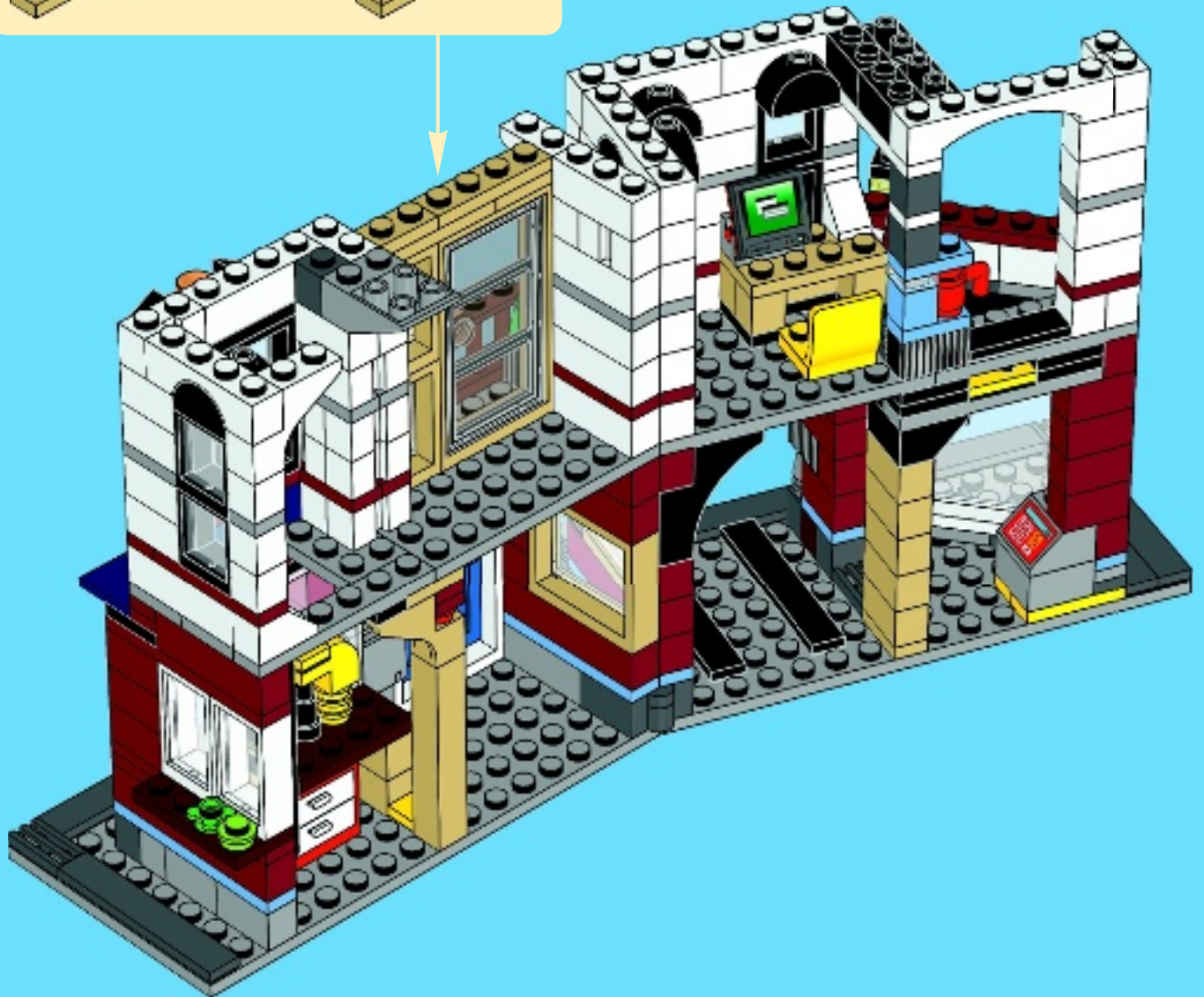
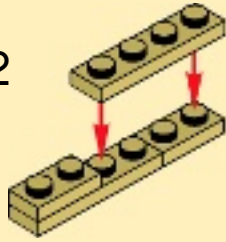

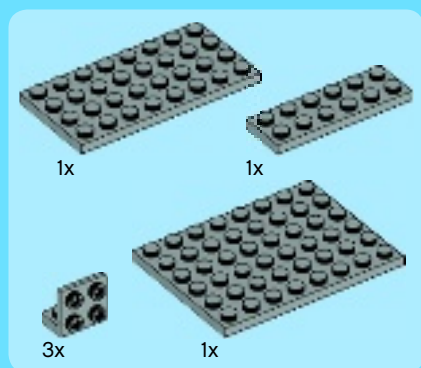

53

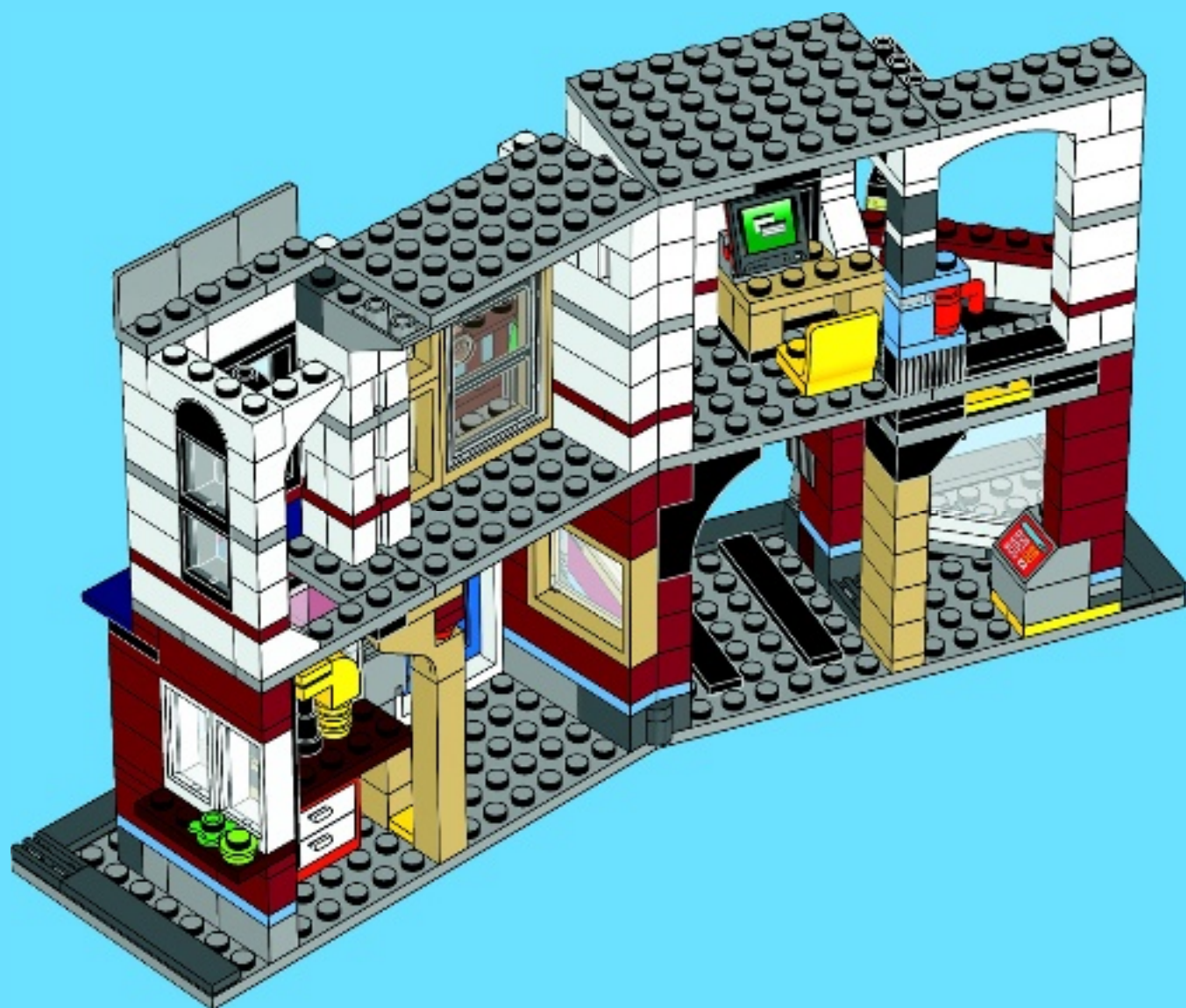

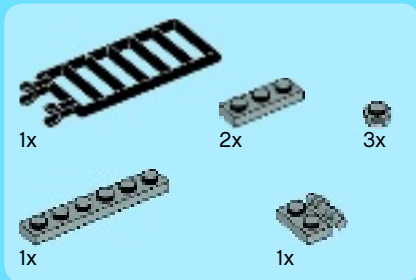

54

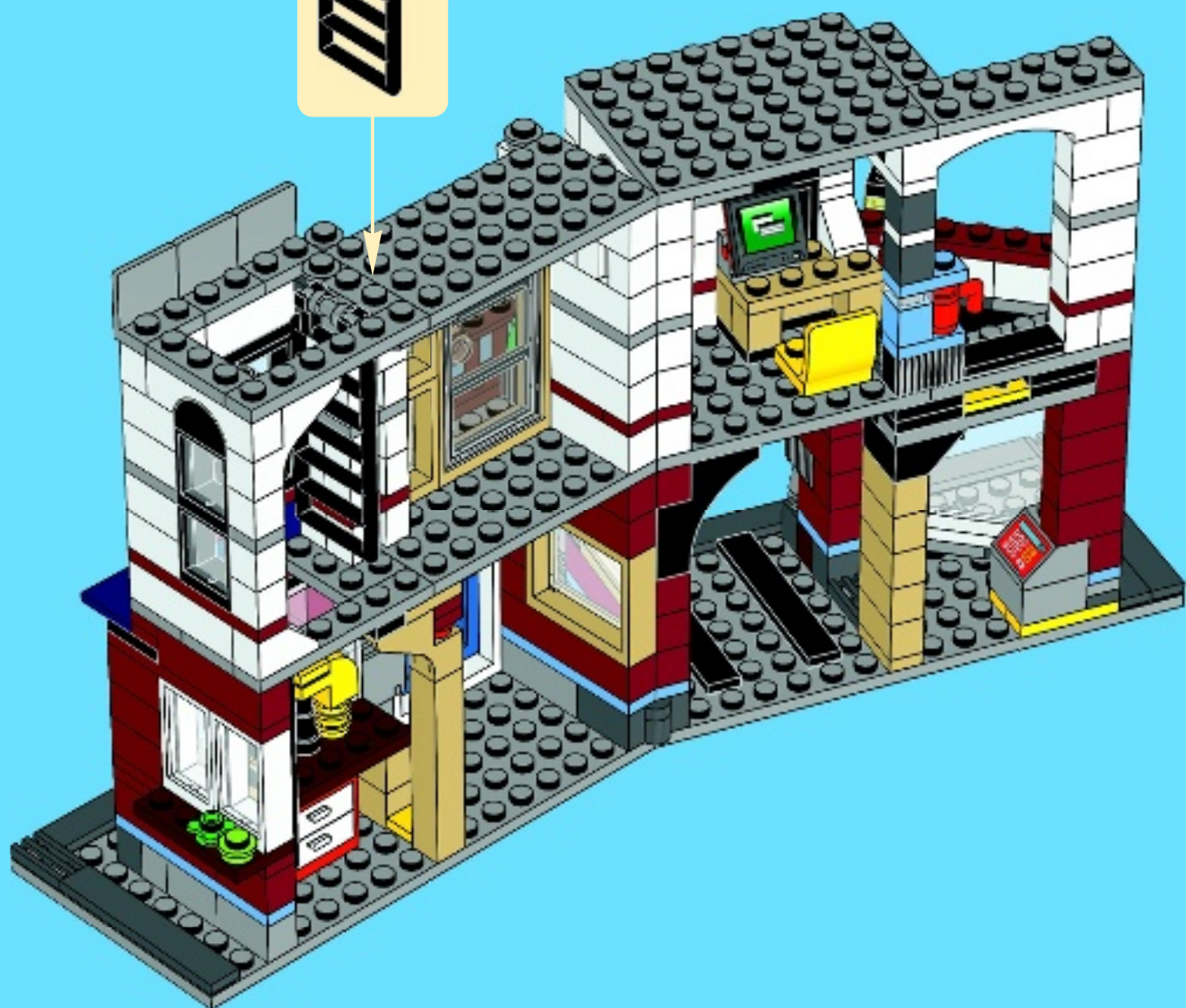
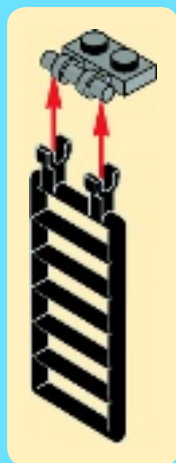



1x



2x



1x



1x



1x

55

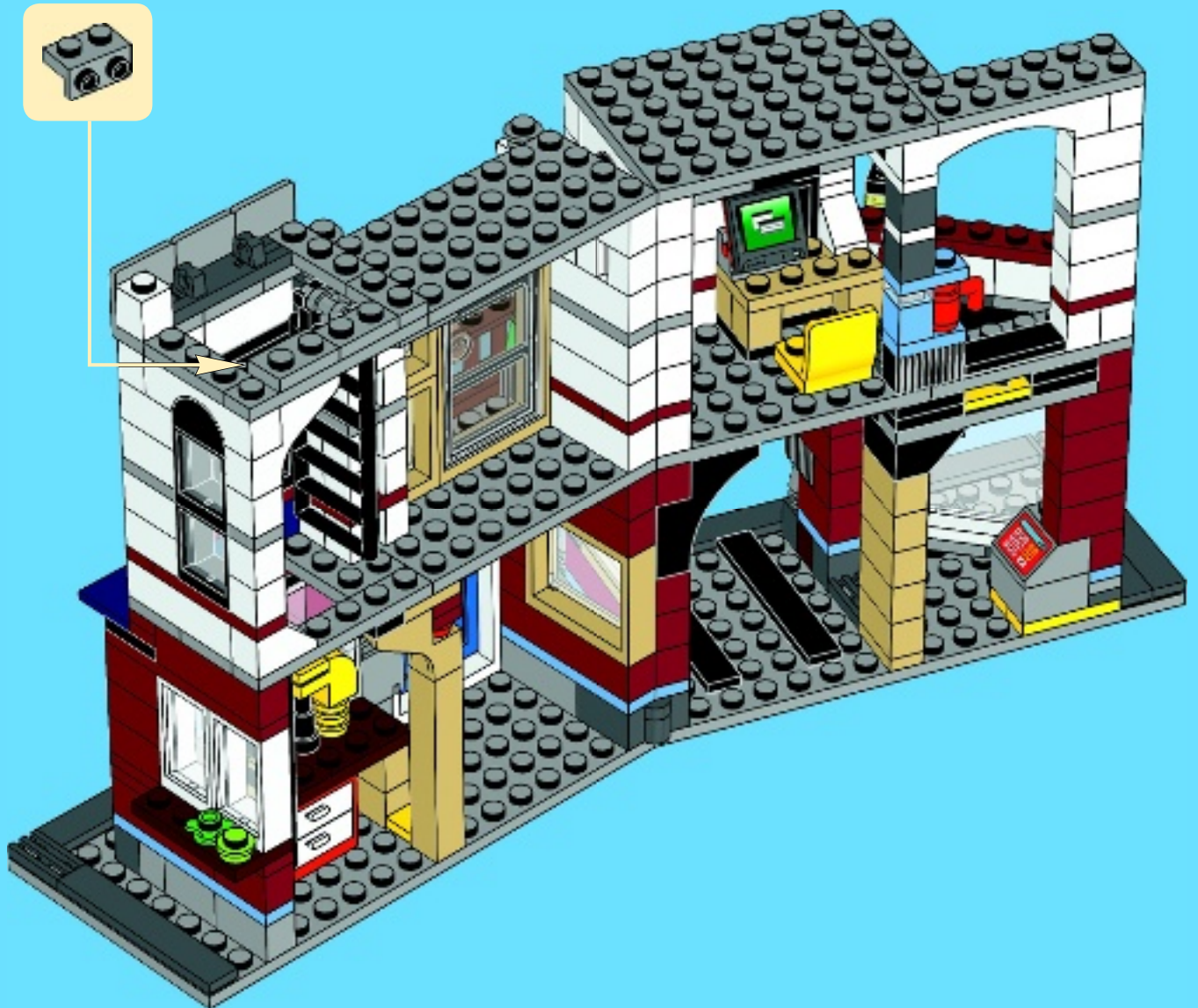

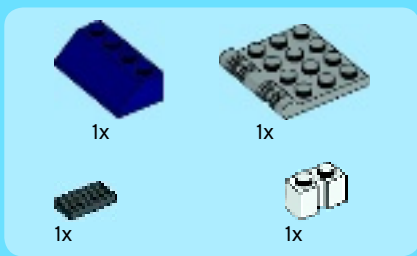

56

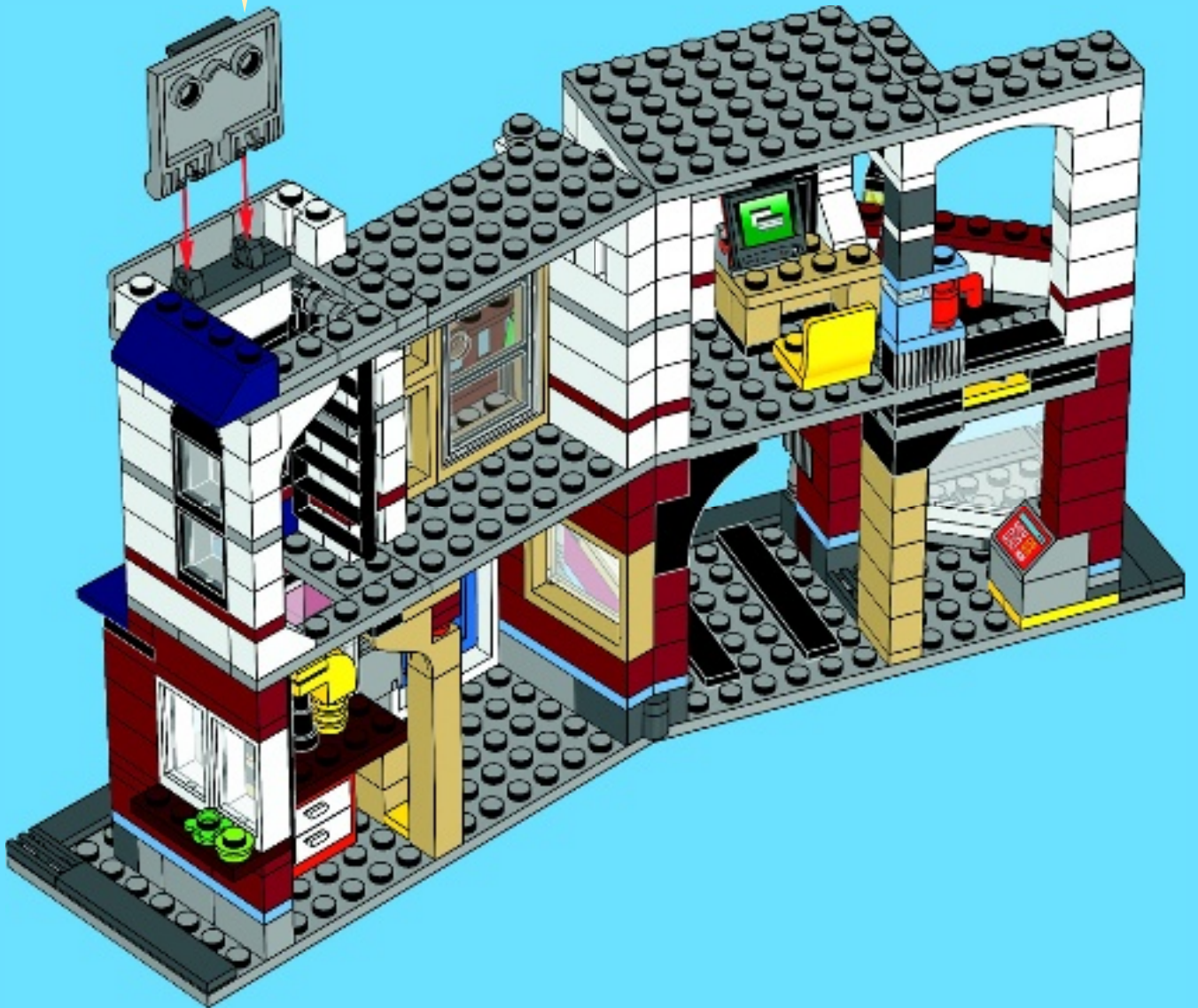
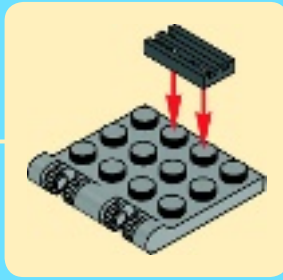

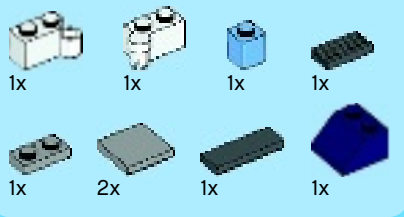

57

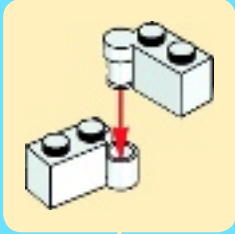



6x



1x



1x

58

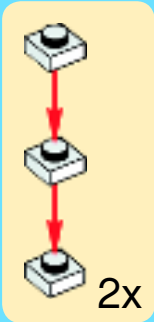

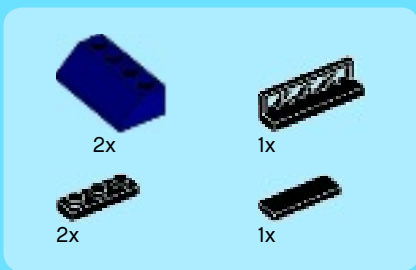

59

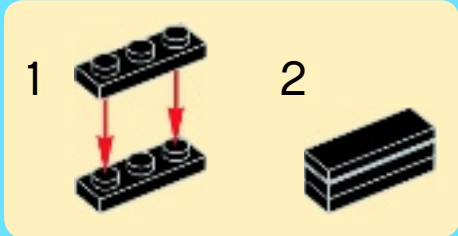



2x



1x



4x

60



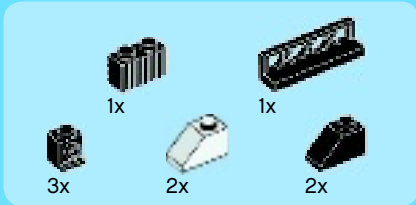

61

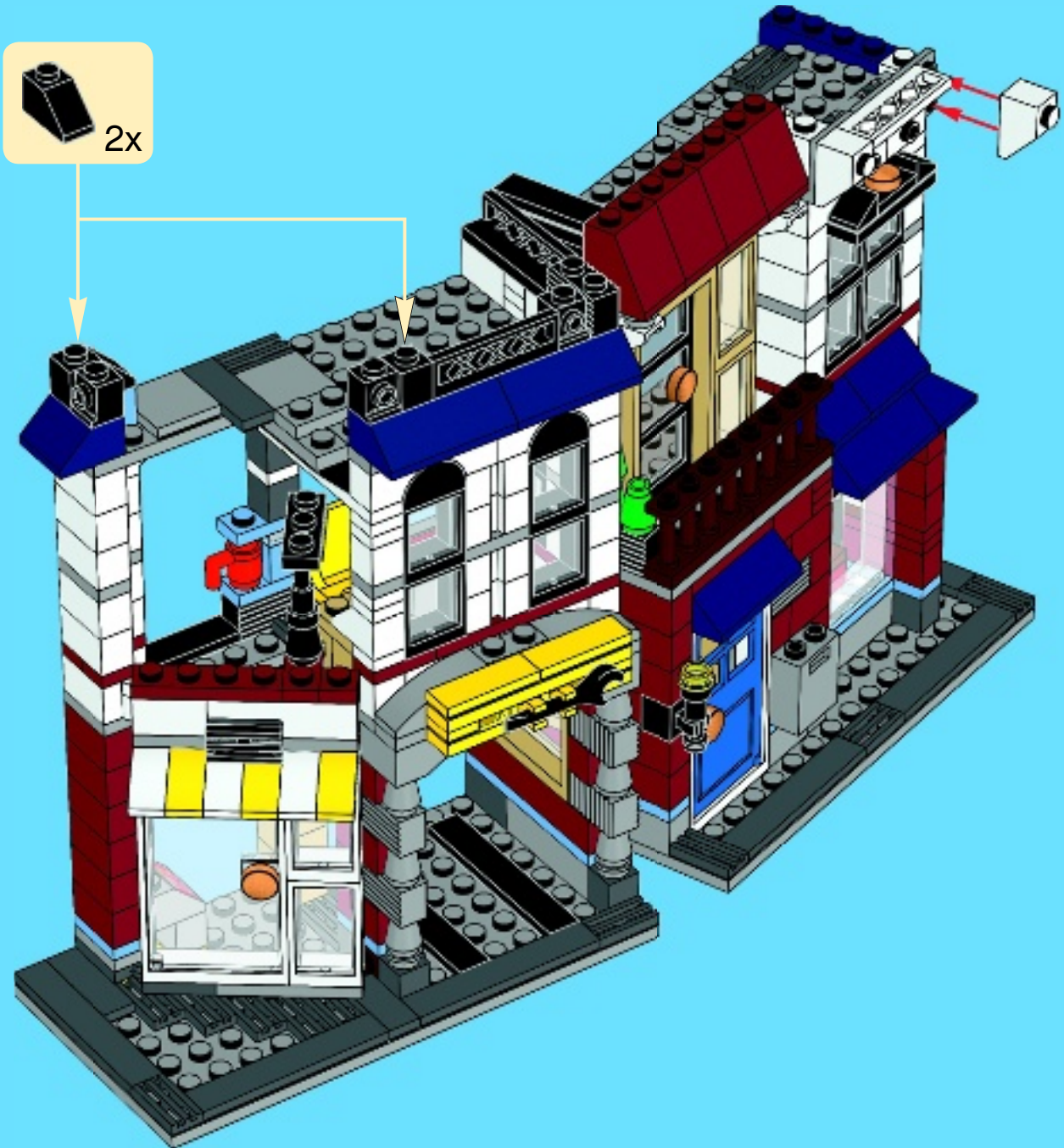



1x

1

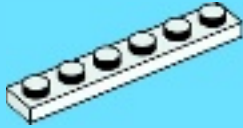

2x



1x

2

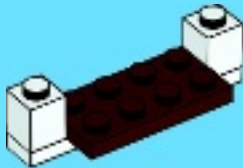

1x



2x



1x

3



1x



1x

4



2x



2x

5

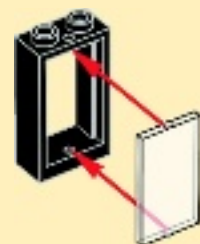

2x





4x



4x



2x

6

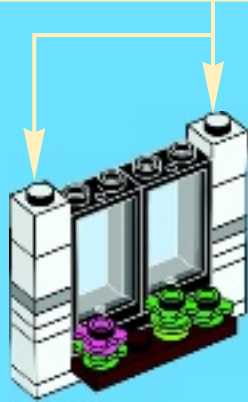
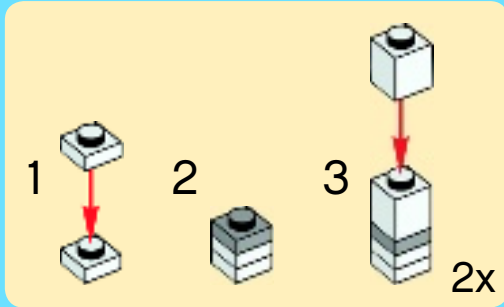

1x



1x



1x



2x

7

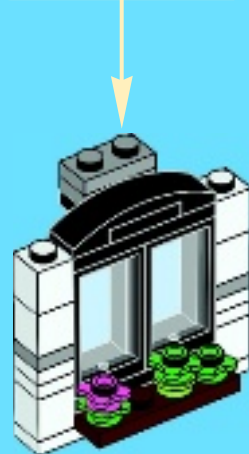
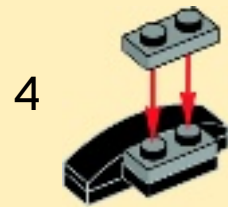



1x

8



4x

9



1x

10



1x



1x

11



2x



1x

12



62



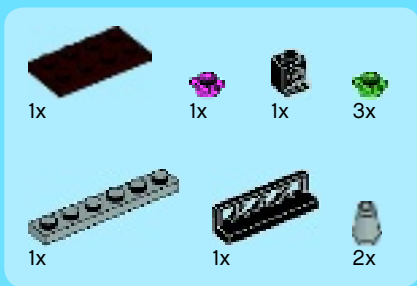

63

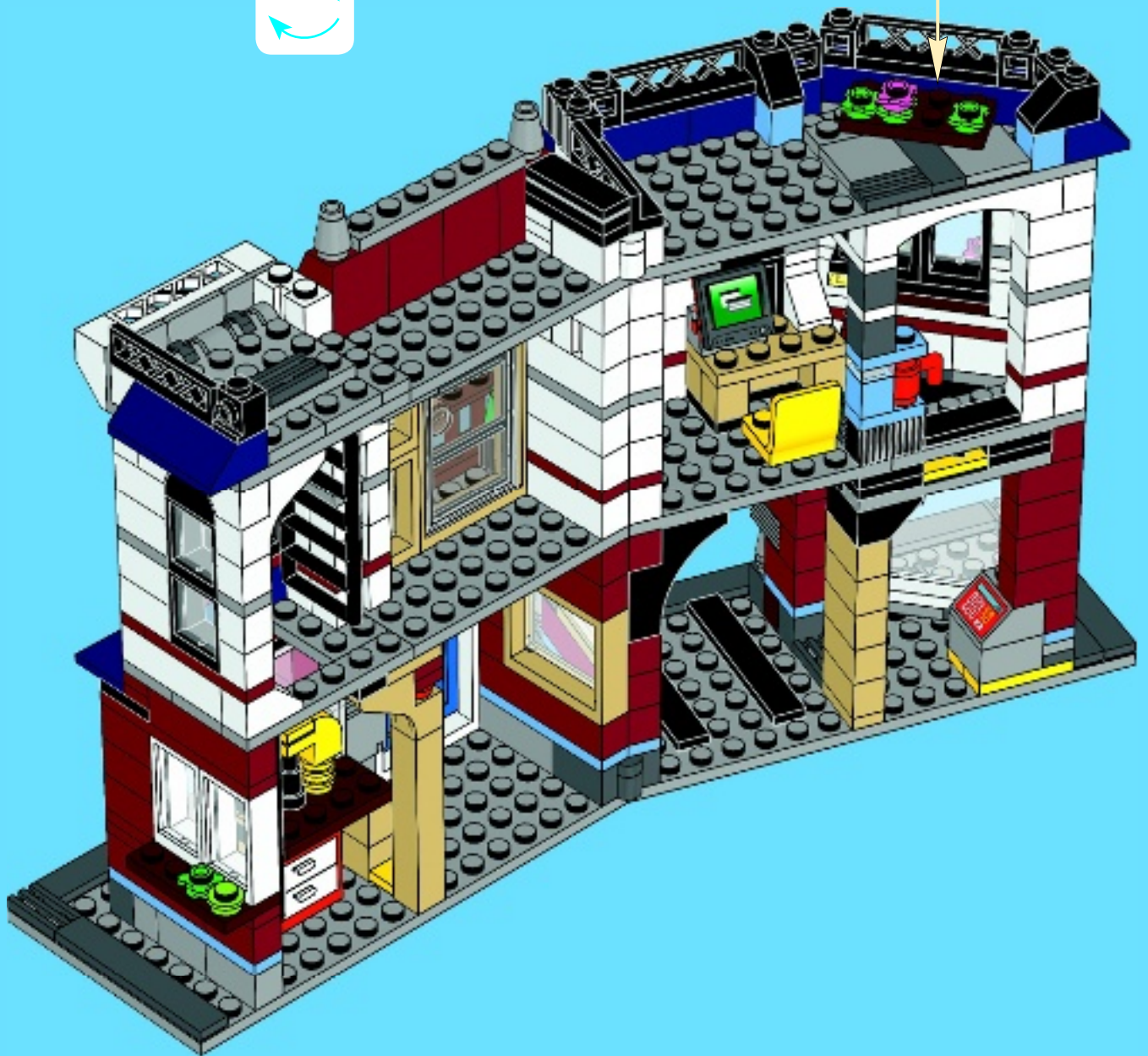



1

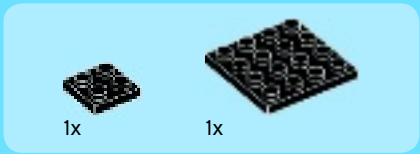

2

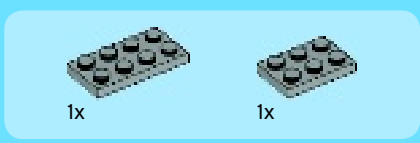
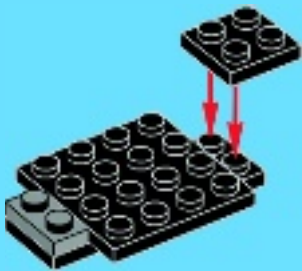

3

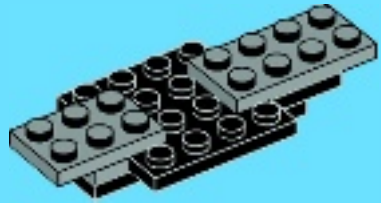

4

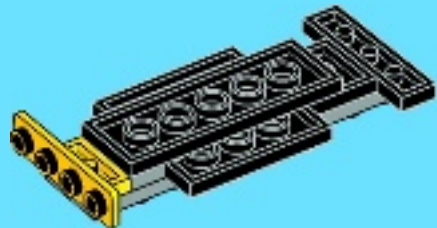



1x



2x



1x

5

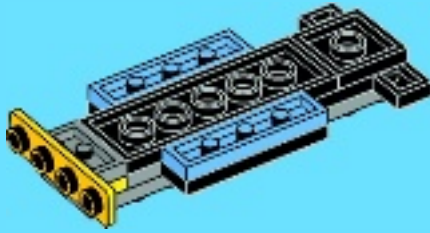

2x



2x

6

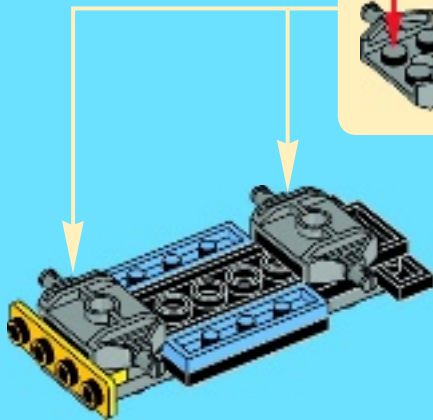
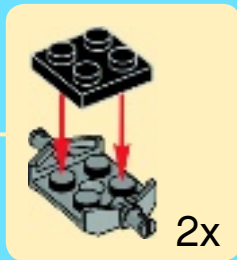

1x



1x



1x

7

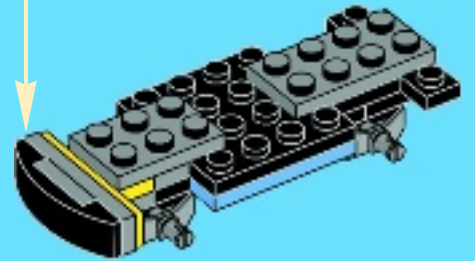
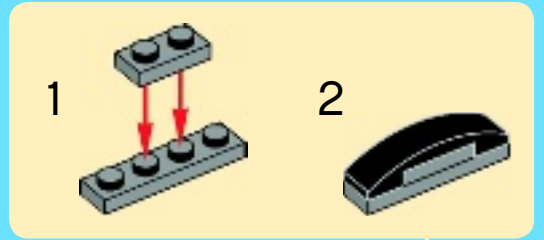

1x



1x

8

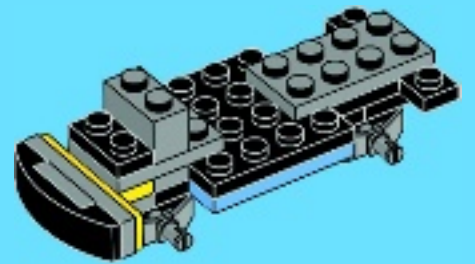



1x



1x

9

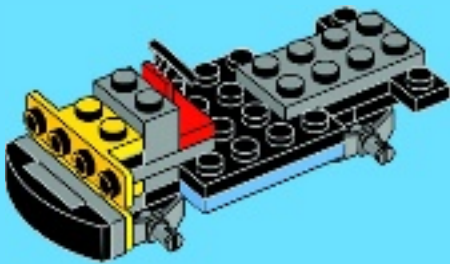

1x



2x



1x

10

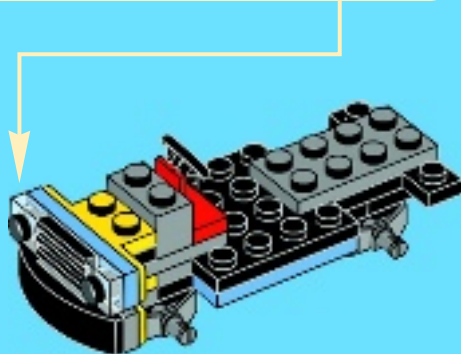
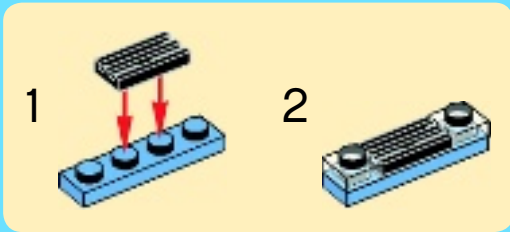

4x

11

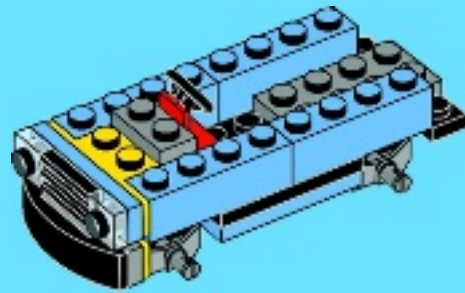

2x



2x

12



2x

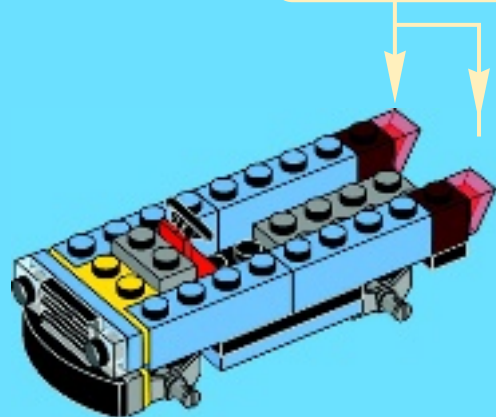



1x



2x

13

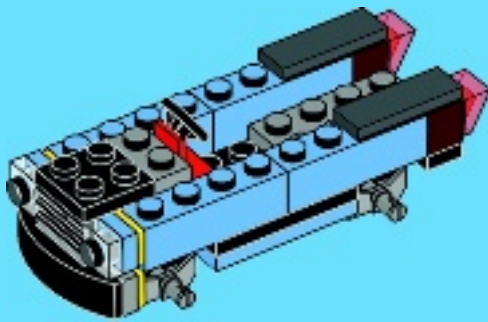

2x



2x

14

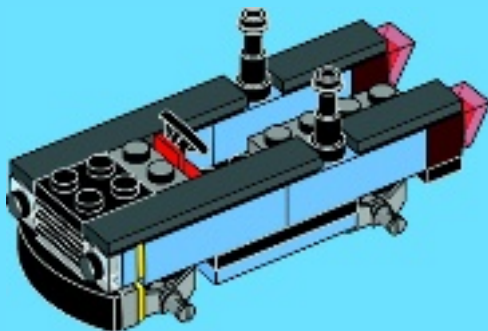

2x



1x



1x

15

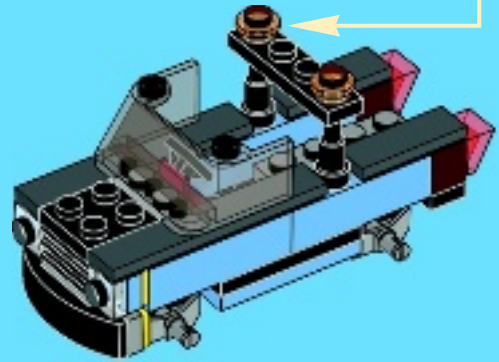
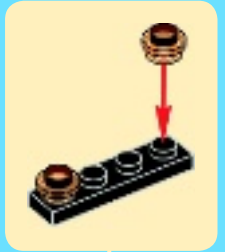

4x



4x

16

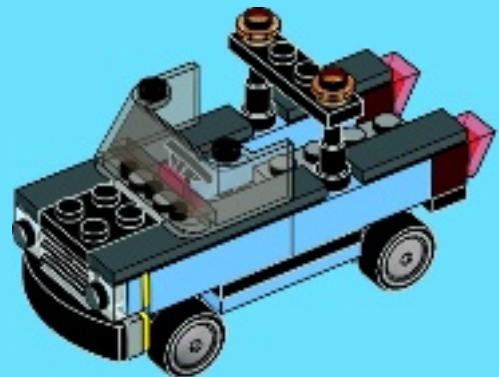

64

