



NINJAGO

Mas



9446



CONVERTS

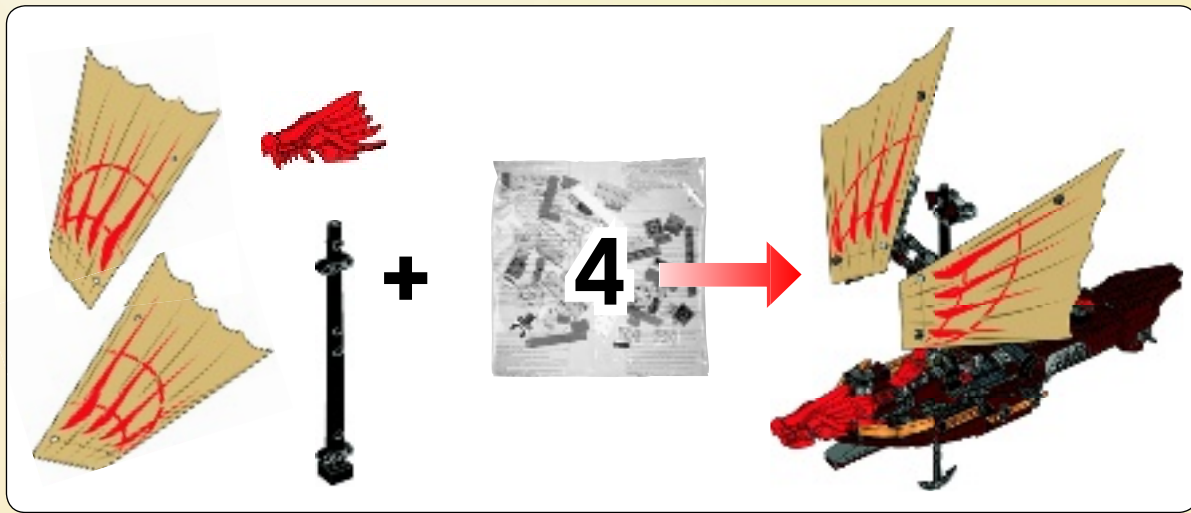

CONVERTS
 TRANSFORMIERBAR
 TRANSFORMATION
 CONVERTIBLE
 CONVERTÍVEL
 ÁTALAKÍTHATÓ

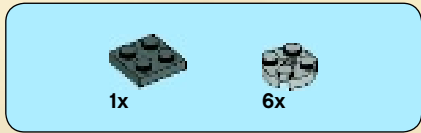

55

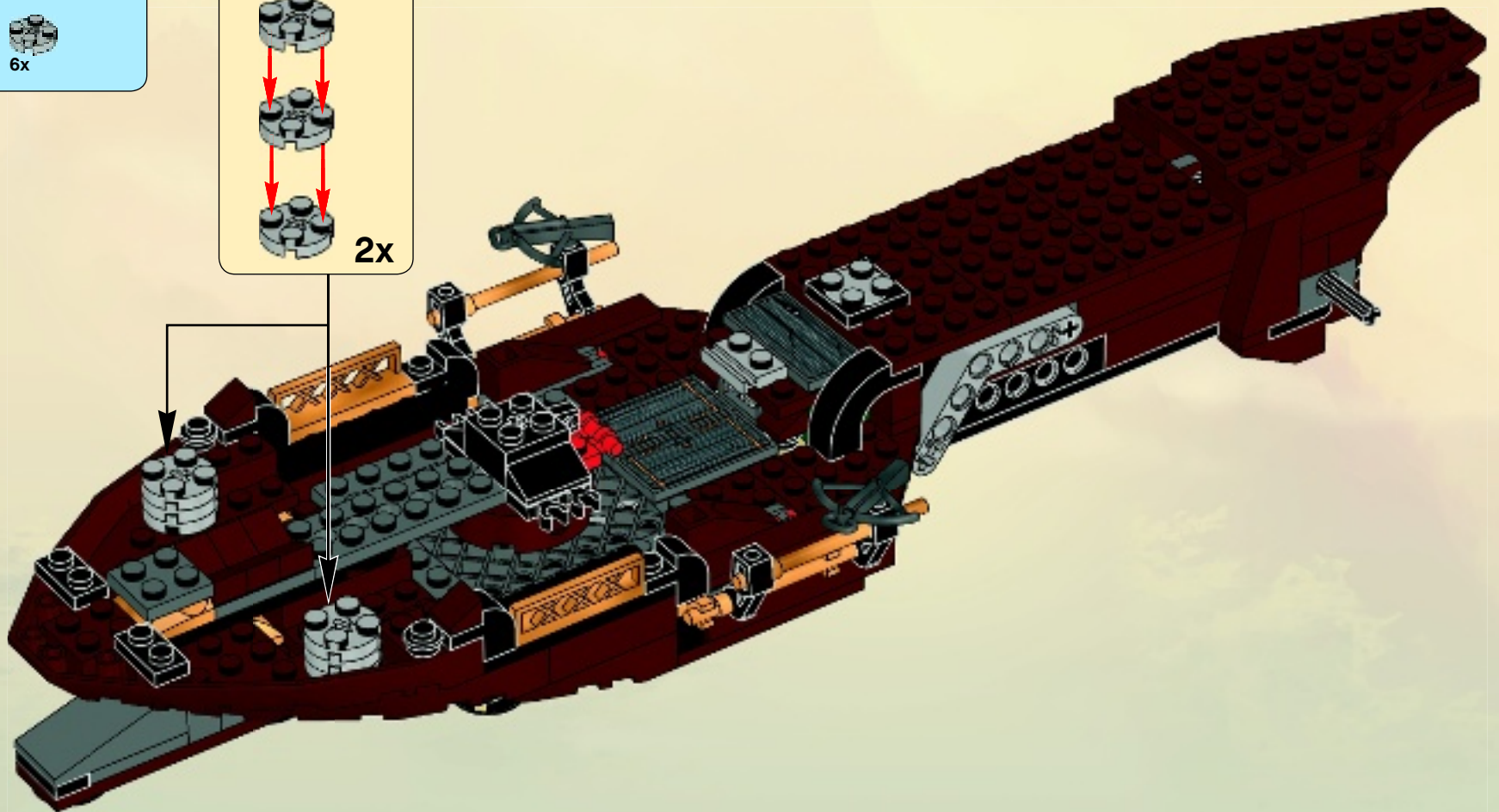
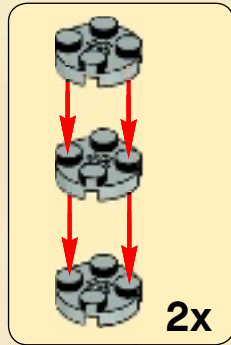

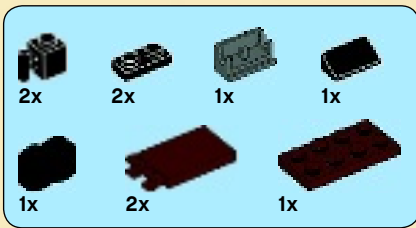

56

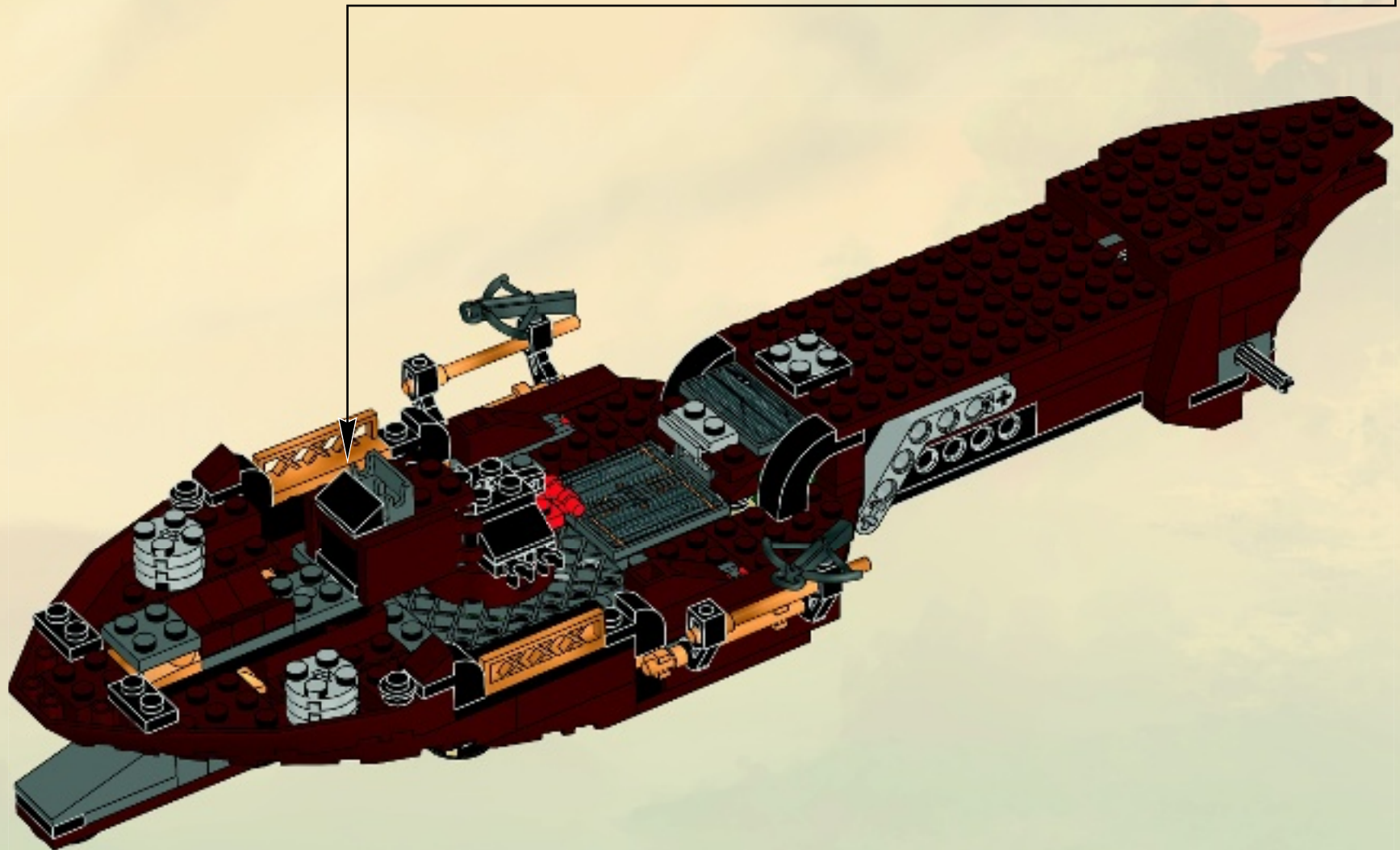

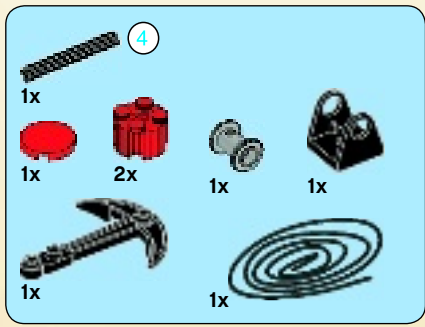

57

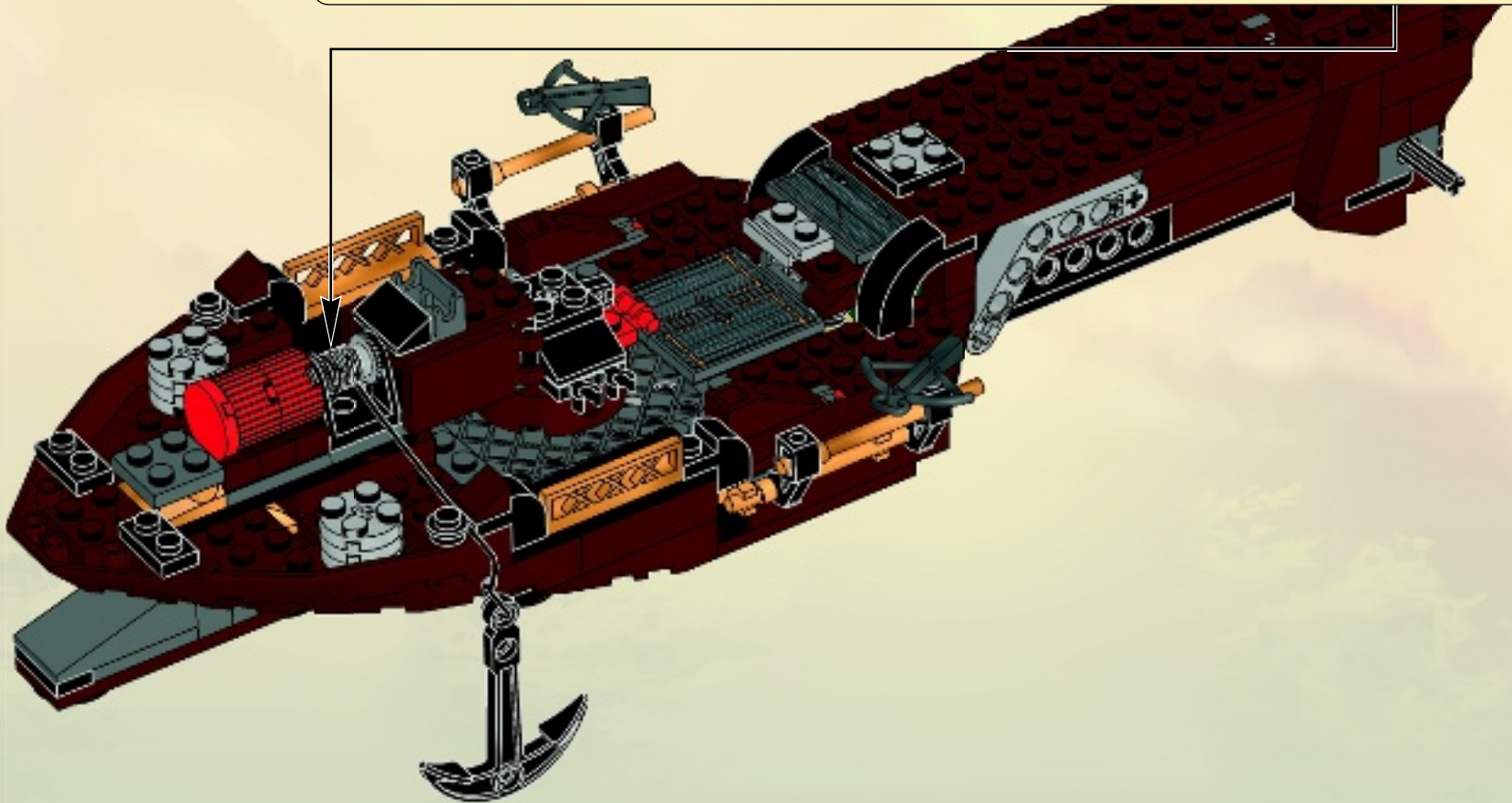
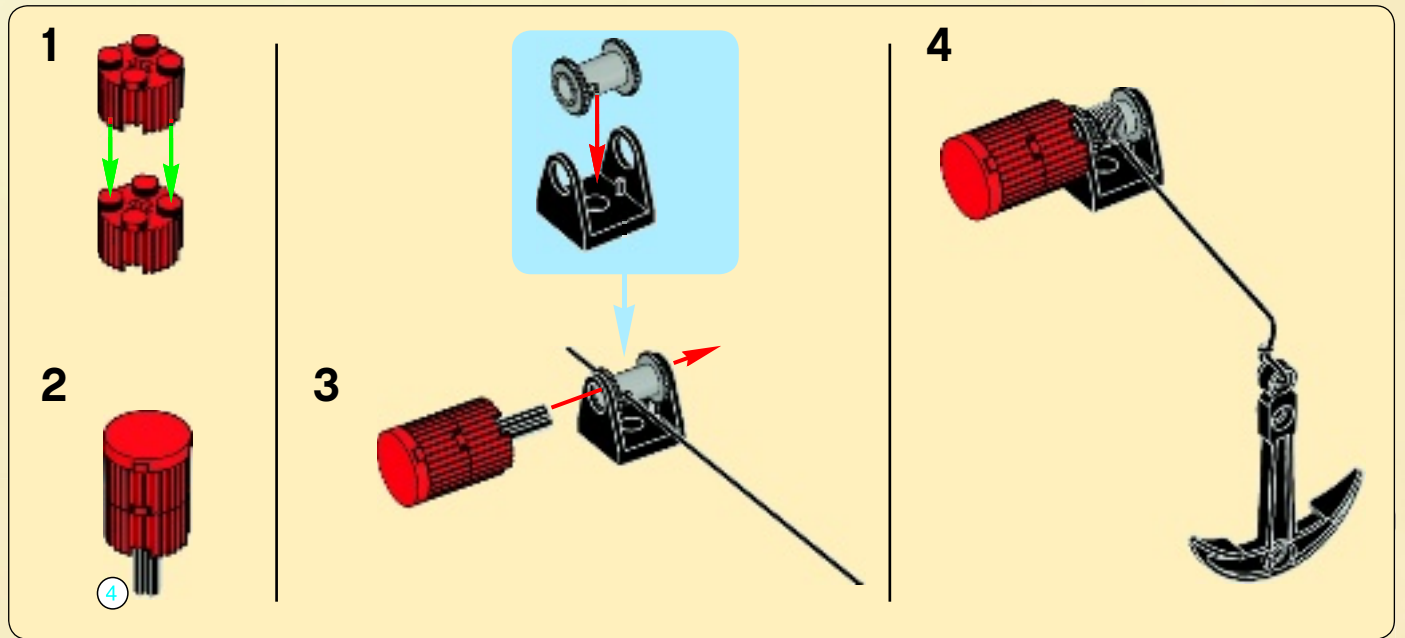

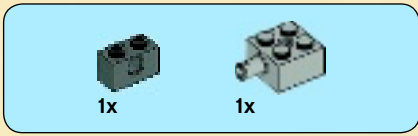
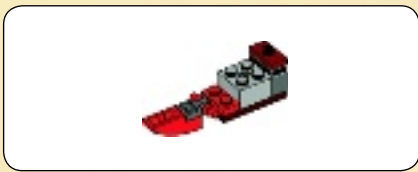

1

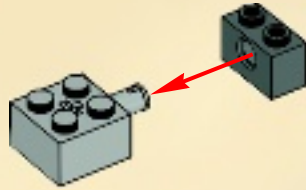

2

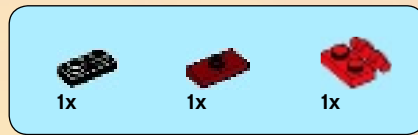
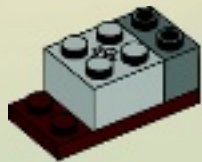

3

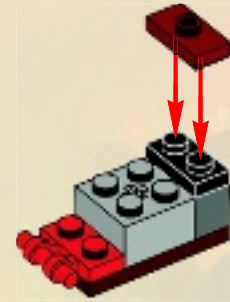

4

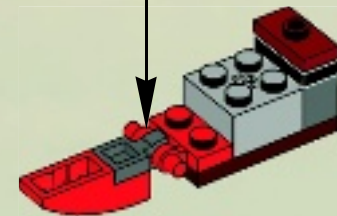

58

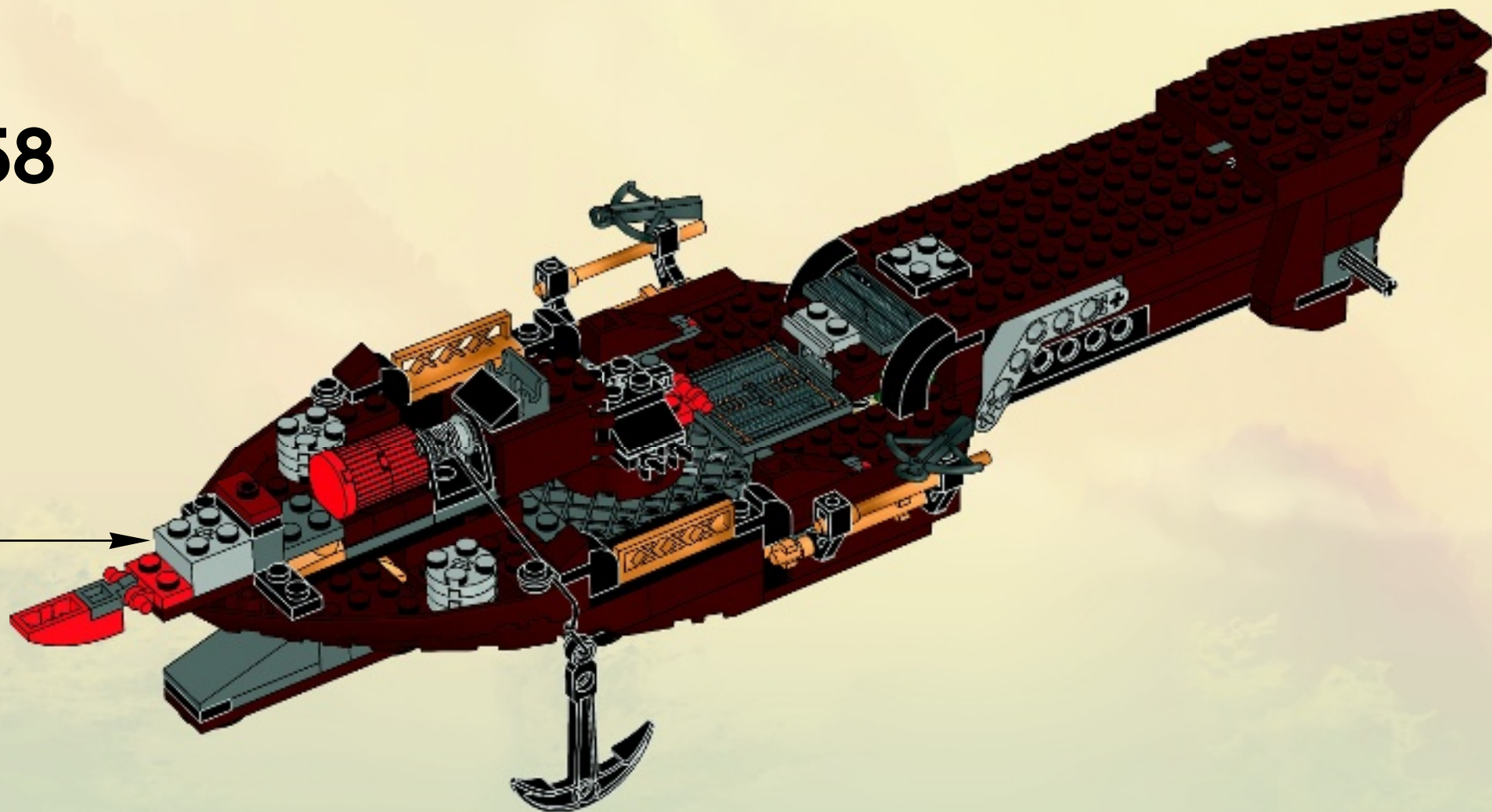

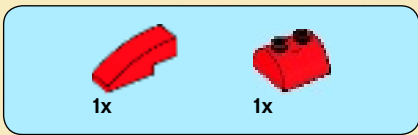

59

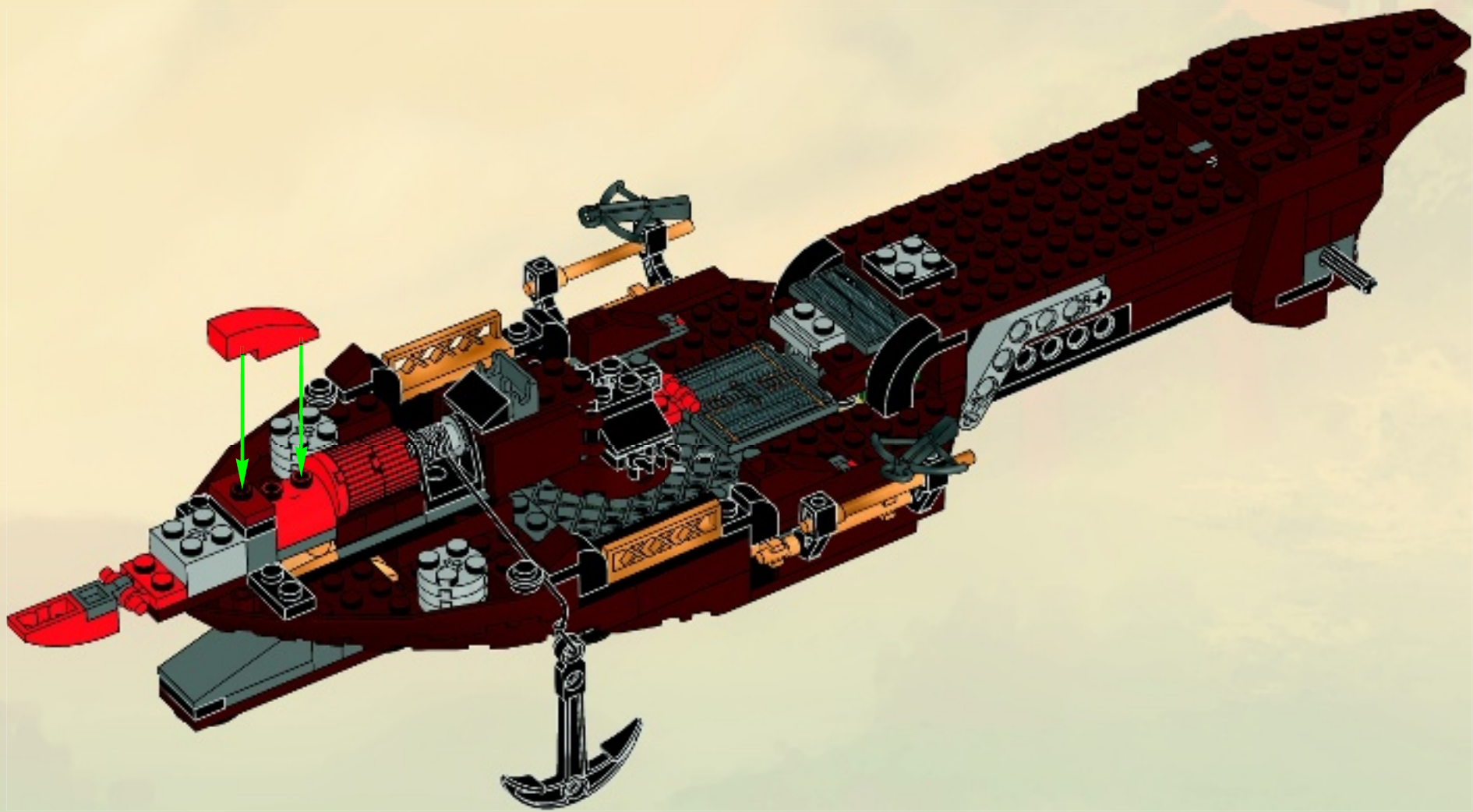

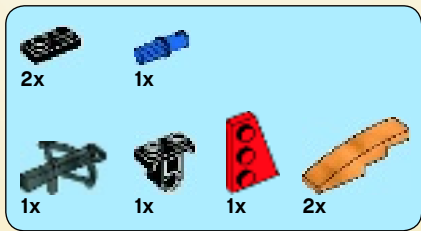

60

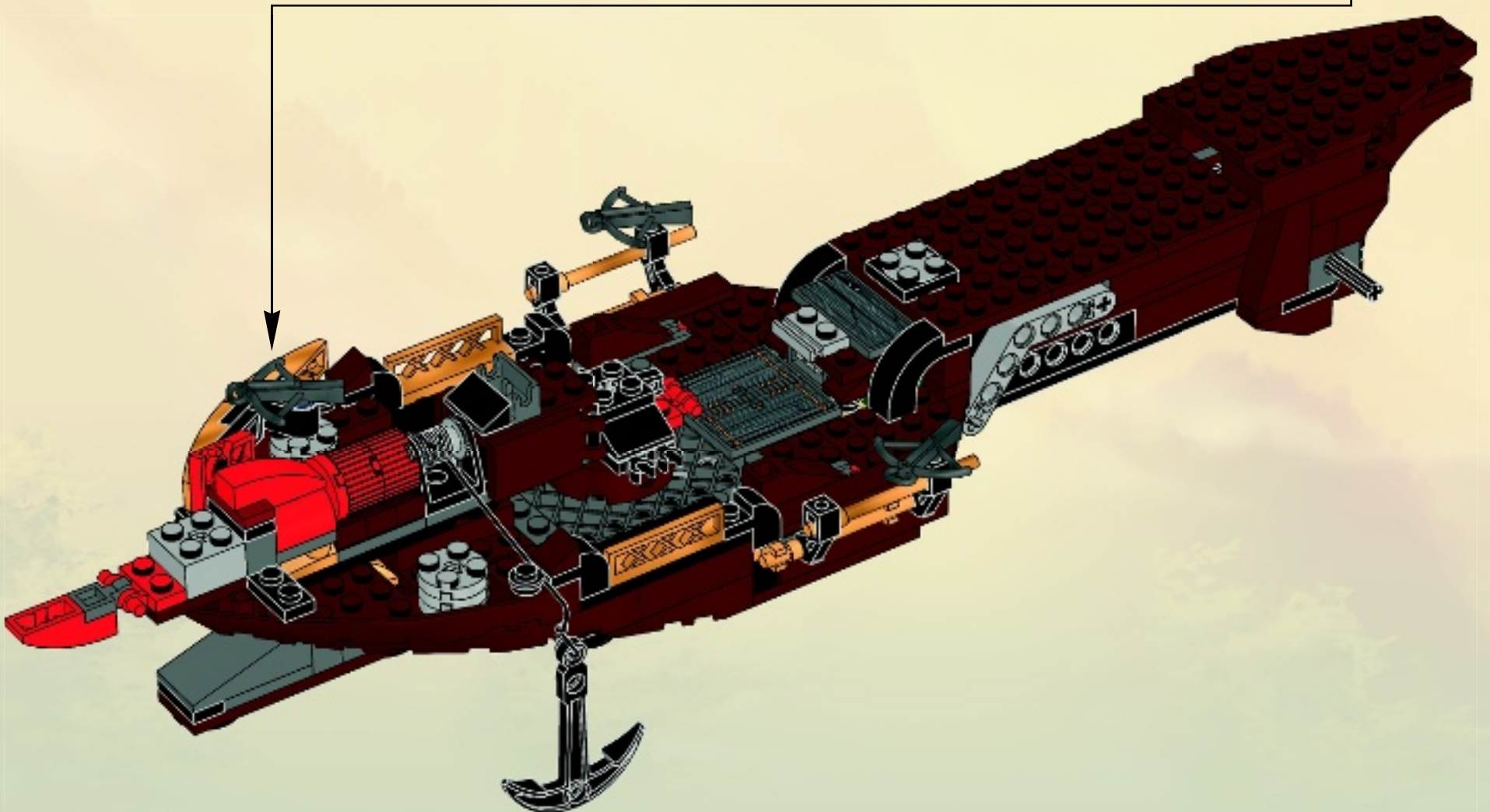
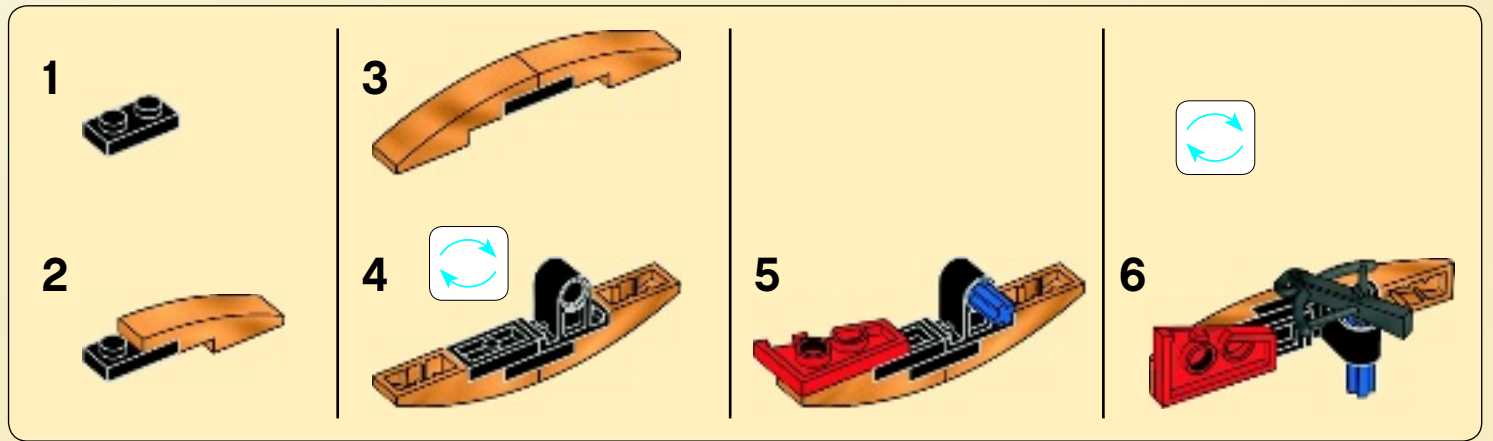

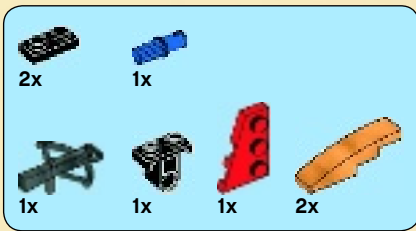

61

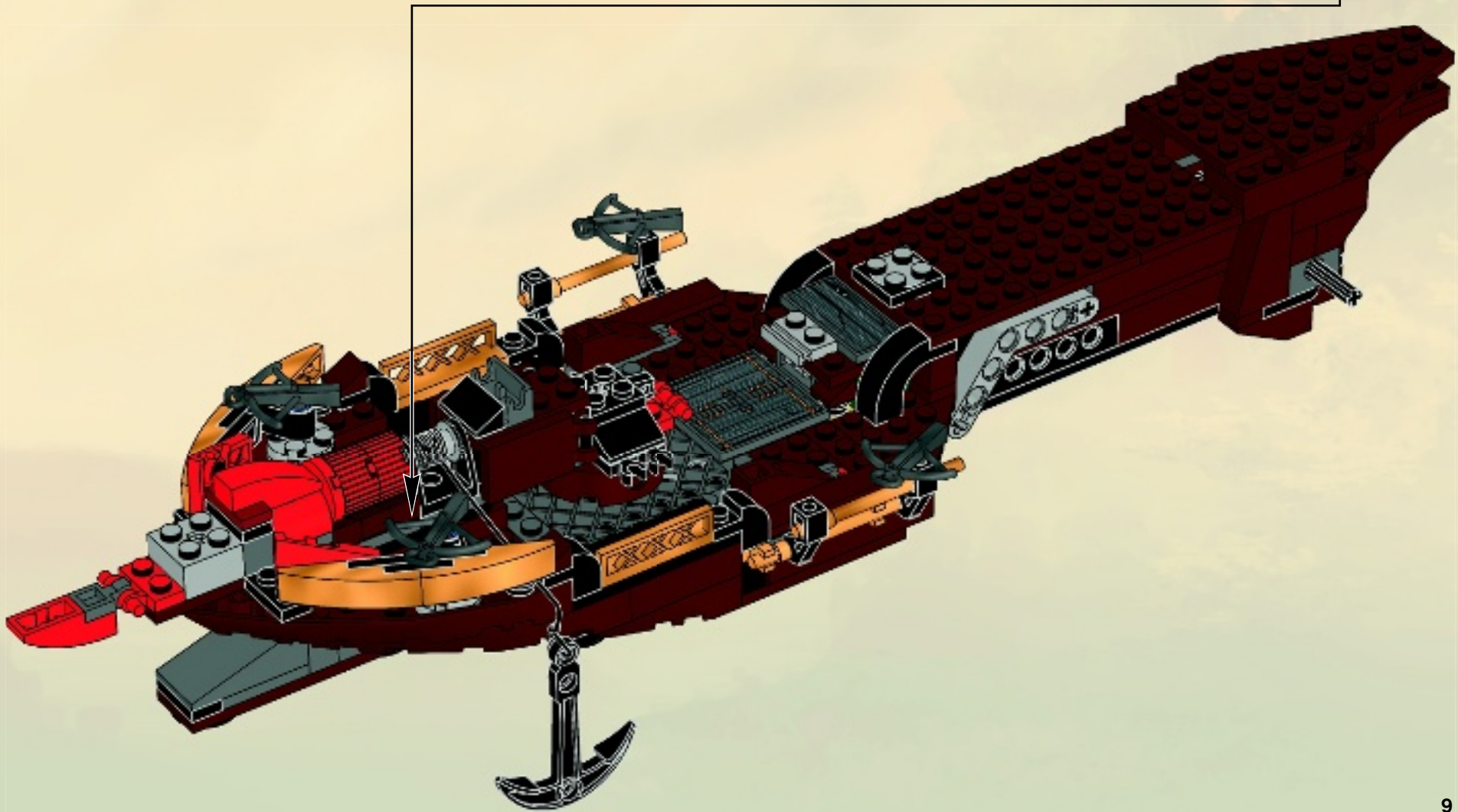
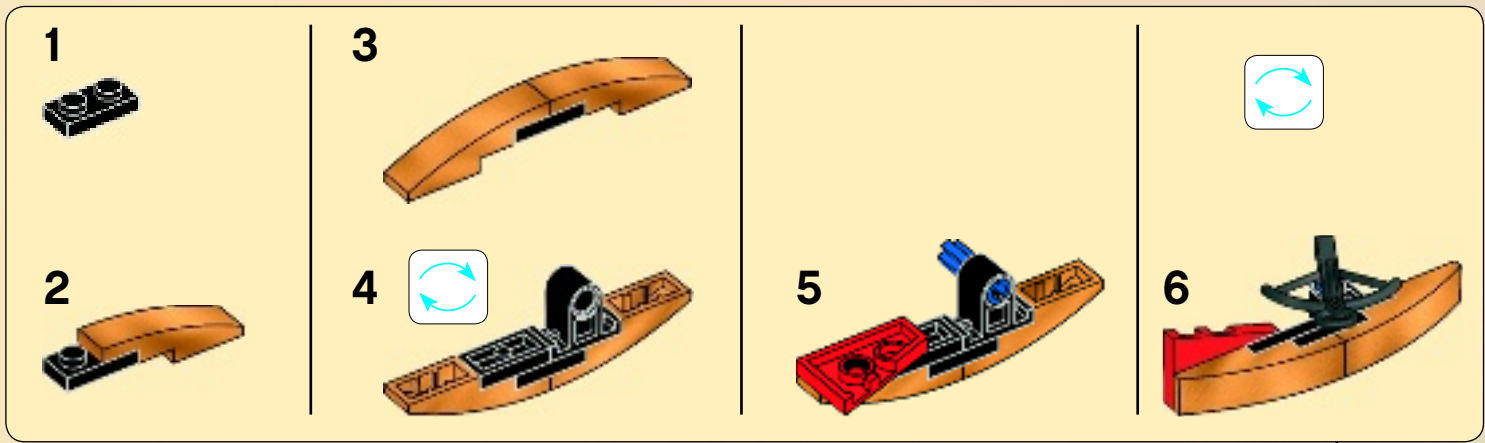

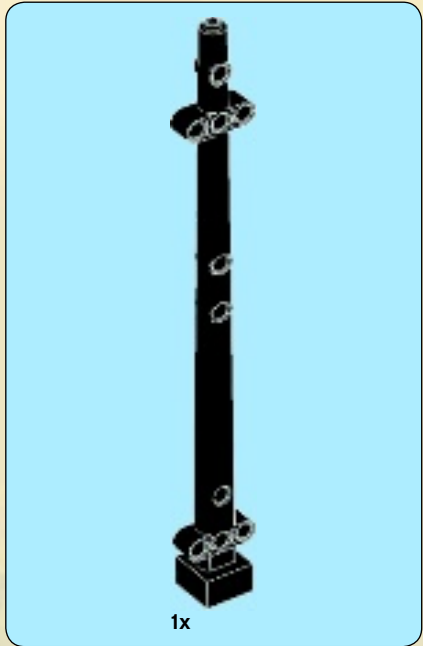

1

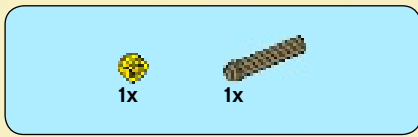

2





3

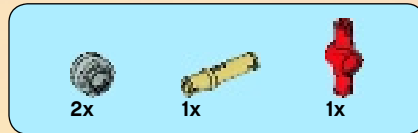

4

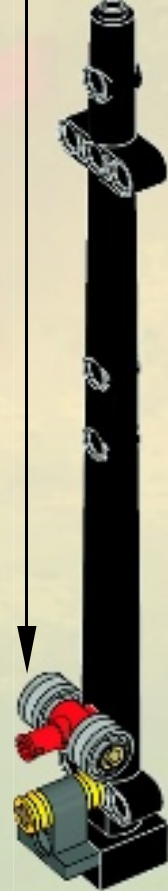
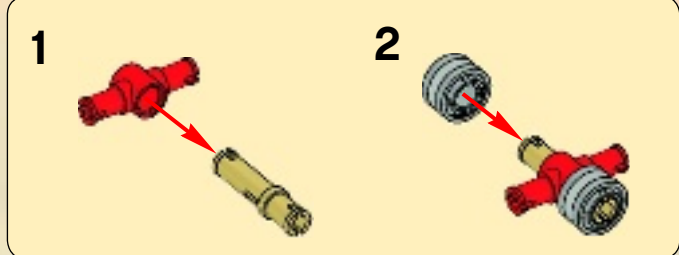



5

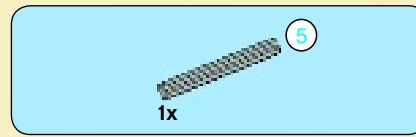
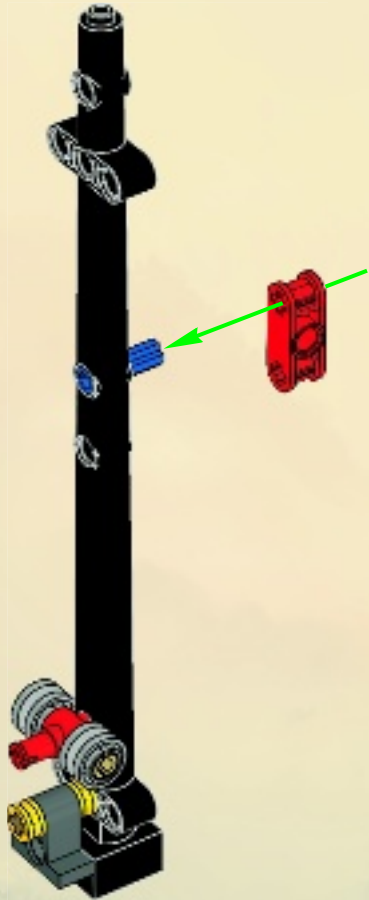

6



62

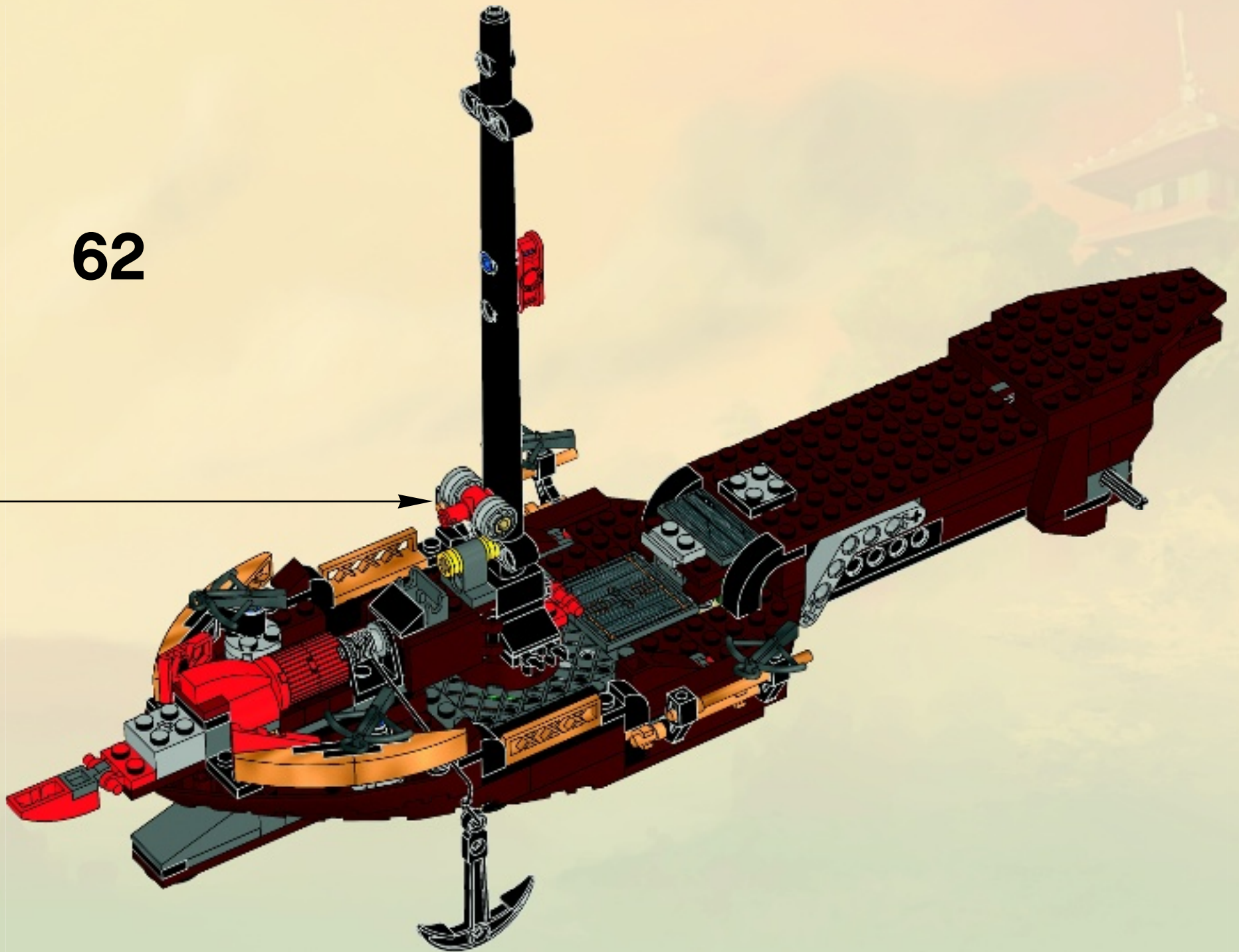

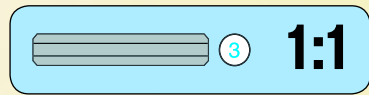
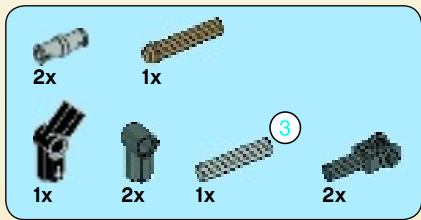

63

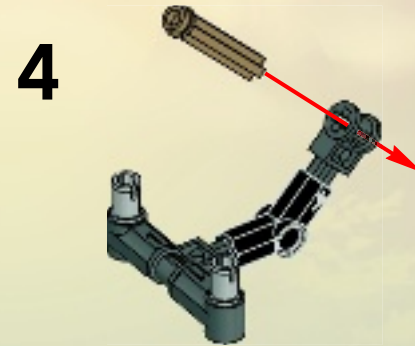
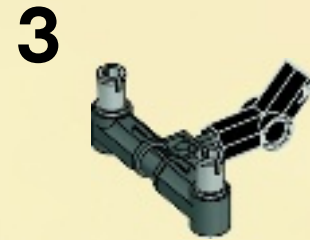
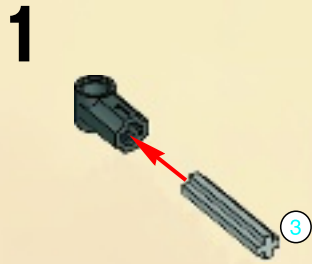

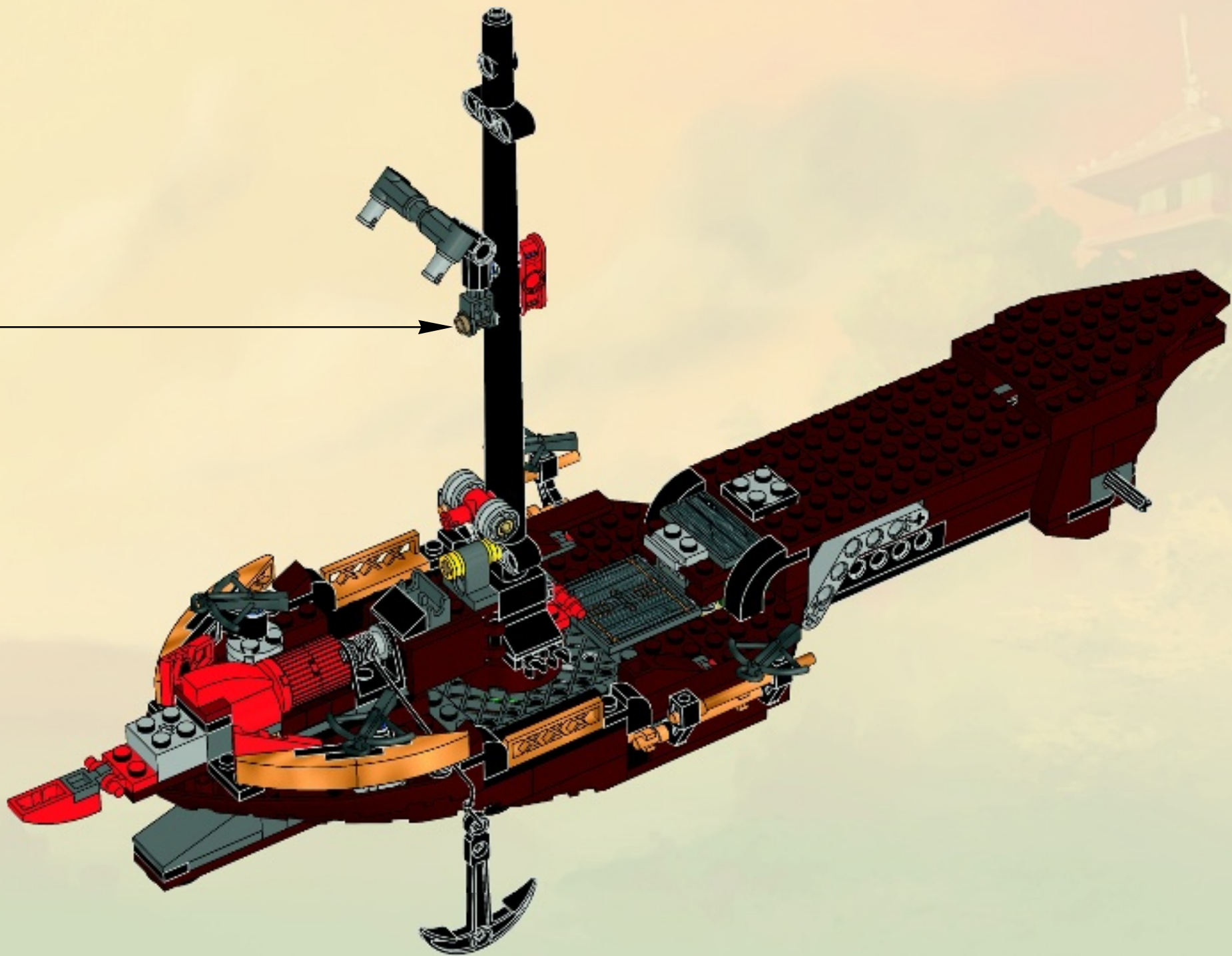



64

1

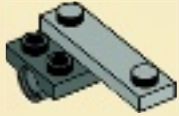

2



3



4

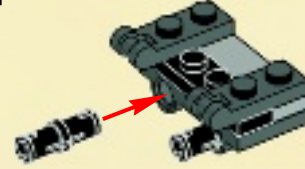

5



6

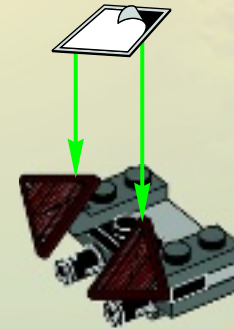

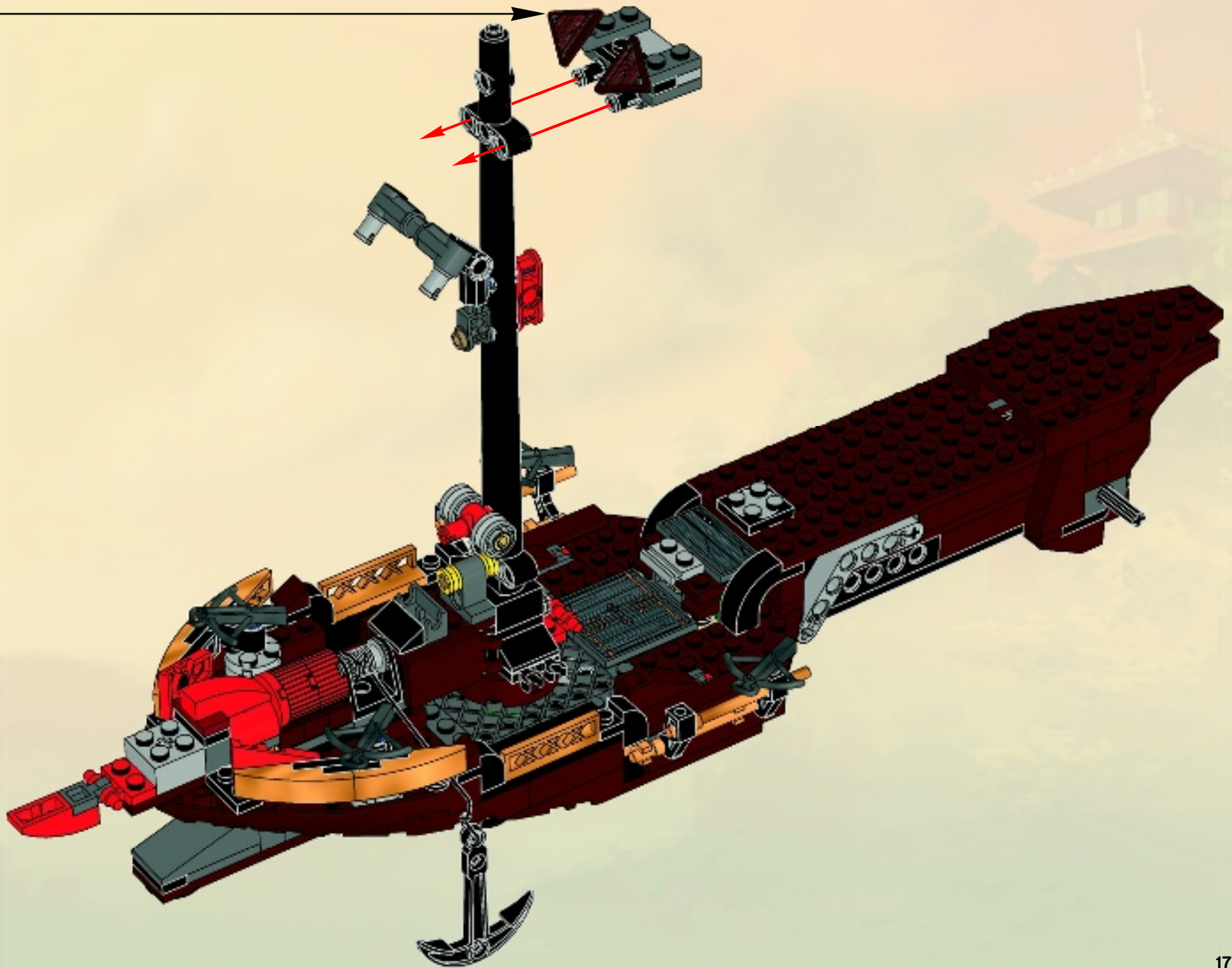

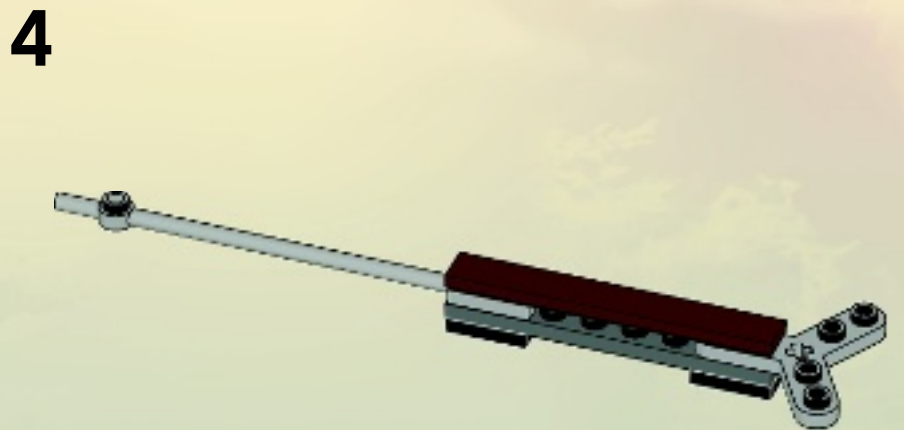
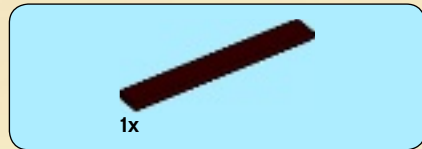
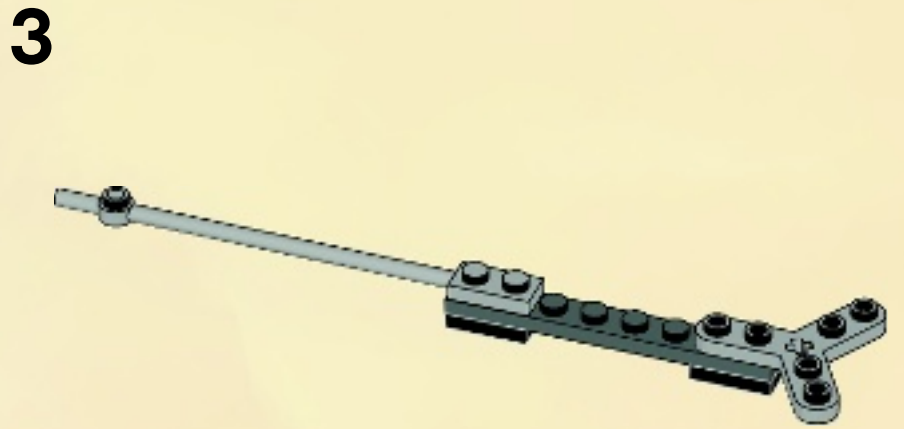
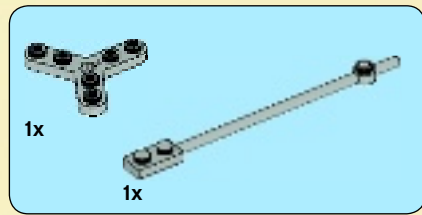
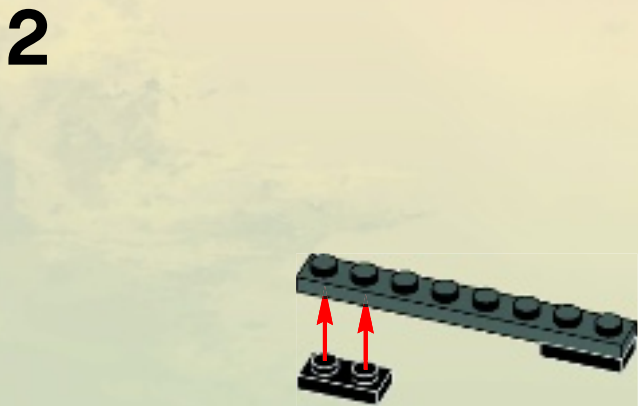
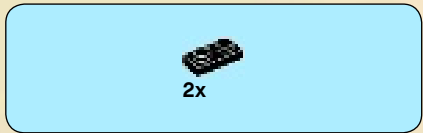
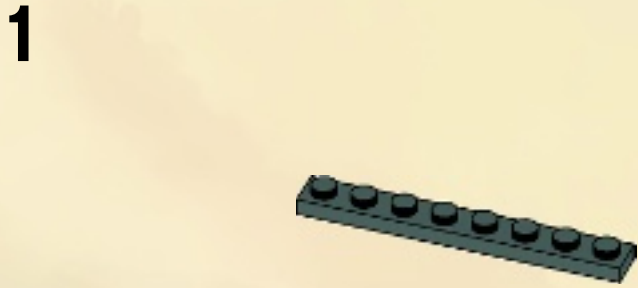
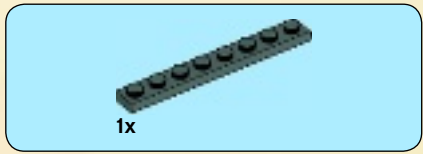

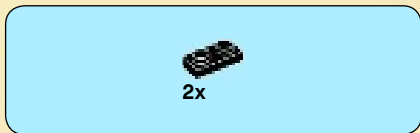

5

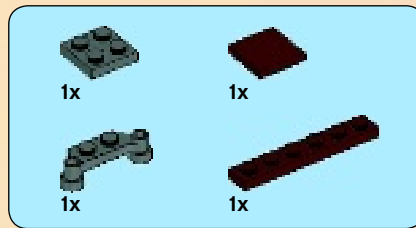
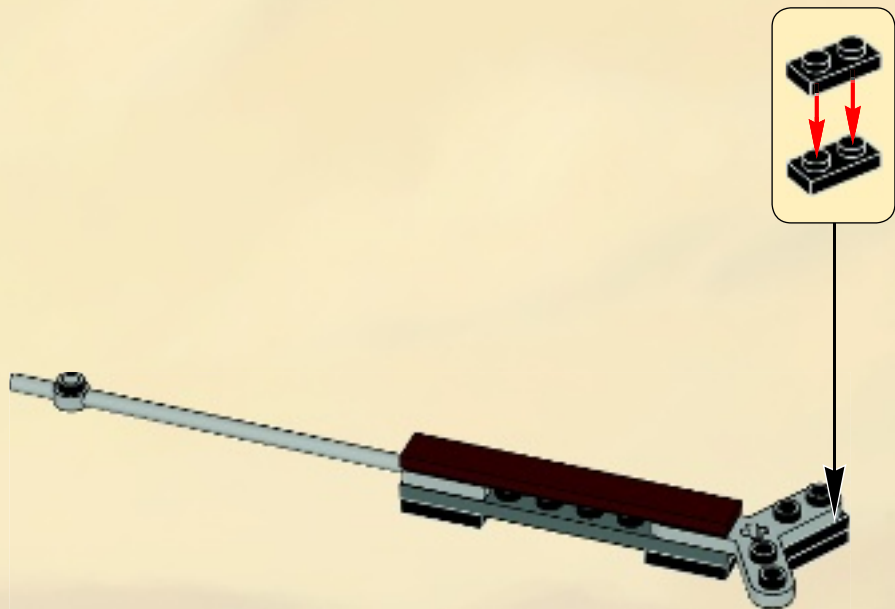

6





7

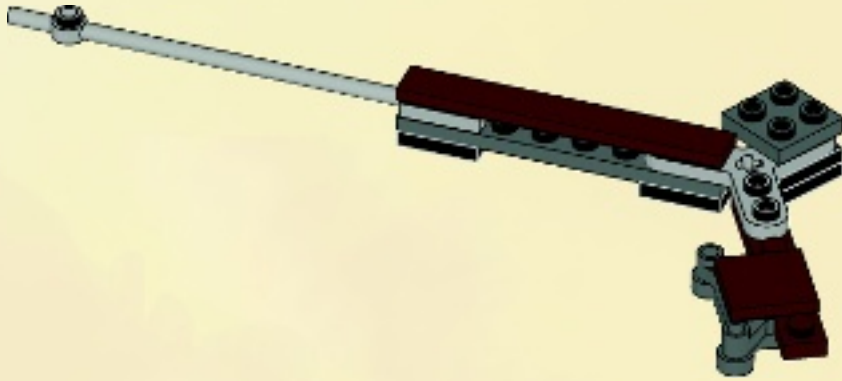

8

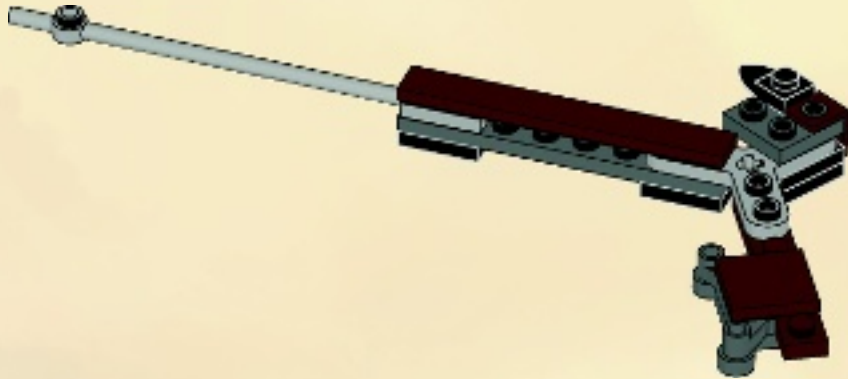

9

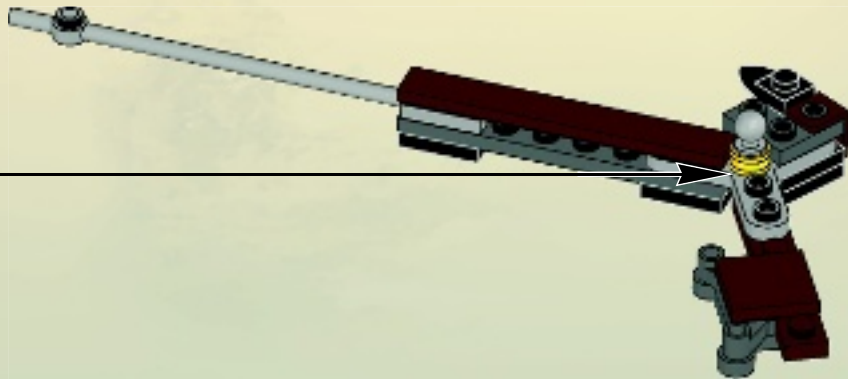
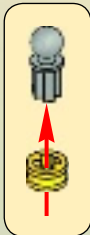

65

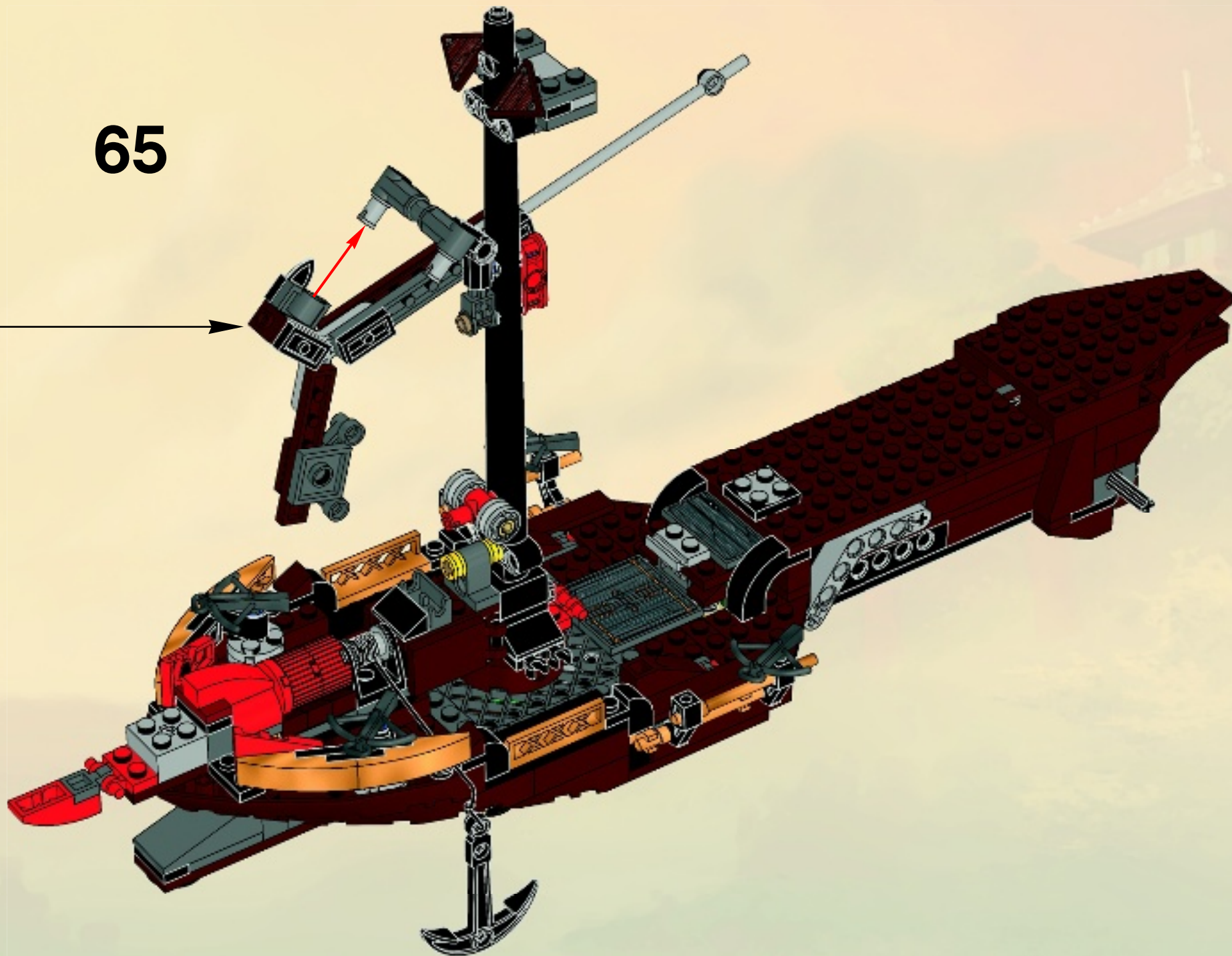

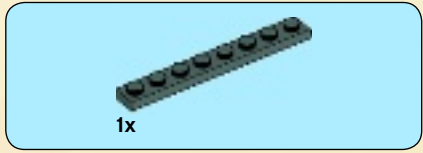

1

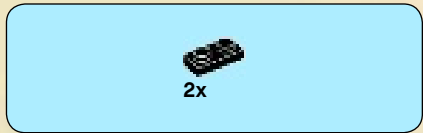

2

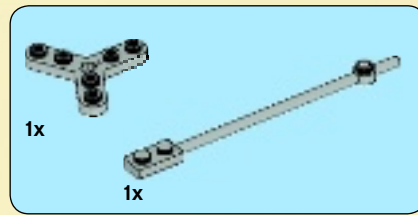

3

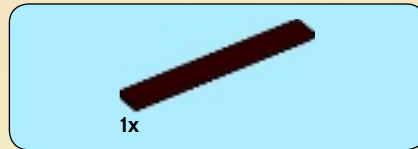
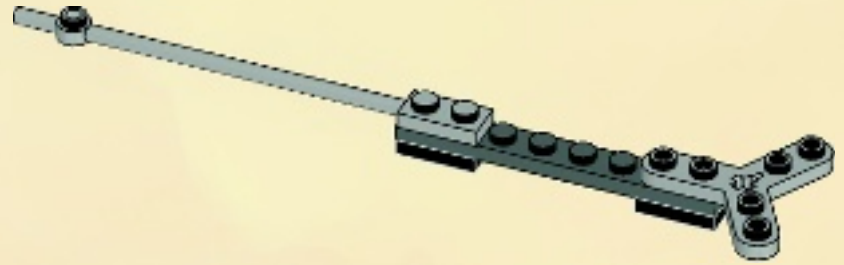

4



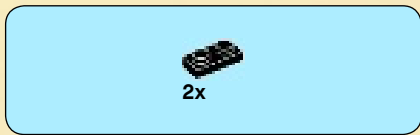

5

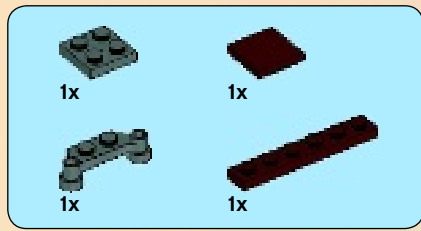
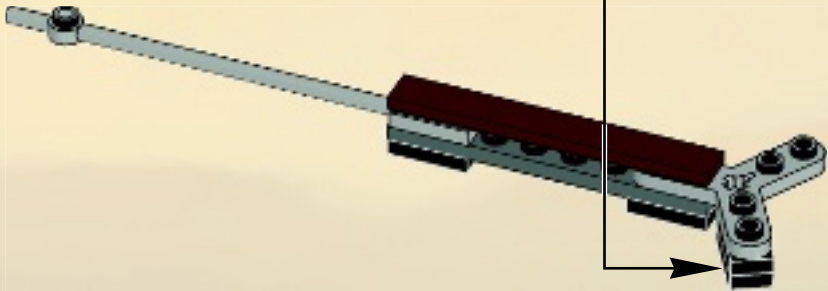
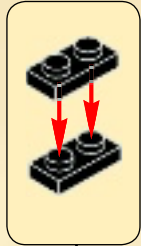

6

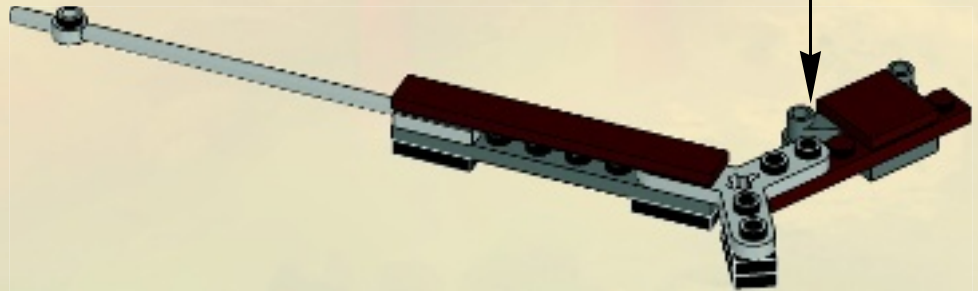
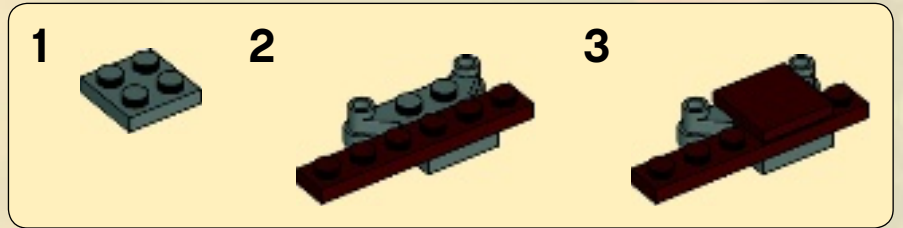



7

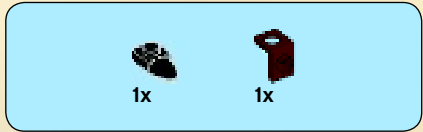
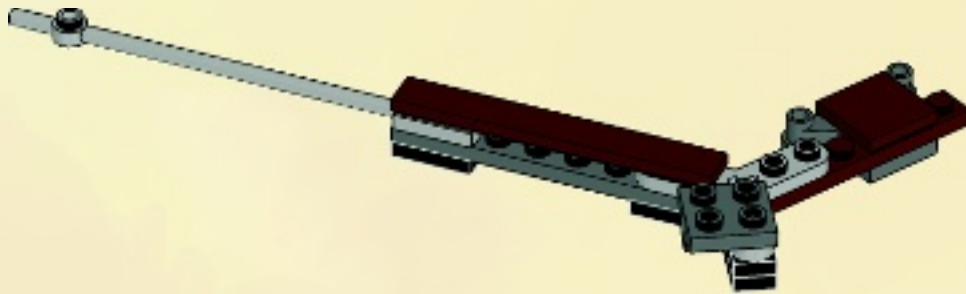

8

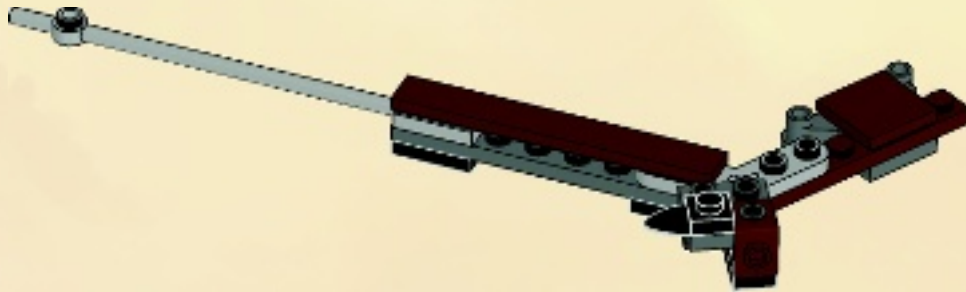

9

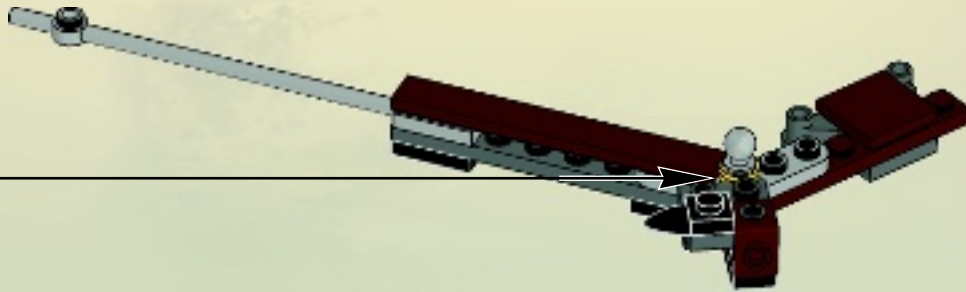
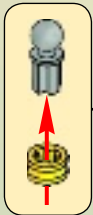

66

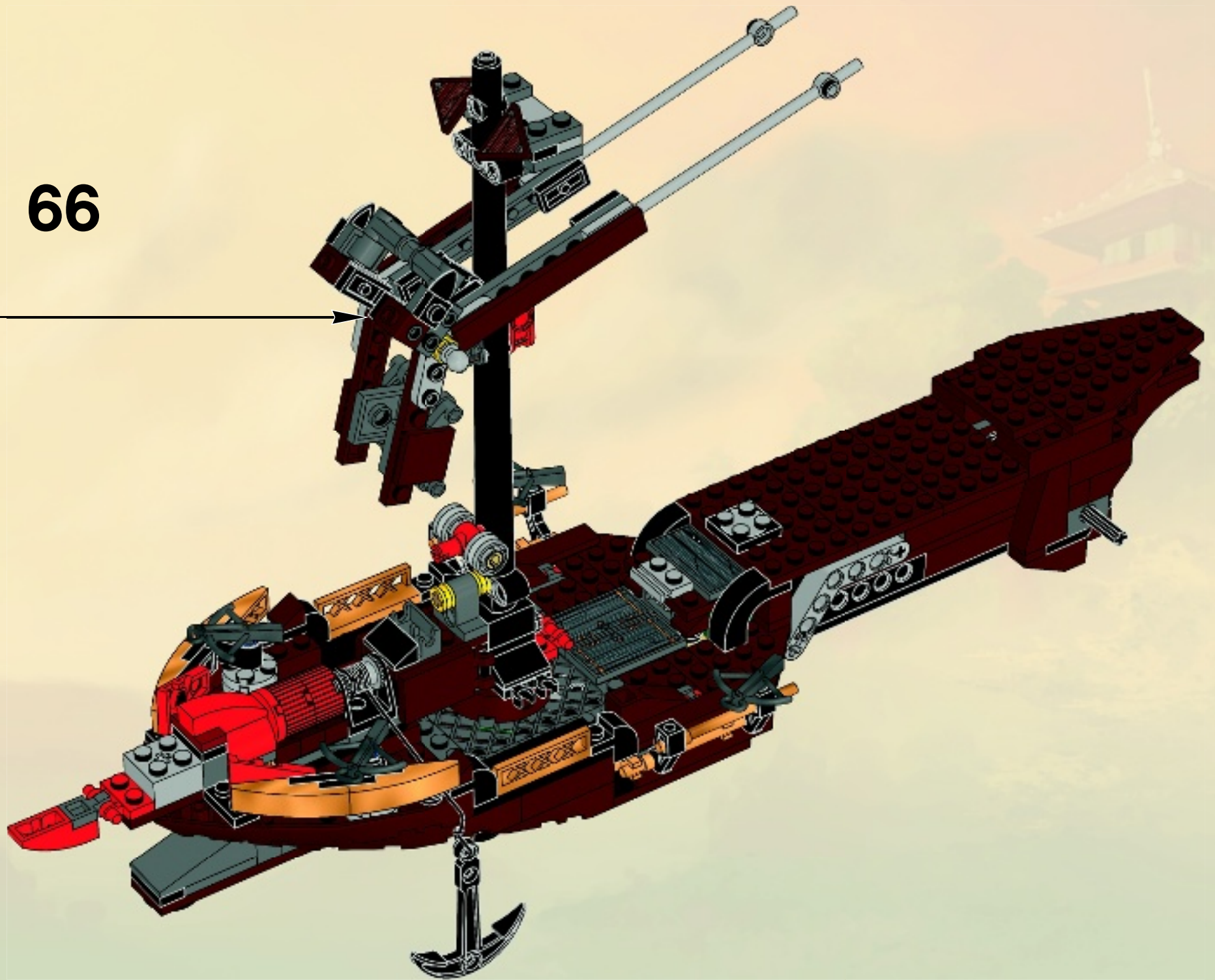

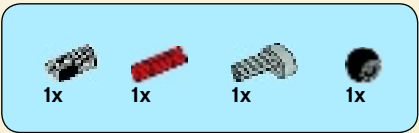

67

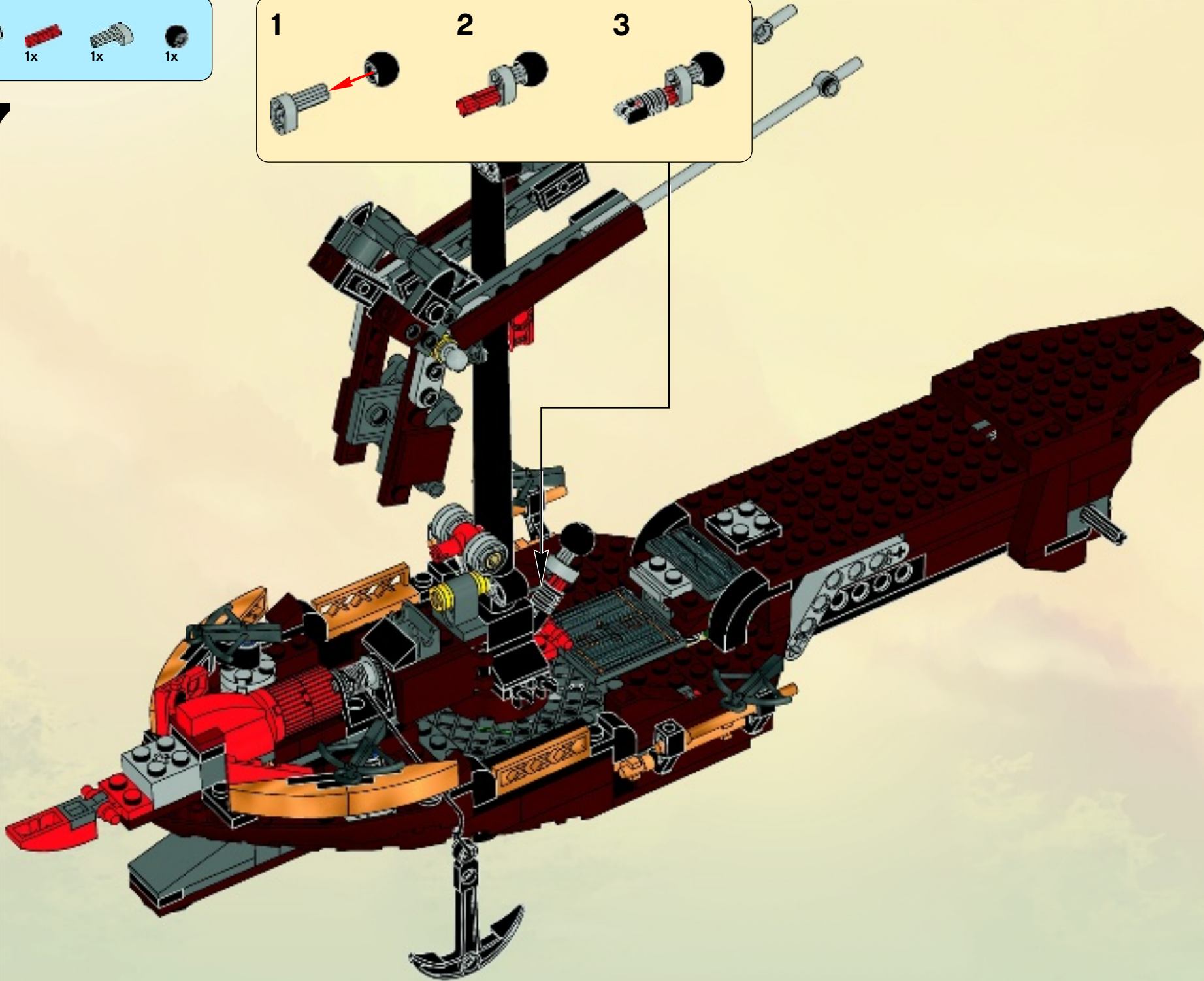
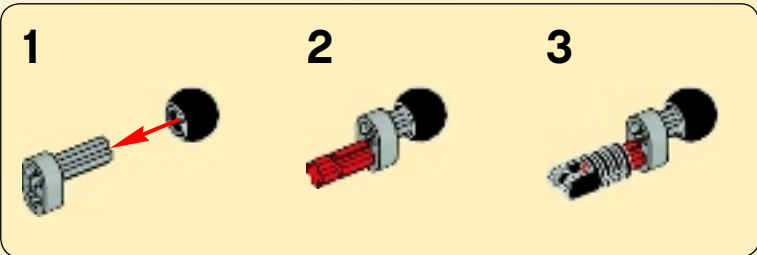





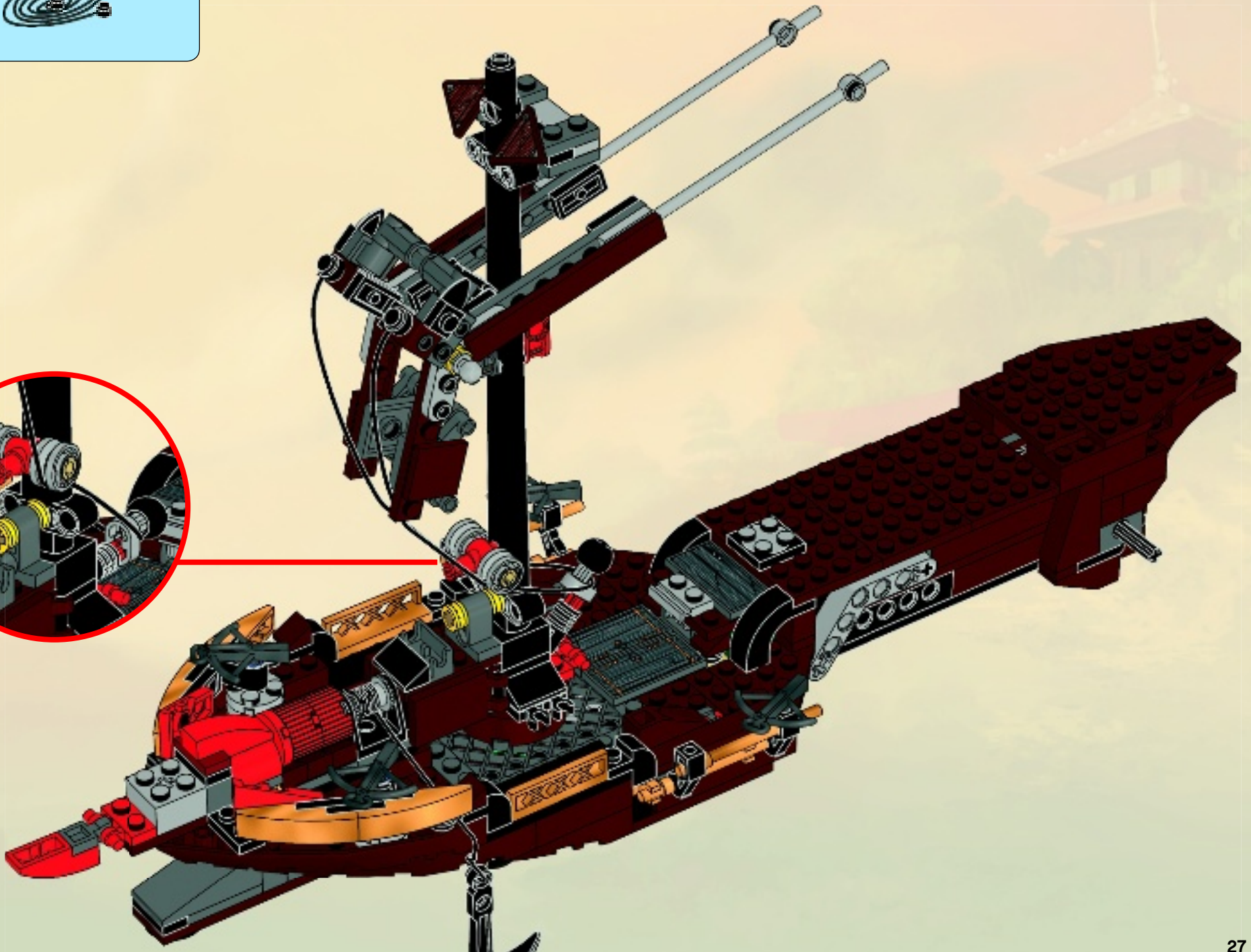
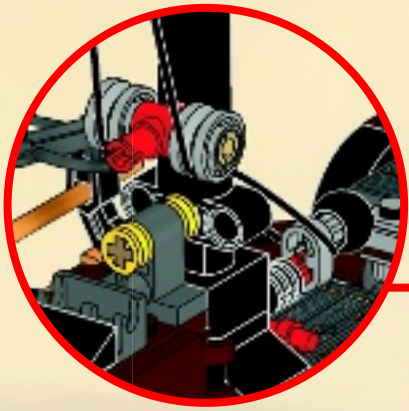

68

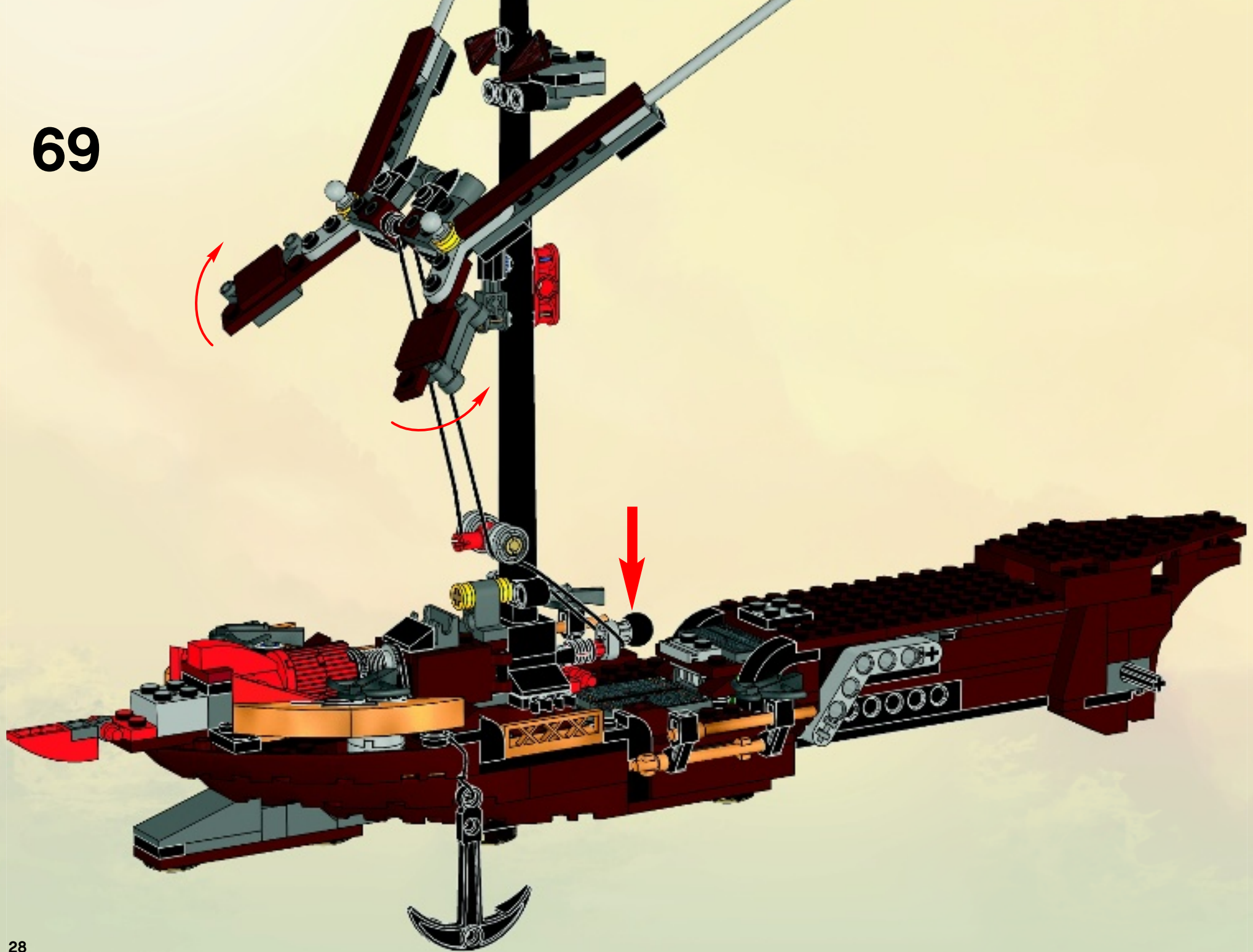

69



1x  2x  1x 

70

1  2  3 

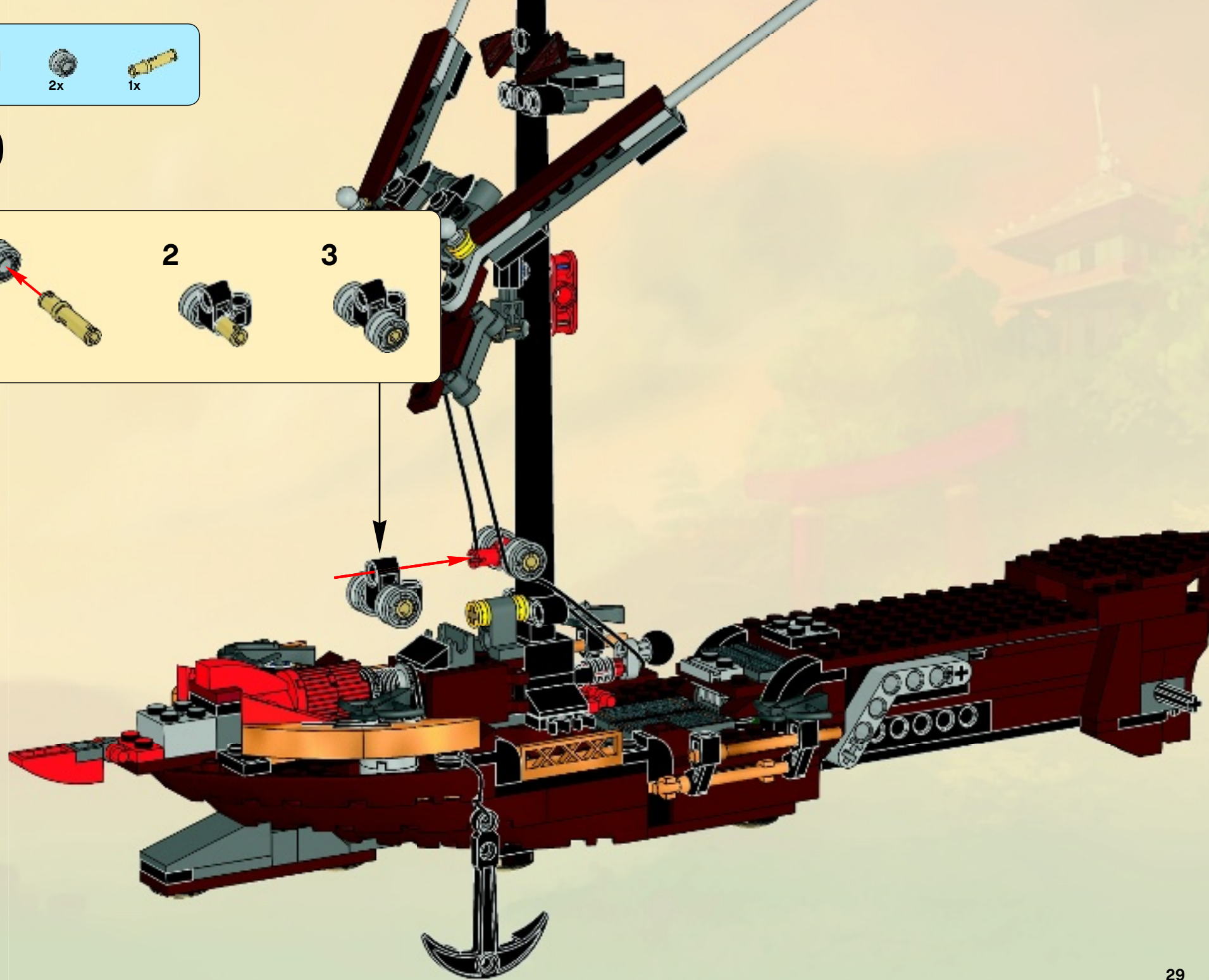

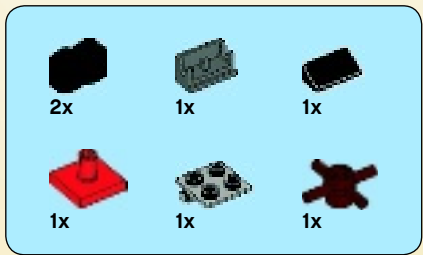

71

1



2

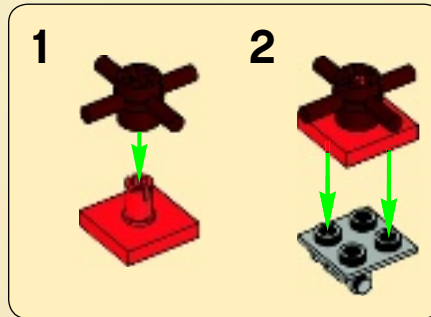

3



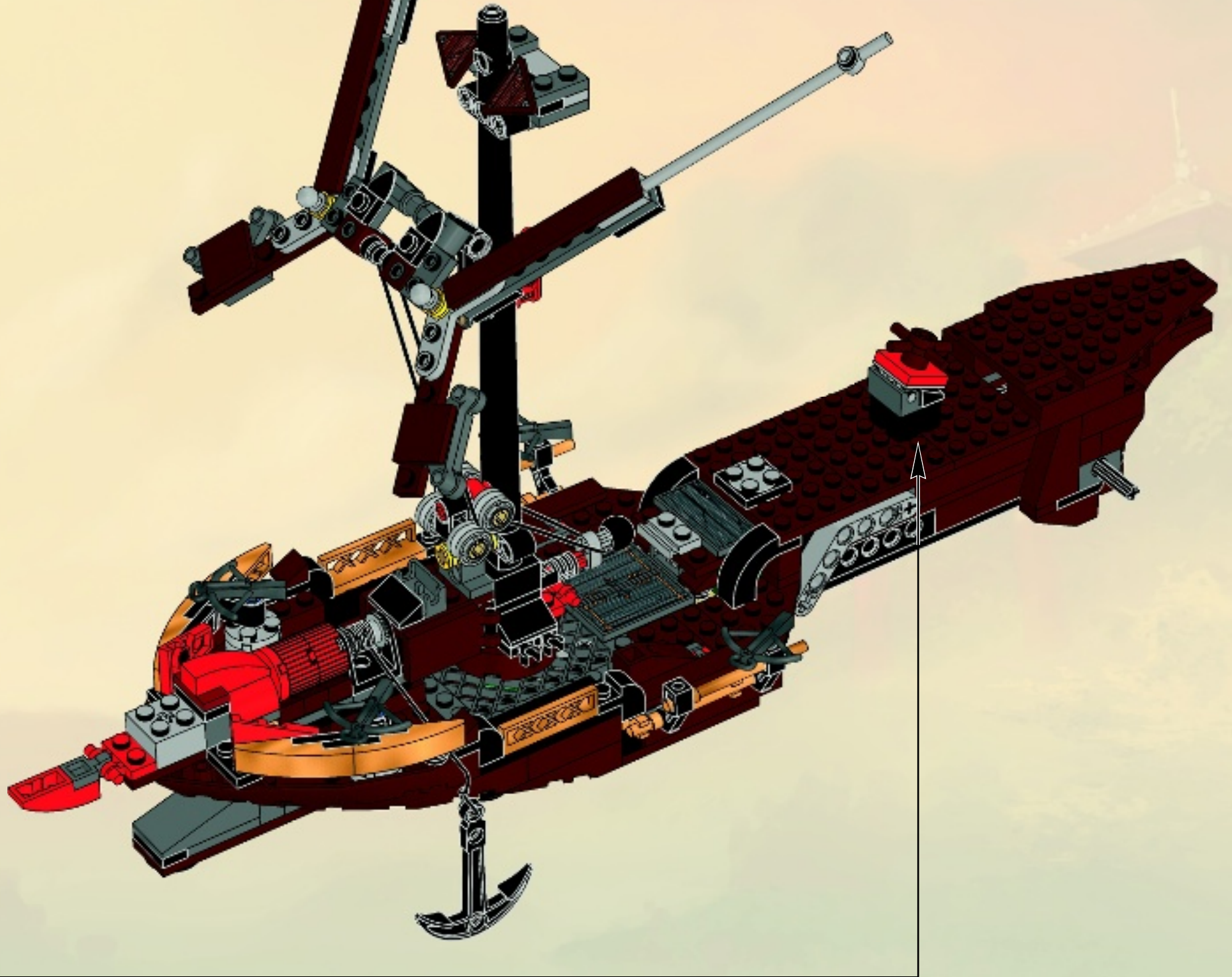

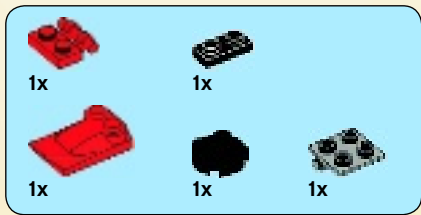

72

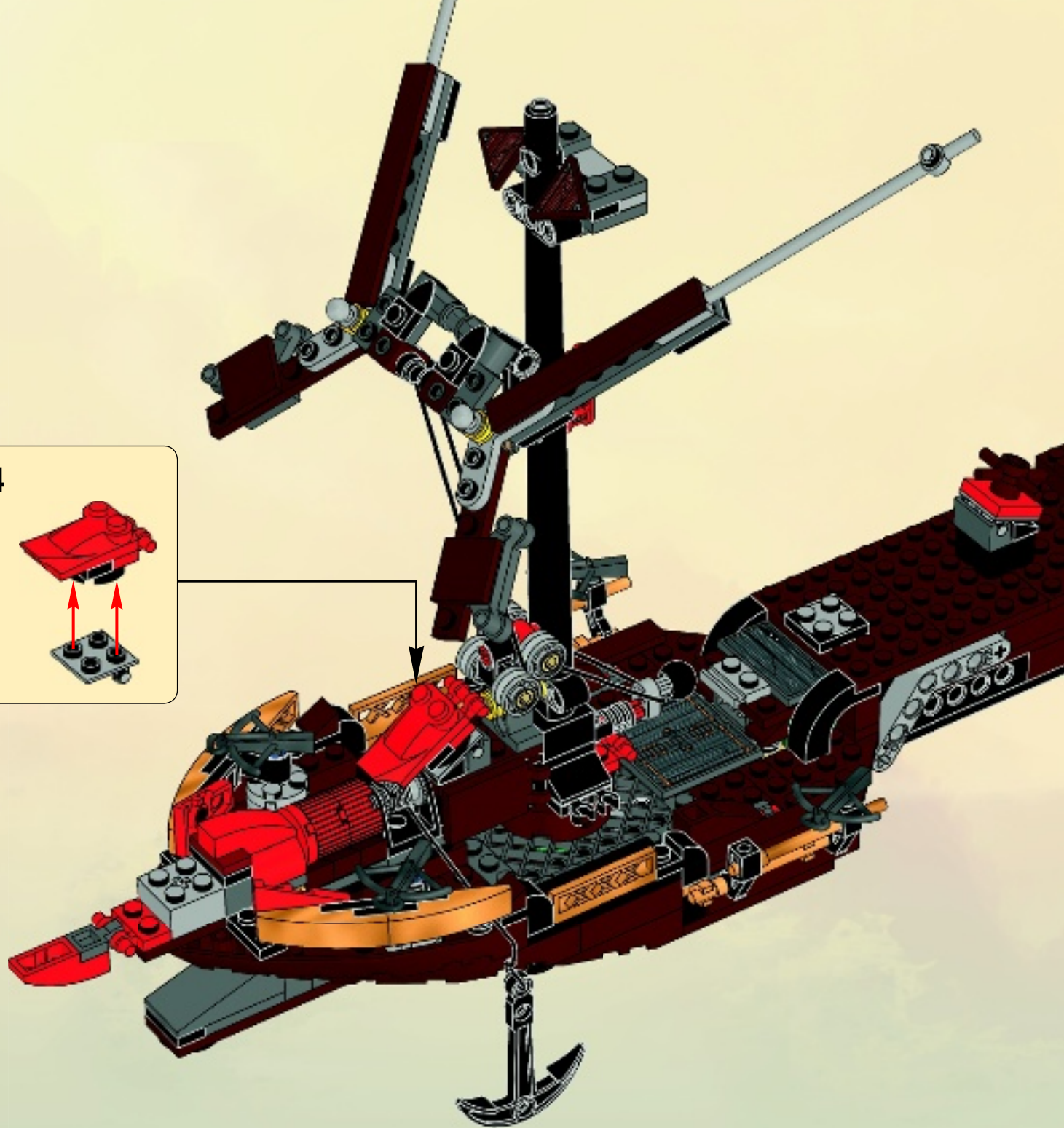
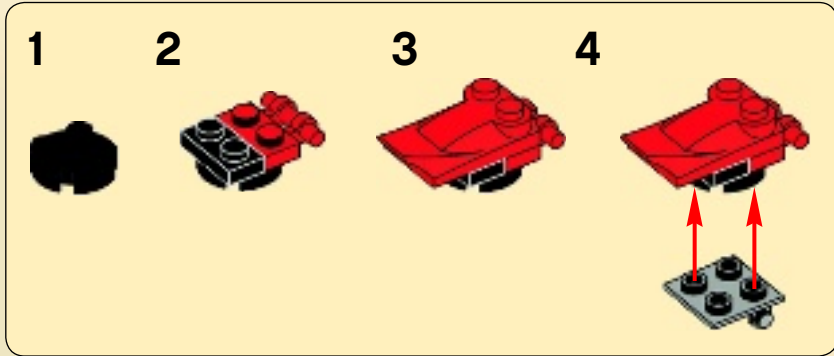

1x  1x 

73

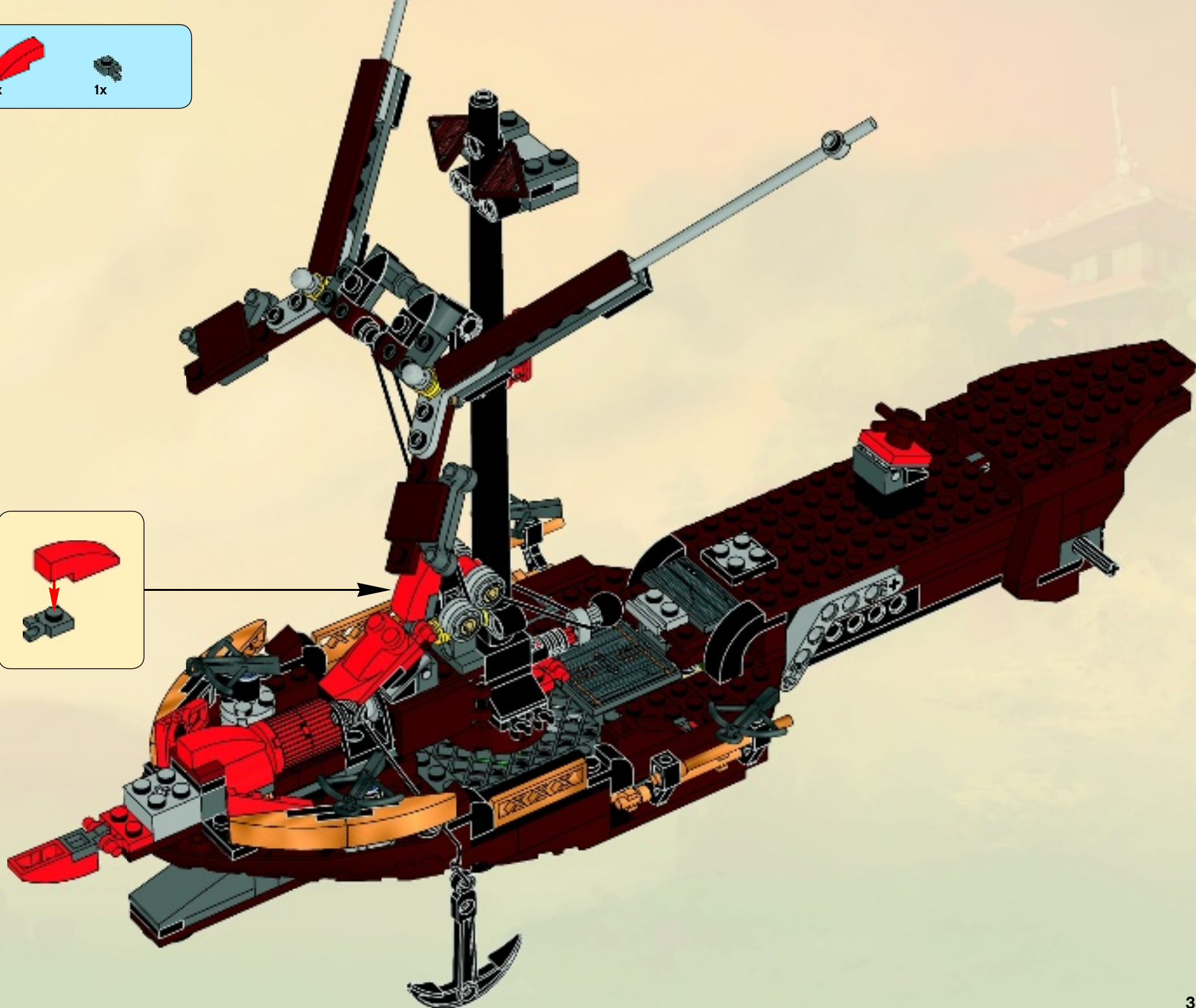
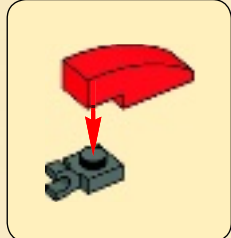

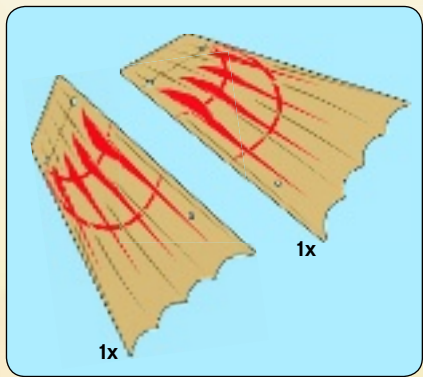

74





4x

75



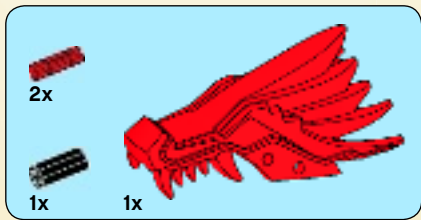

76

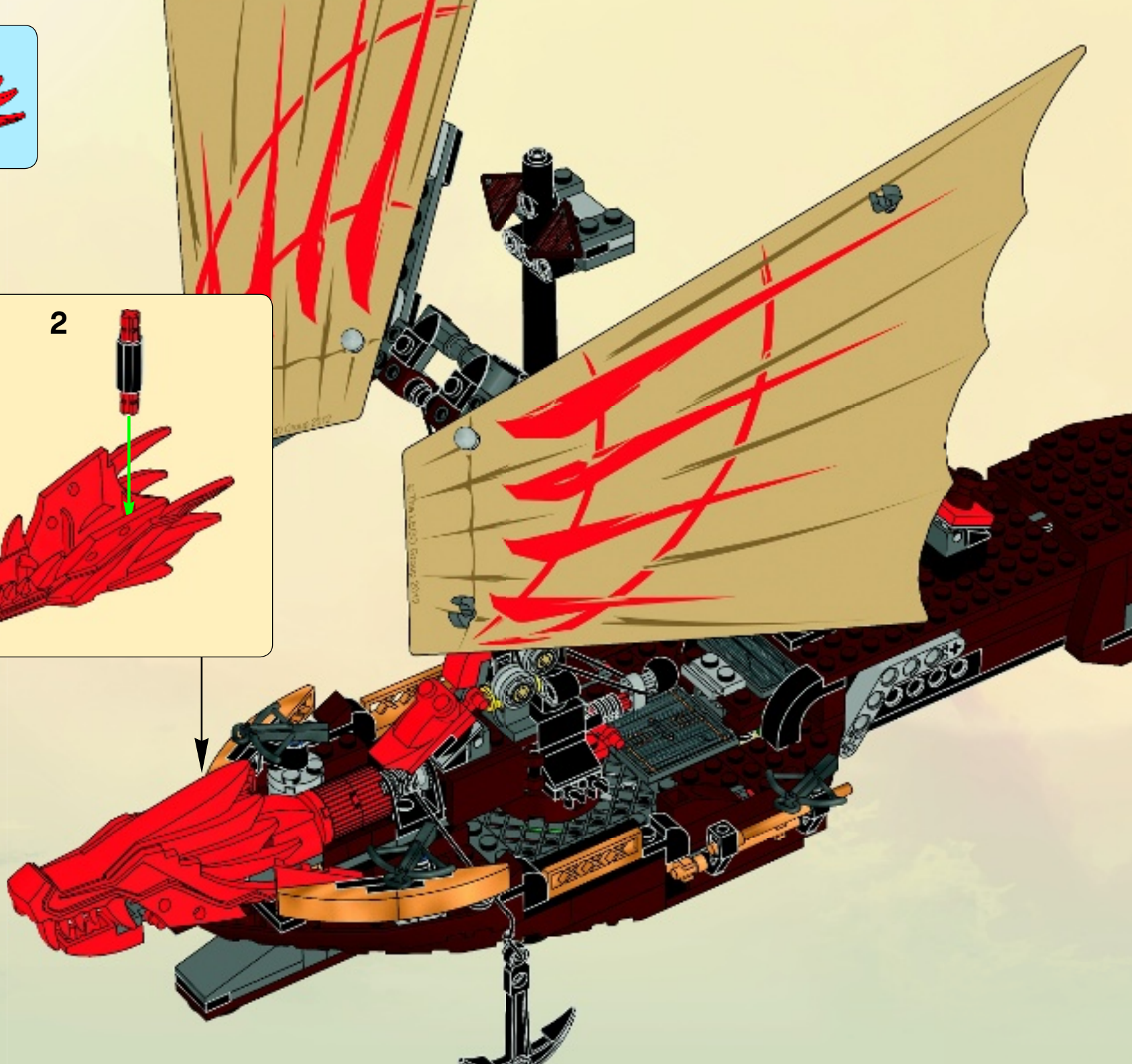
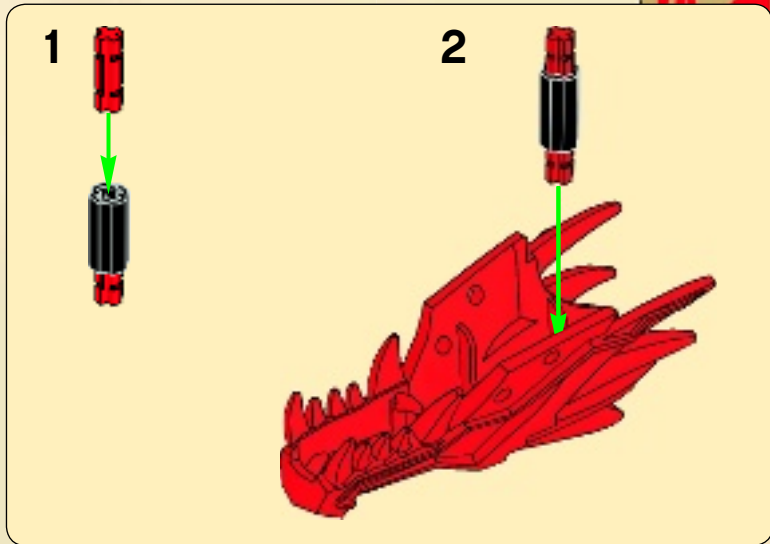

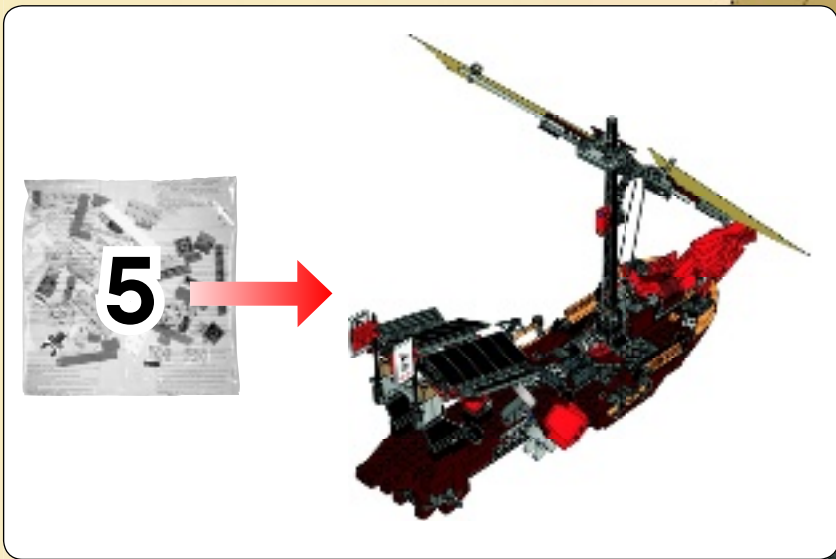

77



8x 2x 2x

78

1 2 3

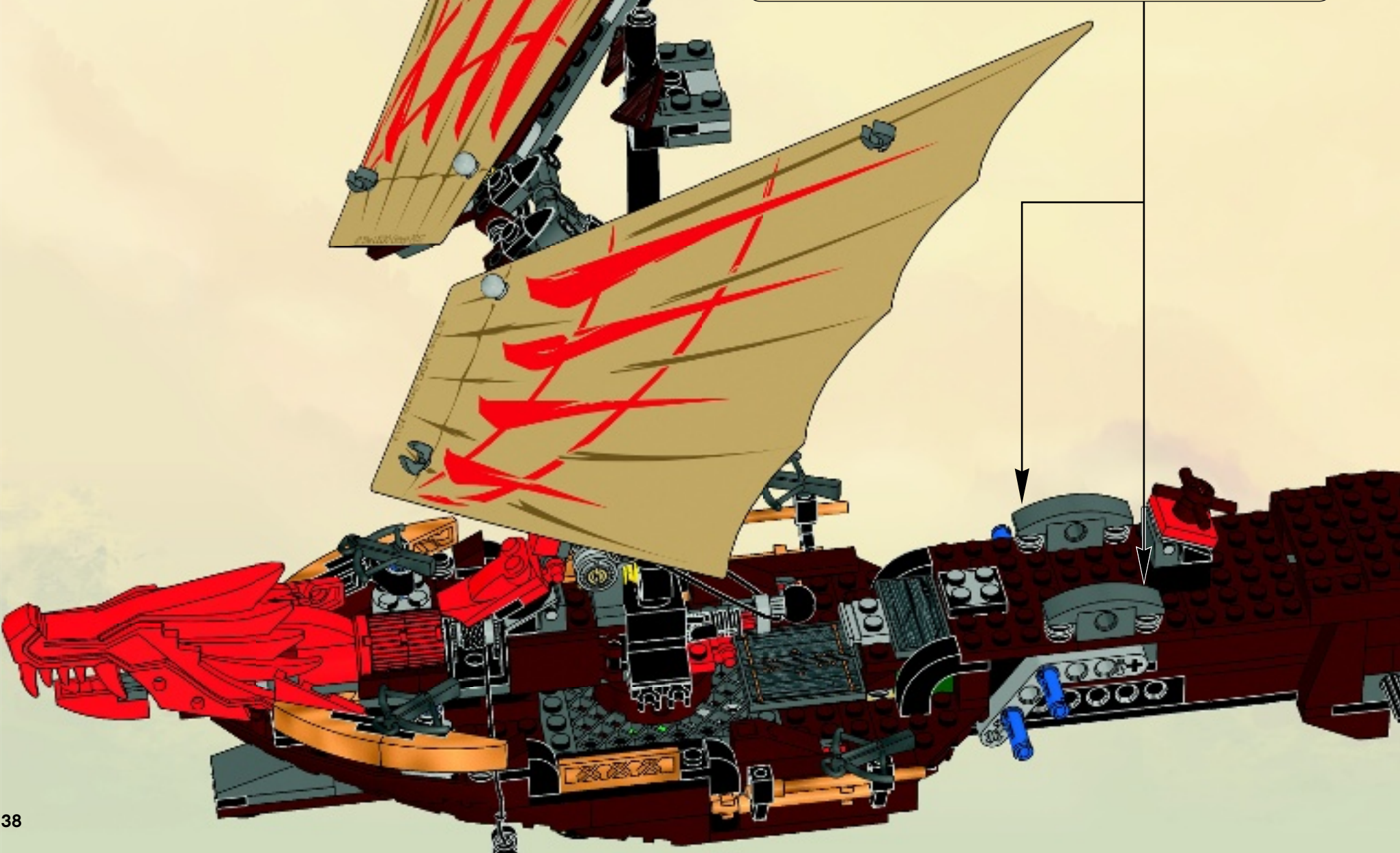

2x





4x

79



4x  2x 

80

  2x

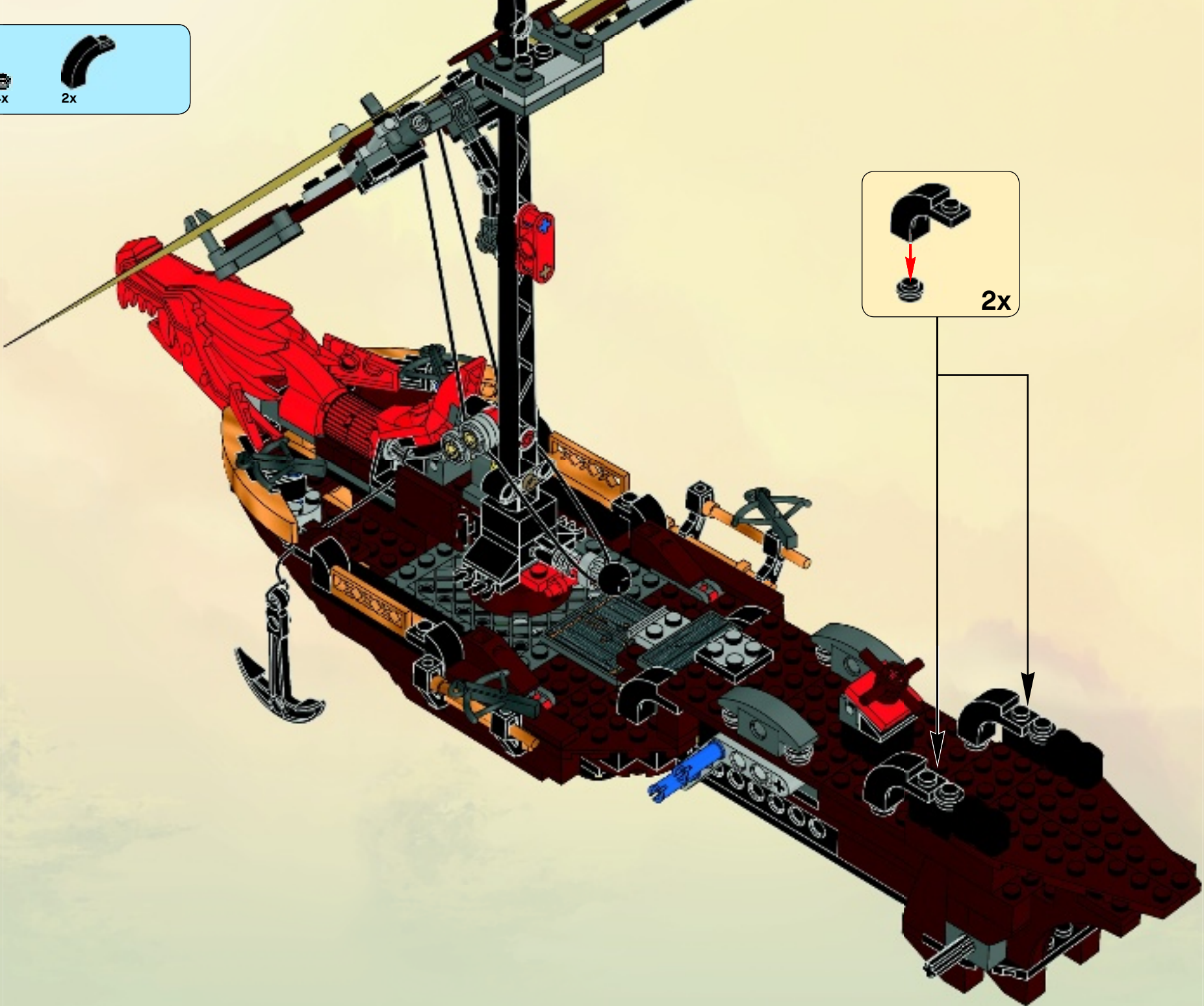

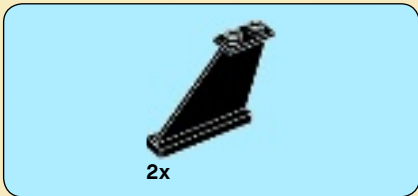

81

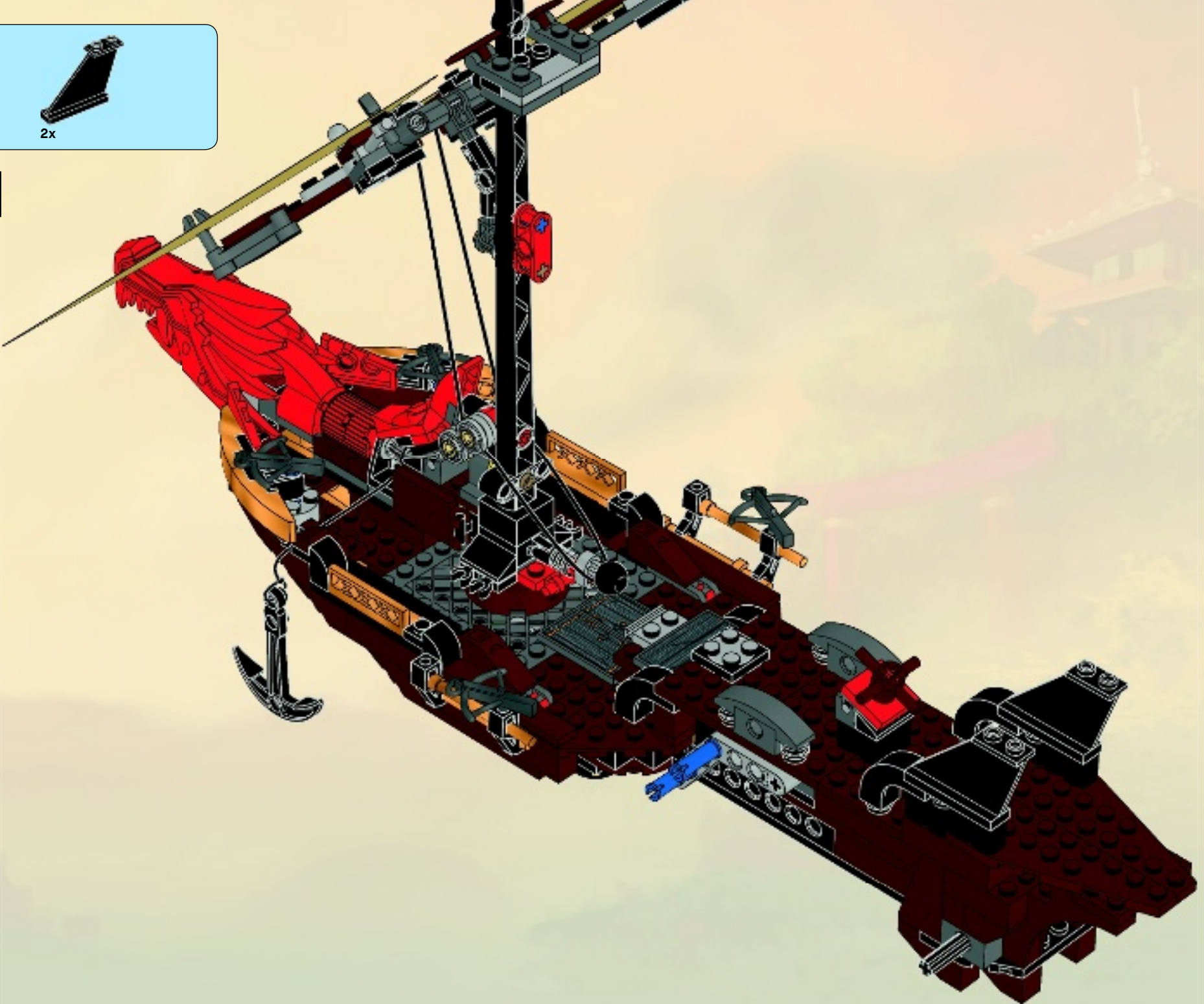

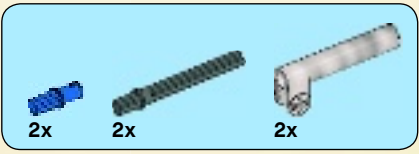

82

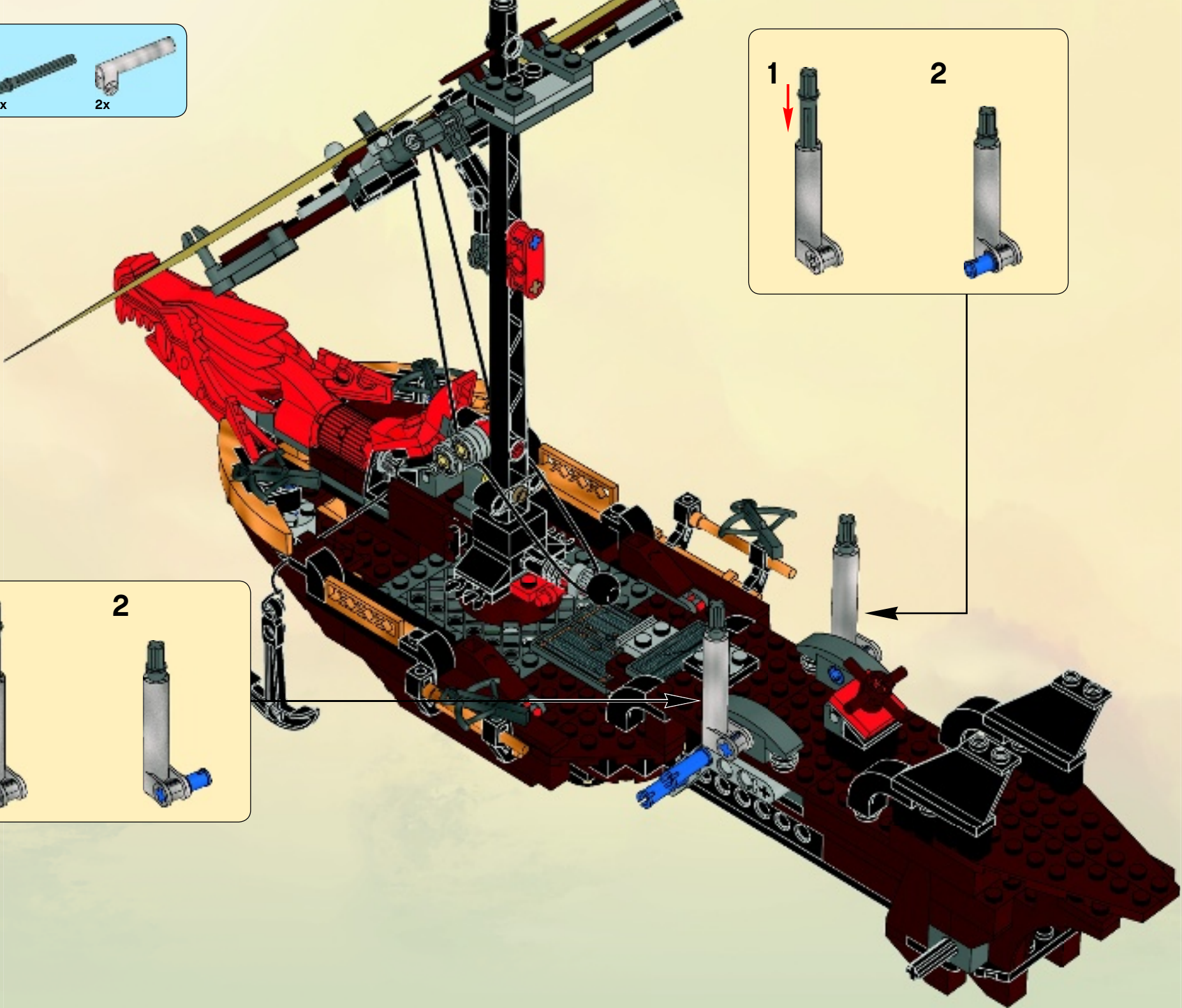
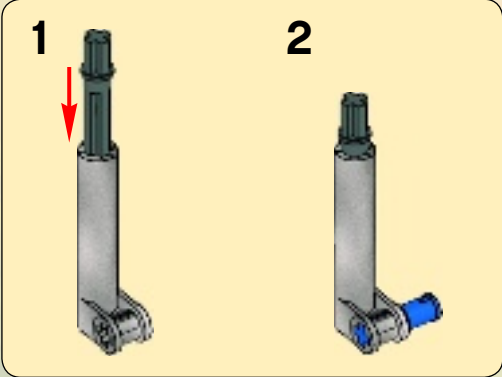
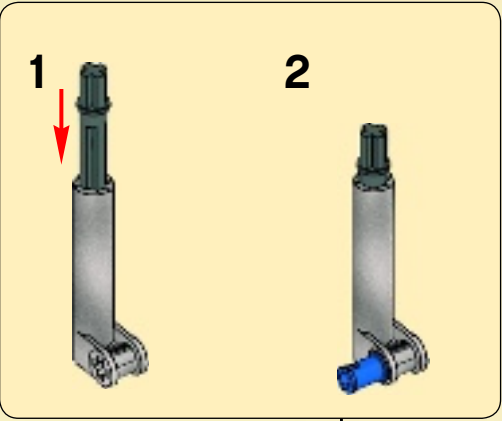



2x

83

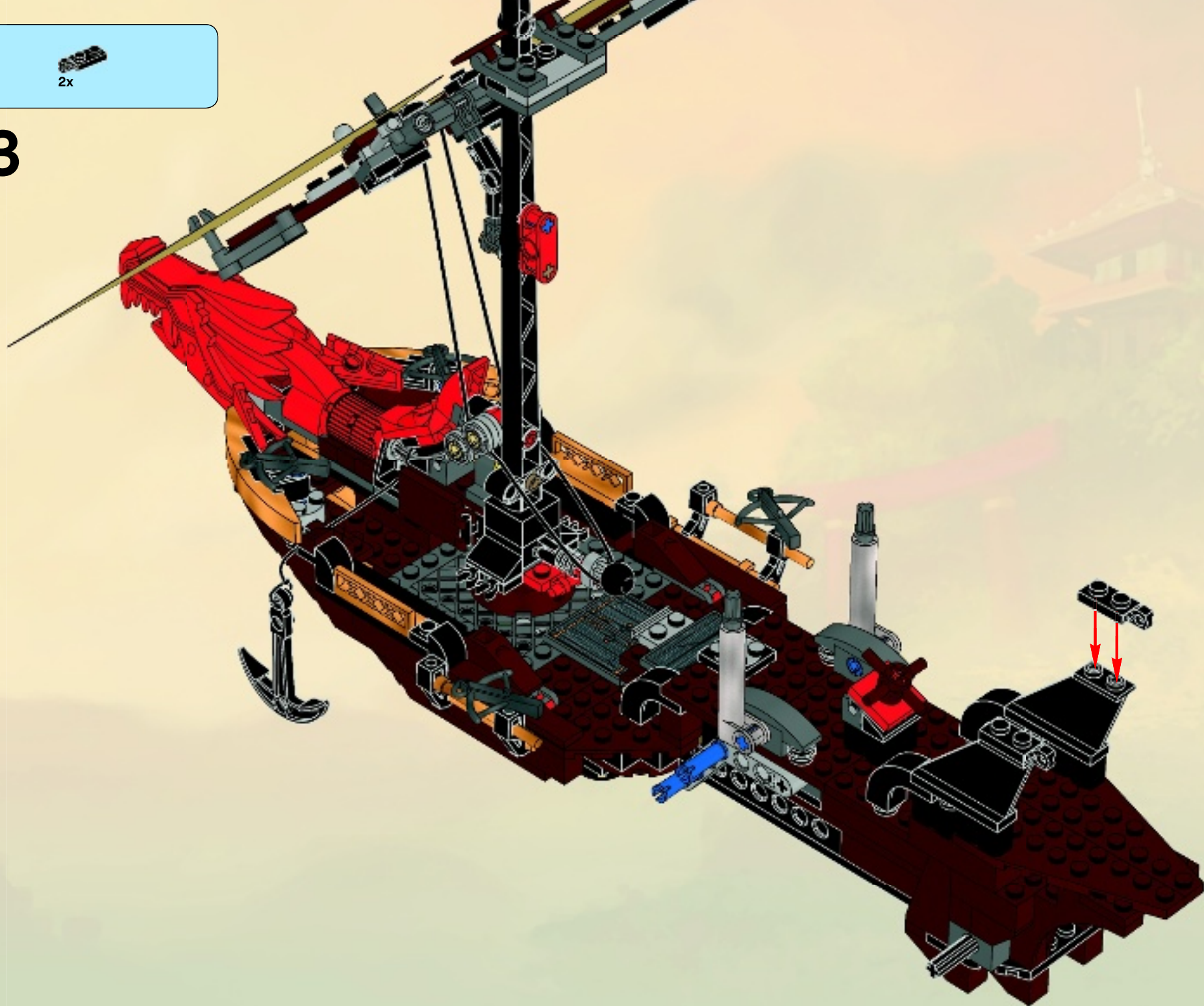

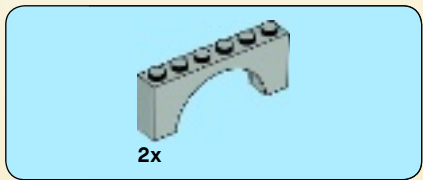

84

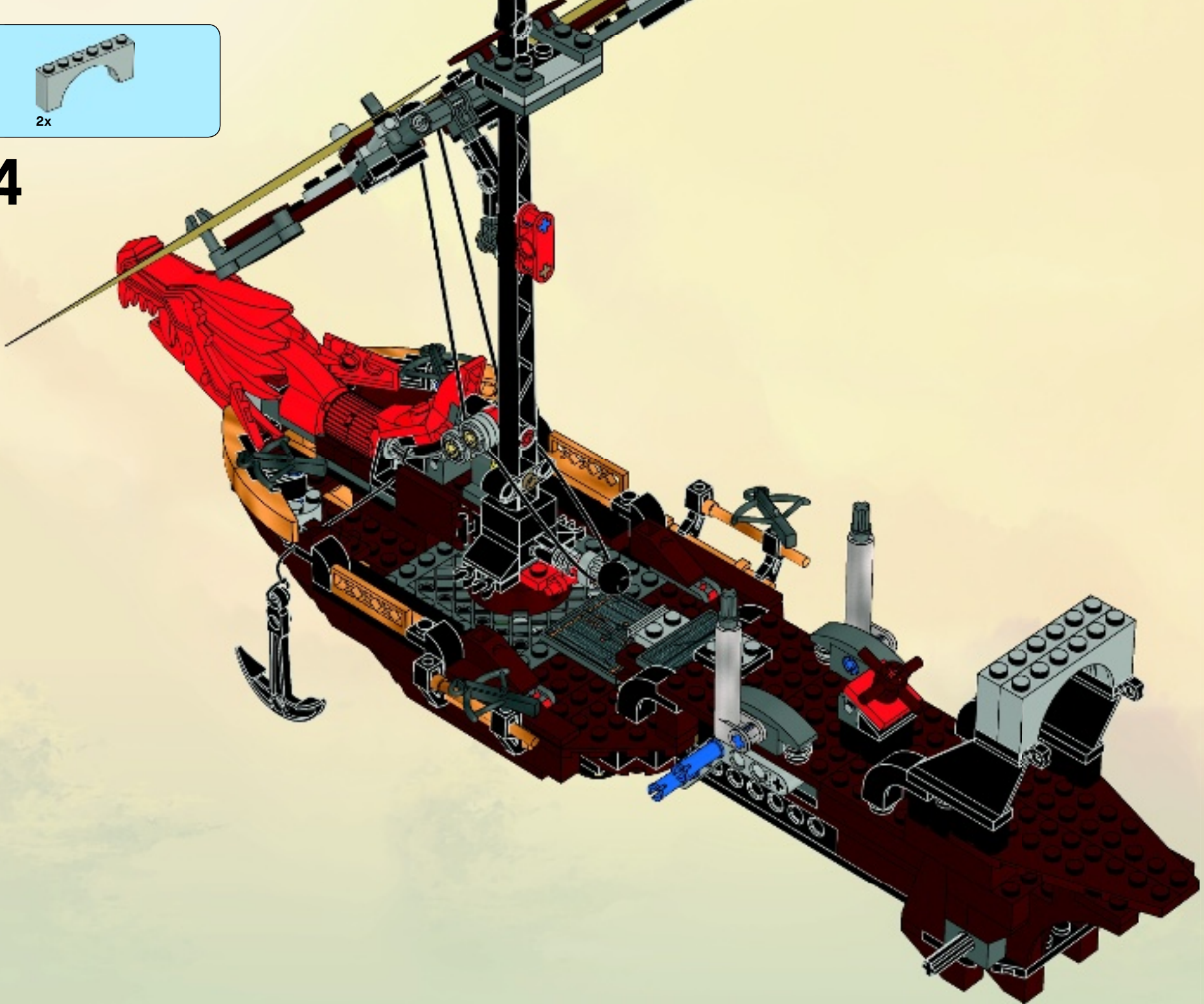

2x  2x 



85



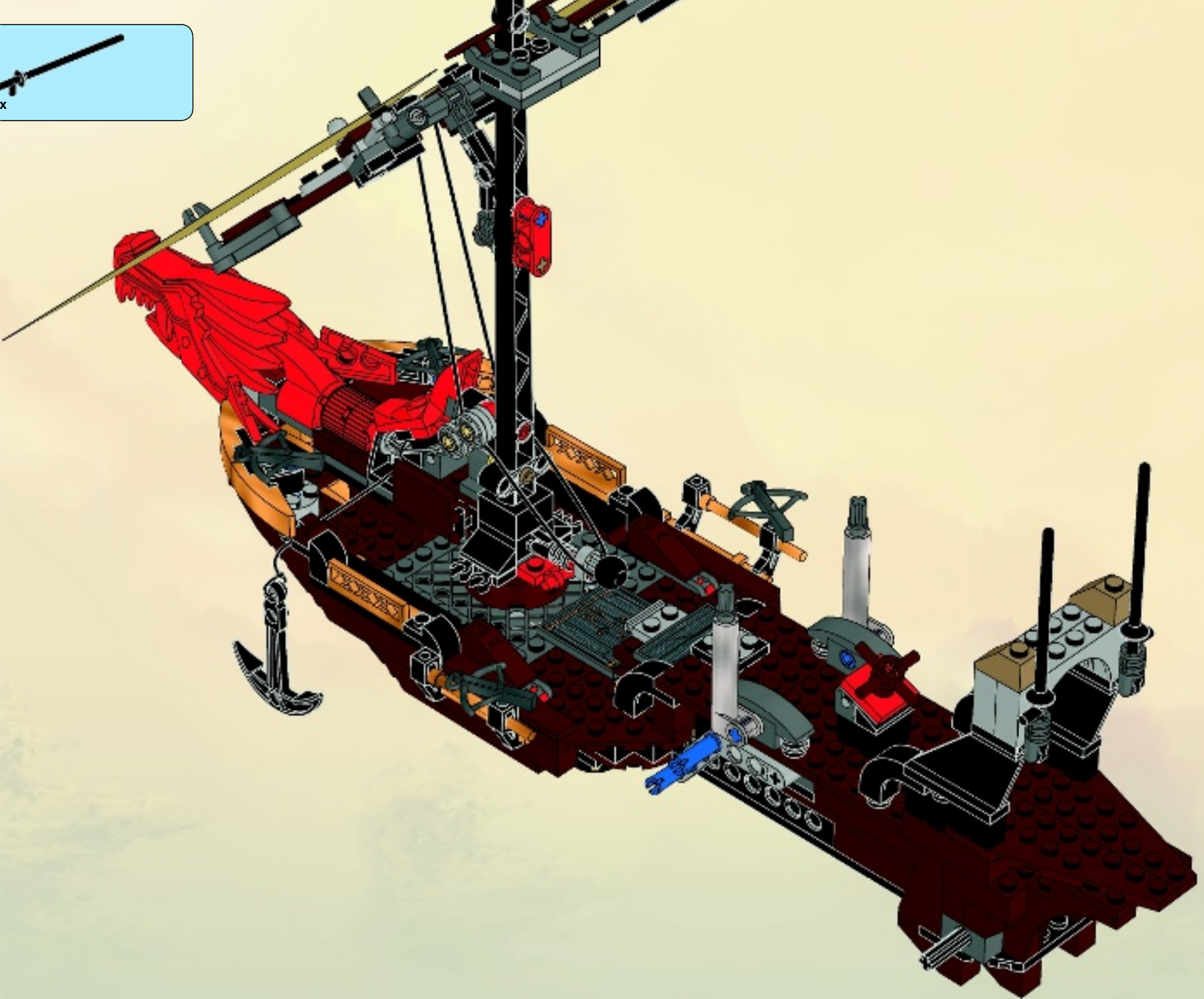

86



4x  2x 

87

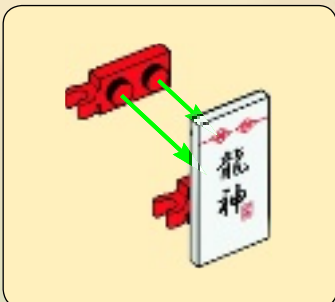
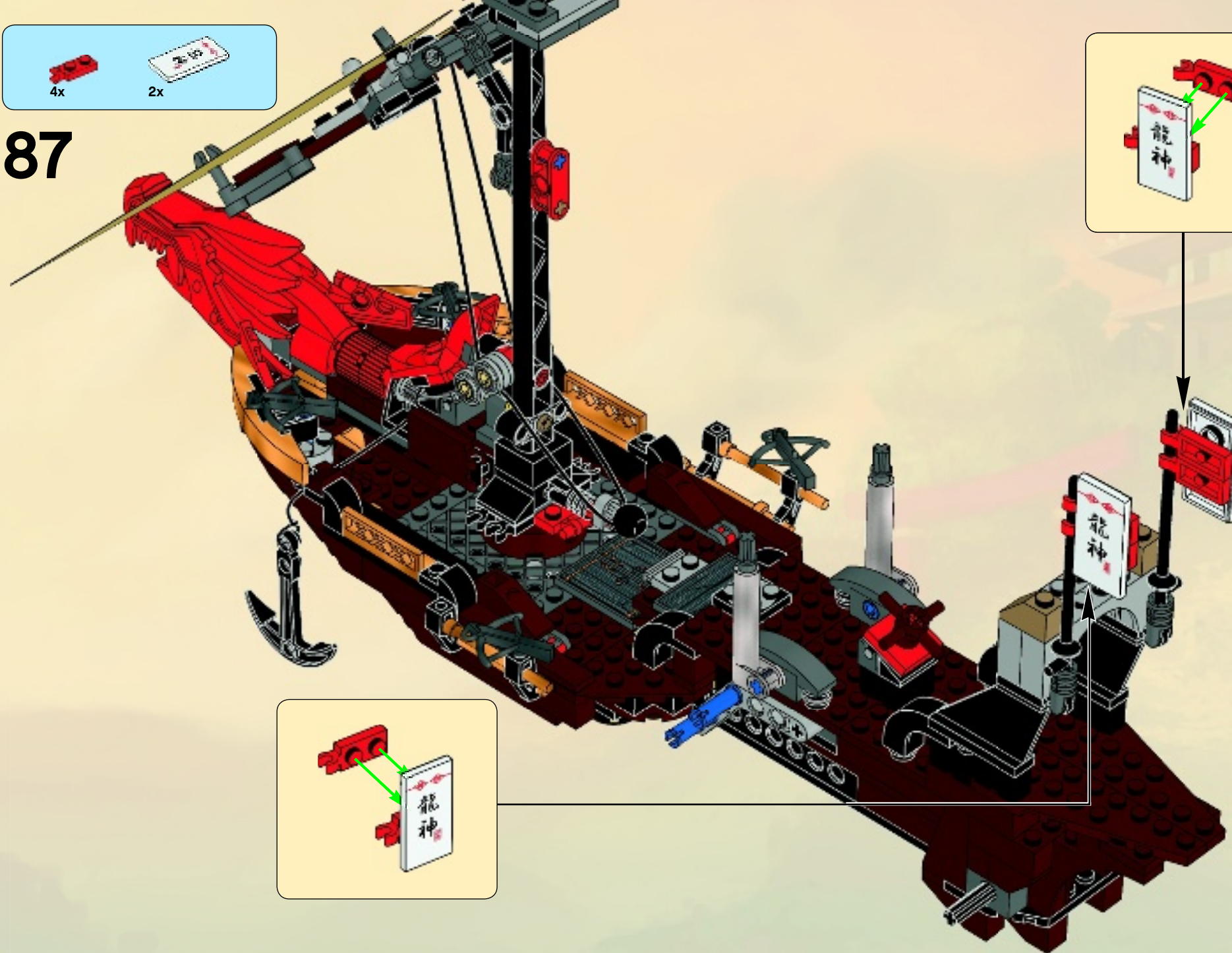
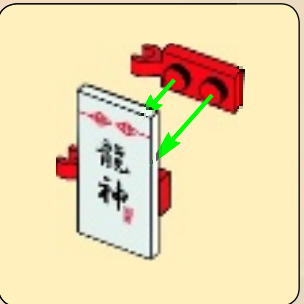

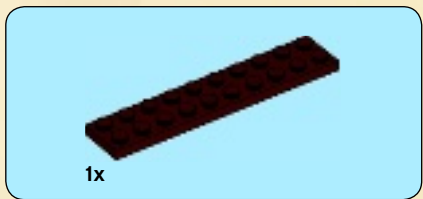

1

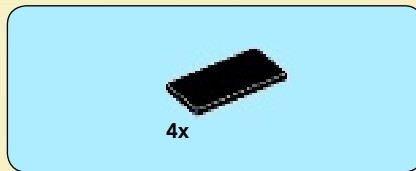

2

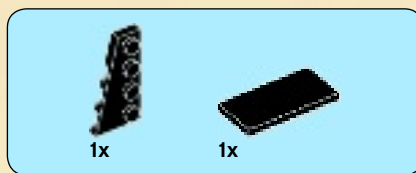
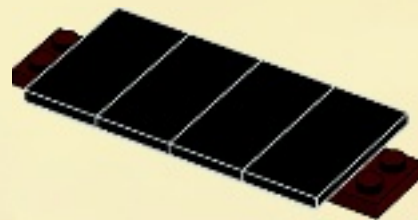

2





3

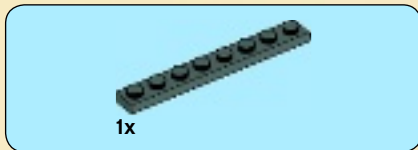
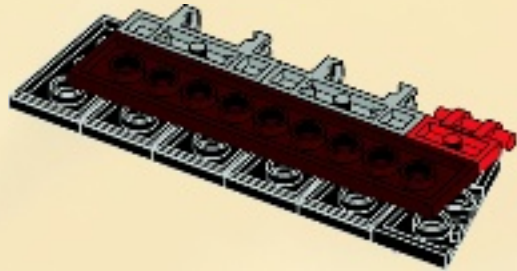
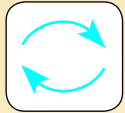

4

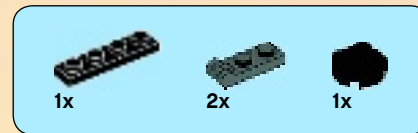
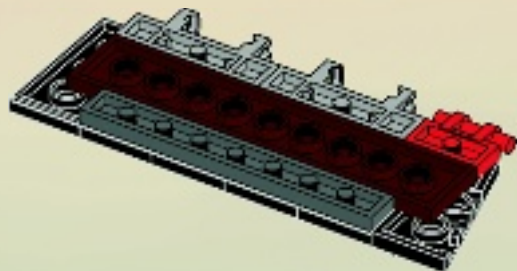

5

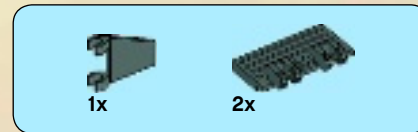
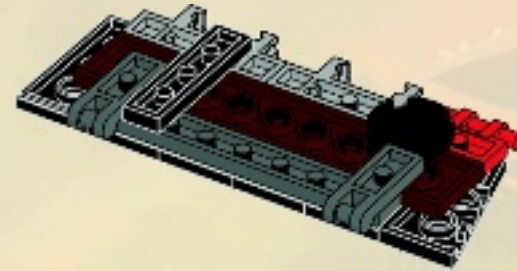

6

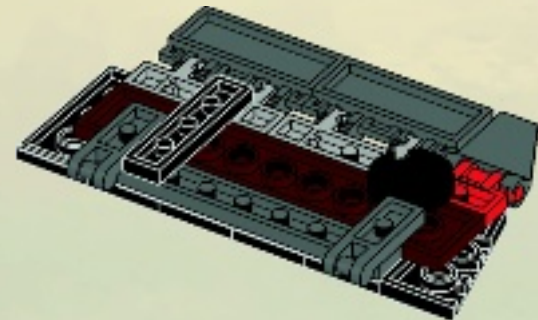

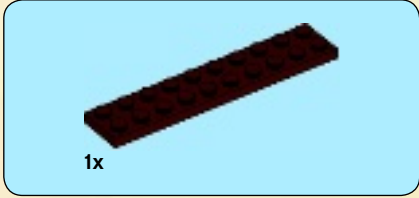
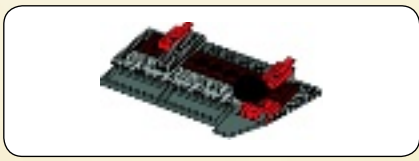

1

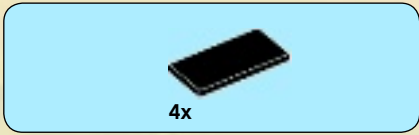

2

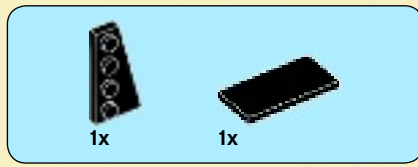
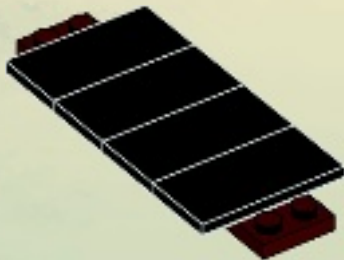

3

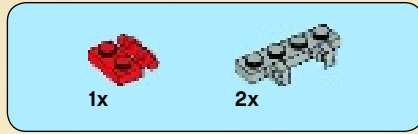

4

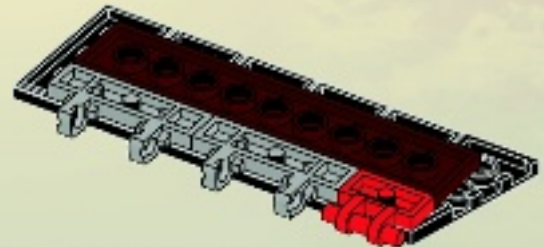
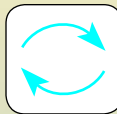

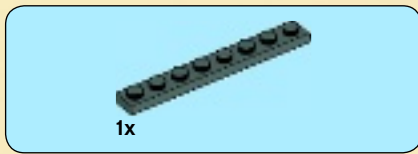

5

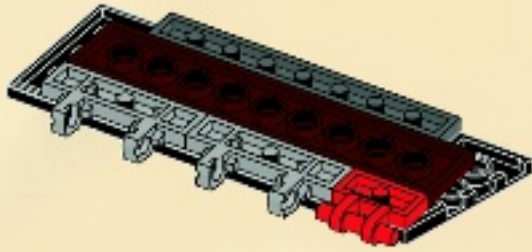

6

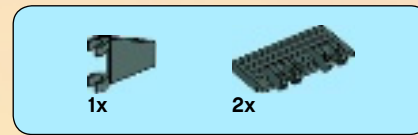
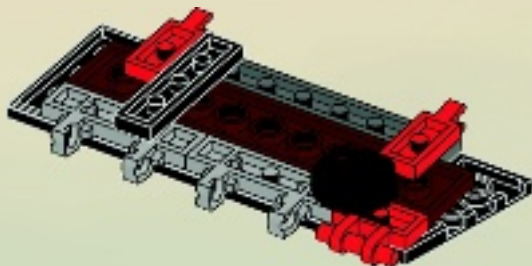

7

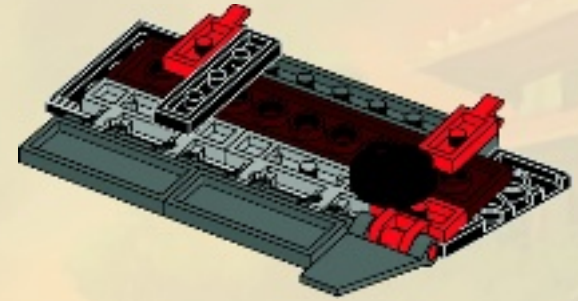

8

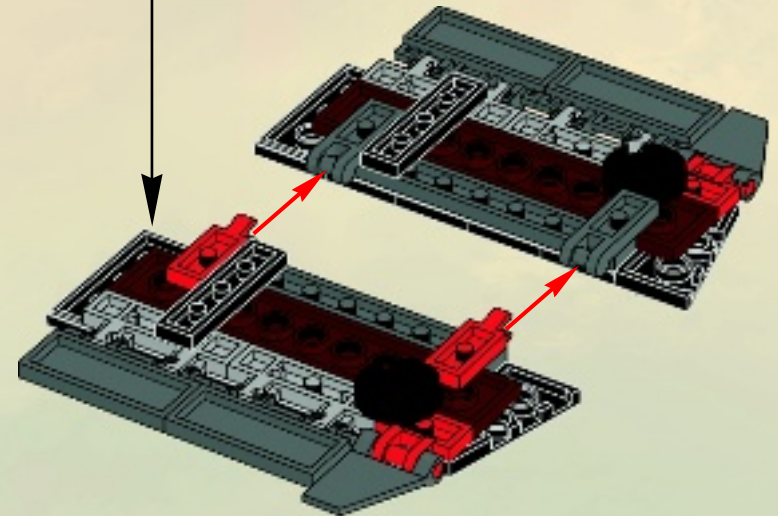



9

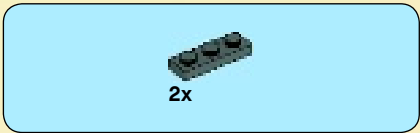
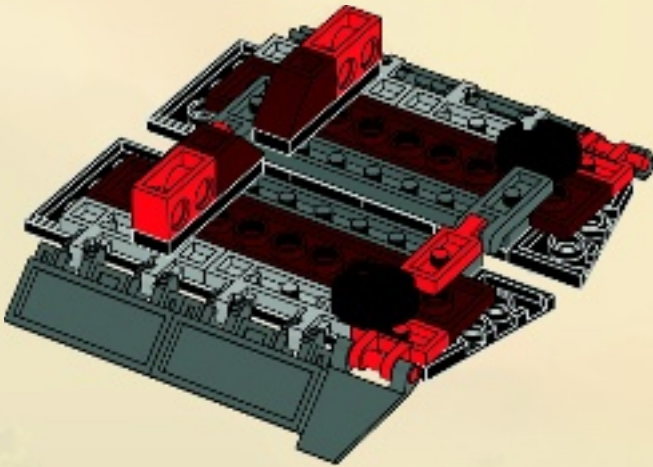

10

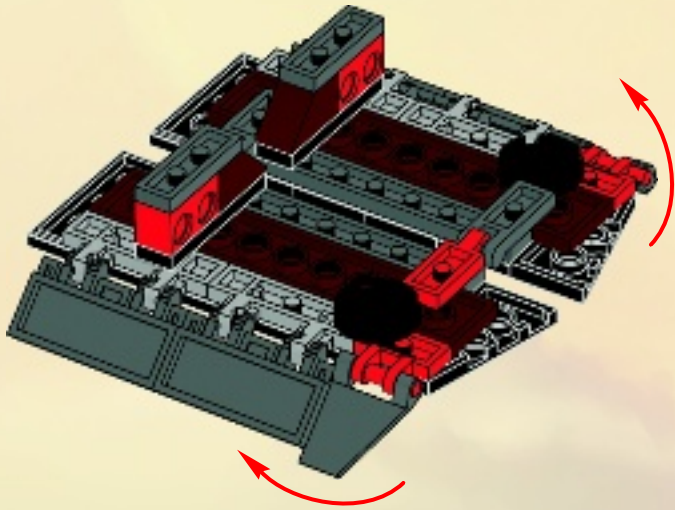

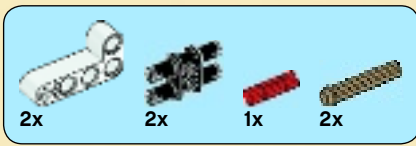

11

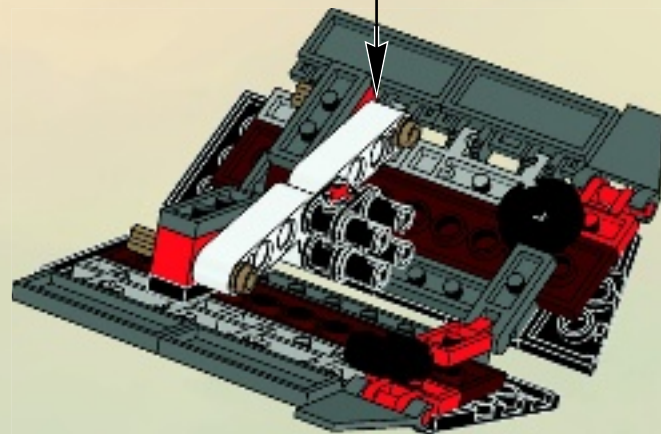
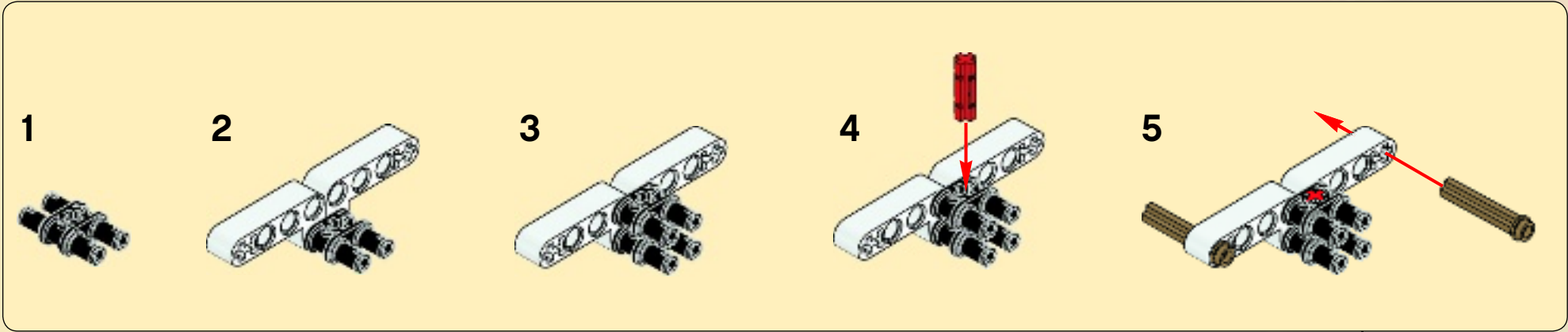



2x

12

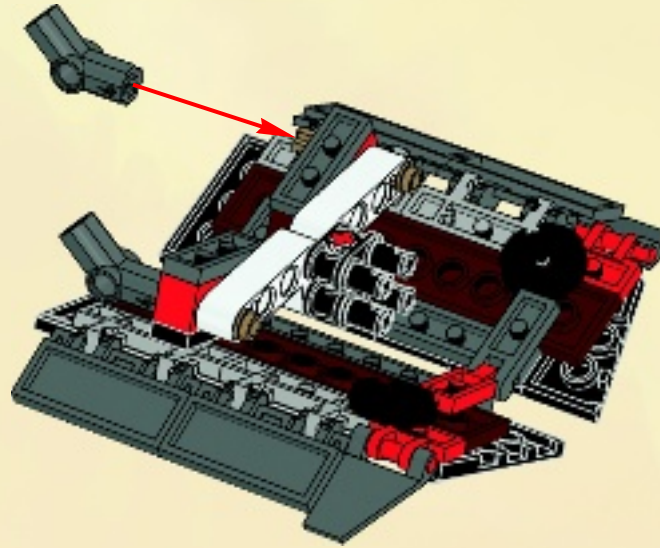

13

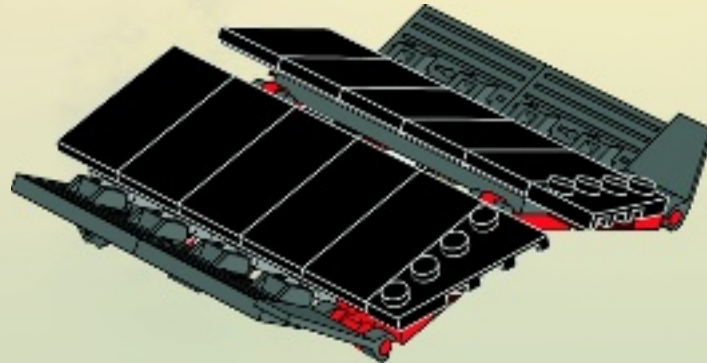
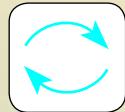

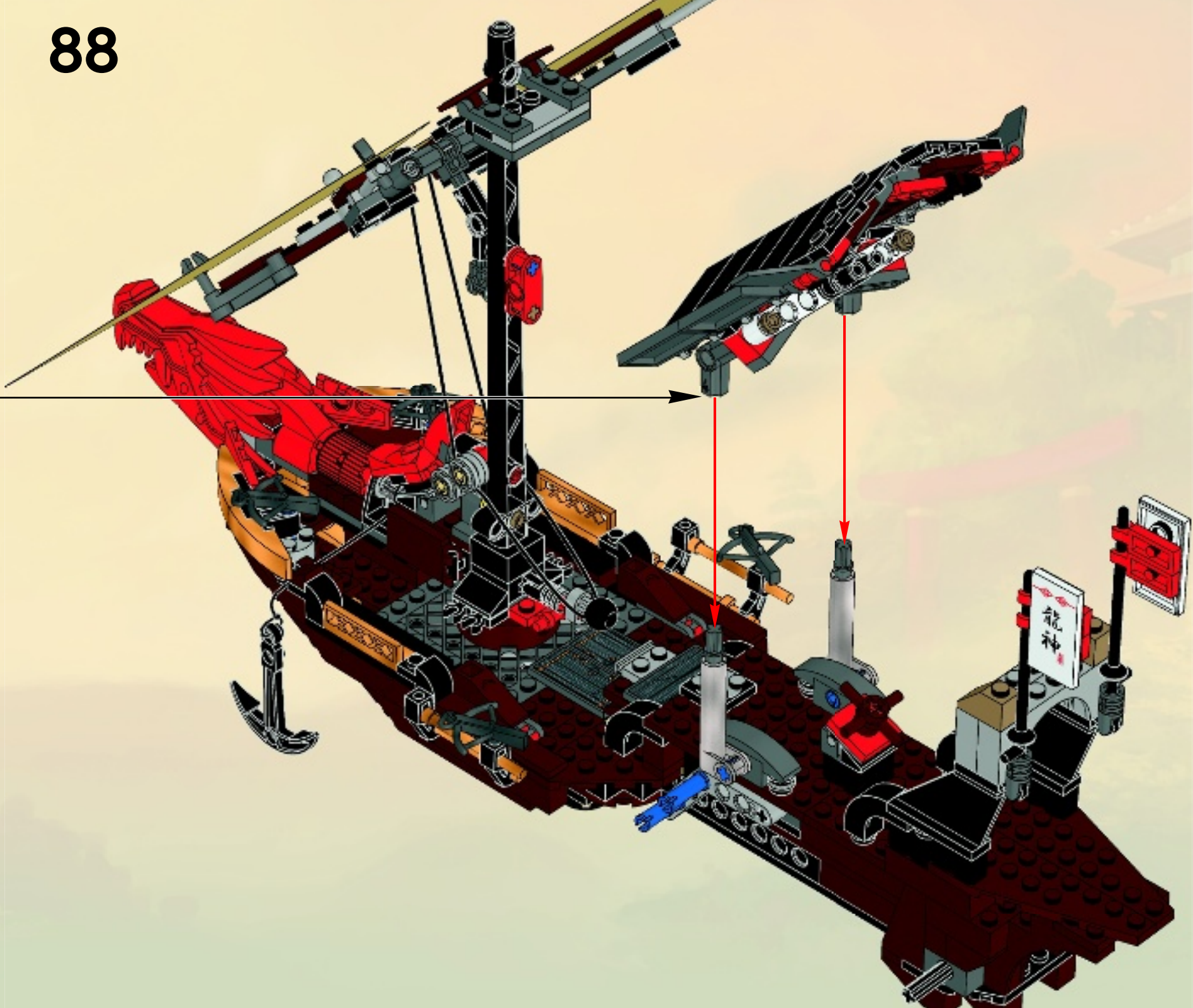

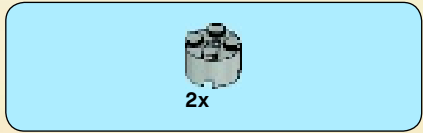
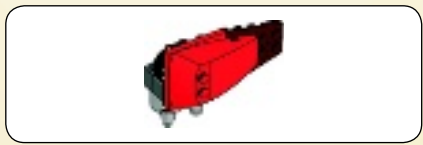

1

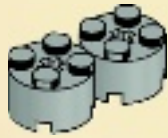

2

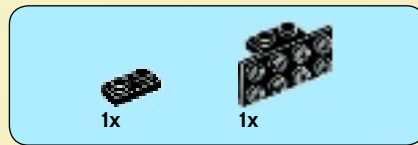

3



4



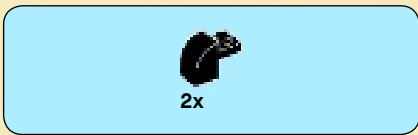

5



6

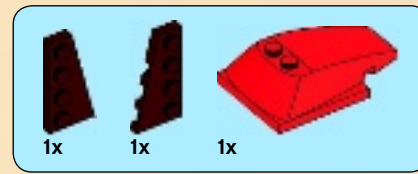
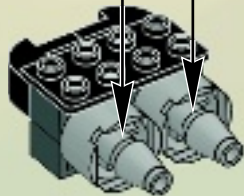
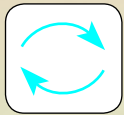
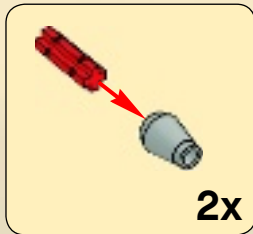

7

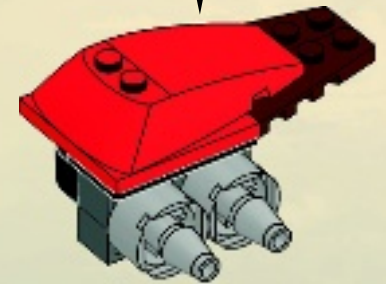
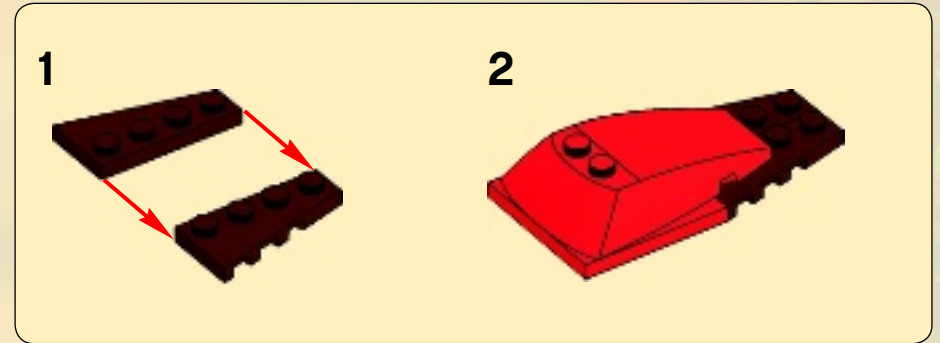

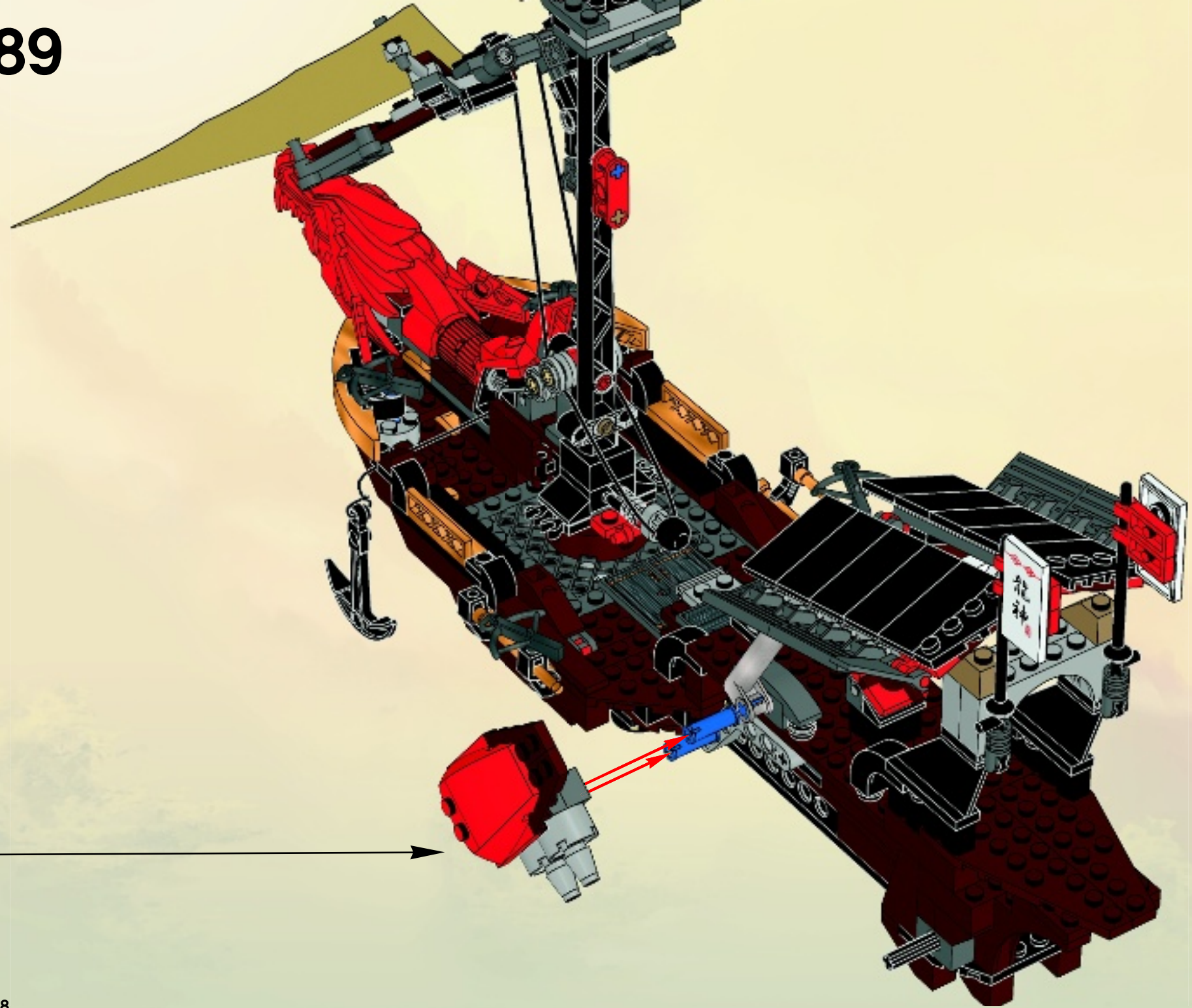

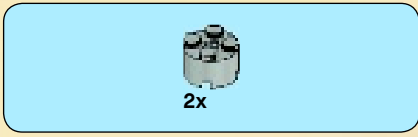
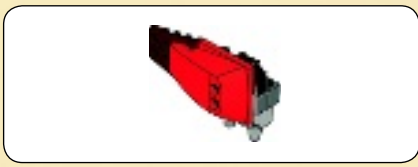

1



2

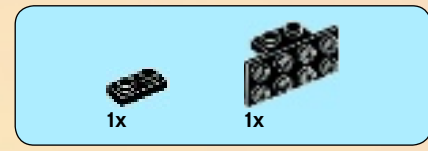
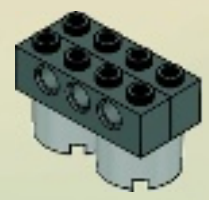

3

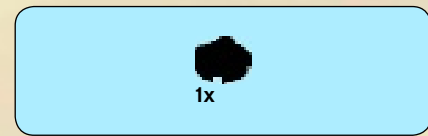

4

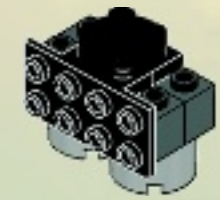



2x

5

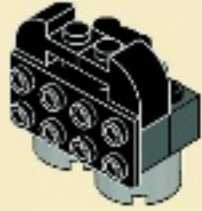

2x



2x

6

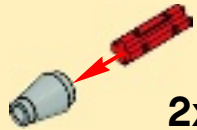

2x

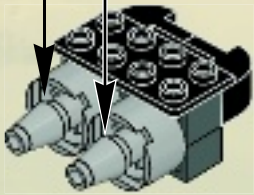

1x



1x

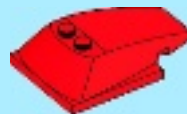

1x

7

1

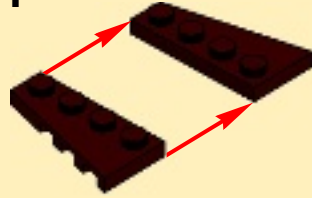

2

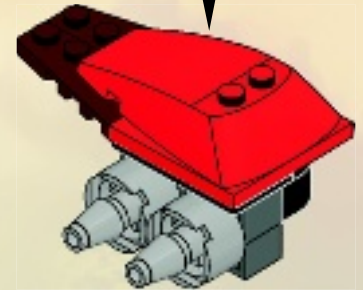
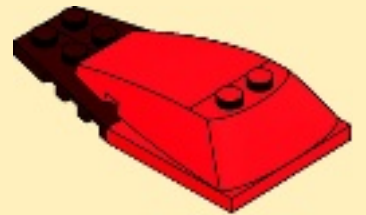

90

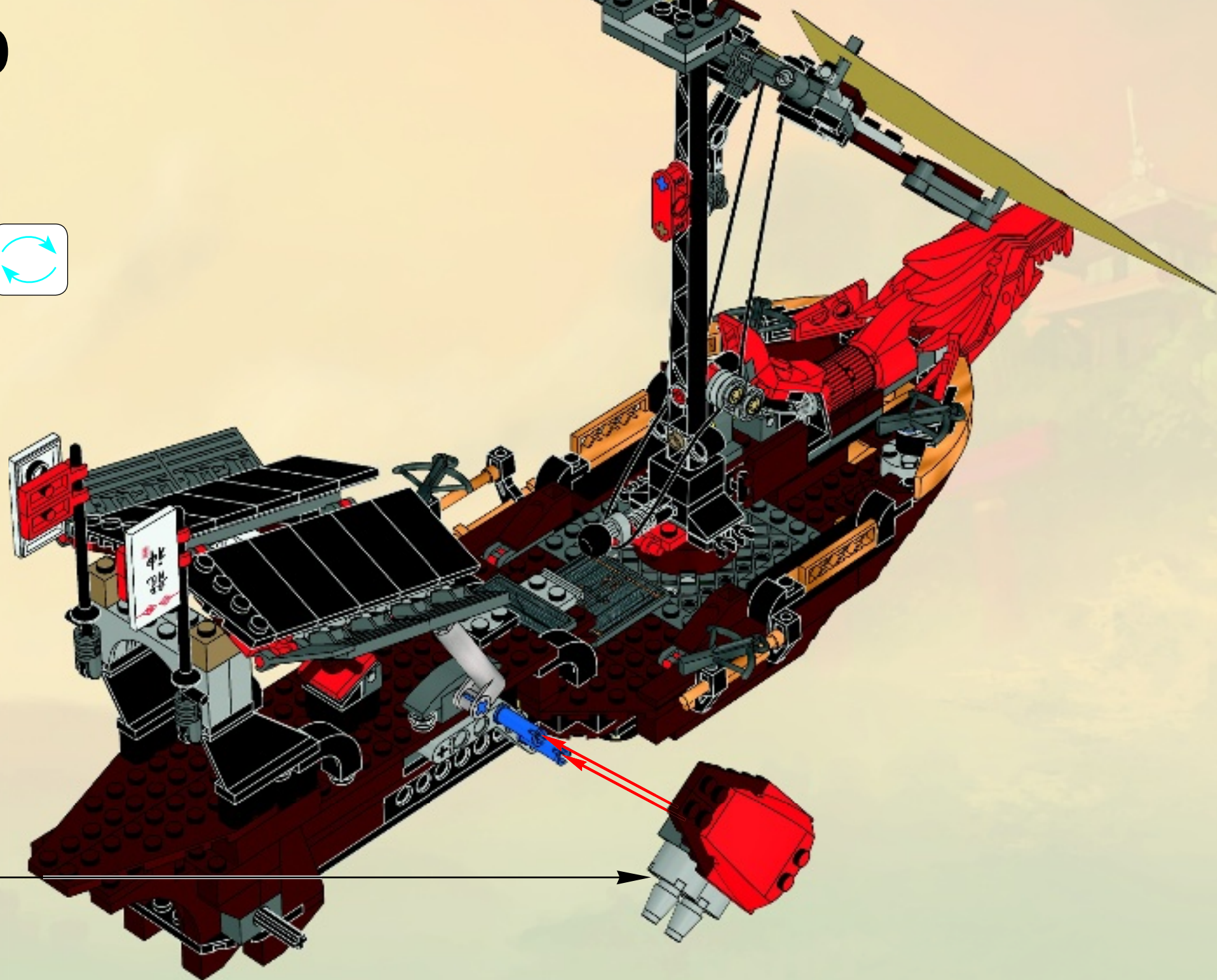
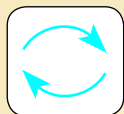

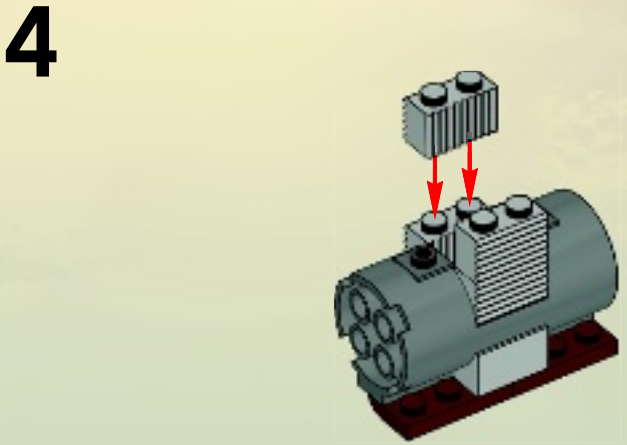
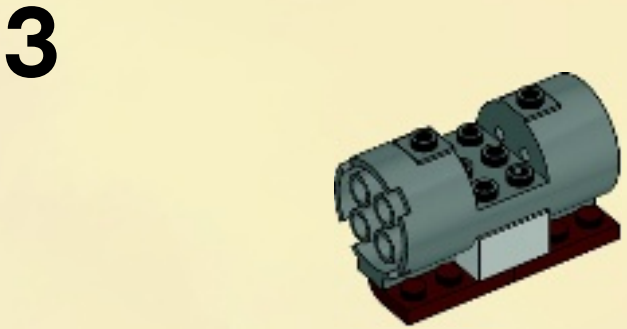
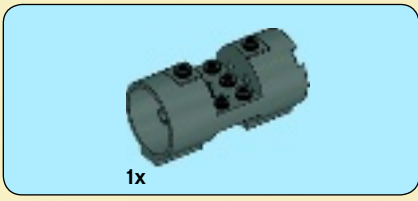
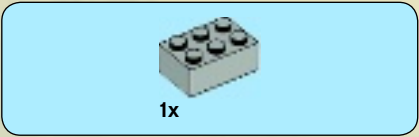
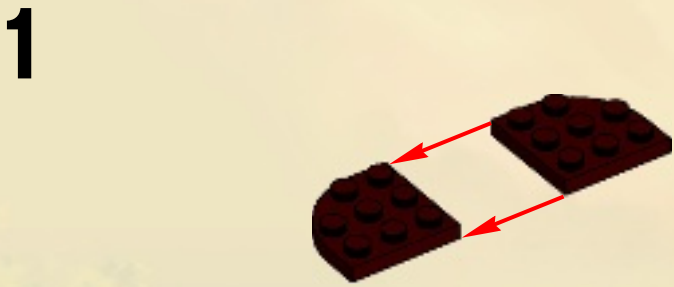
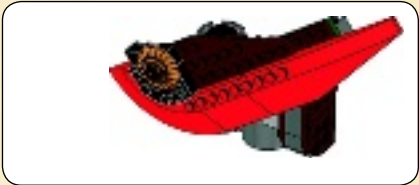
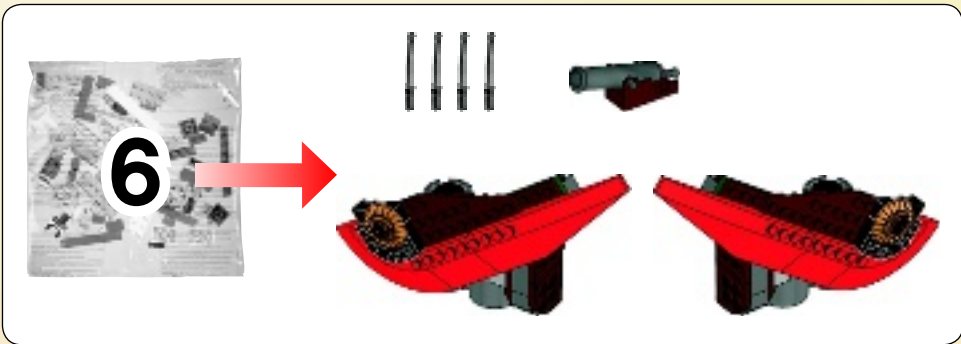

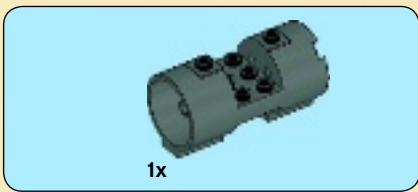

5

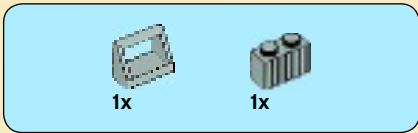
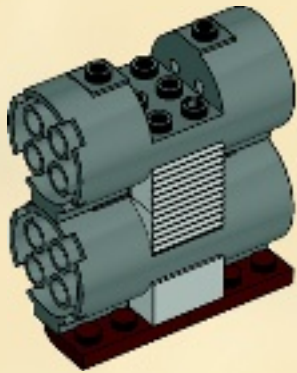

6

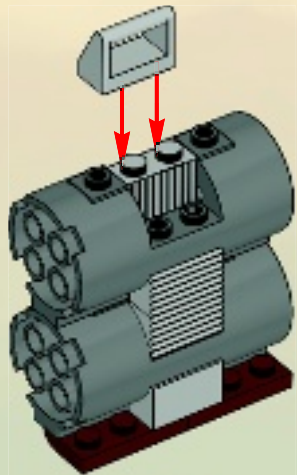

7

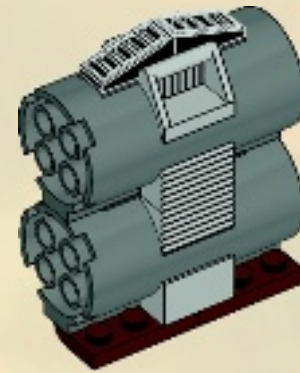

8

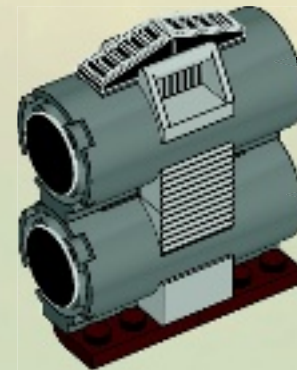
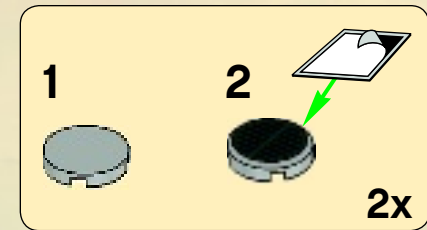



1

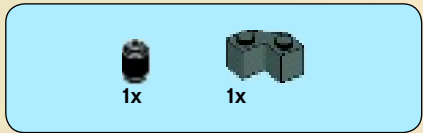

2

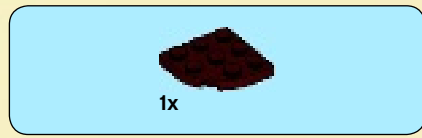

3

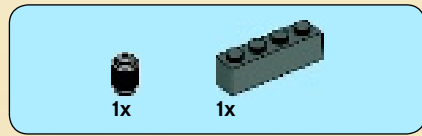

4



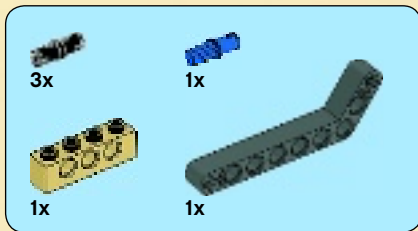

5

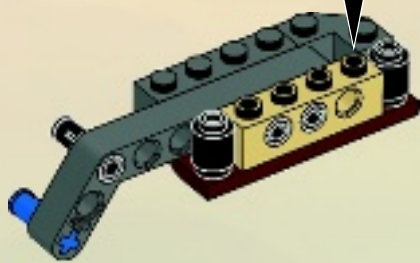
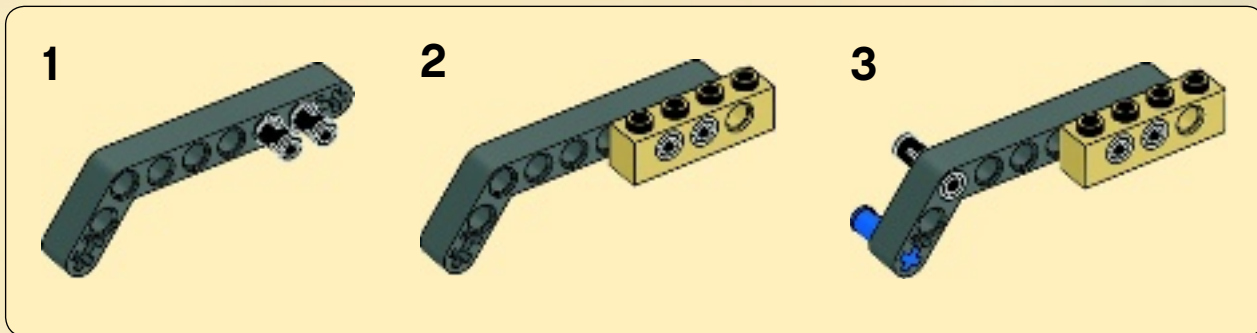

9

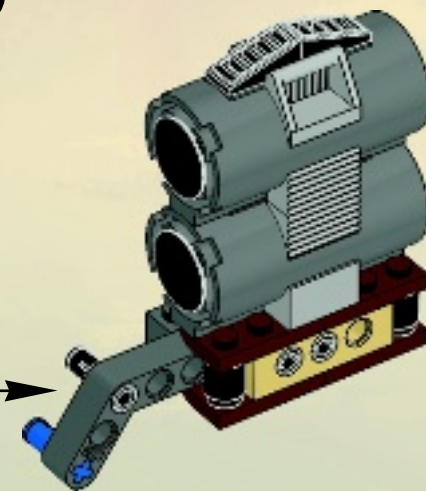

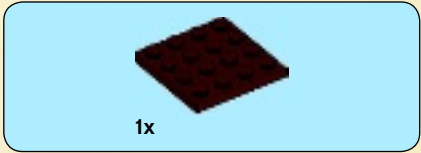
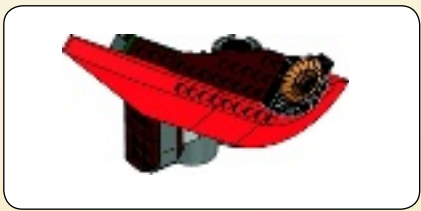

1x

1



1x

2



1x

1x

3

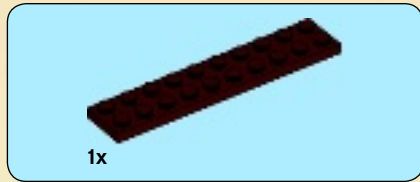

1x

4

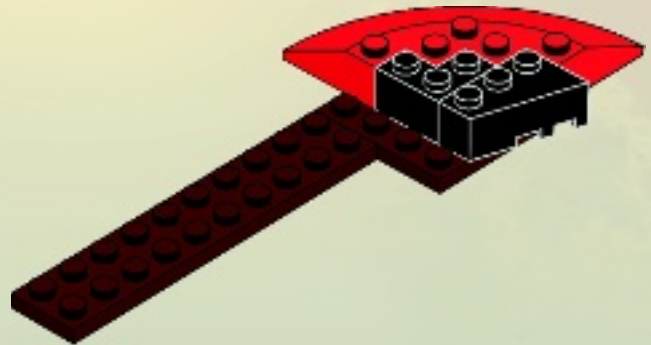

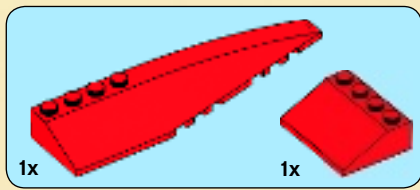

5

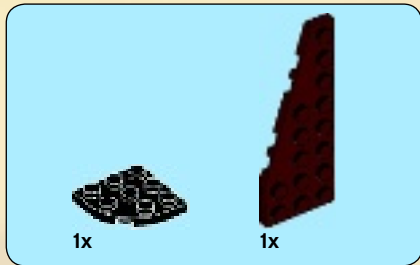
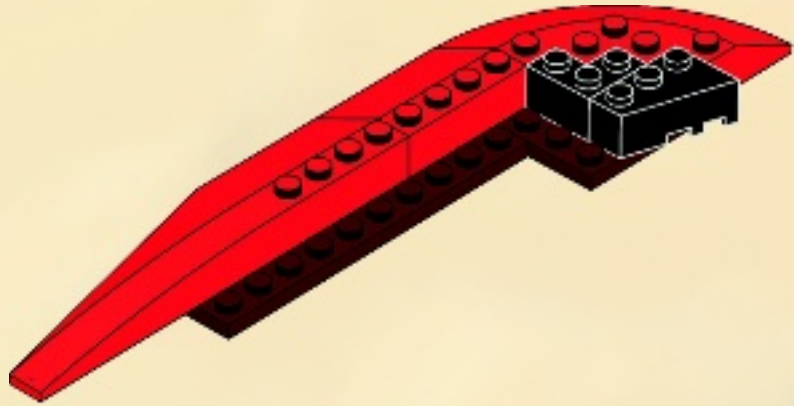

6

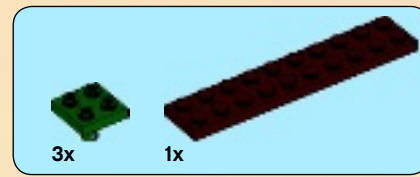
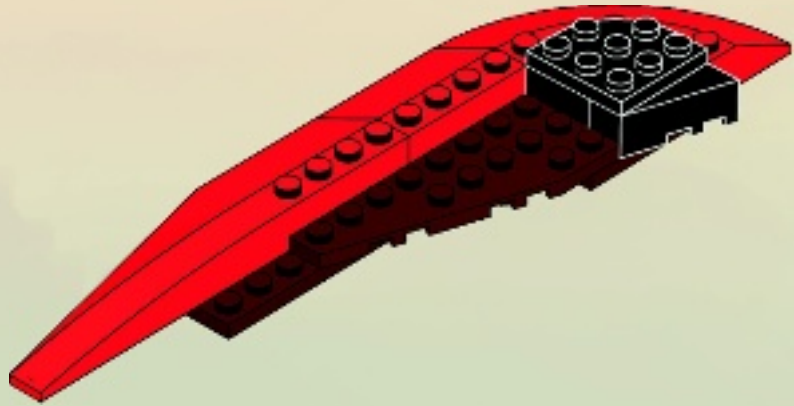

7

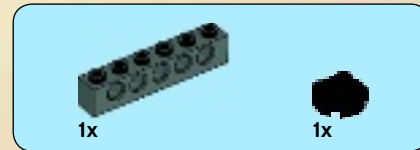
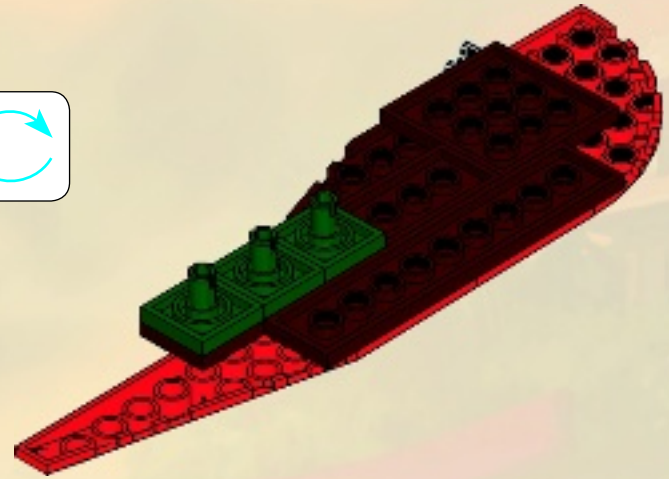
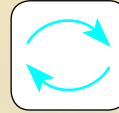

8

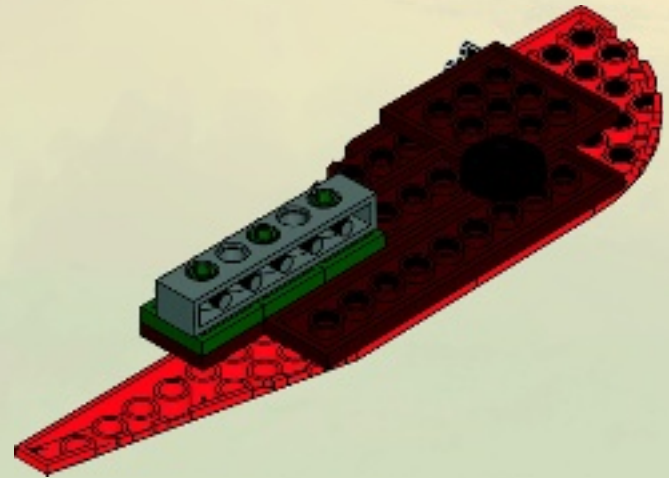

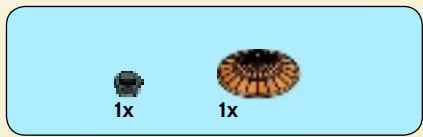

9

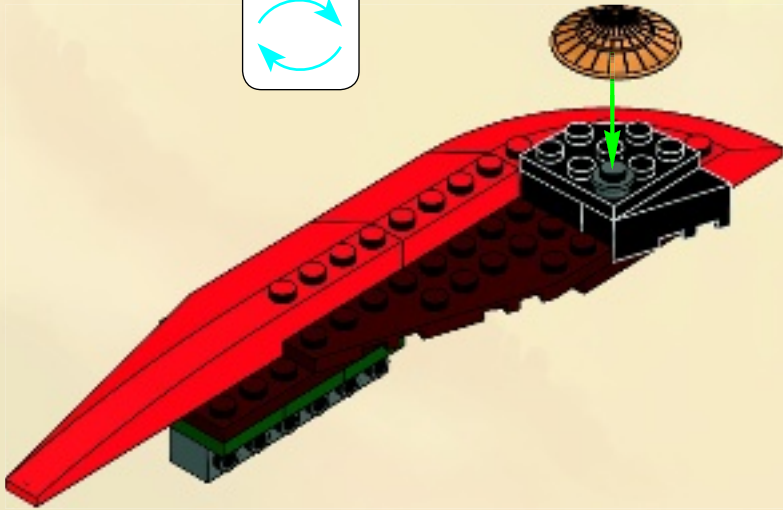

11

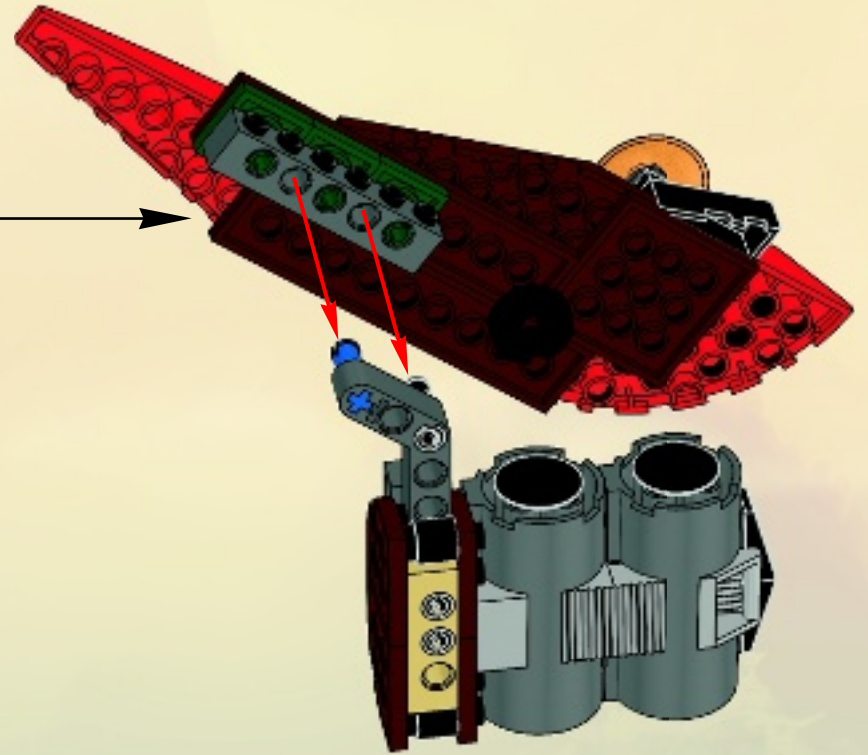

91

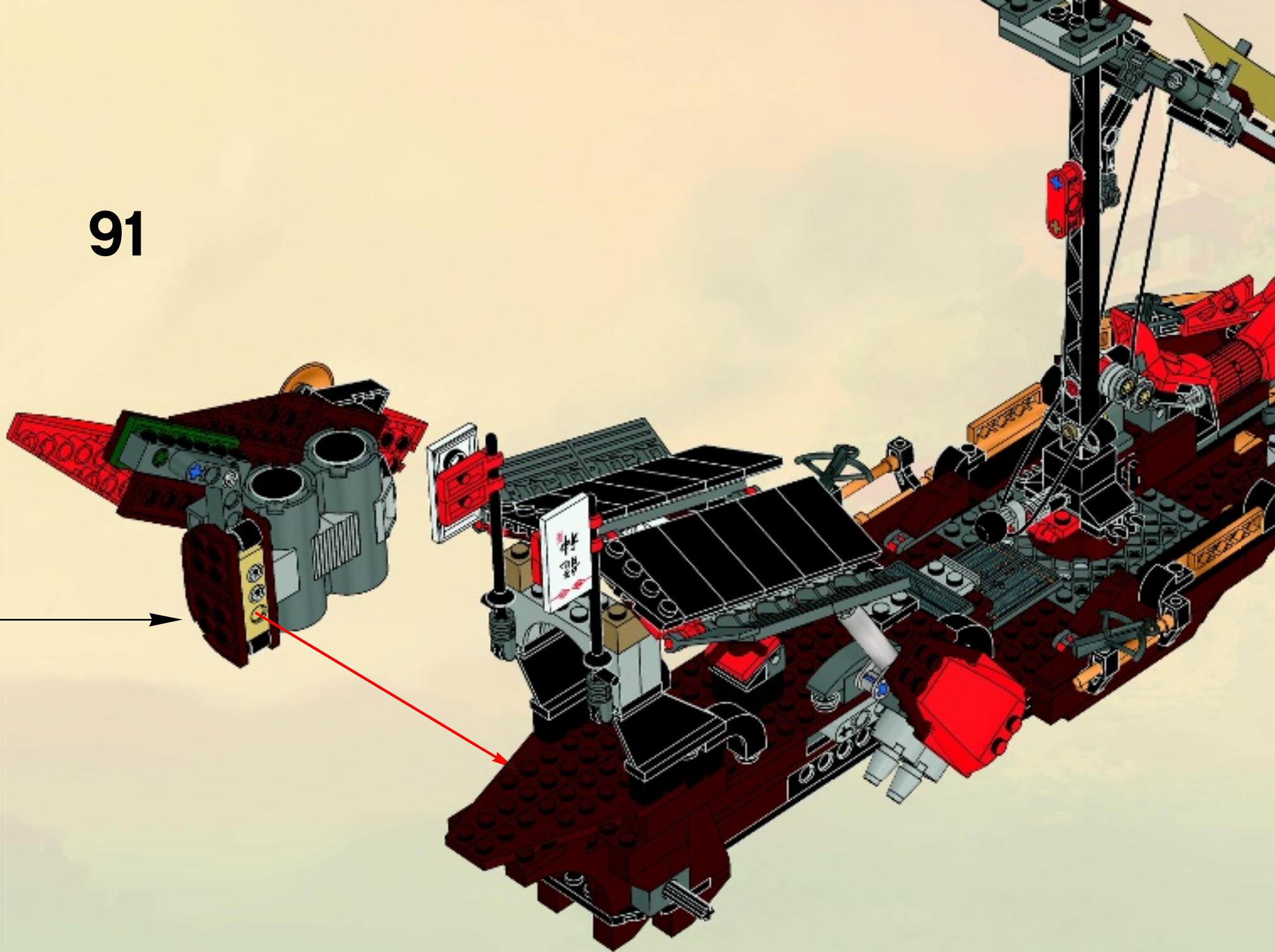

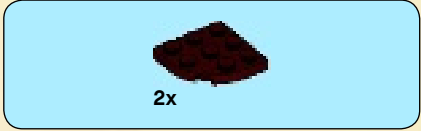
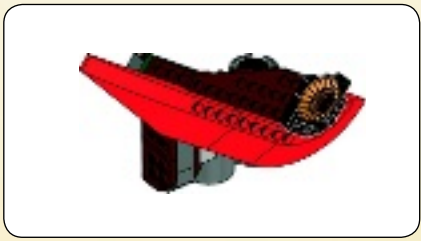

1

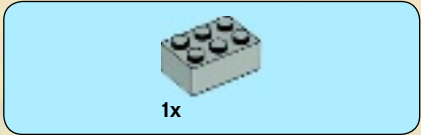
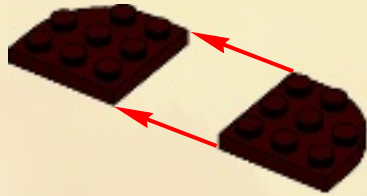

2

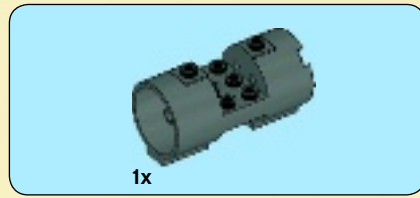

3

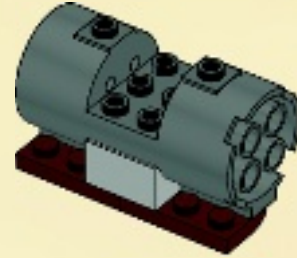

4

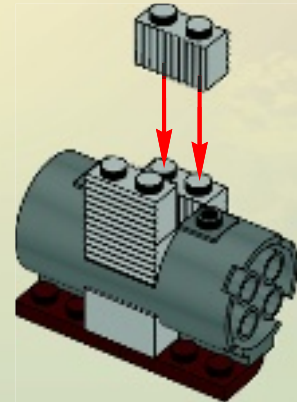

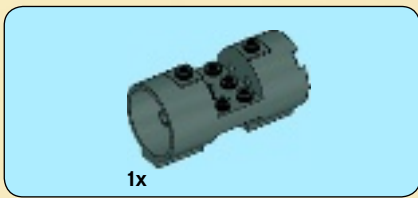

5

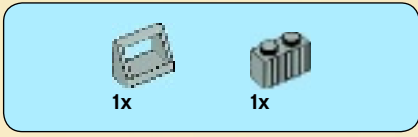
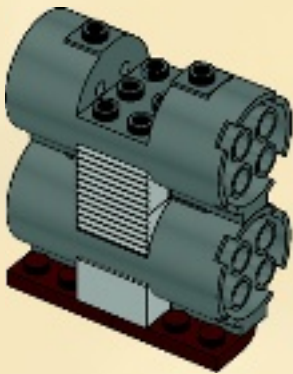

6

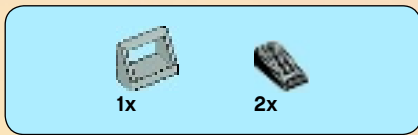
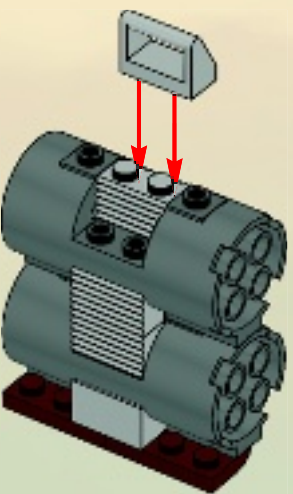

7

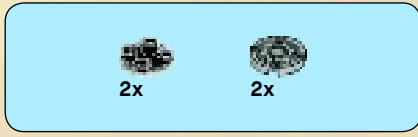
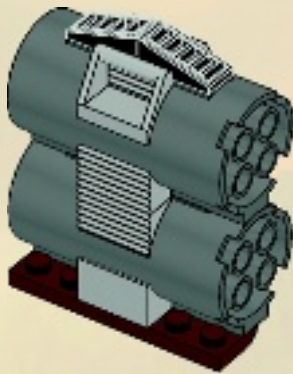

8

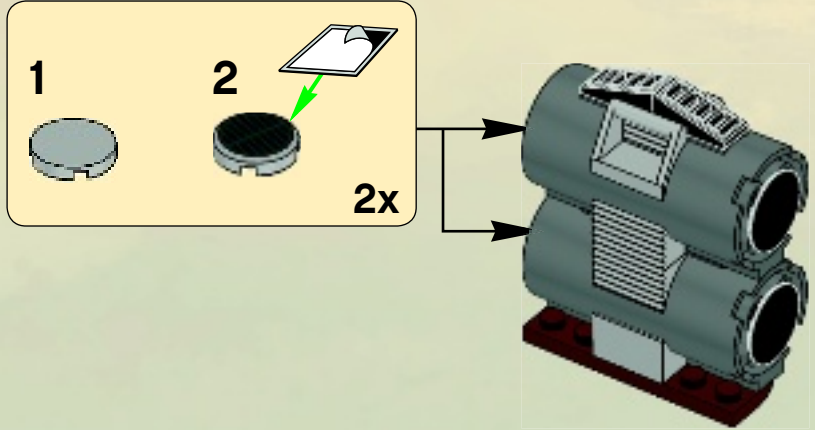



1

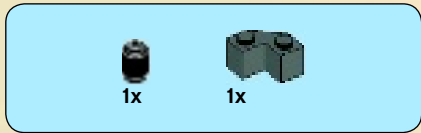

2

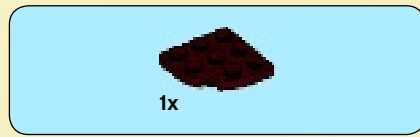

3

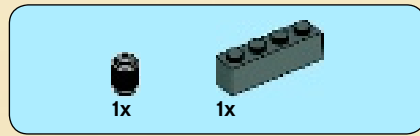

4



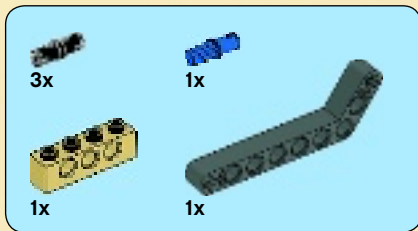

5

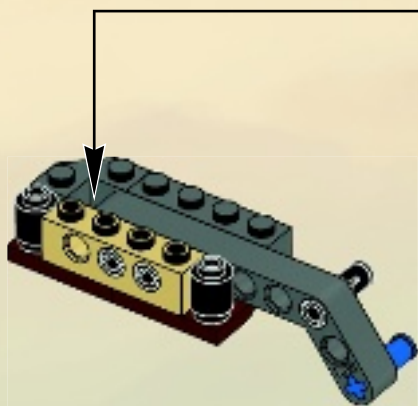
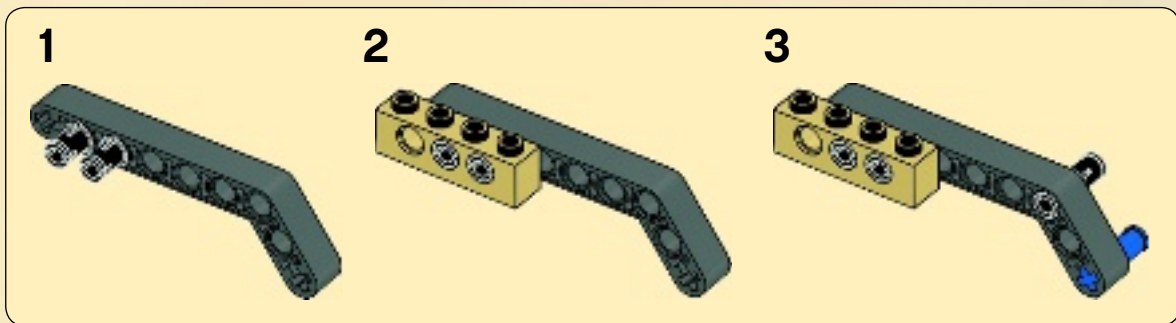

9

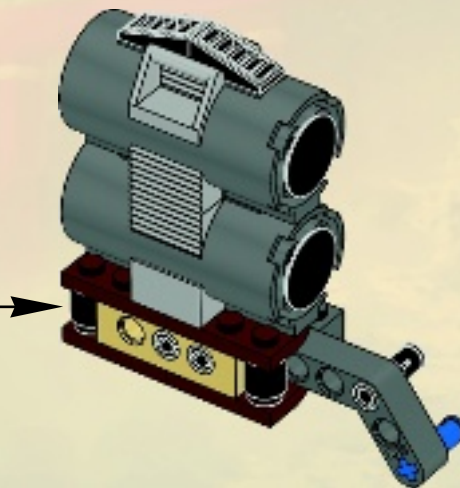

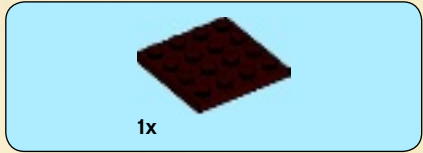

1



2

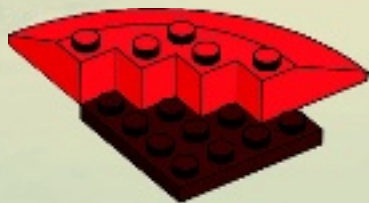

3

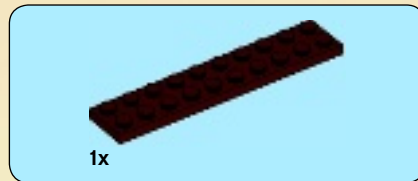

4

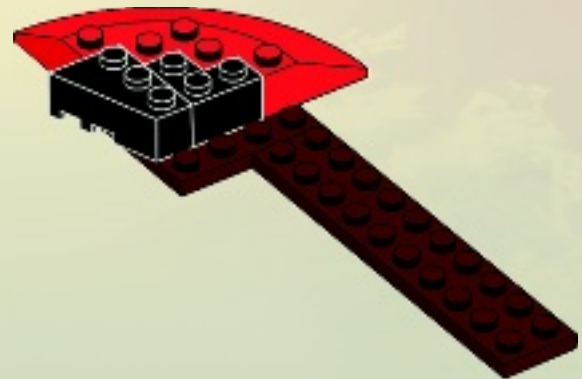
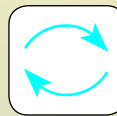

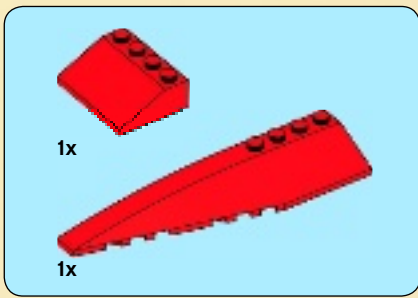

5

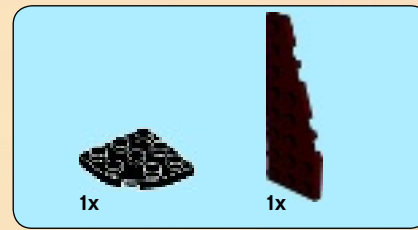
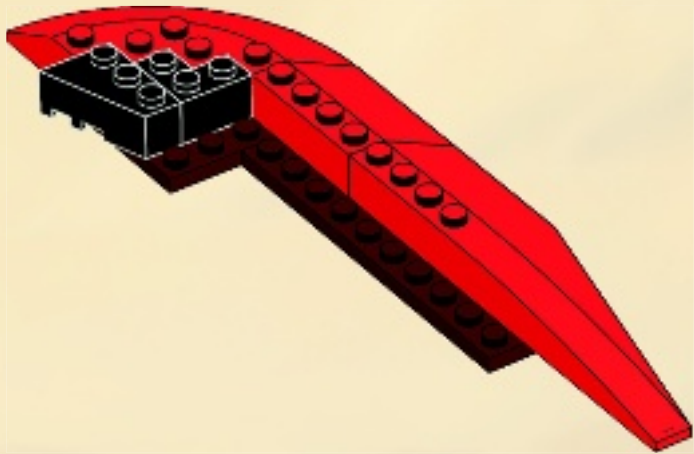

6

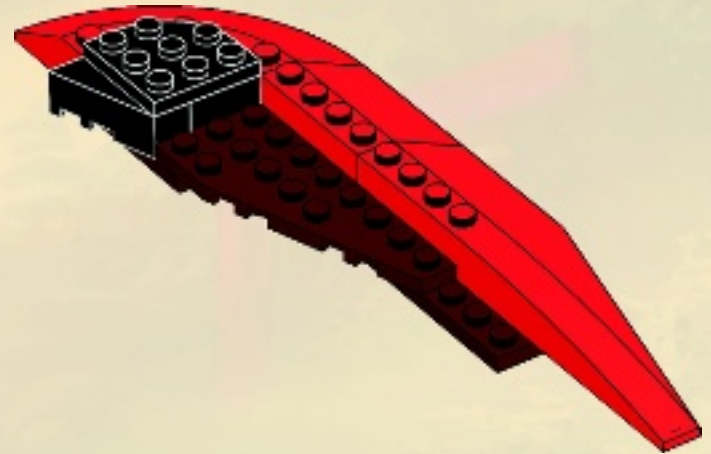

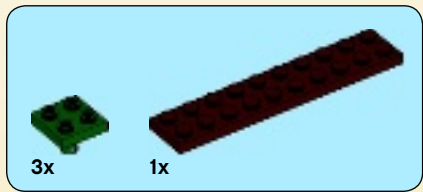

7

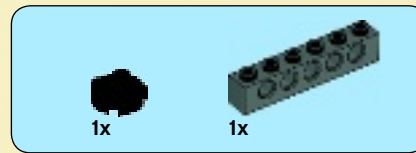
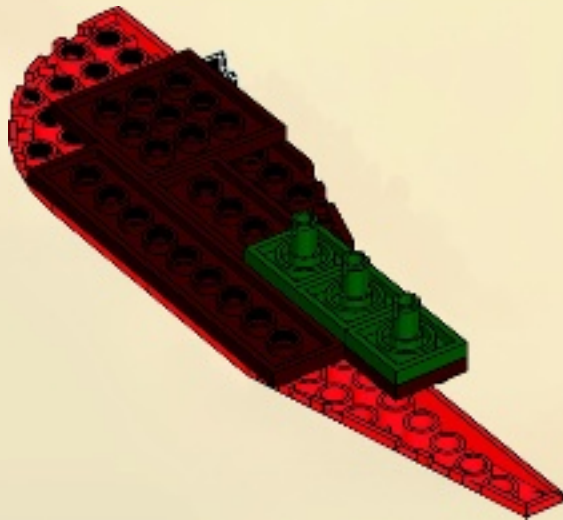

8

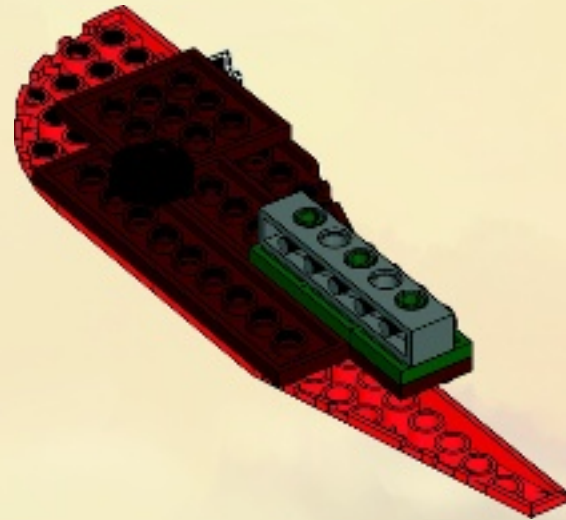

1x 1x

9

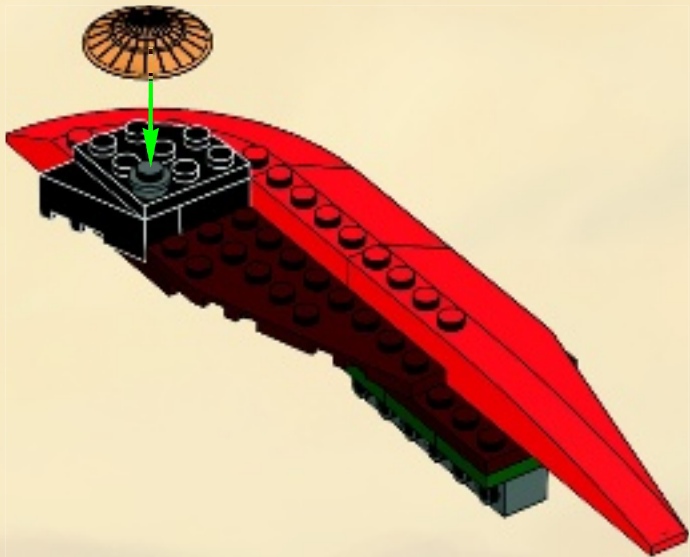

11



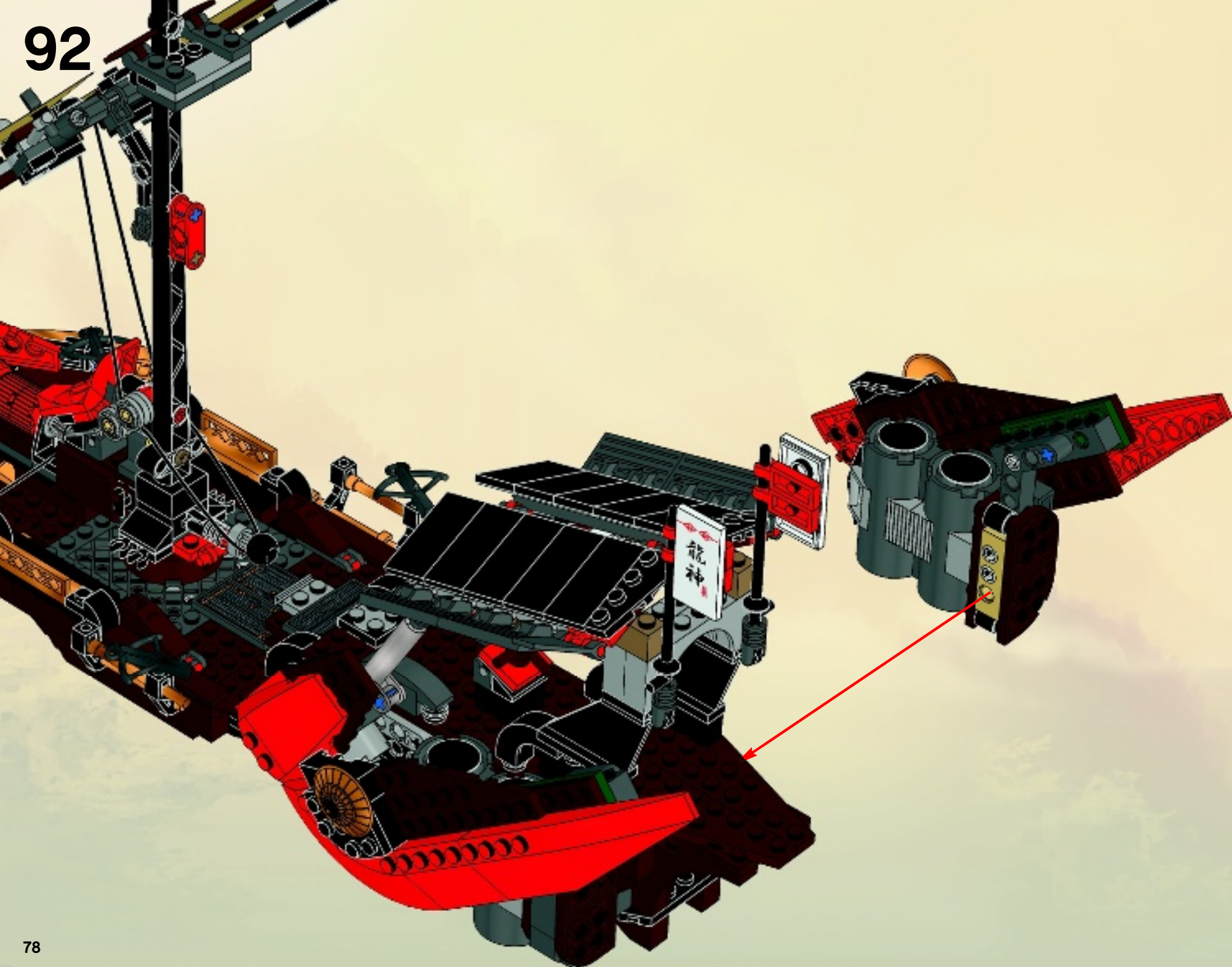

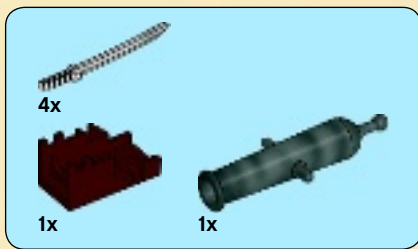

93

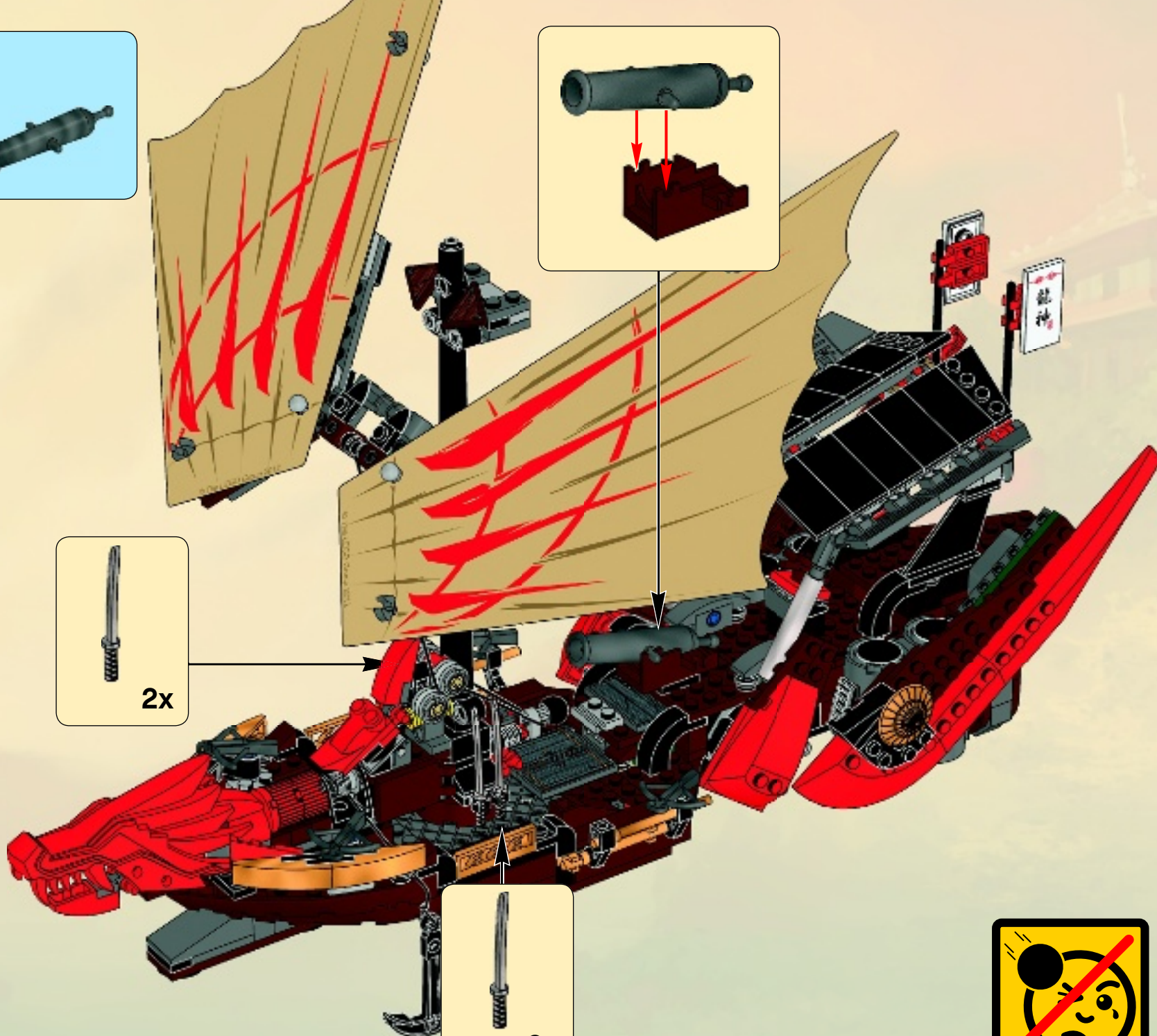
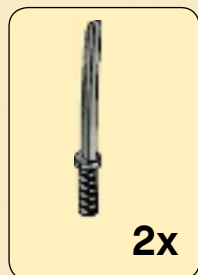
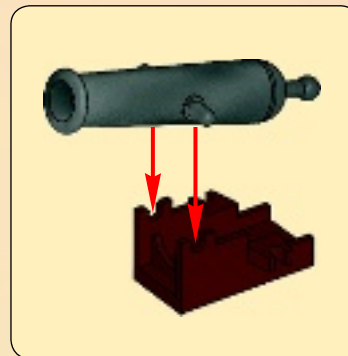

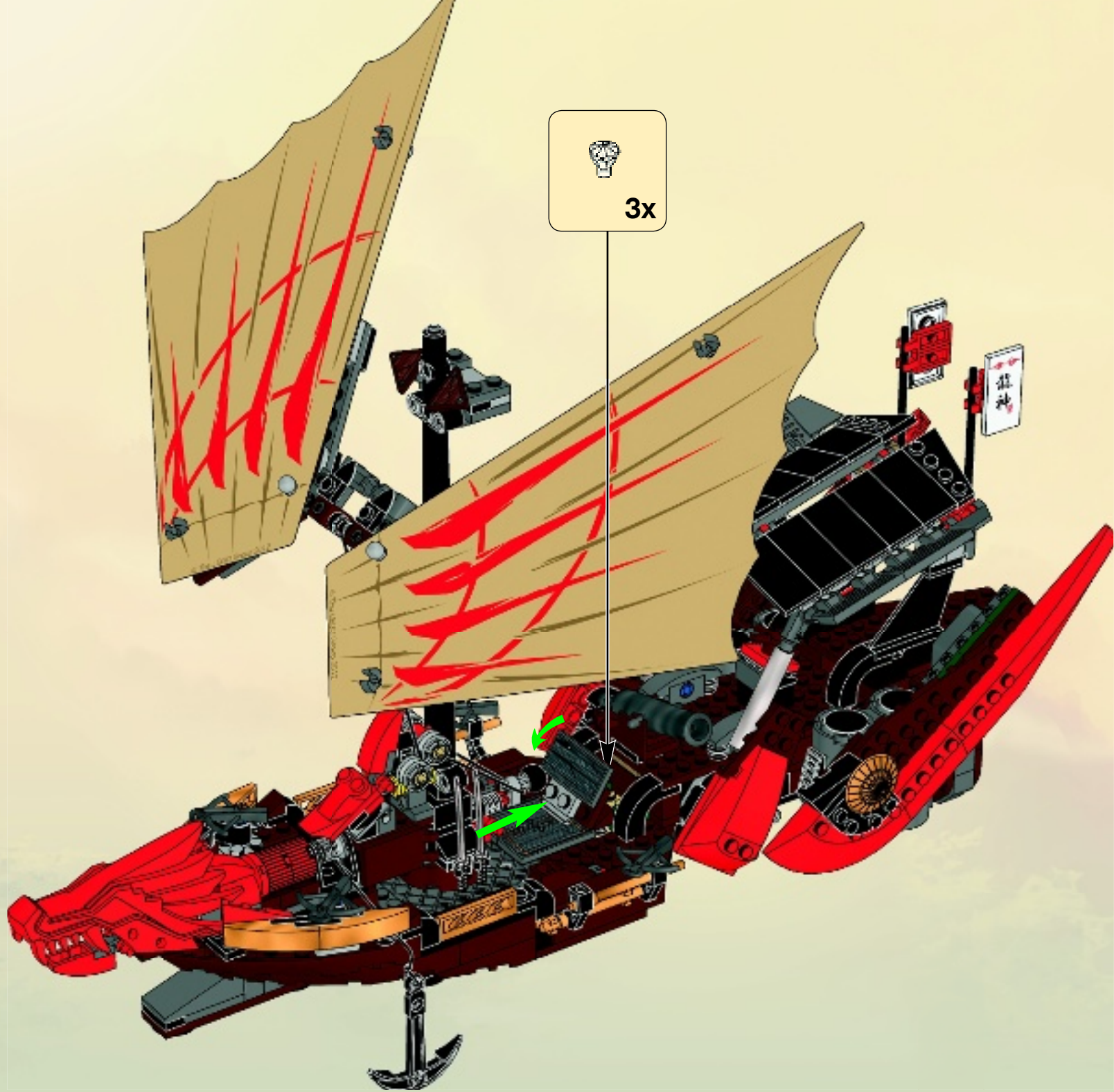

3x



- 1x 368026
- 1x 4297719
- 1x 4195022
- 1x 4290713
- 1x 4121610
- 13x 4121715
- 1x 4512363
- 2x 4119589
- 2x 370526
- 2x 370626
- 4x 235726
- 2x 292126
- 1x 4163904
- 8x 306226
- 1x 4526931
- 1x 4527766
- 6x 4550017
- 2x 4144023
- 2x 4183043
- 2x 4616245
- 10x 4560182
- 22x 614126
- 1x 4161332
- 1x 4160869
- 4x 4278359
- 3x 403226
- 2x 4651541
- 1x 4620400
- 2x 4273590
- 4x 4541191
- 1x 4143372
- 1x 258426
- 1x 4616334
- 1x 4616311
- 4x 6006739
- 1x 4650761
- 4x 4548180
- 8x 609126
- 4x 4618880
- 28x 302326
- 5x 371026
- 2x 4227392
- 1x 4129572
- 2x 384926
- 4x 4514845
- 2x 370326
- 1x 4650750
- 1x 4652786
- 1x 4243824
- 2x 4234365
- 1x 4630045
- 6x 4278422
- 1x 4609291
- 2x 4514554
- 1x 4539063
- 1x 4646496
- 1x 4646495
- 1x 4667793
- 1x 4612649
- 2x 4168114
- 8x 4206482
- 4x 4514553
- 6x 4612735
- 2x 4528713
- 3x 4248937
- 1x 4653400
- 2x 4107106
- 1x 4124054
- 1x 256949
- 6x 4646577
- 2x 4530678
- 1x 4653511
- 1x 4496699
- 4x 4566927
- 3x 4186627
- 1x 4645494
- 1x 4648081
- 1x 4648087
- 1x 4646518
- 2x 4611100
- 2x 4517594
- 1x 4538724
- 2x 4211200
- 2x 4216668
- 5x 4211201
- 7x 4211193
- 1x 4223681
- 10x 4504376
- 4x 4211222
- 2x 4270470
- 2x 4271949
- 2x 4544525
- 2x 4211204
- 2x 4585337
- 2x 4544167
- 8x 4211186
- 8x 4221590
- 3x 4243838
- 4x 4271874
- 2x 4211211
- 2x 4223683
- 6x 4211214
- 4264669
- 2x 4205469
- 2x 4205470
- 2x 4651392
- 2x 4651391
- 10x 4283660
- 2x 4224732
- 1x 4211185
- 6x 4211195
- 1x 4252456
- 1x 4538718
- 1x 4251378
- 2x 302328
- 2x 4650646
- 2x 4179355
- 2x 329721
- 1x 4521852
- 3x 4251162
- 1x 415021
- 2x 4597713
- 5x 4140585
- 6x 4534648
- 1x 246021
- 1x 4180504
- 1x 4180533
- 1x 4128598
- 1x 4560172
- 2x 4227155
- 8x 4142865
- 1x 4614777
- 2x 4649885
- 2x 4613143
- 2x 4211386
- 10x 4211383
- 3x 4211529
- 3x 4211833
- 4x 4529241
- 6x 4211475
- 5x 4211526
- 2x 6007894
- 2x 4221600
- 1x 4211398
- 1x 4599498
- 4x 4211480

- 1x 4211568
- 4x 4211840
- 2x 4262978
- 4x 4211357
- 1x 4211370
- 1x 4540203
- 1x 4211469
- 1x 4211470
- 3x 4211881
- 2x 4211668
- 4x 4211758
- 2x 4211375
- 3x 4211807
- 1x 4211815
- 1x 4211639
- 2x 4211759

- 1x 4211609
- 1x 4211088
- 2x 4211103
- 2x 4624186
- 2x 4210633
- 2x 4215387
- 7x 4211111
- 4x 4213607
- 2x 4210917
- 2x 4210963
- 1x 4211054
- 1x 4210637
- 2x 4648256
- 4x 4211094
- 6x 4211133
- 2x 4211043

- 6x 4210998
- 2x 4211069
- 2x 4579354
- 1x 4210763
- 4x 4196768
- 6x 4521187
- 2x 4217558
- 3x 4560184
- 4x 4611708
- 1x 4260707
- 1x 4299022
- 1x 4210886
- 4x 4645091

- 2x 4649635
- 2x 4612797
- 4x 4289542
- 2x 4210695
- 3x 4211066
- 2x 4281516
- 2x 4210658
- 2x 4210688
- 1x 4516546
- 2x 4210665
- 2x 4508553
- 4x 4649538
- 4x 4523160
- 2x 4536675
- 4x 4600270

- 2x 4649896
- 2x 4617761
- 1x 4640843
- 1x 4646828
- 1x 4646871
- 6x 4286597
- 15x 4519970
- 2x 4518557
- 3x 4518687
- 13x 4623298
- 1x 4636105
- 4x 4612900
- 2x 4646867
- 2x 4609612
- 4x 4617248

- 1x 4646806
- 1x 4638950
- 2x 300101
- 2x 4612857
- 1x 4667795
- 1x 4651720
- 1x 4612637
- 1x 4651703
- 1x 4600294
- 1x 4609289
- 2x 4118980
- 1x 4611427
- 1x 4611429
- 4x 4239601
- 1x 4611432

- 3x 4541980
- 1x 4651357
- 2x 4612857
- 1x 4667795
- 1x 4651720
- 1x 4612637
- 1x 4651703
- 1x 4600294
- 1x 4609289
- 2x 4118980
- 1x 4611427
- 1x 4611429
- 4x 4239601
- 1x 4611432

- 1x 4649529
- 1x 4651359
- 1x 4653617
- 1x 4653733
- 1x 4528334
- 1x 4263506

Customer Service
 Kundenservice
 Service Consommateurs
 Servicio Al Consumidor

www.lego.com/service or dial

: 00800 5346 5555
 : 1-800-422-5346



WIN!

Go to www.LEGOsurvey.com/product to fill out a survey for a chance to win a cool LEGO® Product.

No purchase necessary.

Open to all residents where not prohibited.



www.LEGO.com



www.LEGOsurvey.com/product

GEWINNE!

Nimm an der Umfrage auf www.LEGOsurvey.com/product teil und hab die Chance ein cooles LEGO® Produkt zu gewinnen!

Die Teilnahme am Gewinnspiel führt zu keinerlei Kaufverpflichtungen. Teilnahme in allen nicht ausgeschlossenen Ländern möglich.

WIN!

Ga naar www.LEGOsurvey.com/product, vul een enquêteformulier in en maak kans op een cool LEGO® product.

Geen aankoopverplichting. Iedereen mag deelnemen, uitgezonderd ingezetenden van landen waar een enquêteverbod geldt.

GAGNE!

Visite www.LEGOsurvey.com/product pour répondre à un questionnaire et avoir une chance de gagner un produit LEGO® très cool!

Aucune obligation d'achat. Ouvert à tous les résidents des pays autorisés.

当てよう!

www.LEGOsurvey.com/product にアクセスして、アンケートにご記入ください。当選者にはレゴ®製品を差し上げます。

お買い上げの必要はありません。禁止されていない限り、すべての皆様にご利用いただけます。