



Architecture

21028

New York City

New York, USA

Booklet available in English on
Heft in deutscher Sprache erhältlich auf
Livret disponible en français sur
Libretto disponibile in italiano su
Folleto disponibile en español en
Folheto disponível em português em
A füzet magyarul ezen a honlapon olvasható:
Buklets latviešu valodā pieejams vietnē
如需中文版手册, 请访问

LEGO.com/architecture

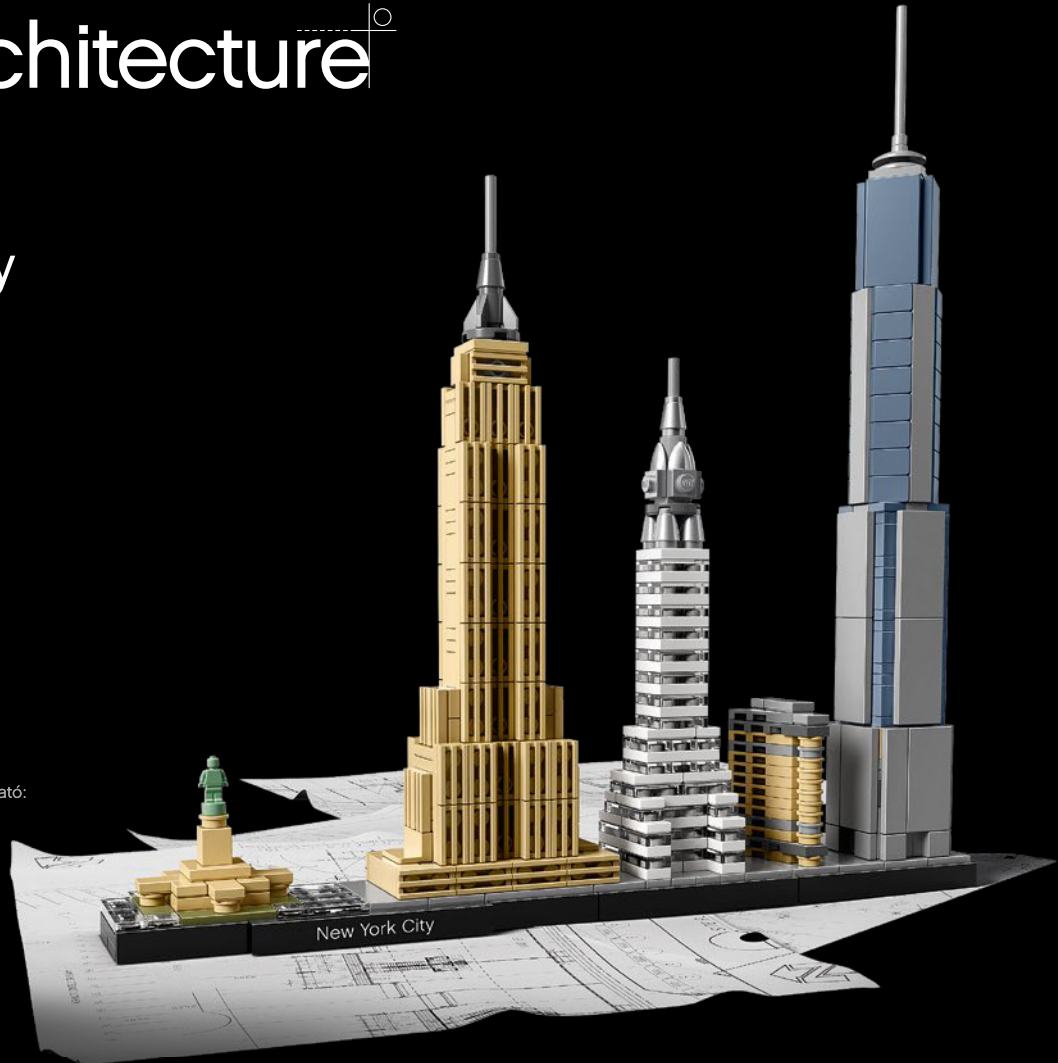

New York City

Home to one of the most iconic skylines in the world, New York City sits at the point where the Hudson River meets the Atlantic Ocean.

The city consists of five boroughs—Brooklyn, Queens, Manhattan, the Bronx and Staten Island—and can trace its roots back to 1624, when Dutch colonists founded a trading post called New Amsterdam. Renamed New York in 1664, it has been the United States' largest city since 1790. Today almost 8.5 million people live in an area of just 305 sq. miles (790 km²), which also makes it the most densely populated city in the country.

The city's architecture mixes traditional structures with modern designs, but the skyline is most famous for its skyscrapers. With more than 550 structures over 330 ft. (100 m) high, only Hong Kong has a greater number of tall buildings.

With three of the world's ten most visited attractions—Times Square, Central Park and Grand Central Station—the city is a popular tourist destination with 56 million visitors in 2014. It is often claimed that New York City is the most photographed city in the world.

[“New York is the
only real city-city.”]

Truman Capote



One World Trade Center

As the main building of the World Trade Center complex, the new One World Trade Center tower stands as both a shining beacon for the downtown business district and a bold addition to the New York skyline.

The building was completed in May 2013, when the final section of the 408 ft. (124 m) spire was installed, bringing the structure's height to a symbolic 1,776 ft. (541 m)—a deliberate reference to the year when the United States Declaration of Independence was signed.

Designed by architect David M. Childs from the New York office of Skidmore, Owings & Merrill, the tower ascends from a cubic base, its edges slanting back to form eight isosceles triangles with a perfect octagon near its middle, culminating in a glass parapet at the top.

The enclosed One World Observatory allows visitors a spectacular view of the surrounding city from 1,250 ft. (381 m) above street level. At night, an intense beam of horizontal light is projected from the spire and is visible over 1,000 ft. (300 m) above the tower.

[“There is something in the New York air that makes sleep useless.”]

Simone de Beauvoir



The Statue of Liberty

Standing on Liberty Island at the entrance to New York Harbor, the Statue of Liberty was a welcoming signal to millions of immigrants and a symbol of freedom and democracy in the United States.

Designed by the French sculptor Frédéric Auguste Bartholdi and given as a gift to the United States from the people of France, the robed female figure represents the Roman goddess Libertas. In one hand she raises a torch, in the other she holds a tablet inscribed with the date of the American Declaration of Independence, July 4, 1776.

The 151 ft. (46 m) tall copper statue was constructed in France and shipped in pieces to the completed pedestal on what was then called Bedloe's Island. The dedication ceremony in October 1886 was presided over by President Grover Cleveland and marked by New York's first ever ticker-tape parade.



The Statue of Liberty

Flatiron Building

Although never the tallest building in New York, or even the first building in the United States with a triangular ground plan, the Flatiron Building remains one of New York's most memorable structures.

Sitting on the intersection where Fifth Avenue and Broadway cross, the Flatiron's famous form was dictated by the shape of the plot of leftover land that lay undeveloped as the city raced northward during the second half of the 19th century. In 1901 the architect Daniel H. Burnham was hired to design a new showcase headquarters on the site for Chicago-based contractors The Fuller Company.

Burnham's radical design created a great deal of debate as the massive structure neared completion in 1902. Many New Yorkers believed that the unstable building would fall over at the first gust of wind. The Flatiron withstood both the criticism and the strong winds and, over a century later, stands tall as a groundbreaking engineering marvel.

Valued today at \$190 million, the Flatiron Building continues to function as a popular retail and office space. In 2009, Sorgente Group of America acquired the majority of the Flatiron Building.



Chrysler Building™

At 1,046 ft. (319 m) the Chrysler Building was the world's tallest building for 11 months before being surpassed by the Empire State Building in 1931. It remains the tallest steel-supported brick building in the world and is seen as an outstanding example of classic Art Deco architecture.

It was designed by New York architect William Van Alen for Walter P. Chrysler, chairman of the Chrysler Corporation, and construction commenced in September 1928. Almost 400,000 rivets were used in the creation of the steel skeleton and over 3.8 million bricks were manually laid as the building took shape.

As the building would be the headquarters for an automobile company, many of the architectural details including the gargoyles were modeled after Chrysler automobile parts. The iconic stainless-steel crown is composed of seven radiating arches ending in a 125 ft. (38 m) long spire.

Declared a US National Historic Landmark in 1976, the Chrysler Building is consistently rated one of the finest buildings in New York by architects and scholars. Since the observation deck on the 71st floor officially closed in 1945, visitors today can still view the spectacular Art Deco lobby.

[“The Chrysler Building...
was one of the
most accomplished
essays in the style.”]

John Julius Norwich



Chrysler Building

Empire State Building

Located in Midtown Manhattan on Fifth Avenue between West 33rd and West 34th streets, the 1,454 ft. (443 m) tall skyscraper was the world's tallest building when it was completed in April 1931. It remained so for nearly 40 years and is still the fourth tallest skyscraper in the United States and the 25th tallest in the world.

Named after the nickname for the State of New York, the Empire State, the distinctive Art Deco-style structure was designed by Brooklyn-born architect William F. Lamb. Construction began in early 1930 and was completed only 410 days later—12 days ahead of schedule. President Herbert Hoover officially opened the 102-story building on May 1, 1931 when he turned on the building's lights directly from Washington.

Over 4 million tourists visit the building's 86th floor observation deck every year to experience a unique panoramic view of New York City. Widely regarded as

an American cultural icon, the Empire State Building was hailed as one of the Seven Wonders of the Modern World by the American Society of Civil Engineers in 1994.

[“From the ruins, lonely
and inexplicable as
the sphinx, rose the
Empire State Building”]

F. Scott Fitzgerald



Empire State Building

["... it's probably the only city which
in reality looks better than on the
postcards, New York."]

Milos Forman



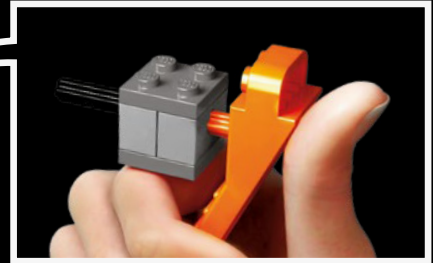
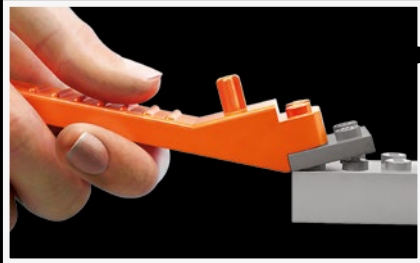
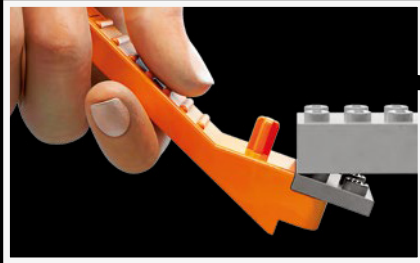

LEGO.com/brickseparator

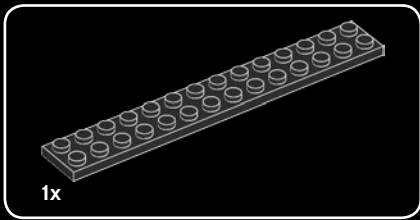

1

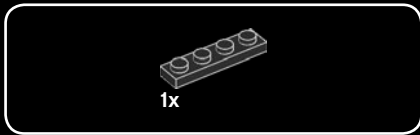
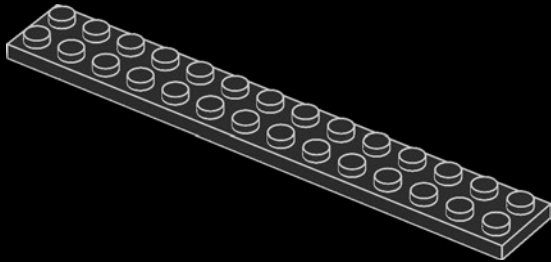

2

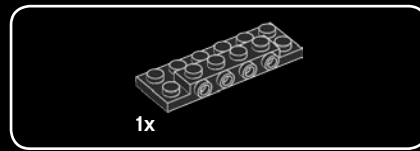
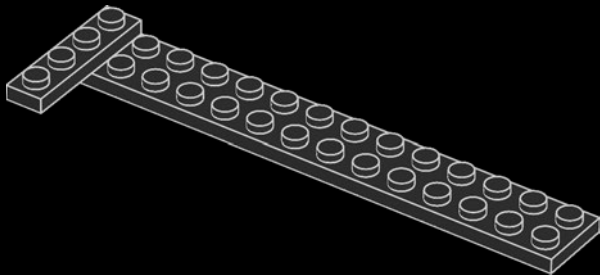

3

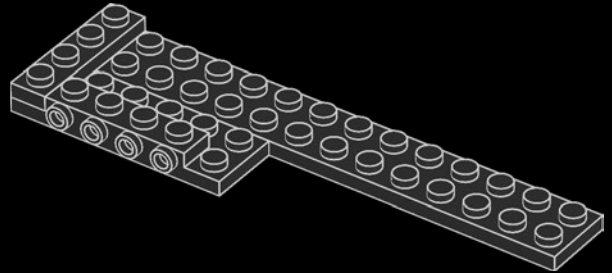

4

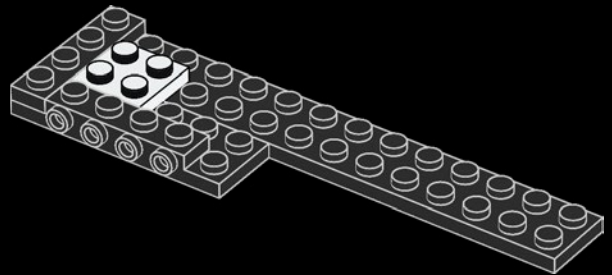

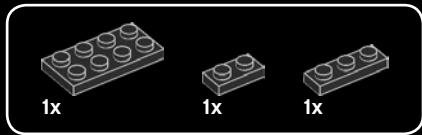

5

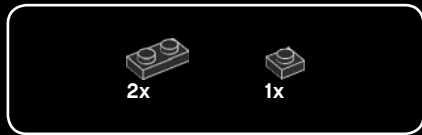
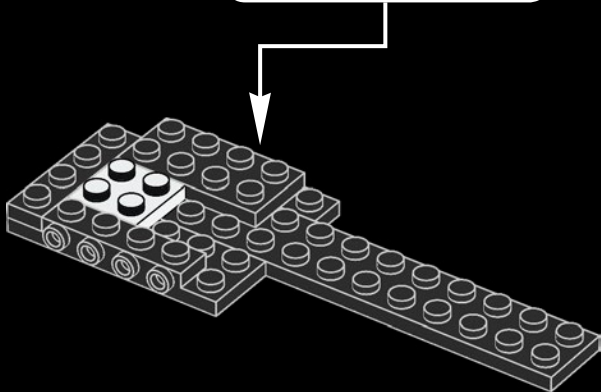
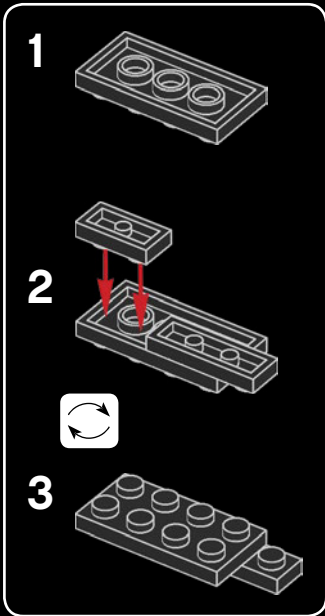

6

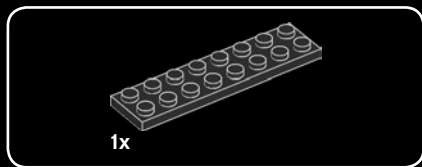
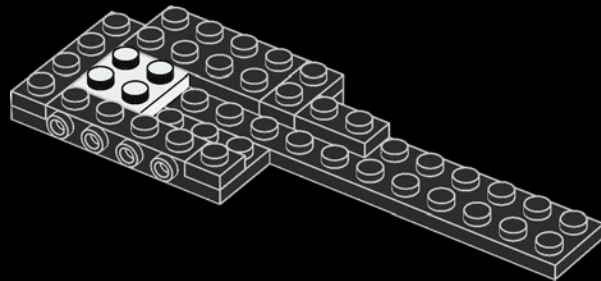

7

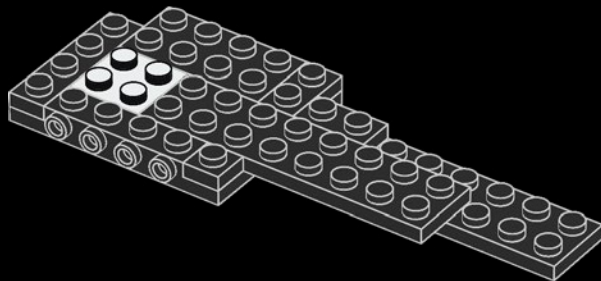

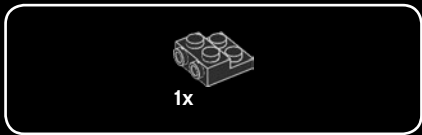

8

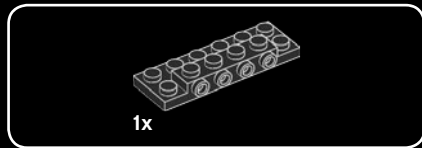
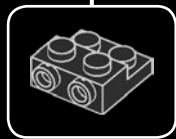
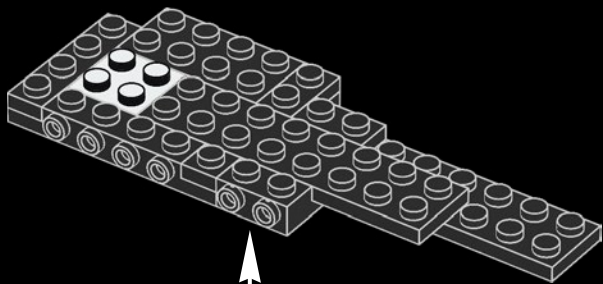

9

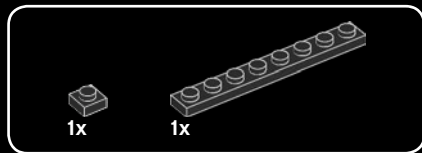
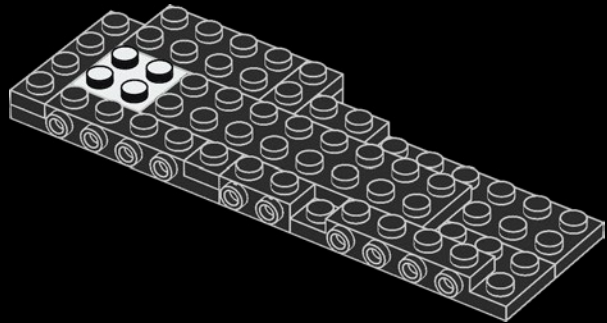

10

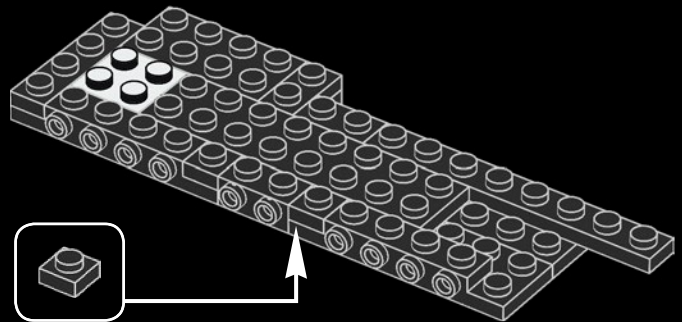

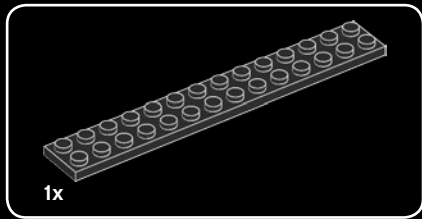

11

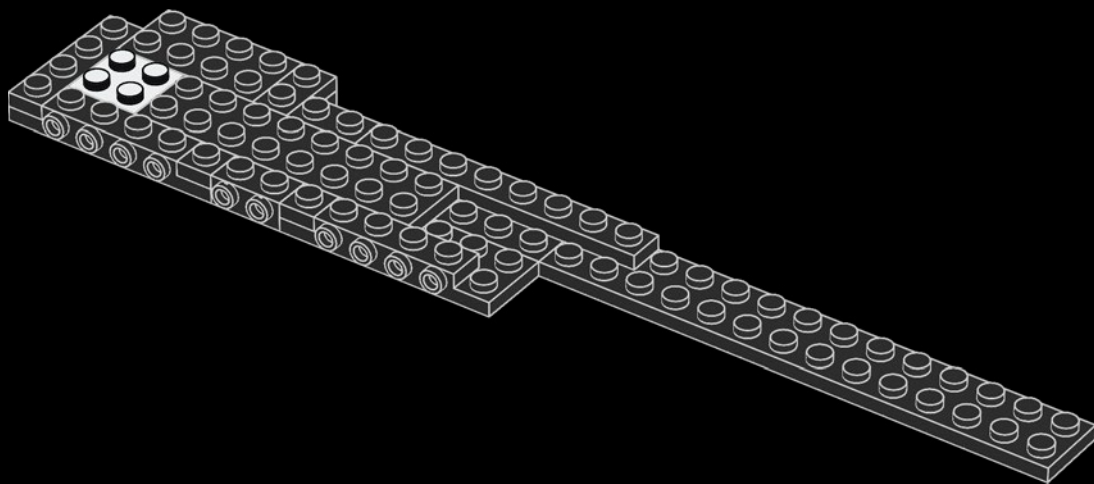

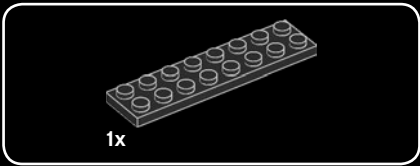

12

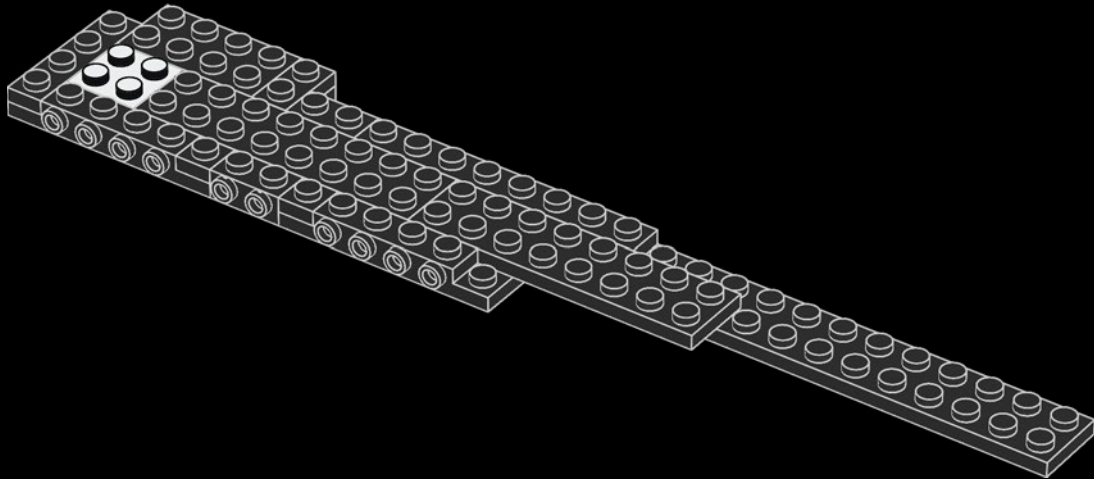

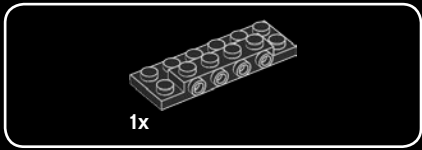

13

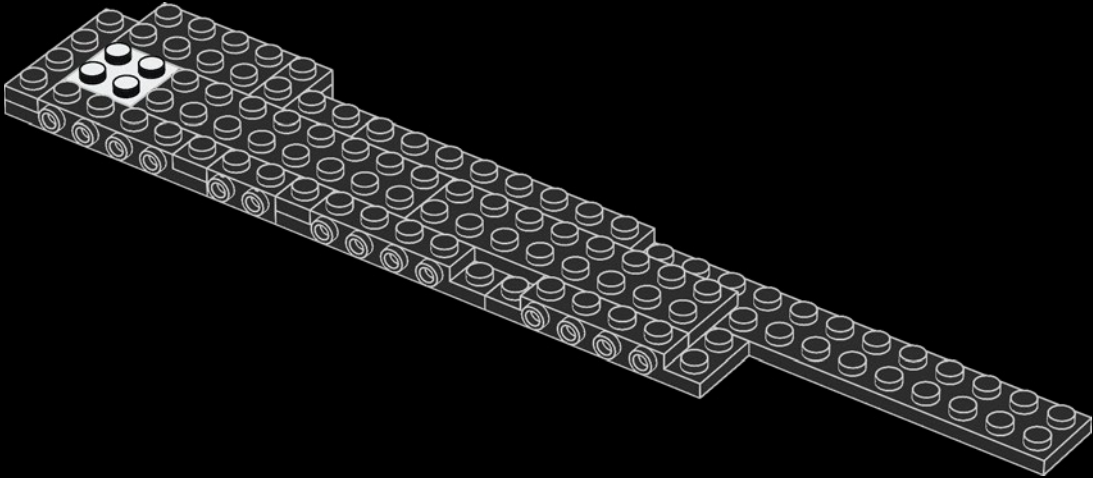

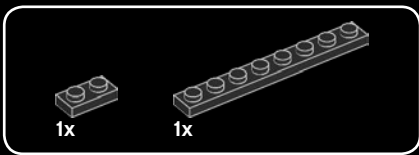

14

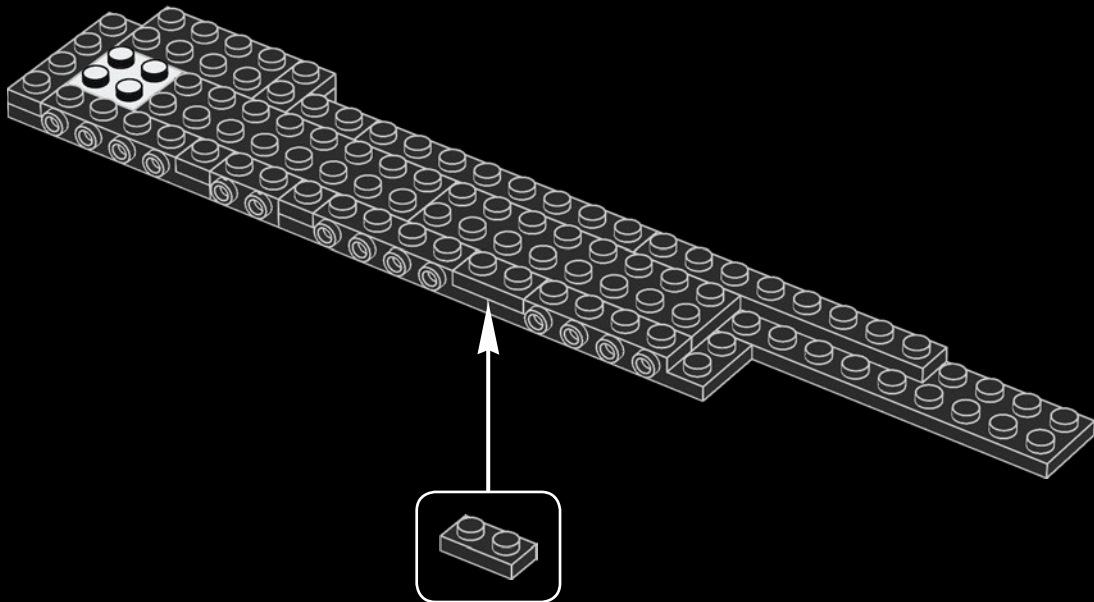

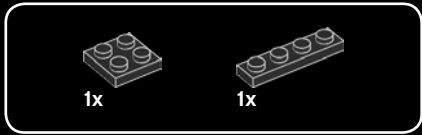

15

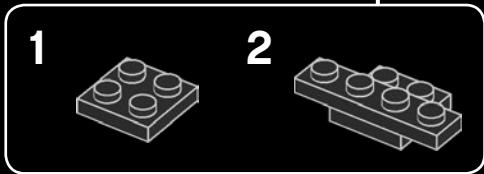
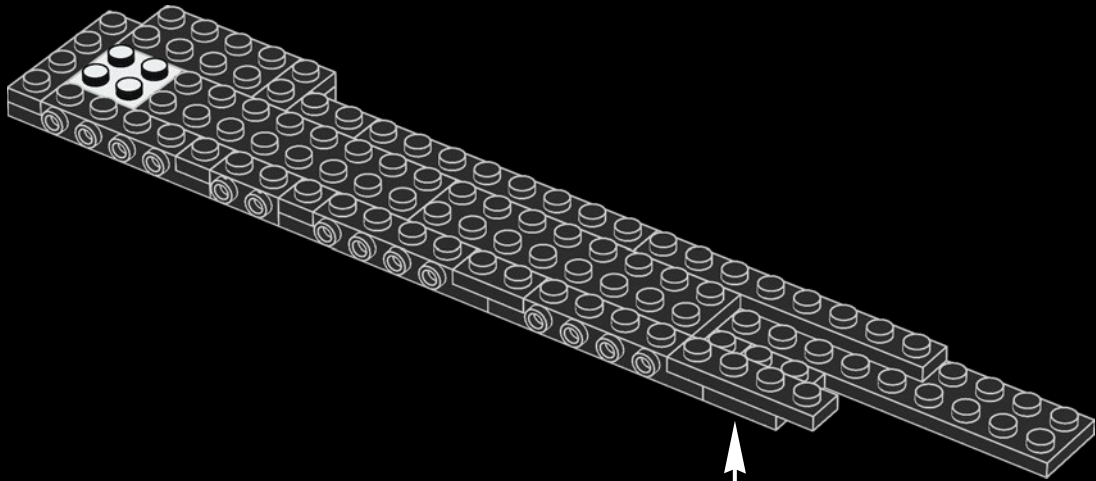

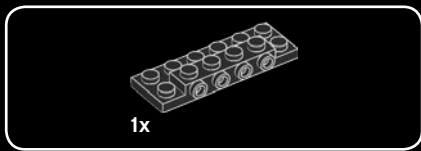

16

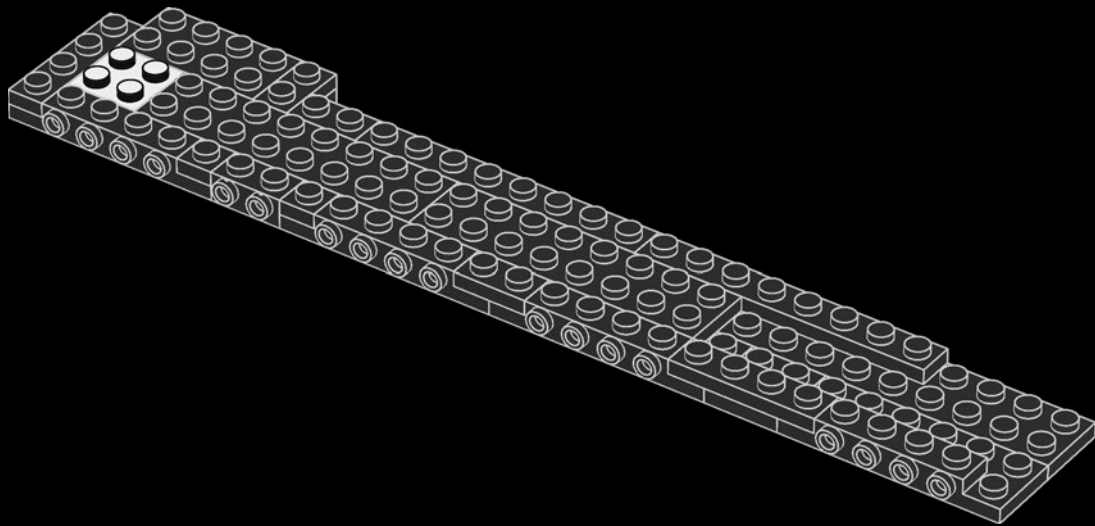

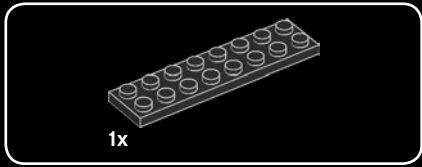

17

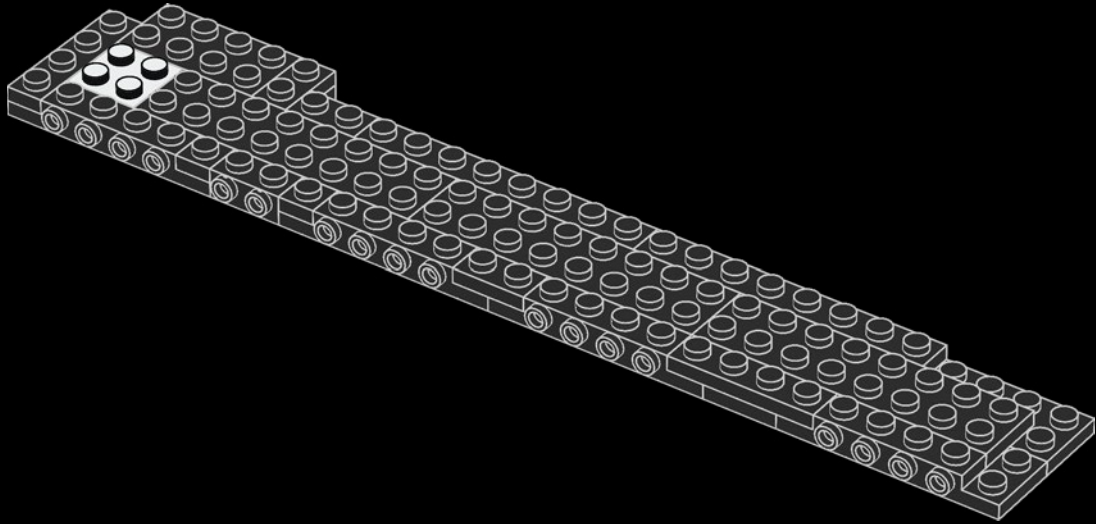

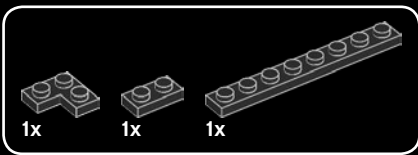

18

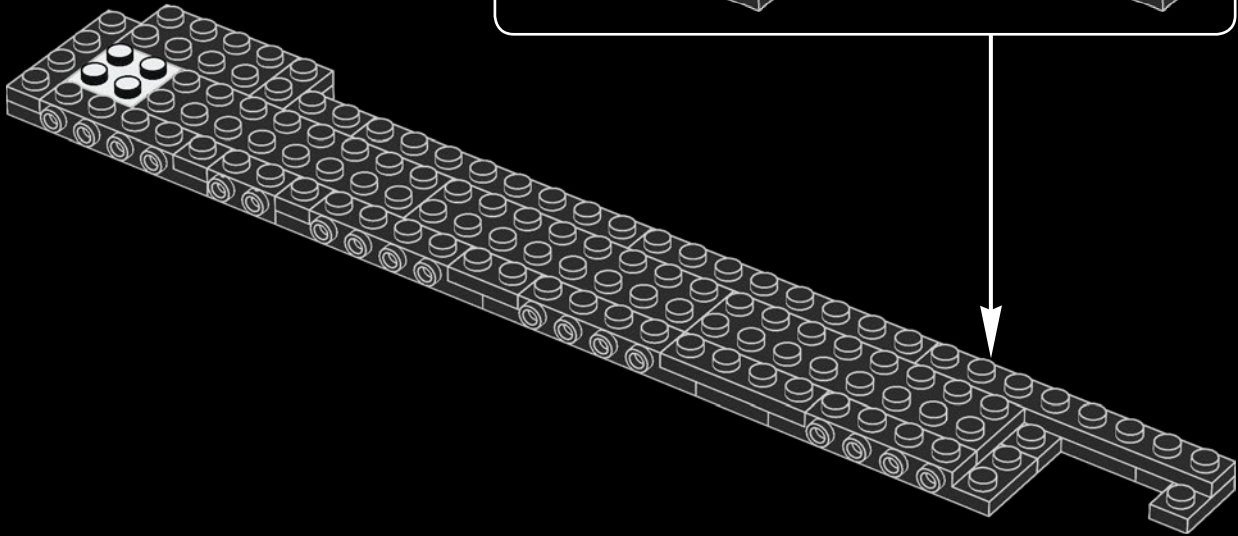
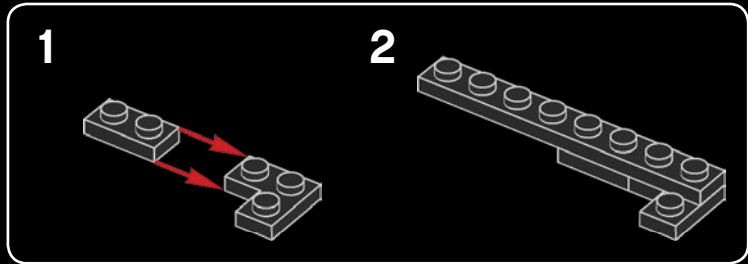



1x

19

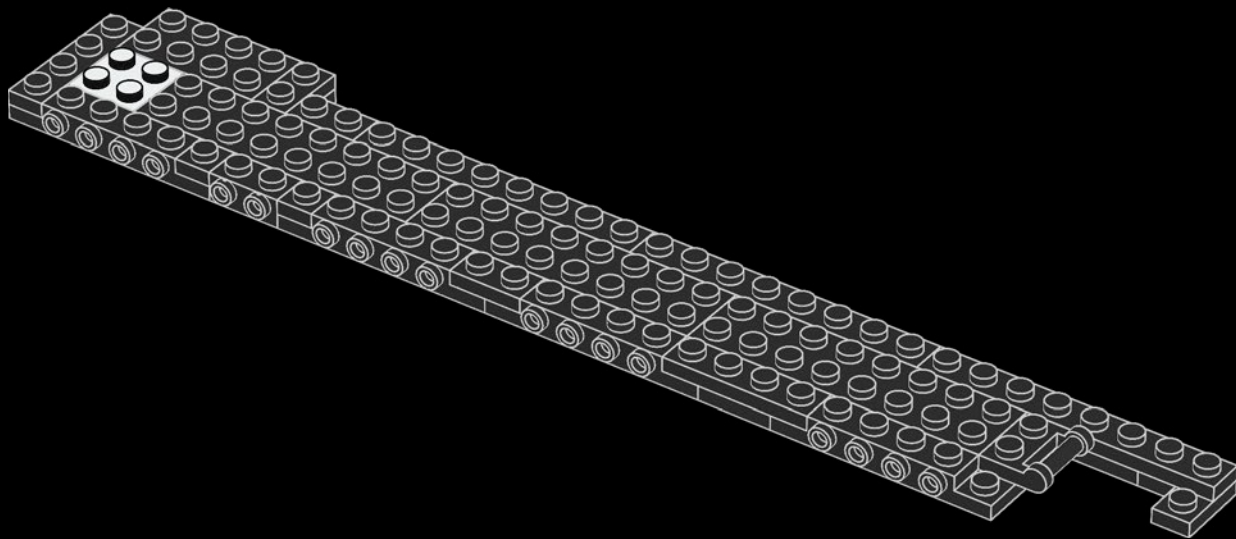

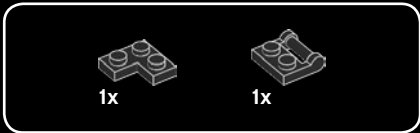

20

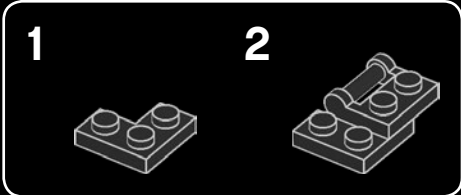
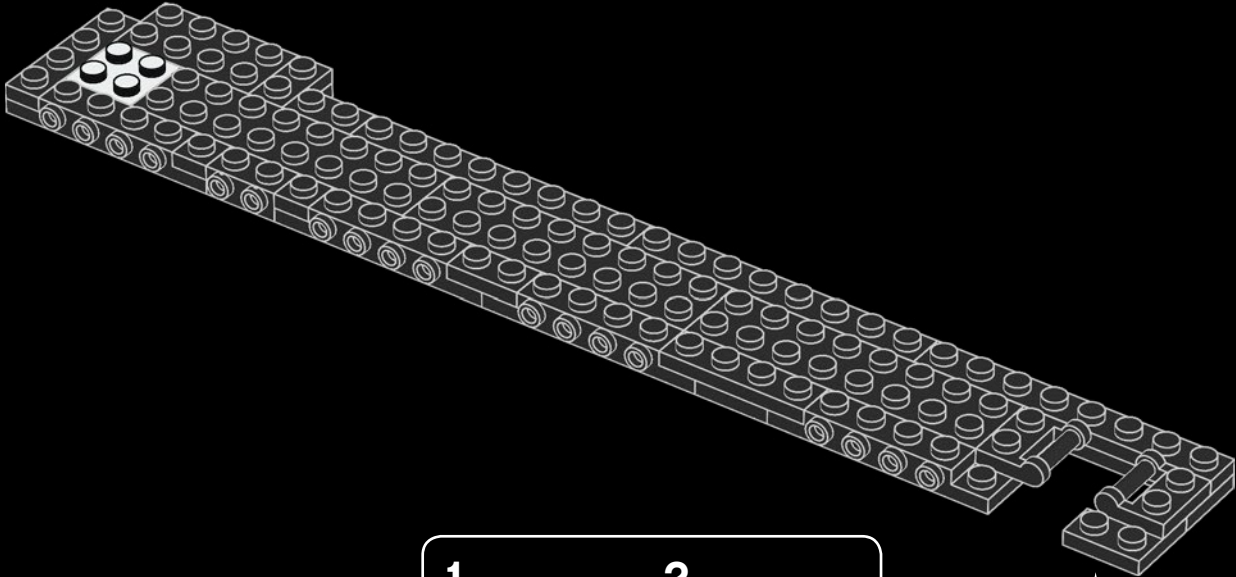



21

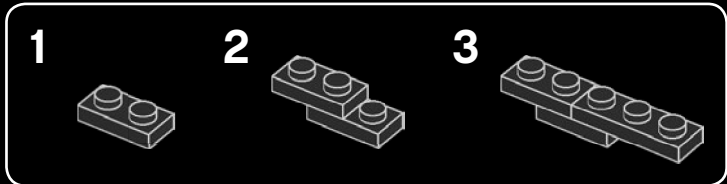
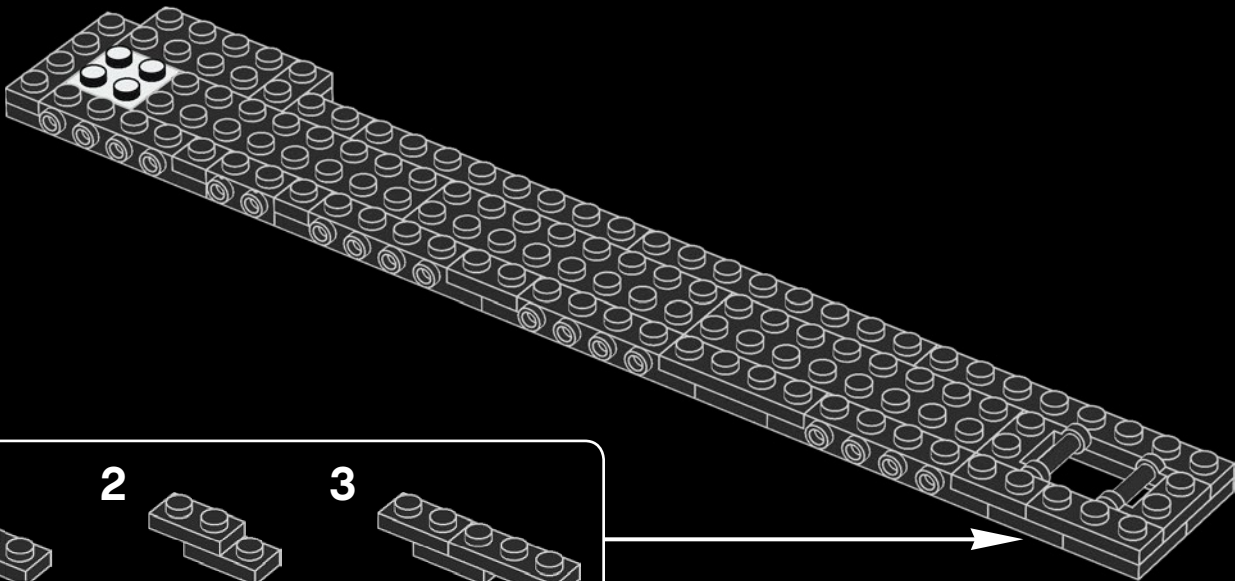

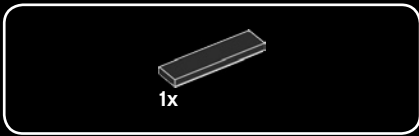

22

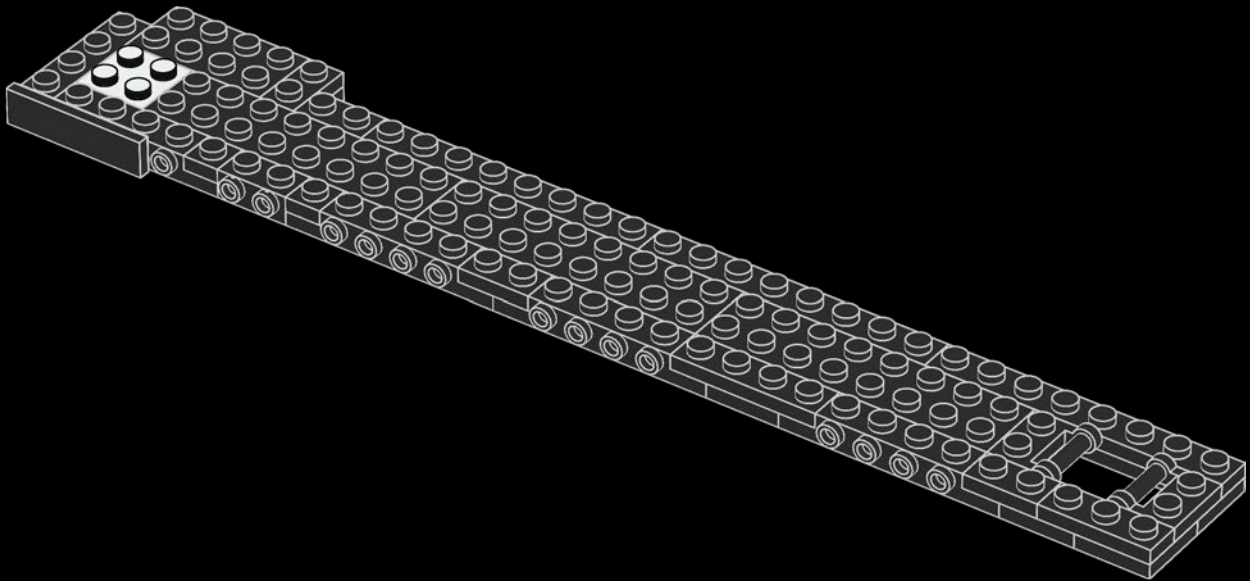

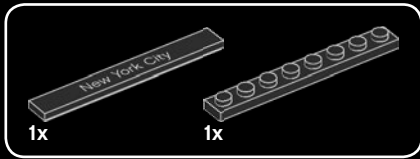

23

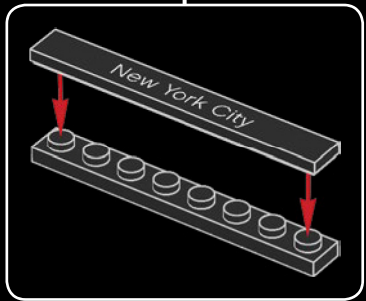
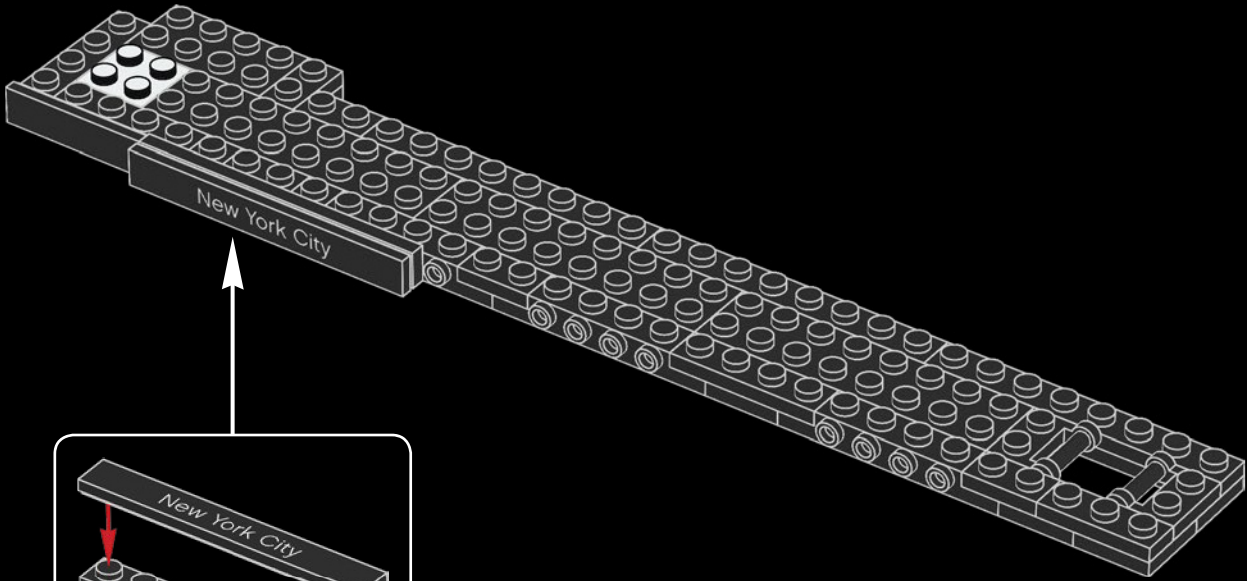

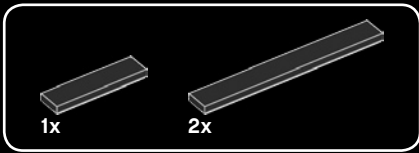

24

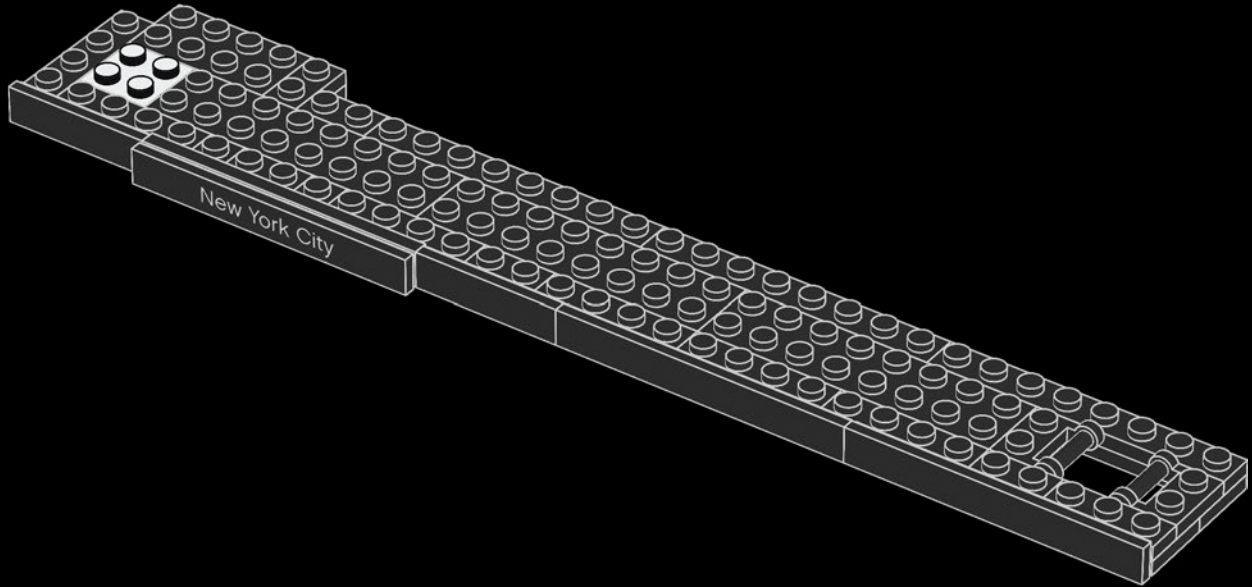



2x

25

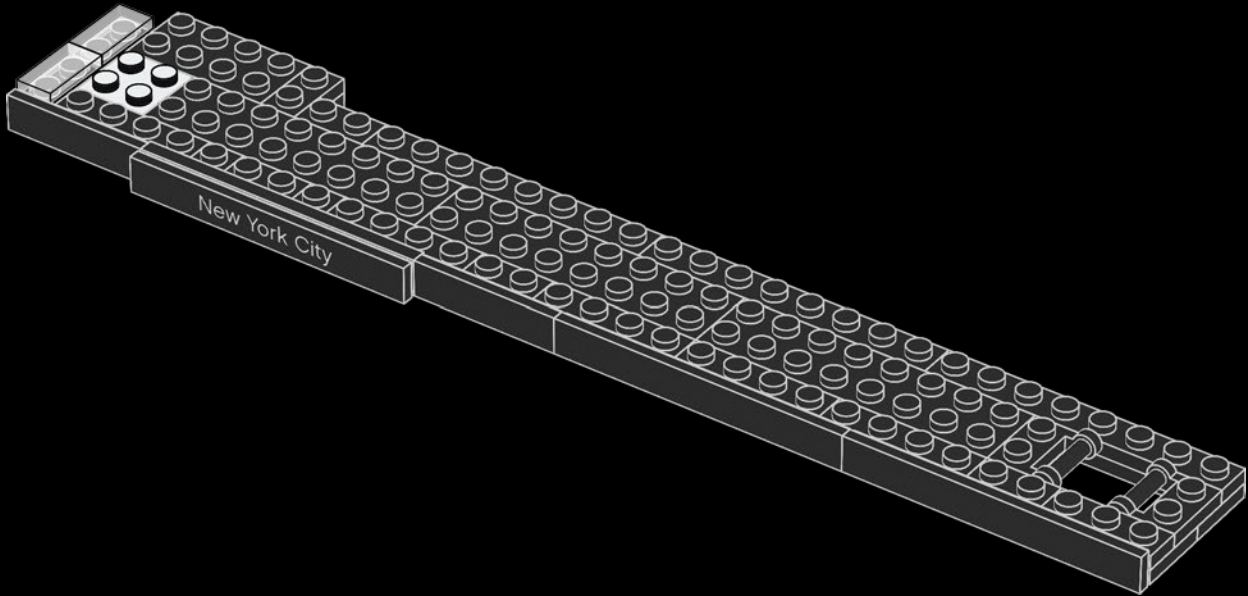

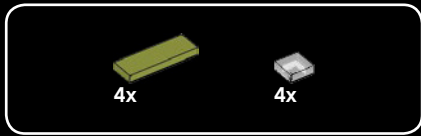

26

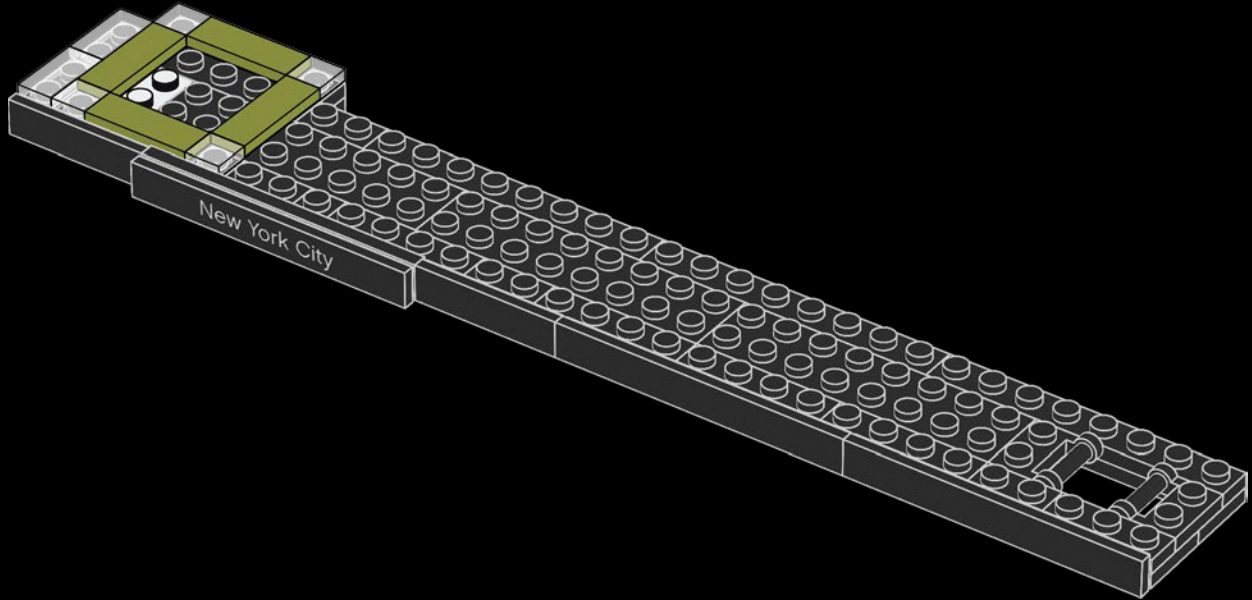



4x

27

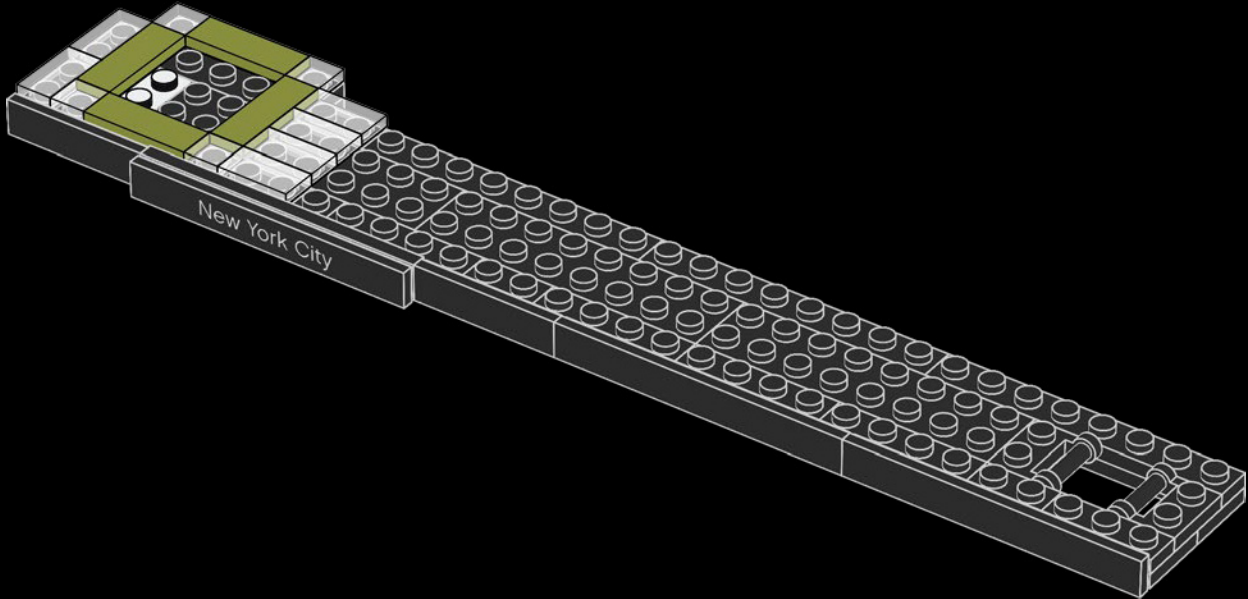

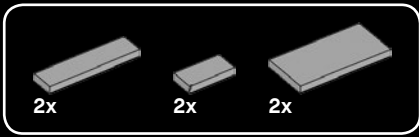

28

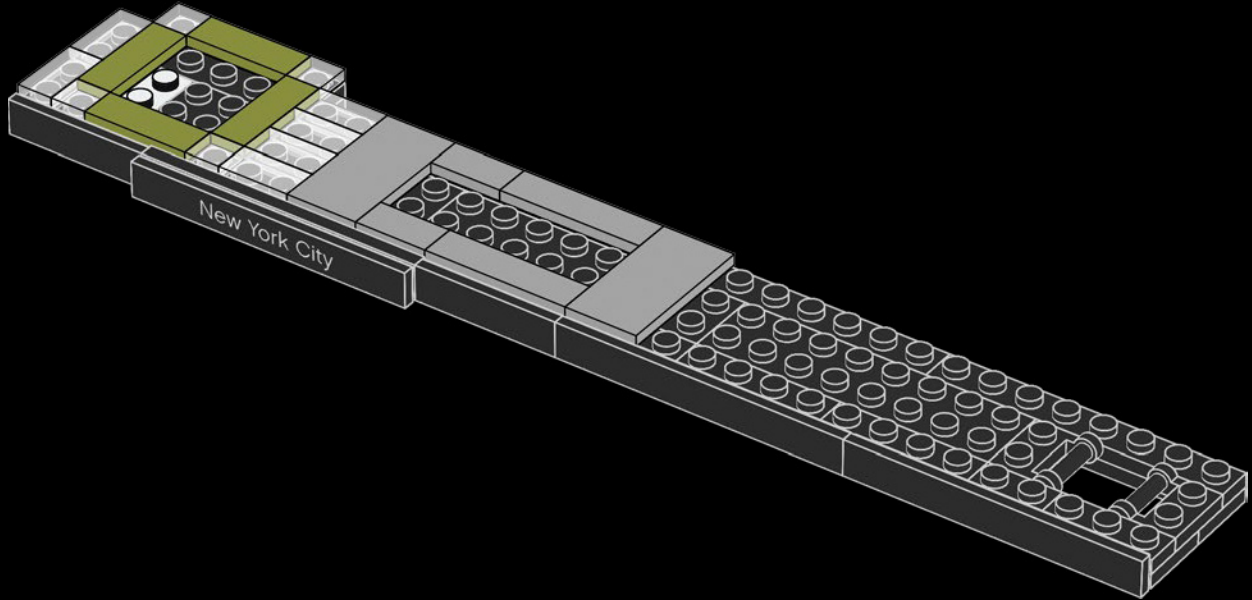

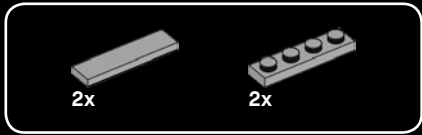

29

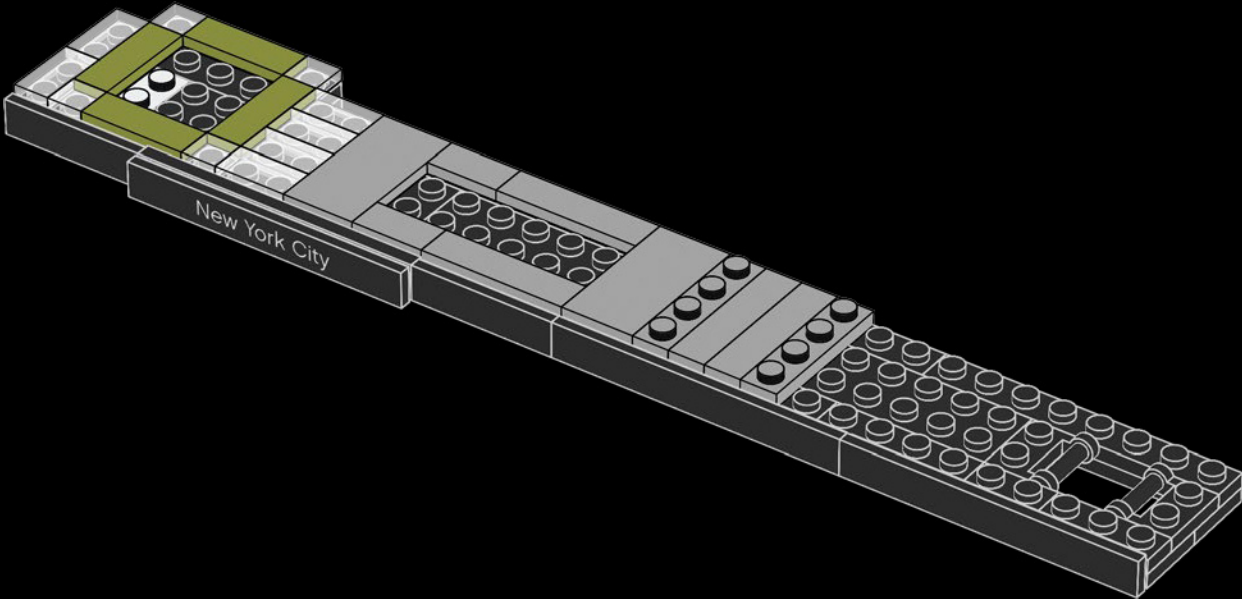

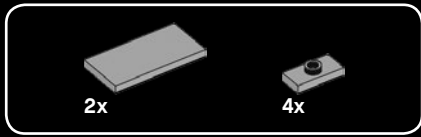

30

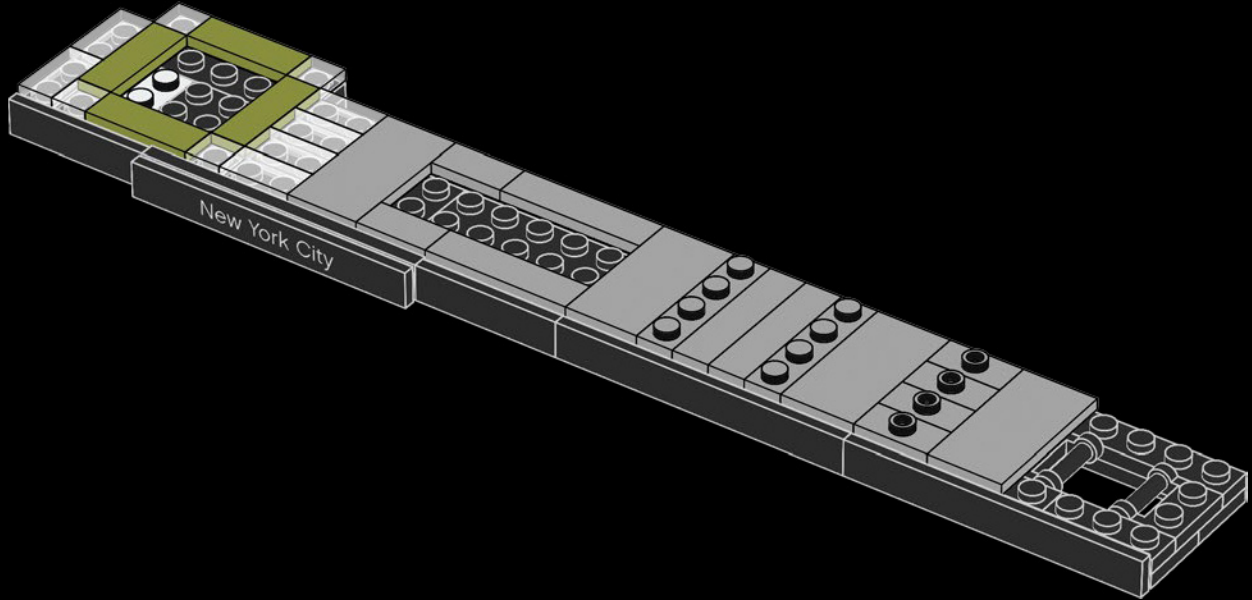



2x



2x

31

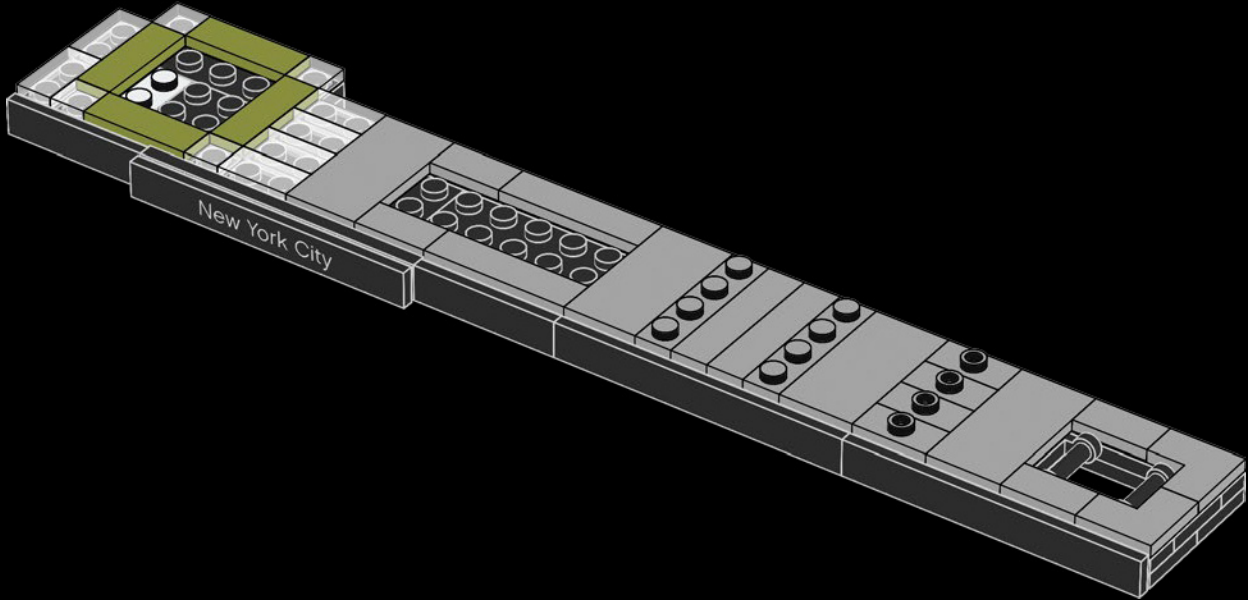

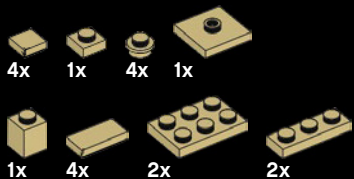

32

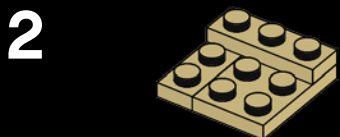
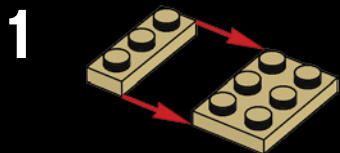

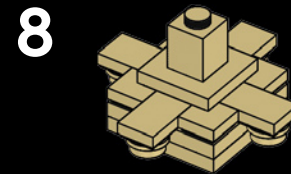
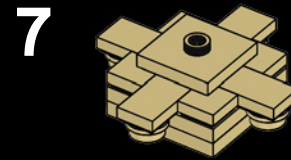
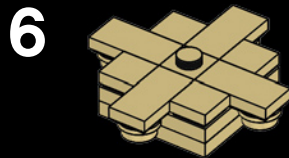
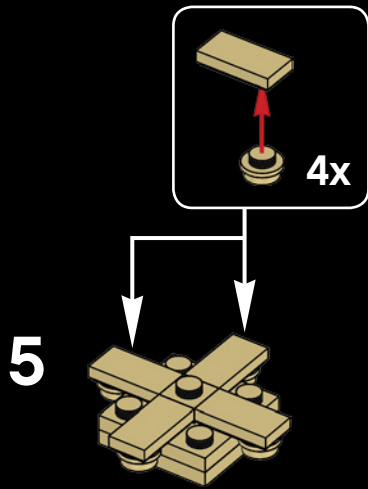

Maintained by the National Park Service since 1933, the Statue of Liberty is visited by around 4 million people every year.



© Victor Maschek

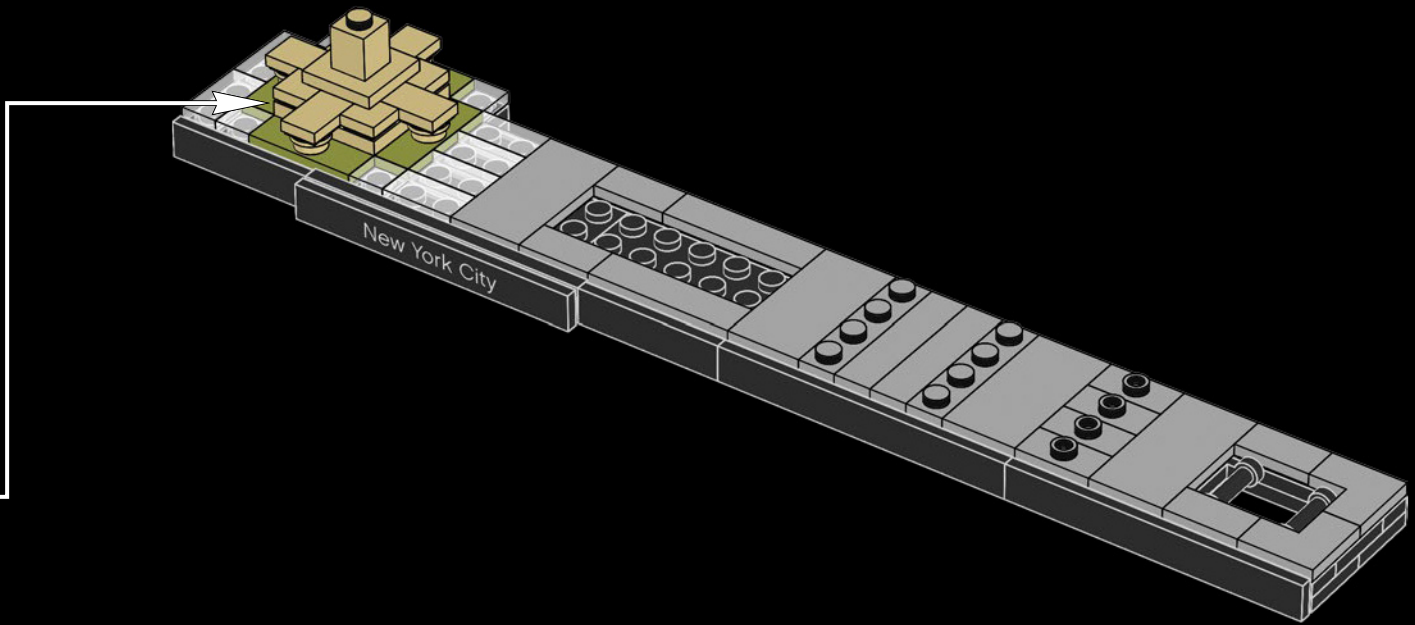



1x



1x

33

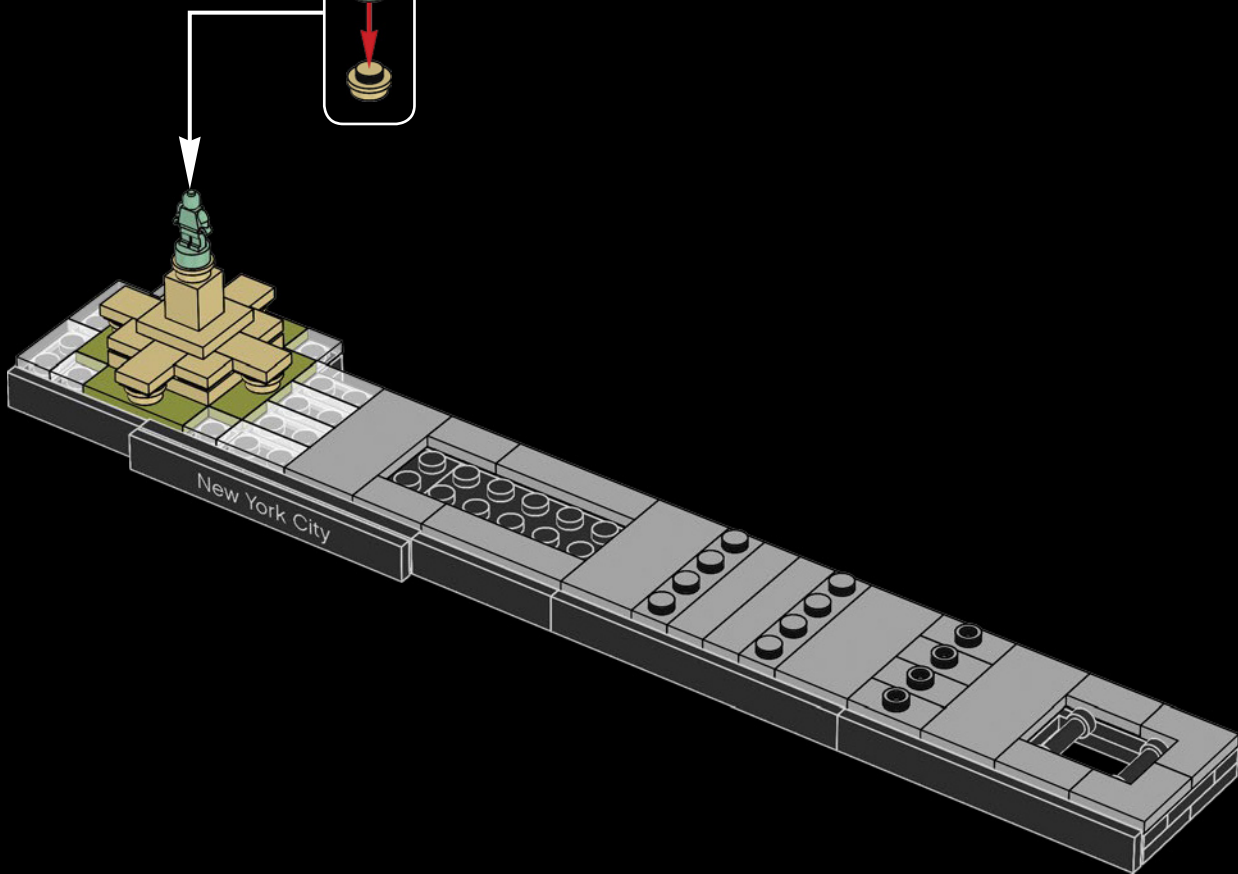
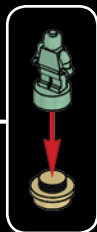

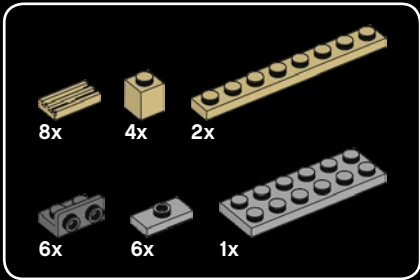
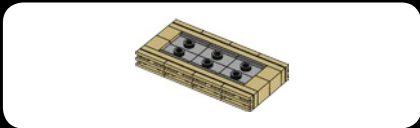

34

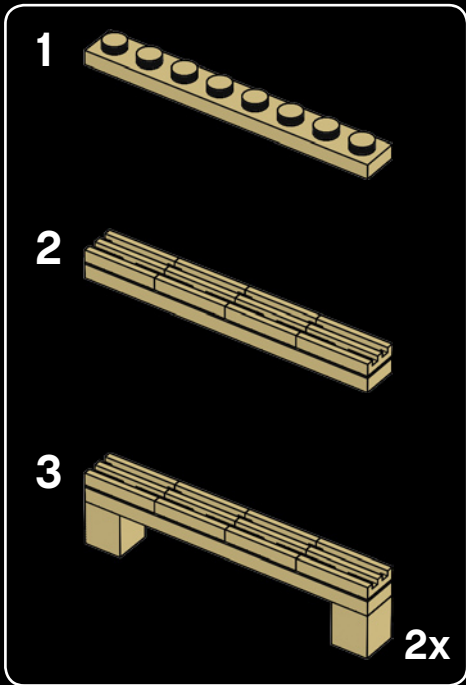

1

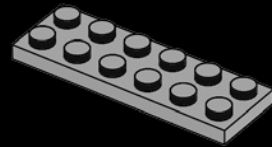

2

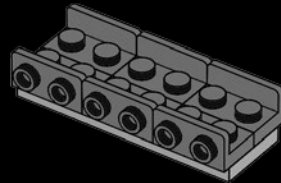

3

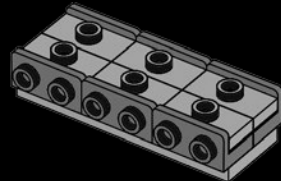

4

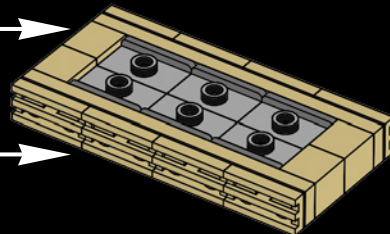

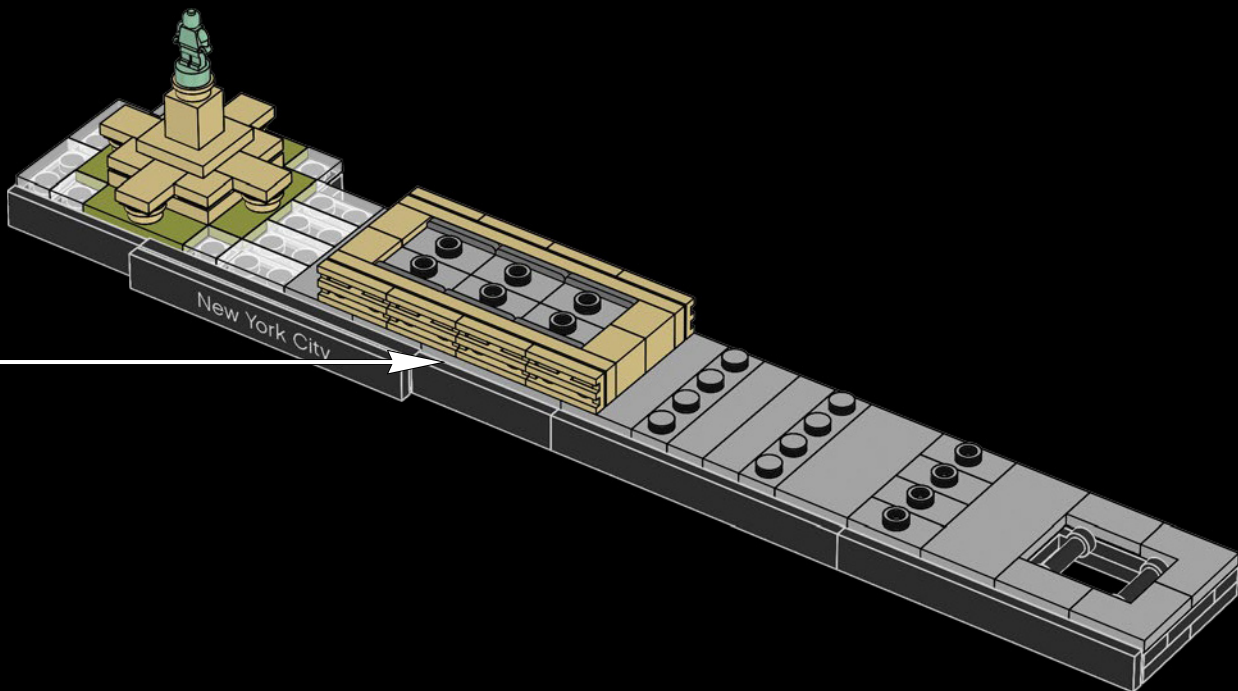

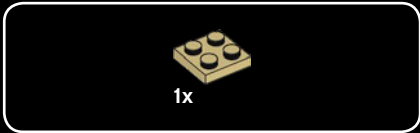

1

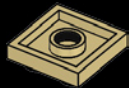

2

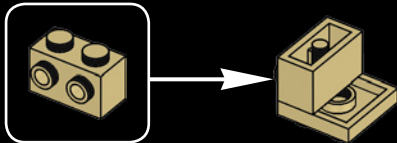

3

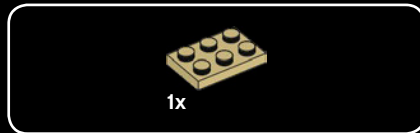

4

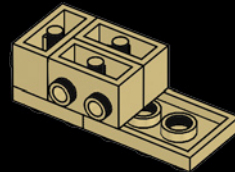



2x

5

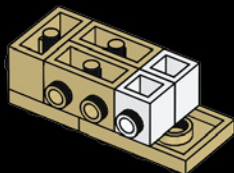

1x

6

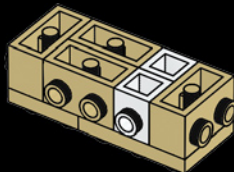

1x



1x

7

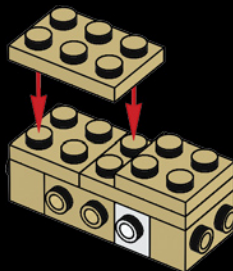

1x

8

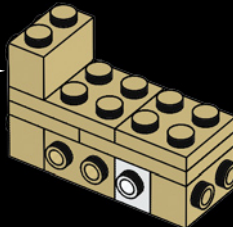



9

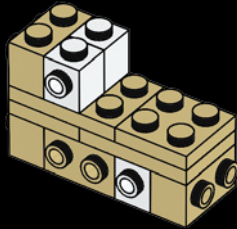

10

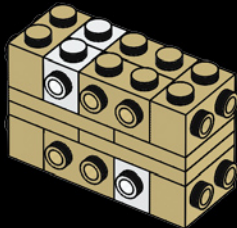

11

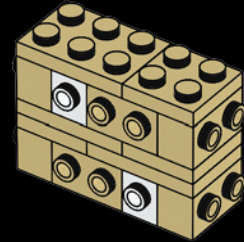

12

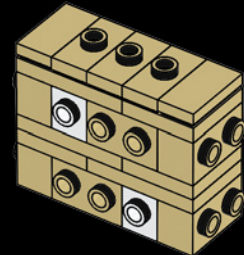

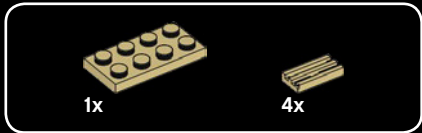

13

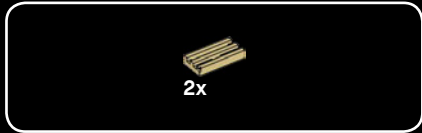
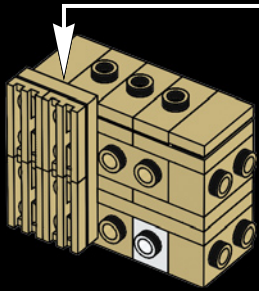
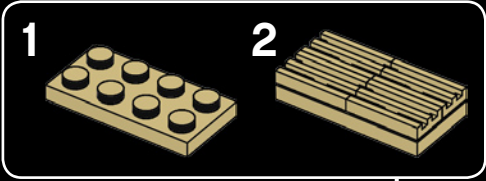

14

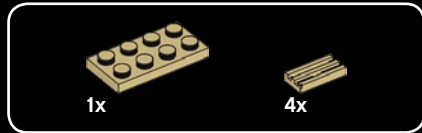
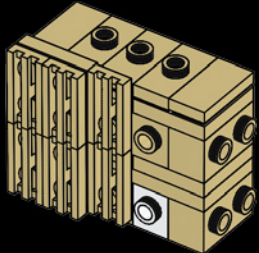

15

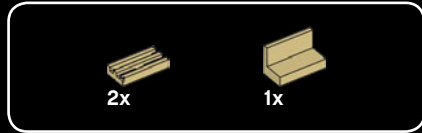
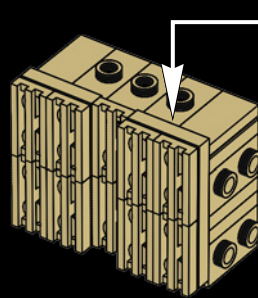
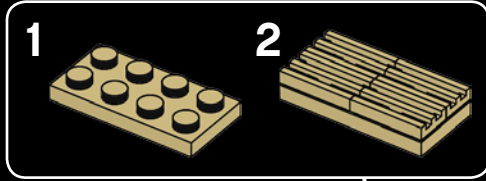

16

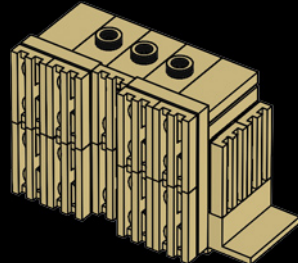

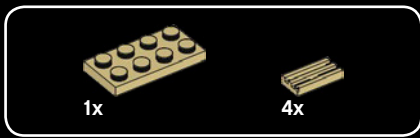

17

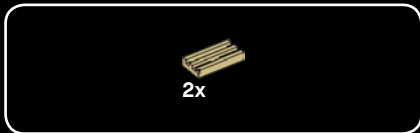
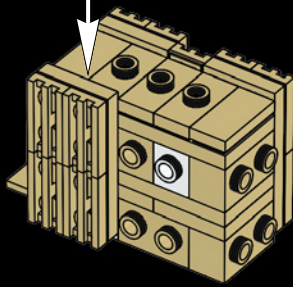
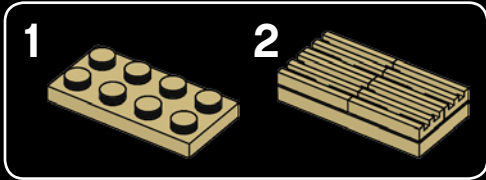

18

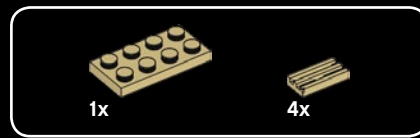
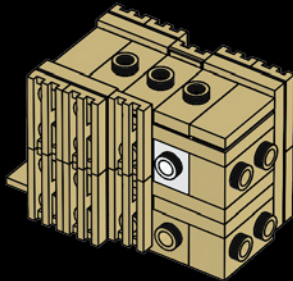

19

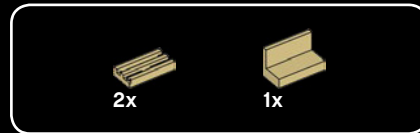
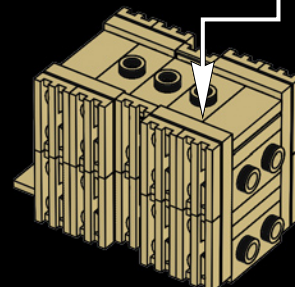
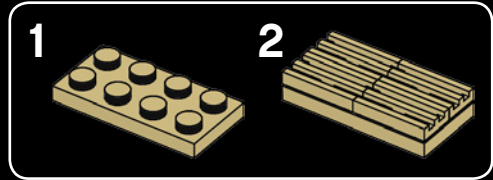

20

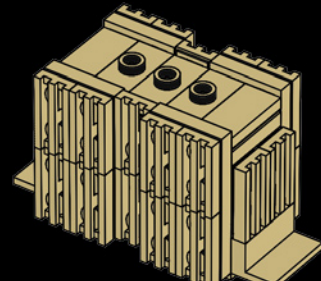



1x

21

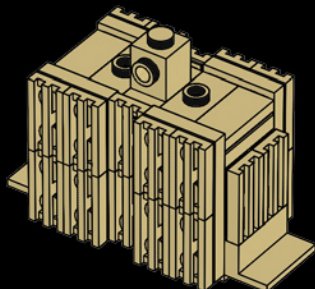

6x

22

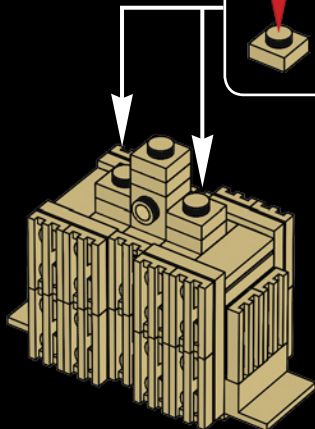

3x



2x

23

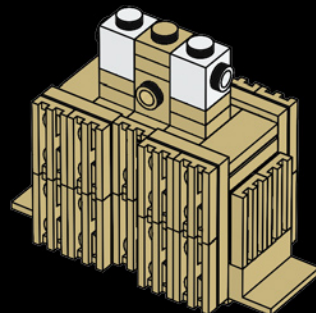

3x



1x

24

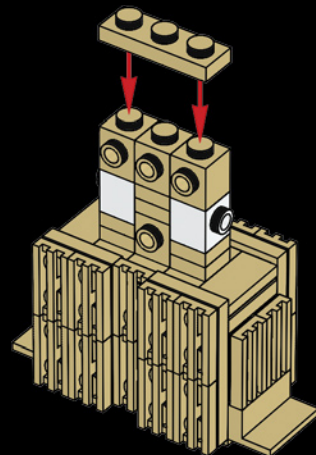

35

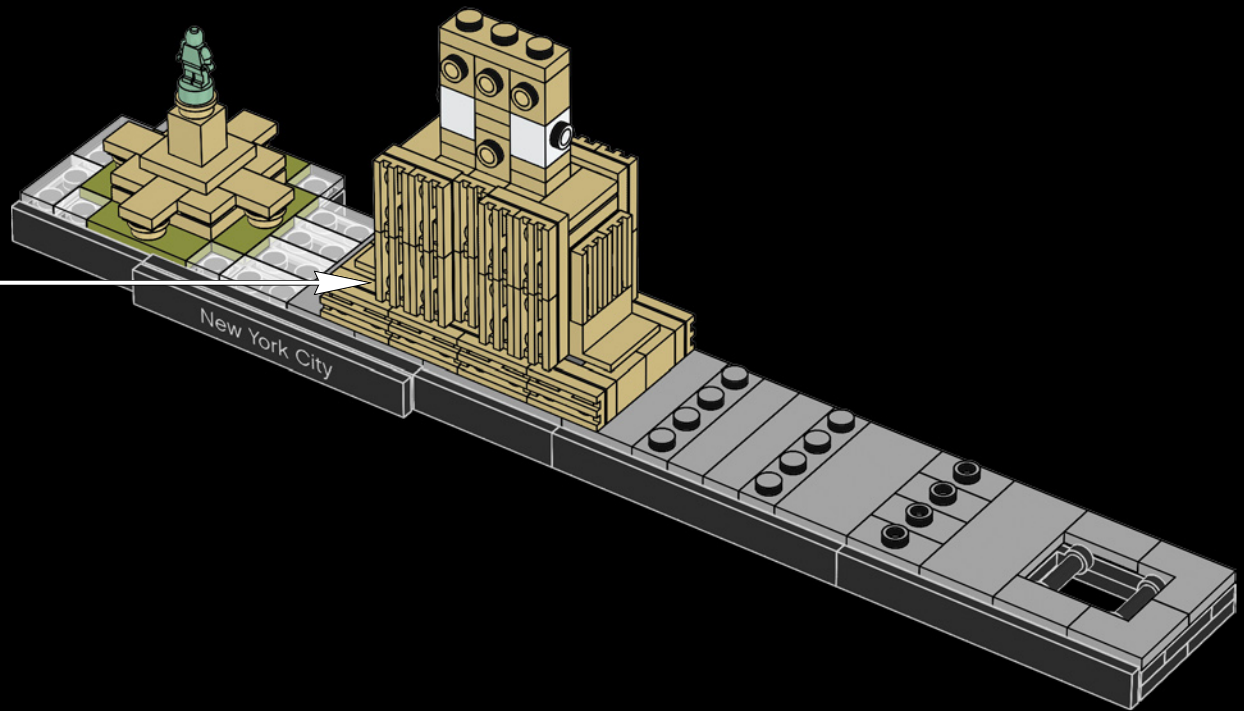

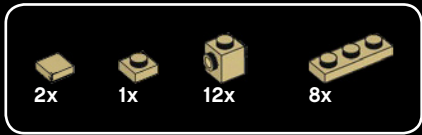

36

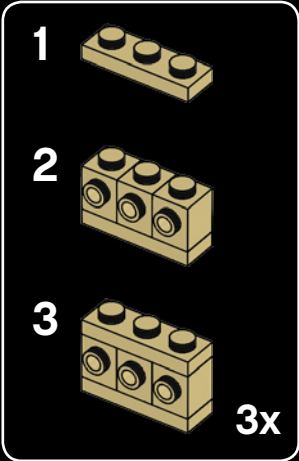

1



52

2

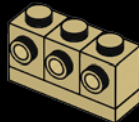

3

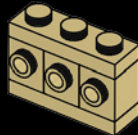

4



5



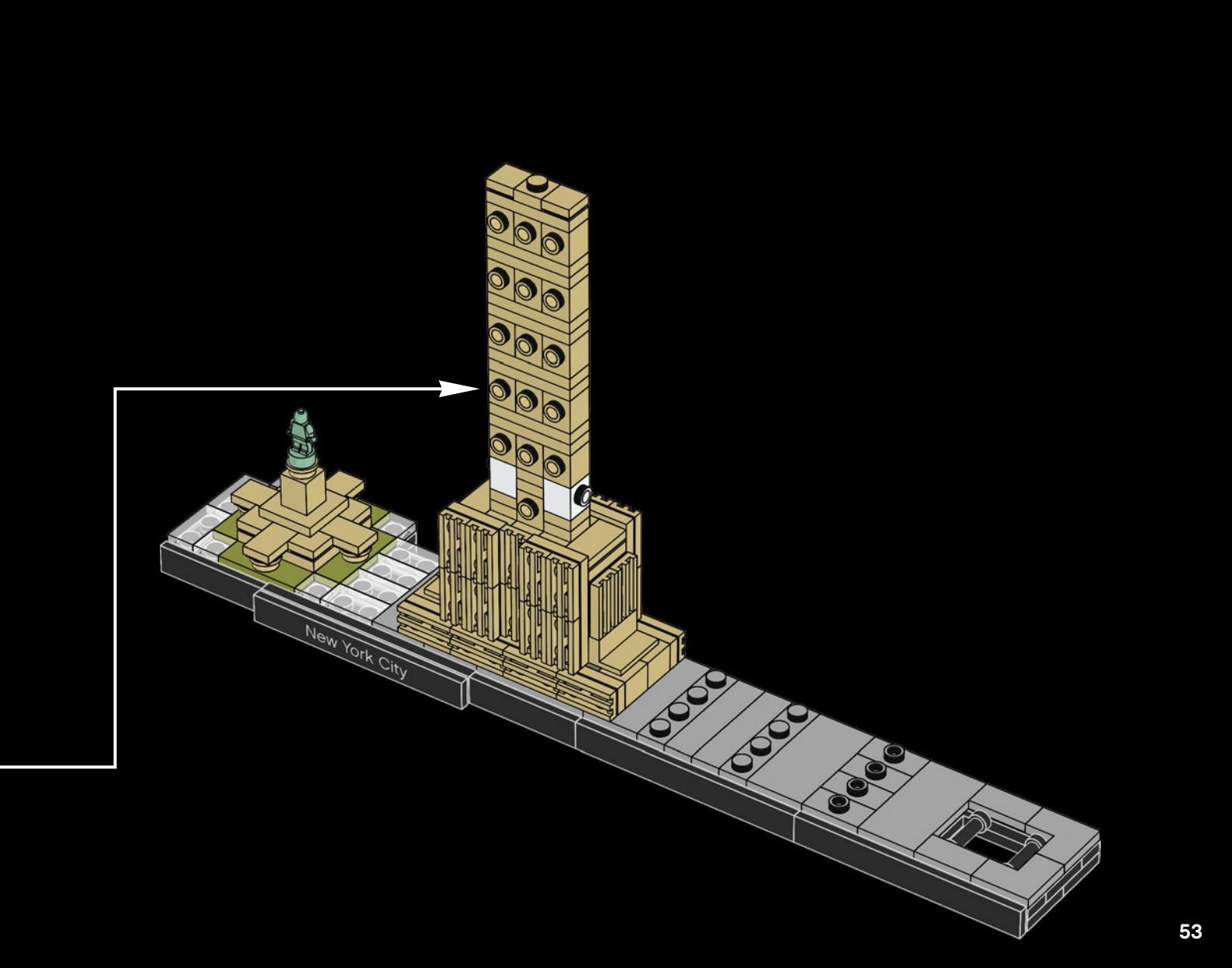

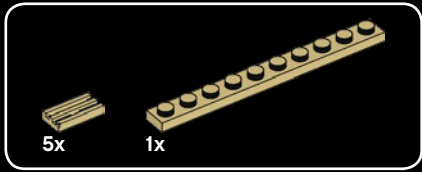

37

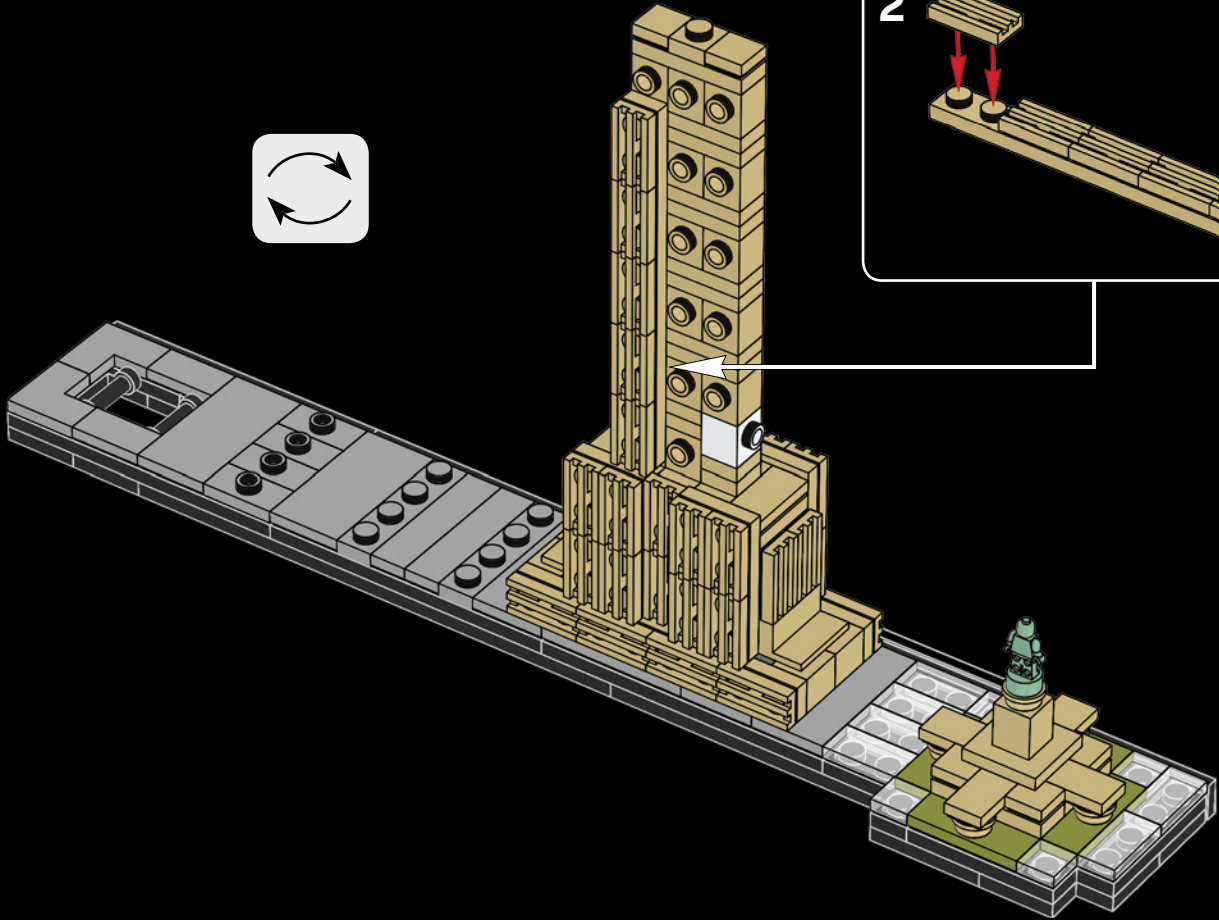
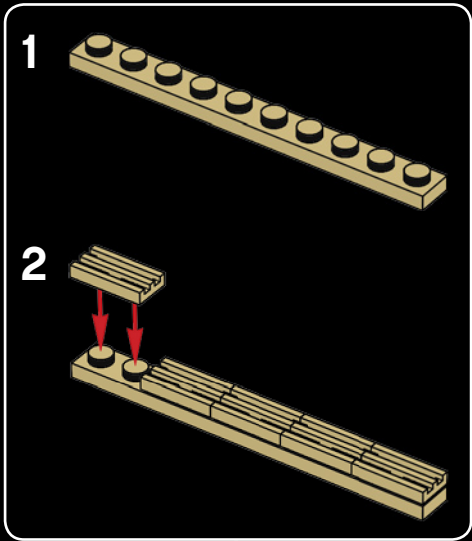

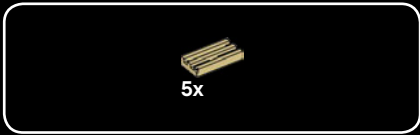

38

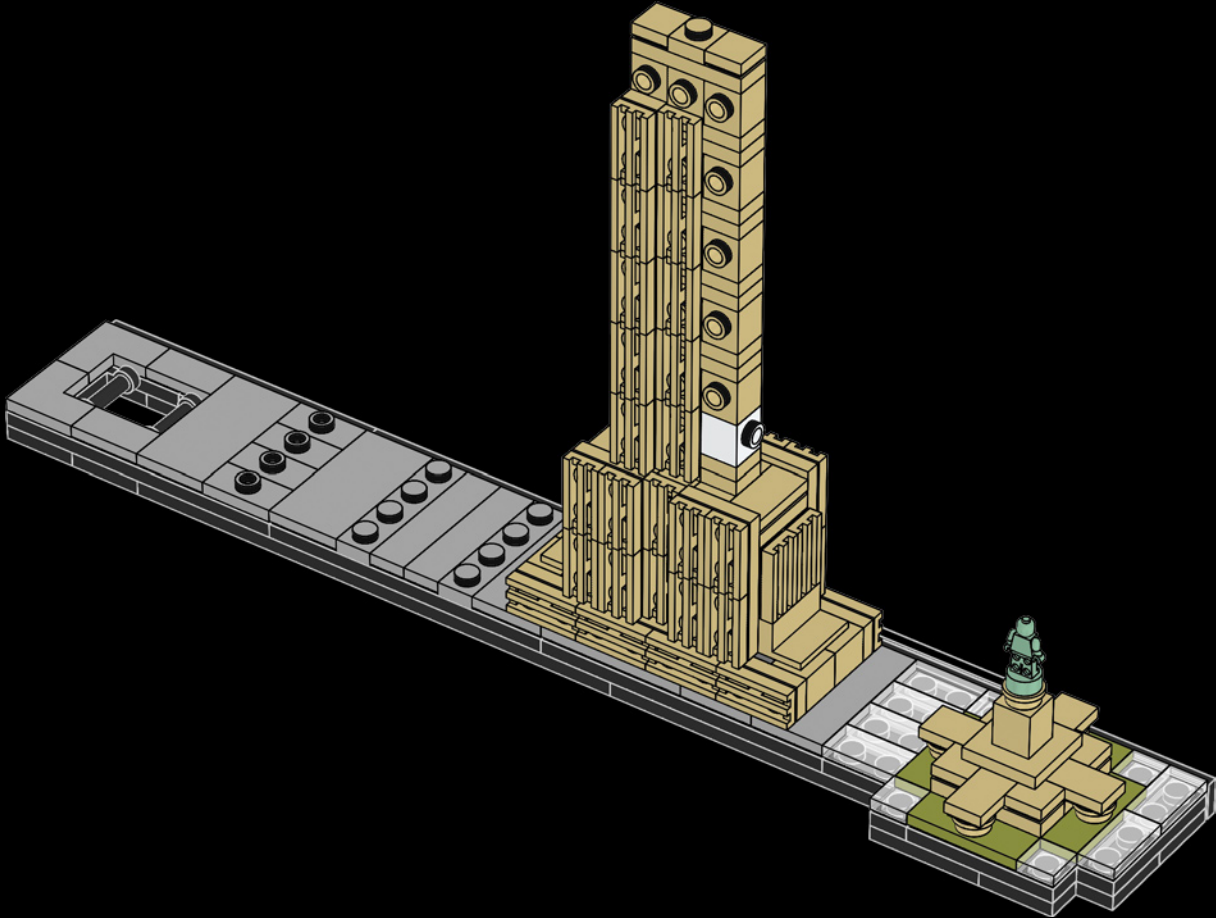

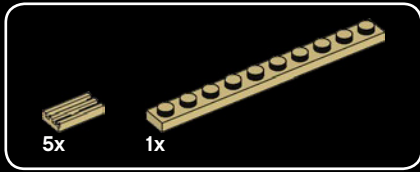

39

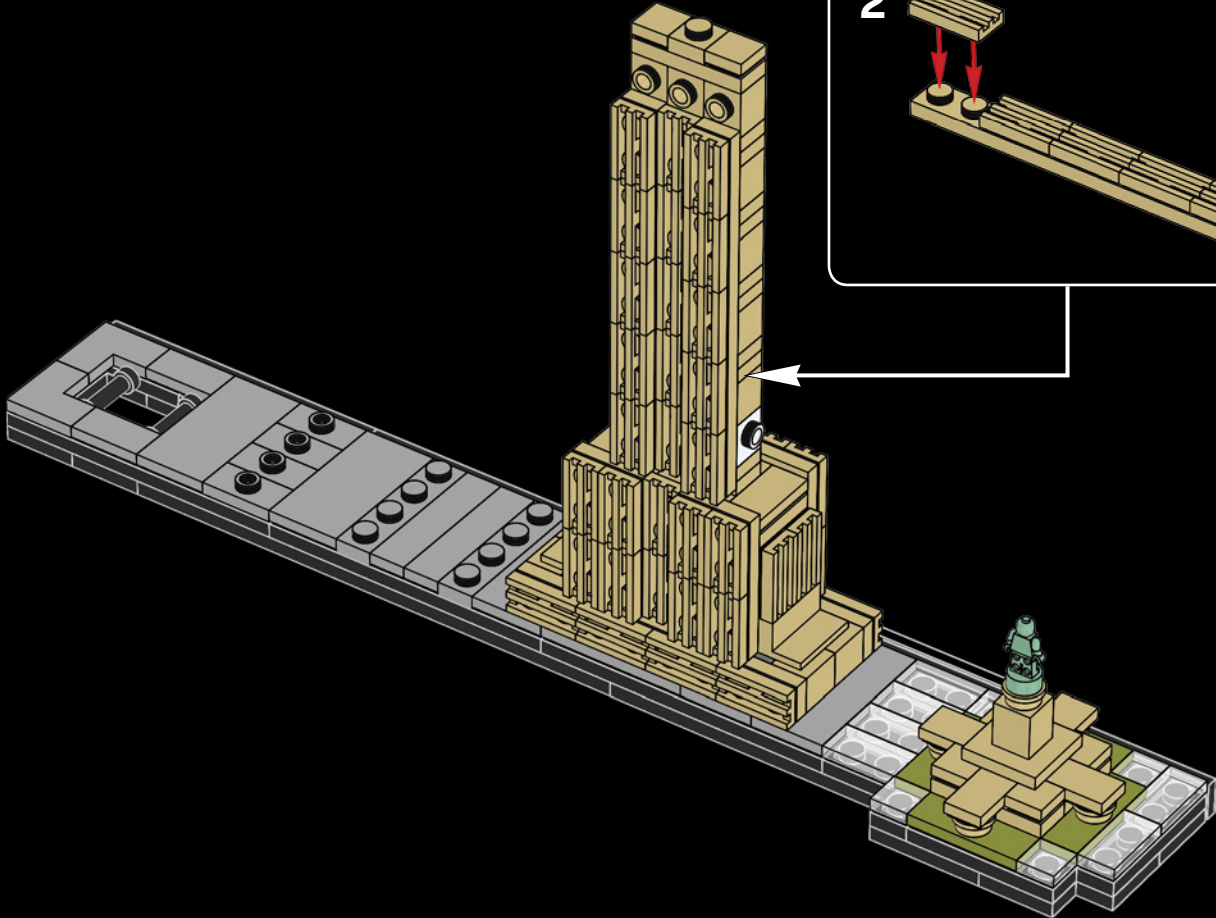
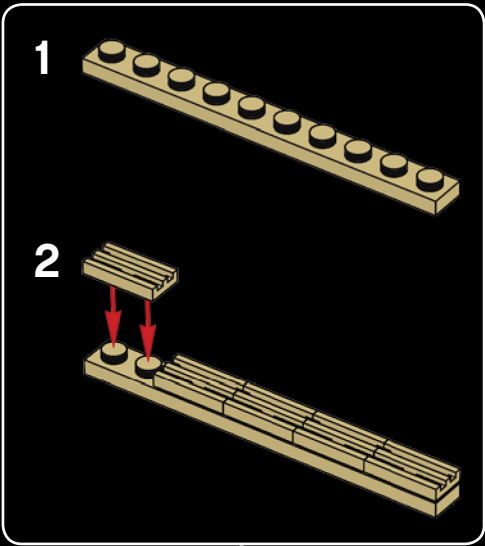

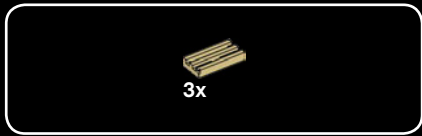

40

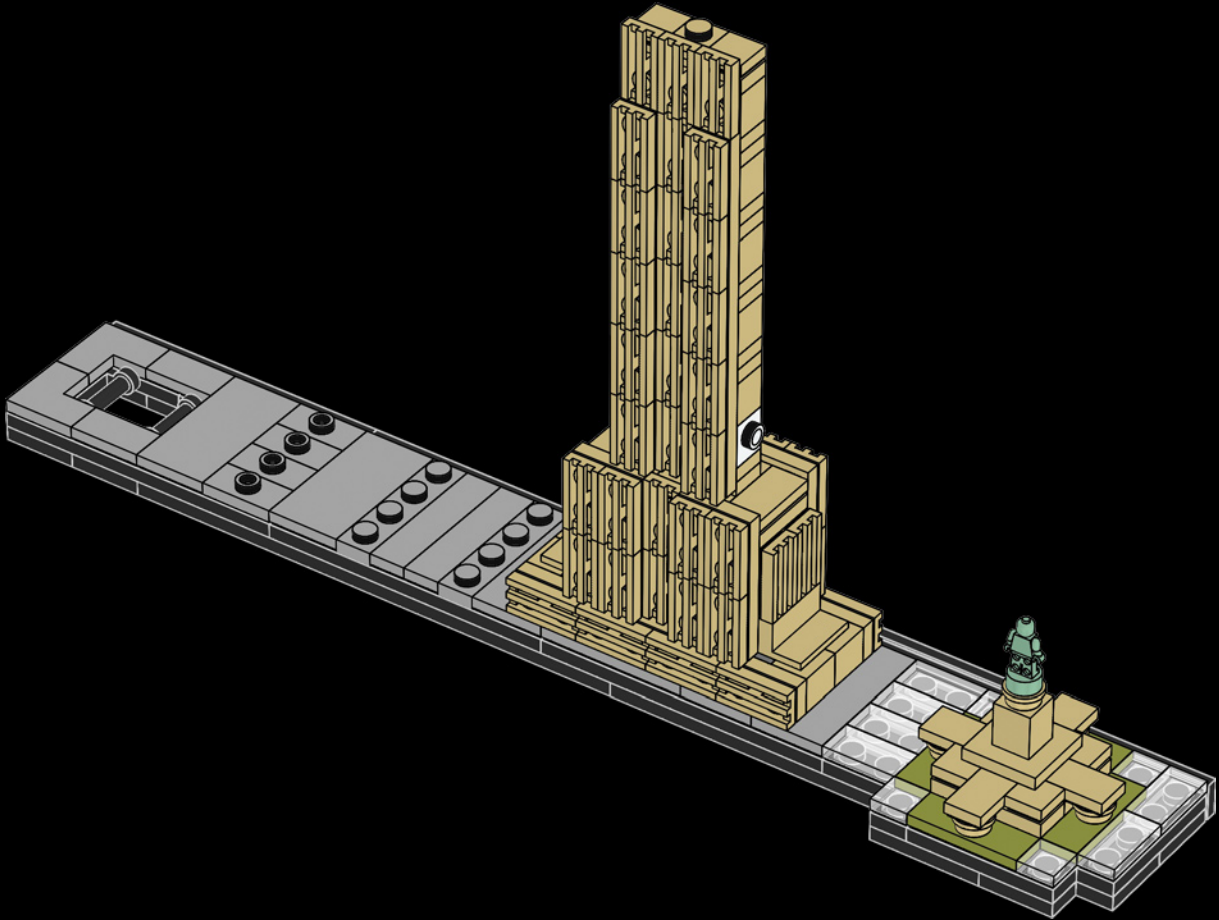

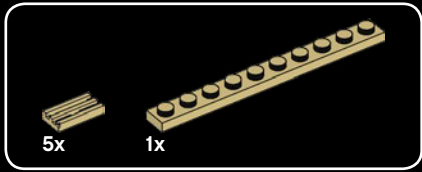

41

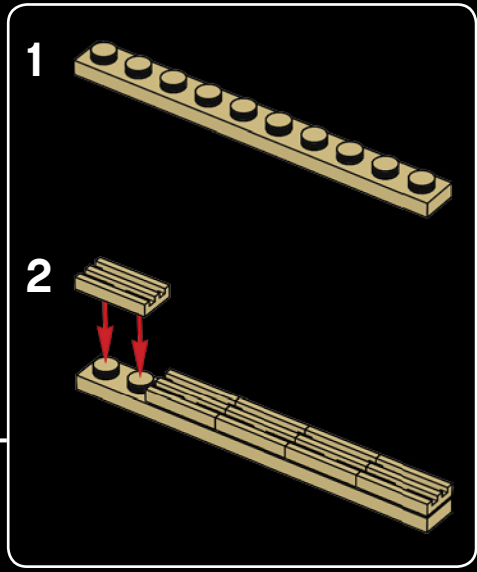
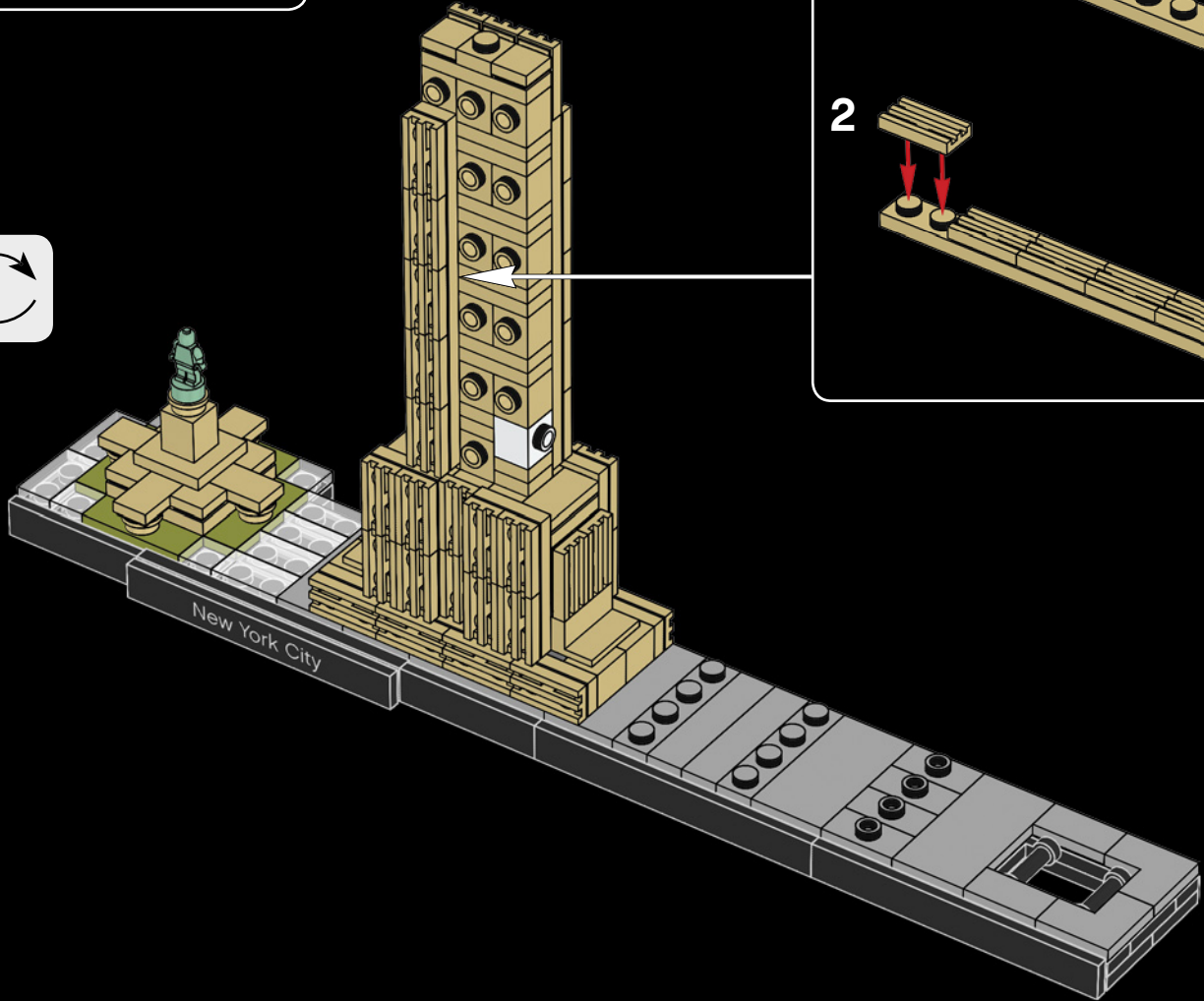

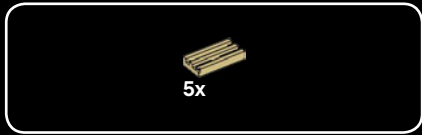

42

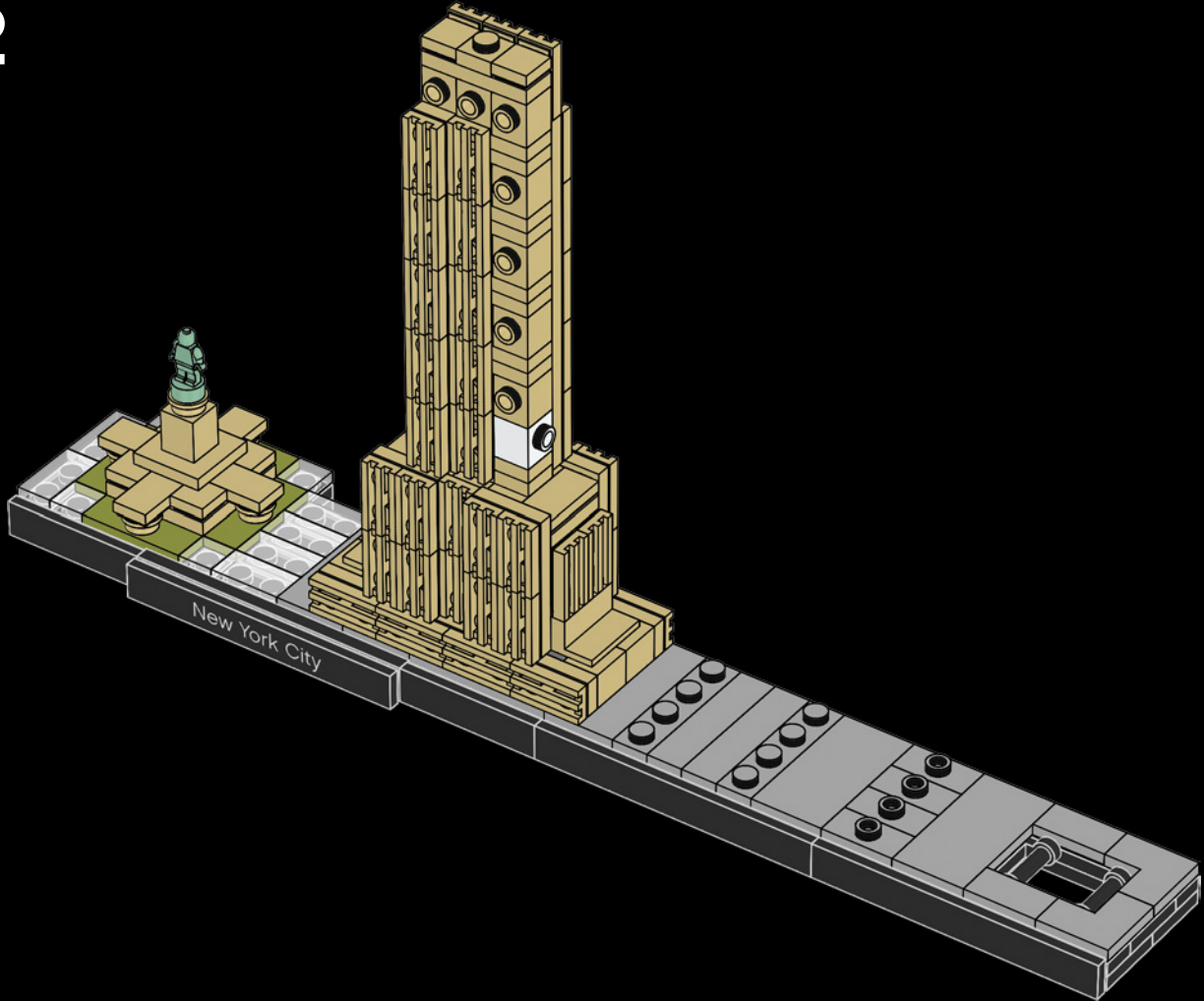

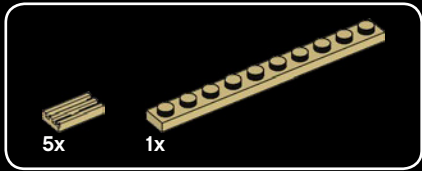

43

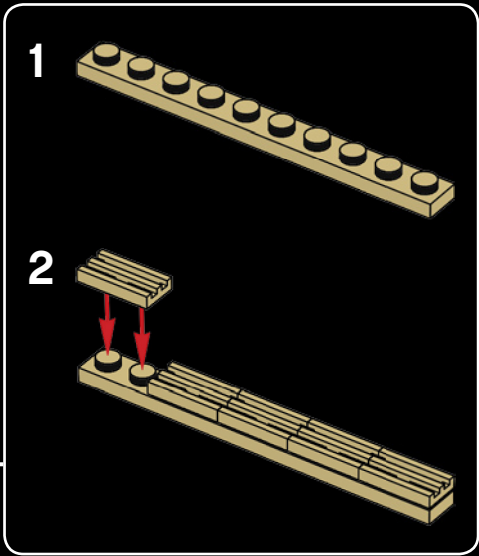
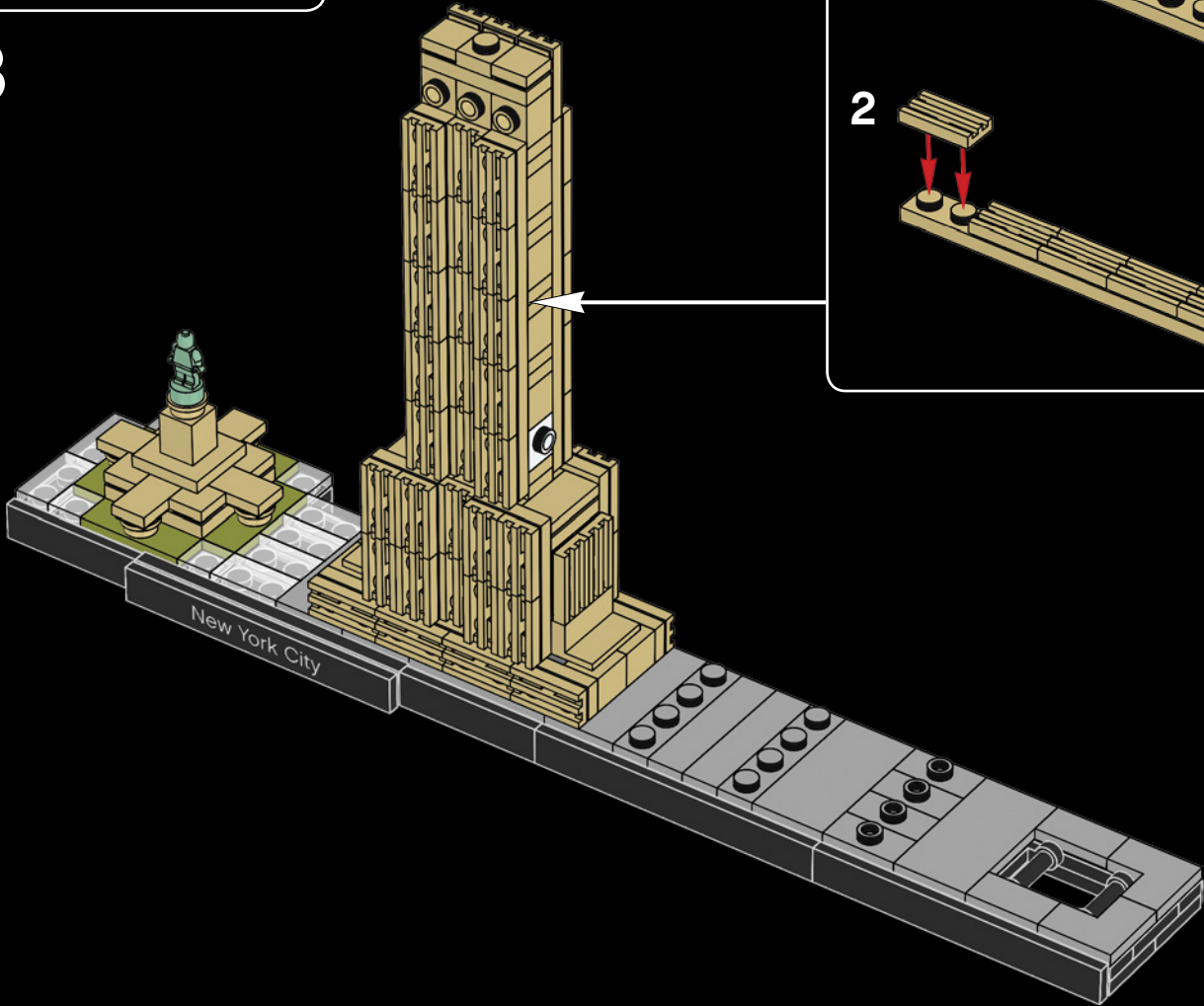



44

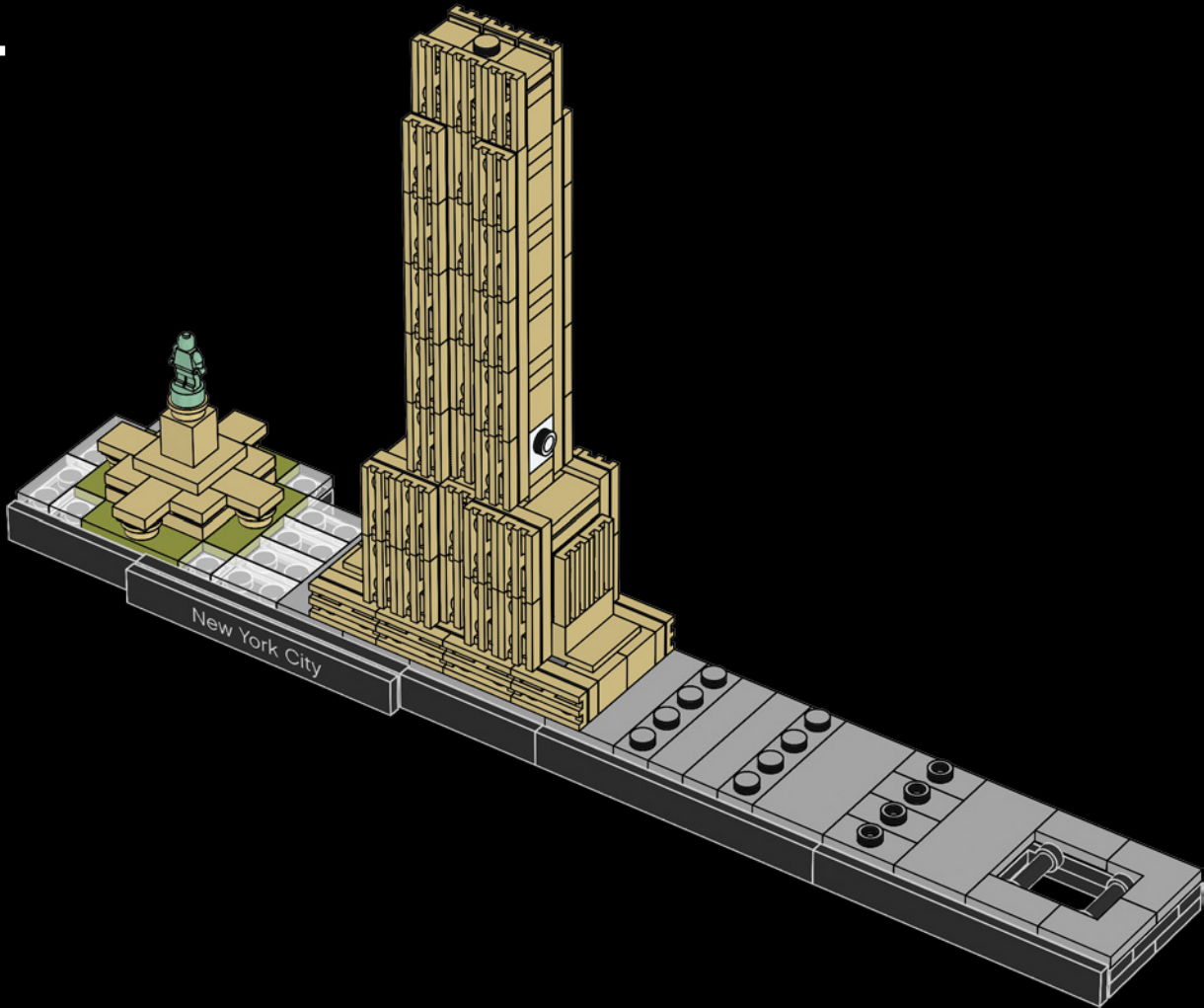

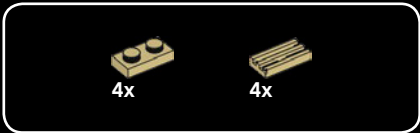

45

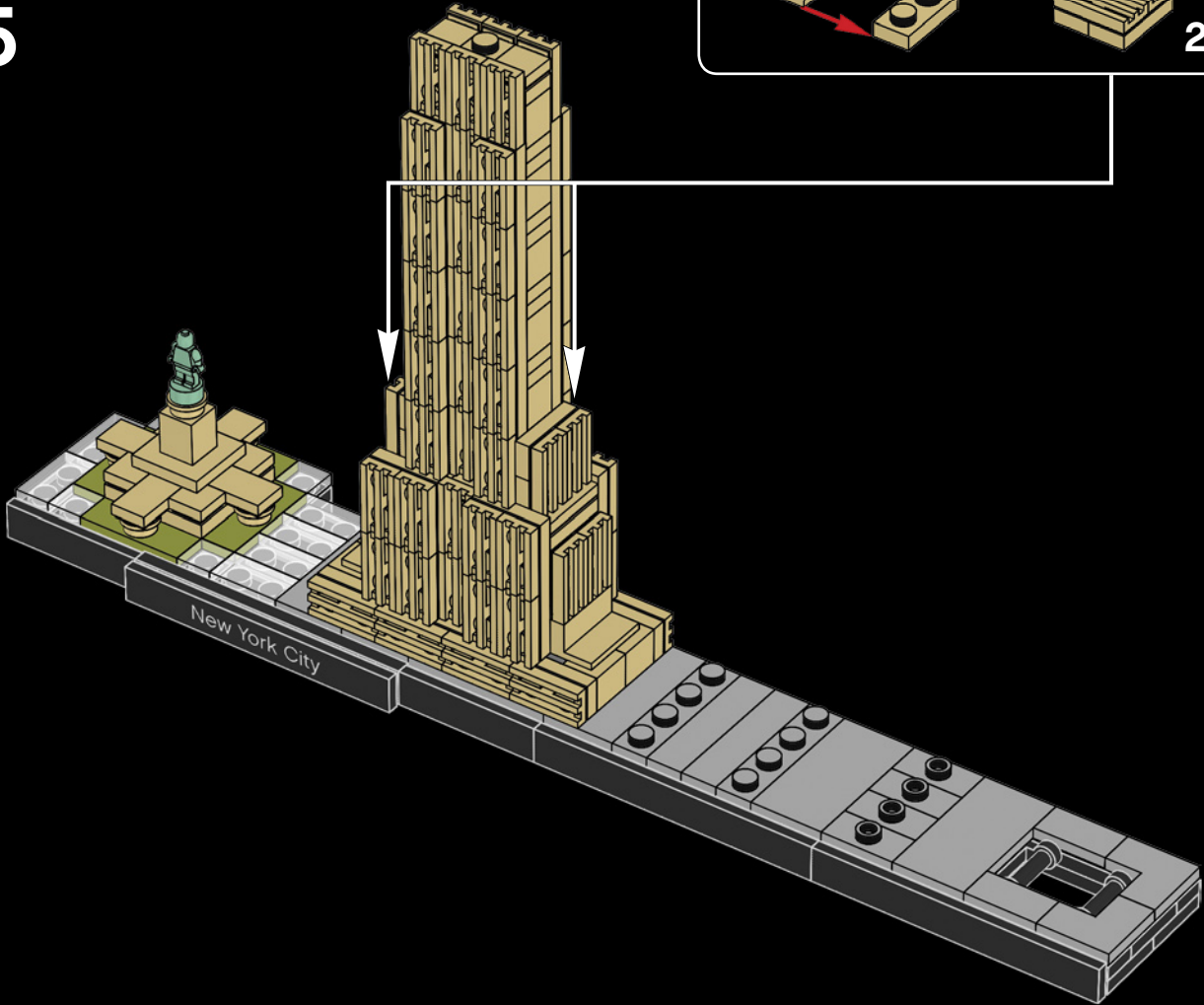
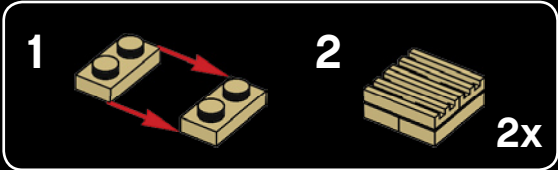



46

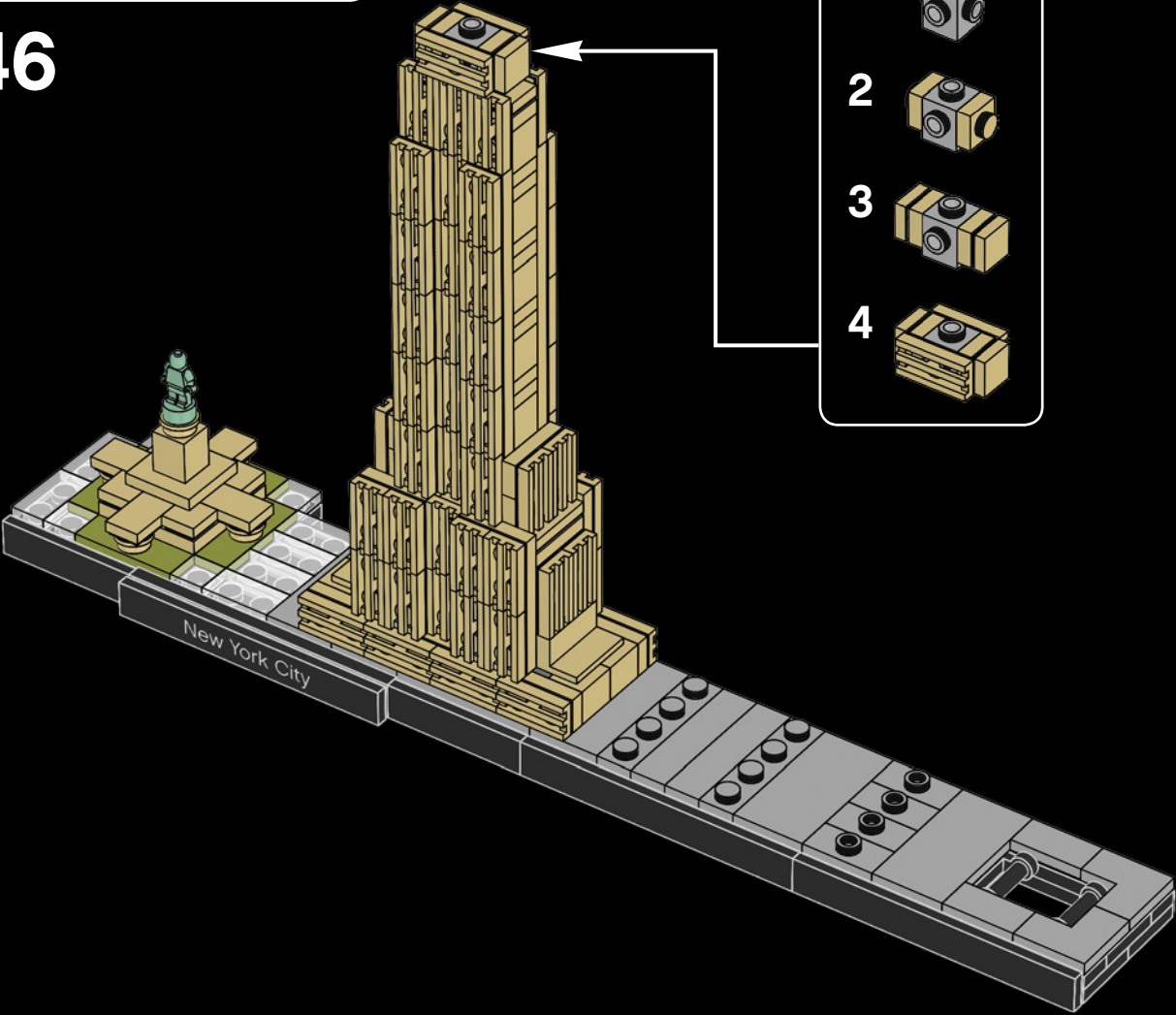

- 1
- 2
- 3
- 4



1x

47

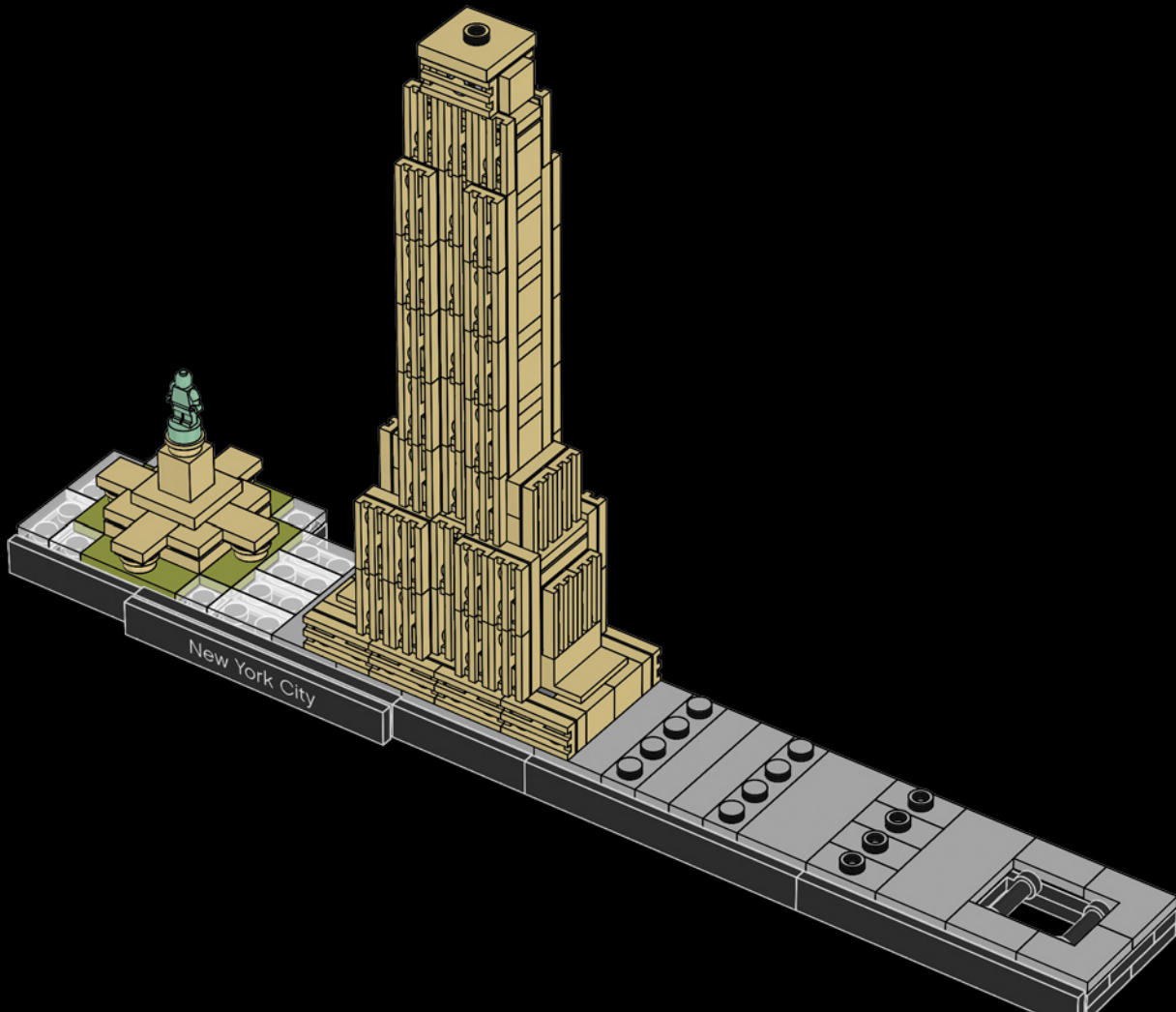

The Empire State Building has a lightning rod near the top which is struck by lightning around 23 times every year.



© Everett Historical

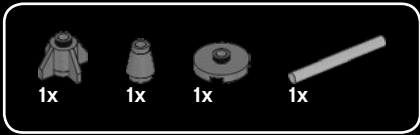

48

1



2



3

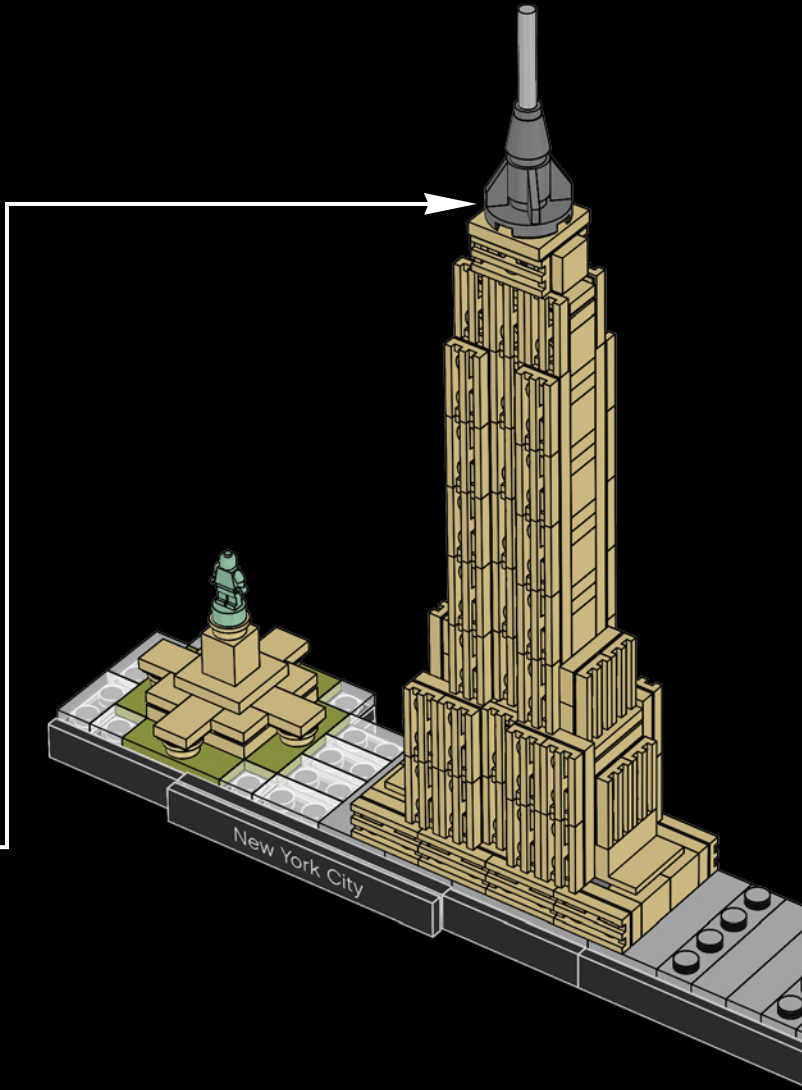
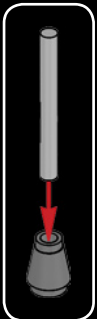
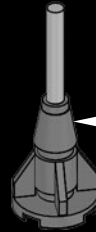



4x

49



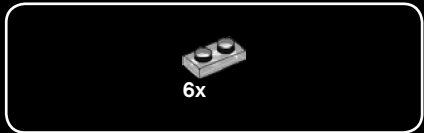

50

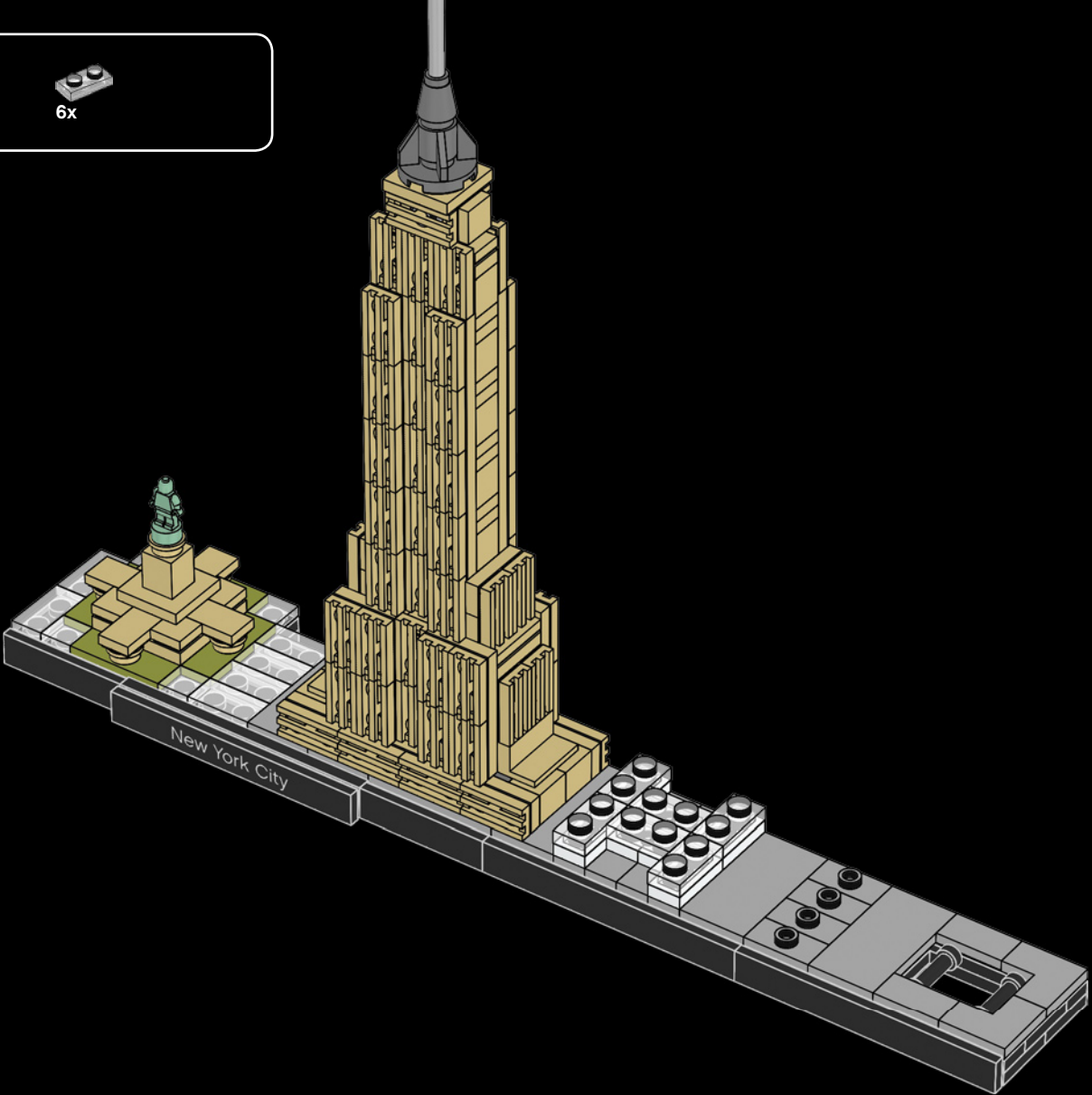

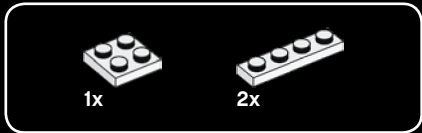

51

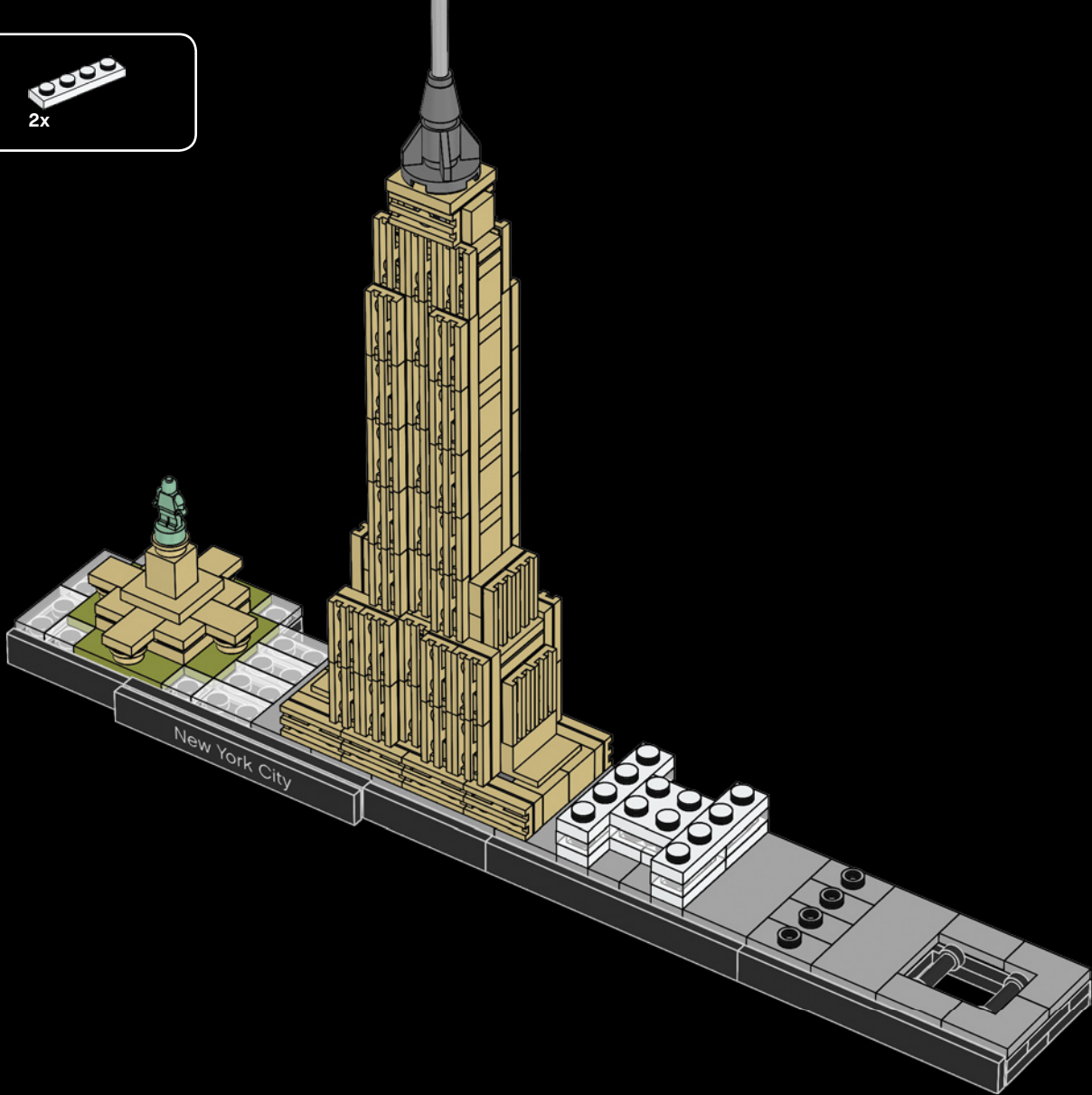

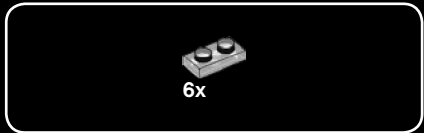

52

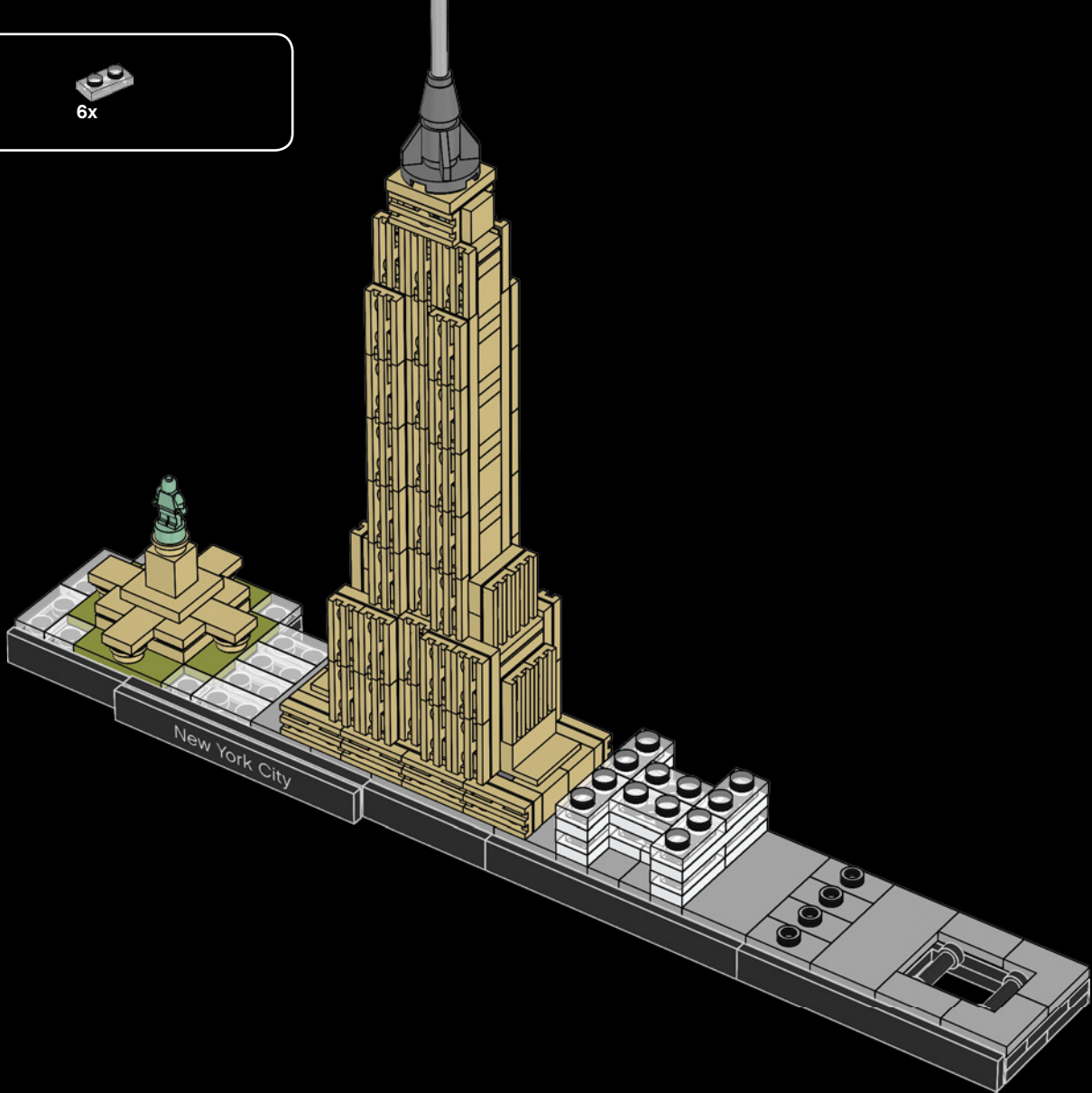



1x



4x

53

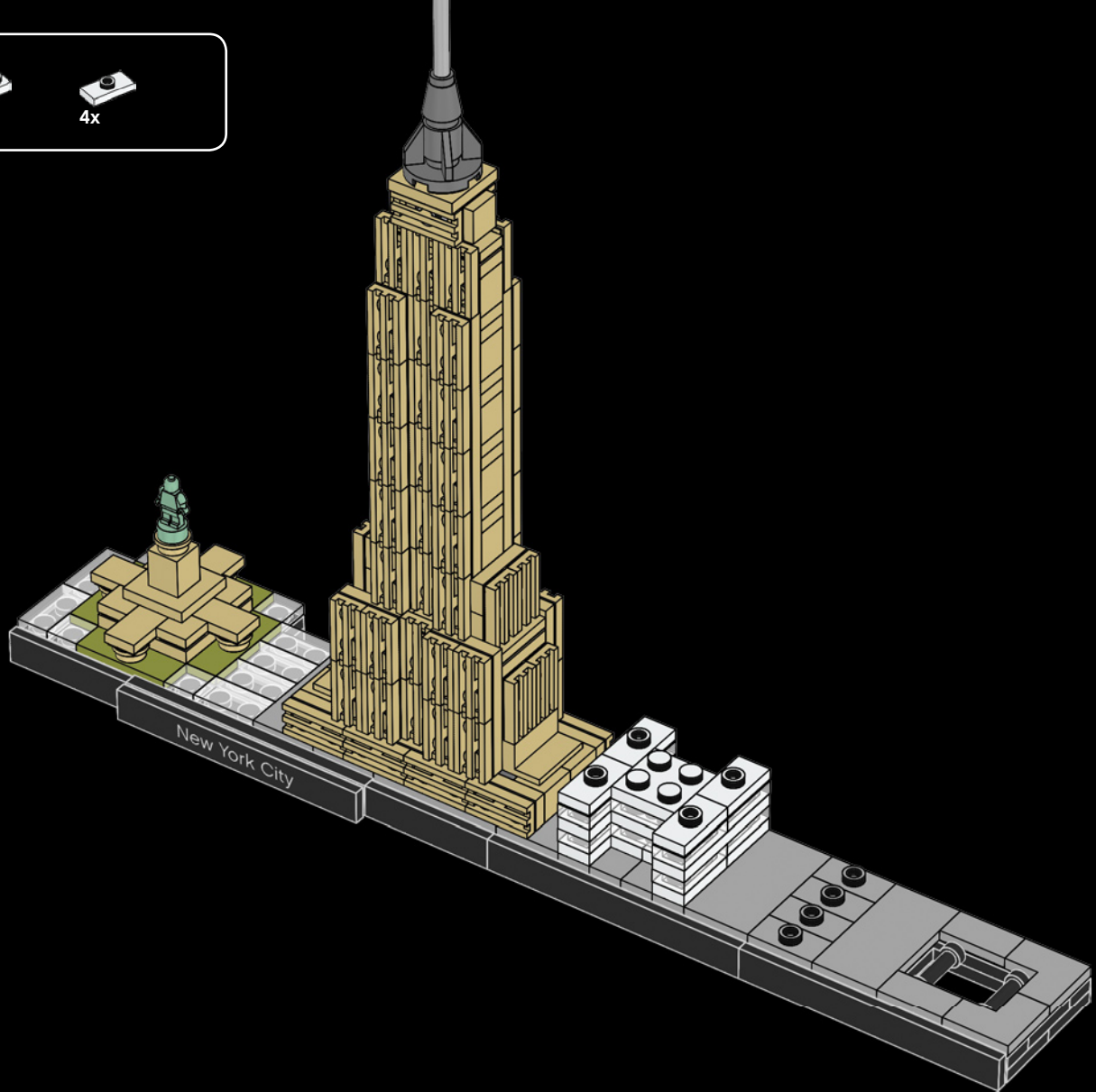



2x

54

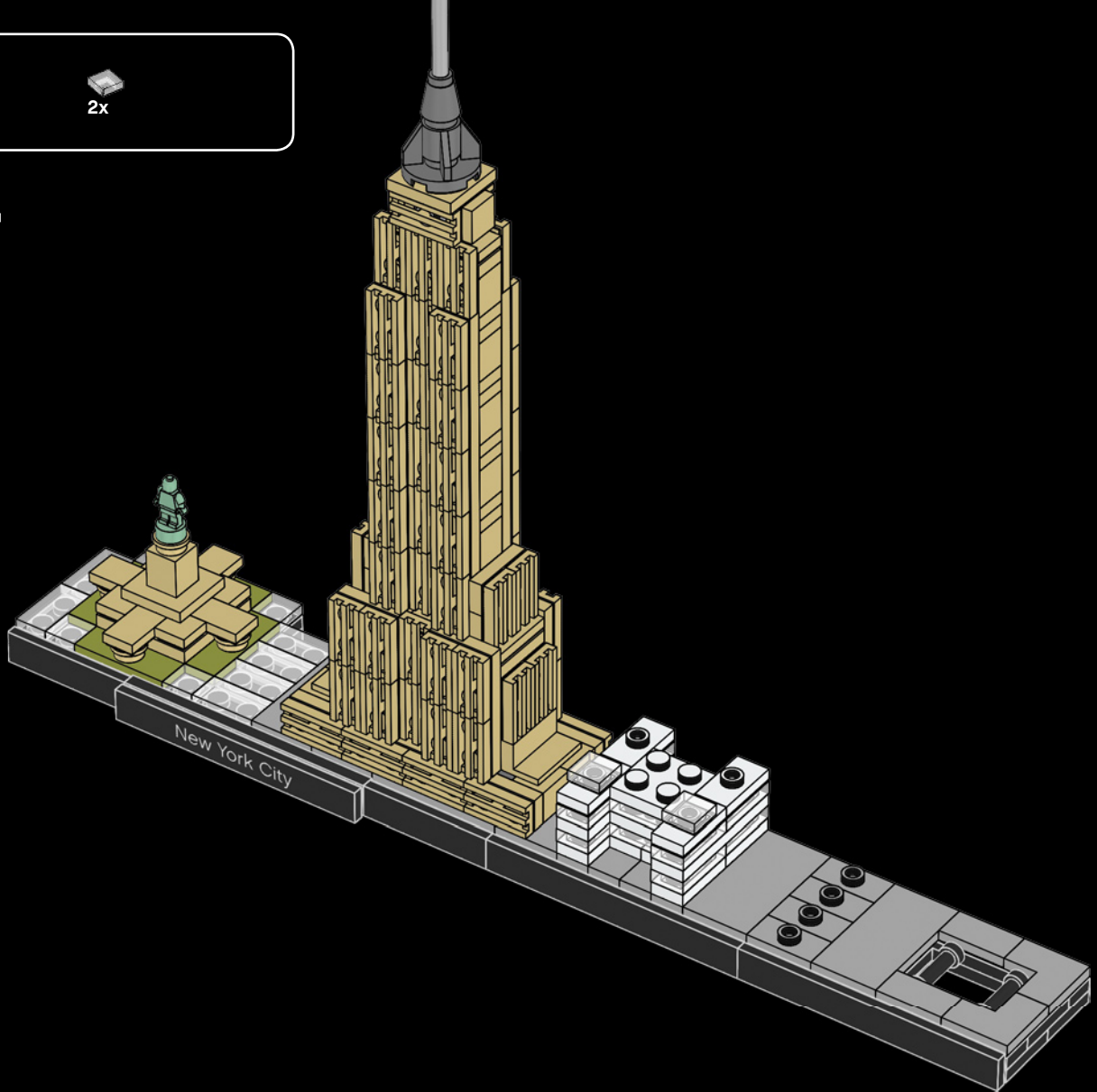



4x

55

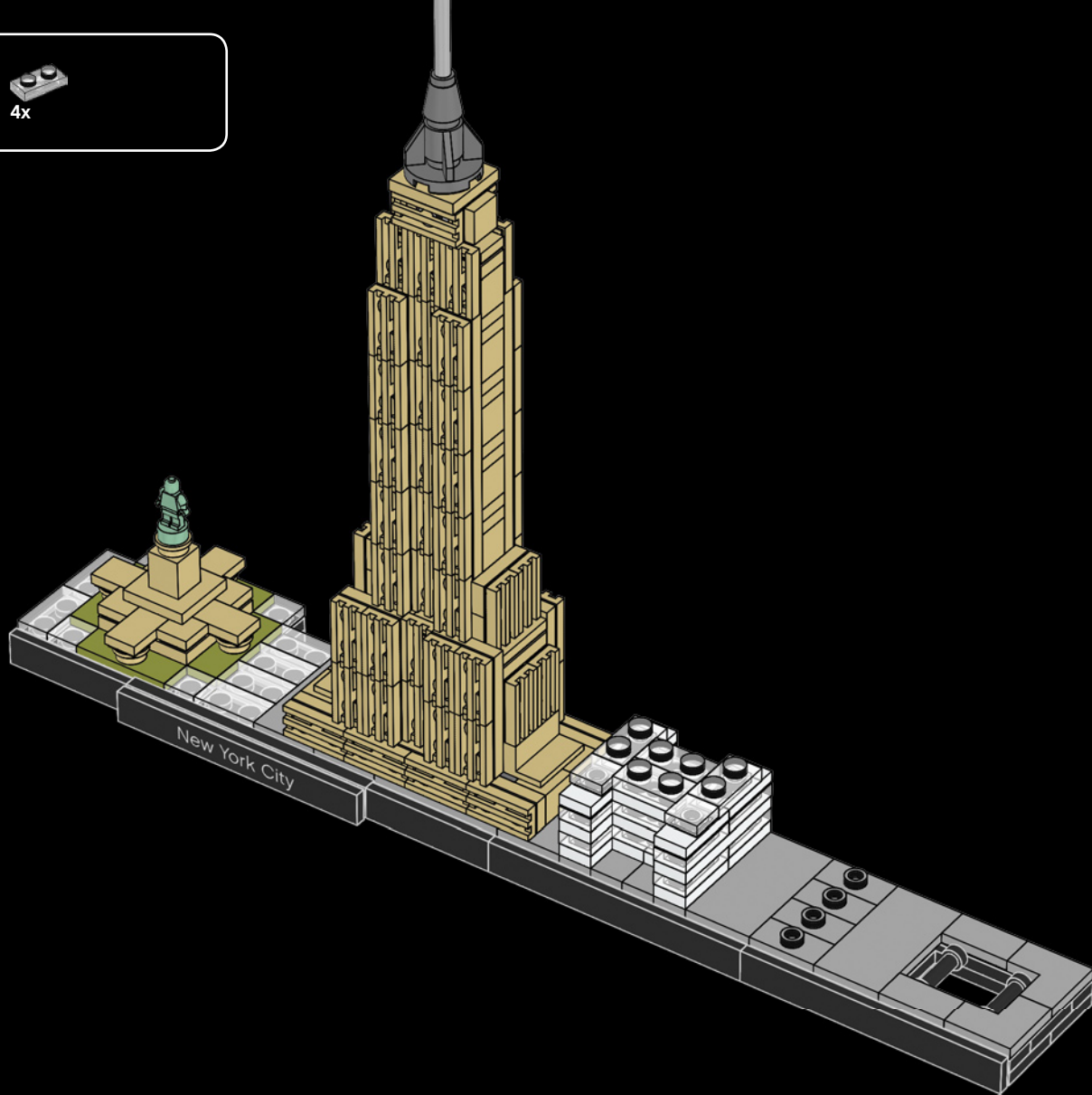

2x

56

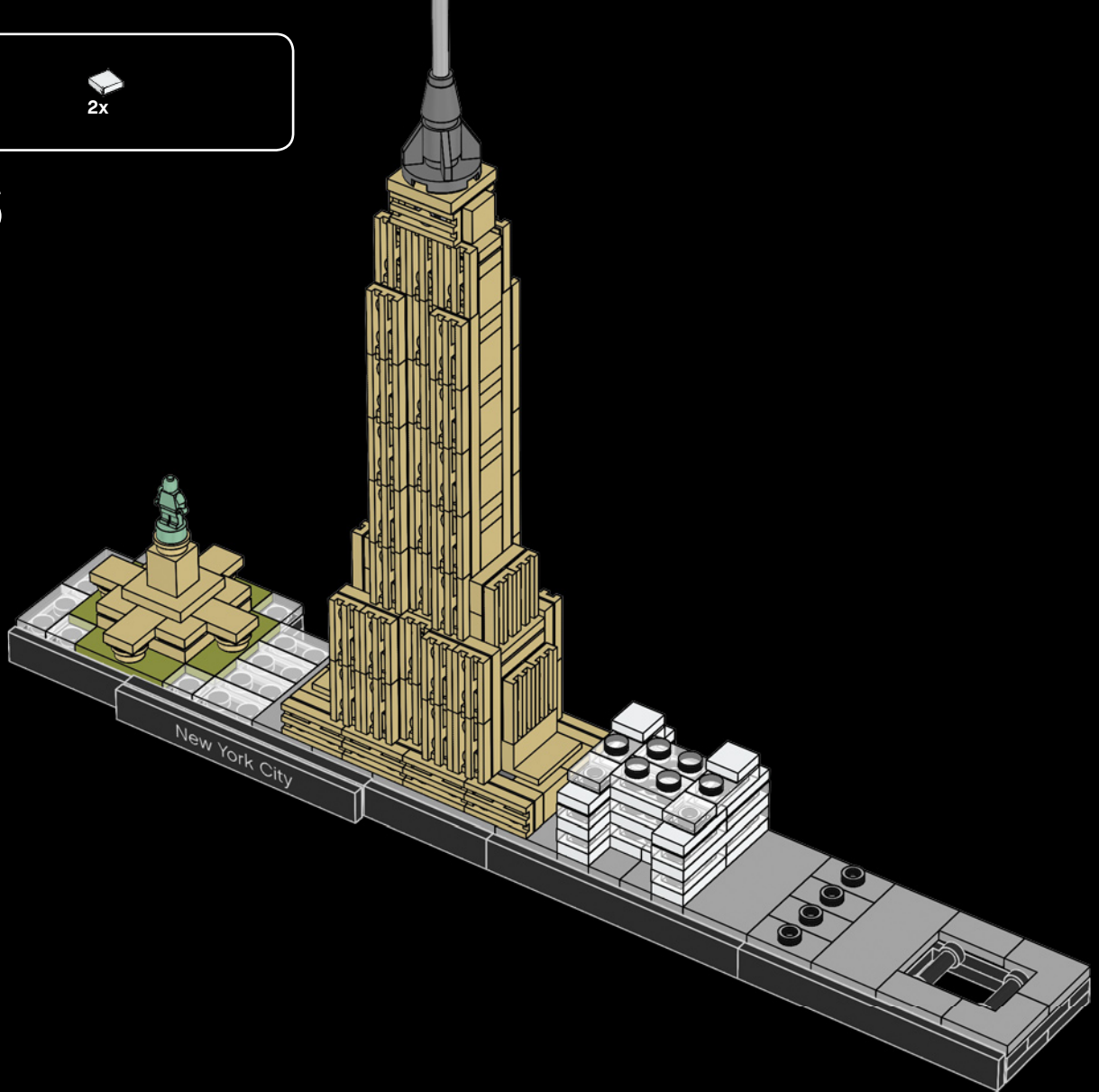



1x



2x

57

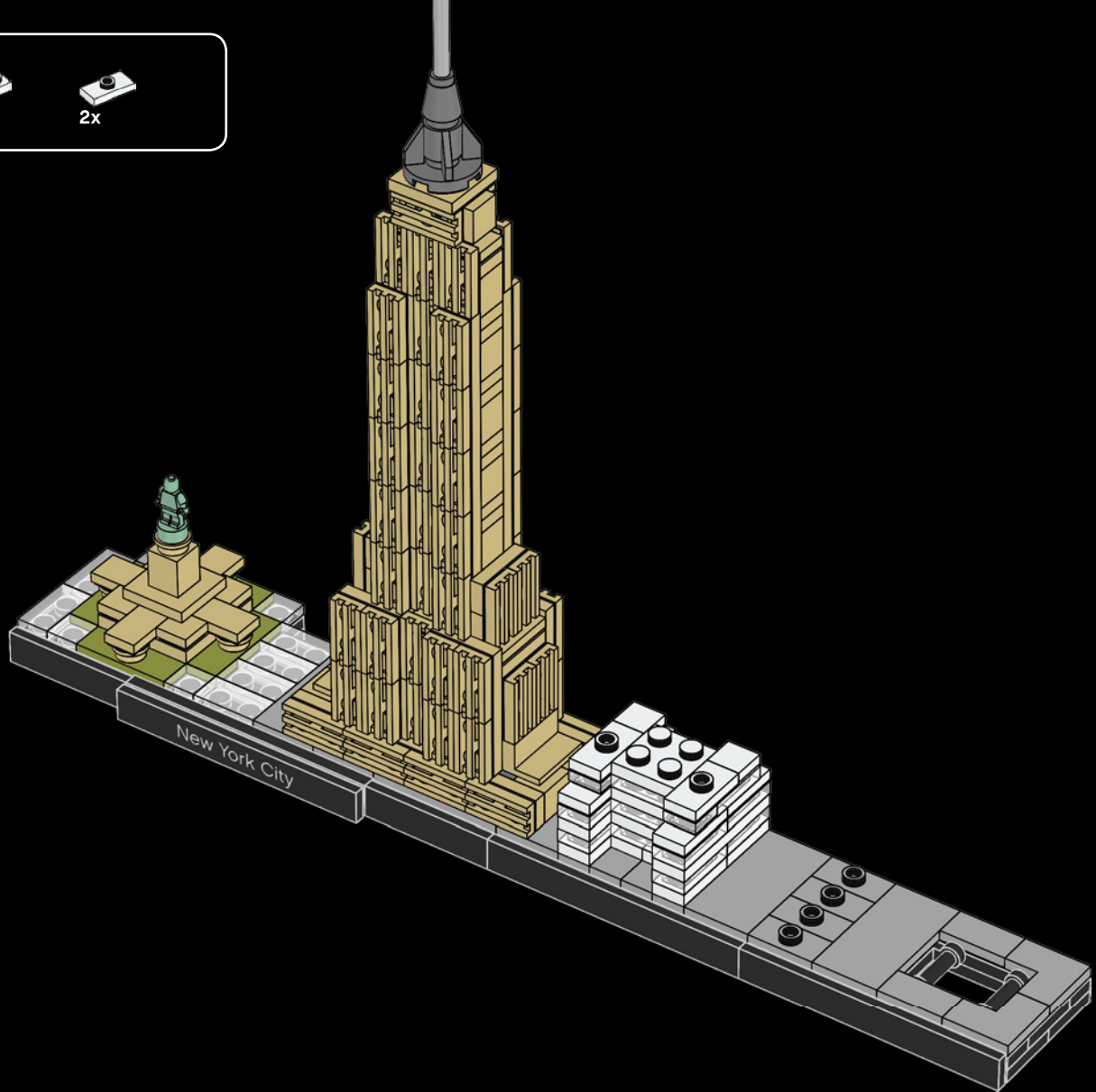



58

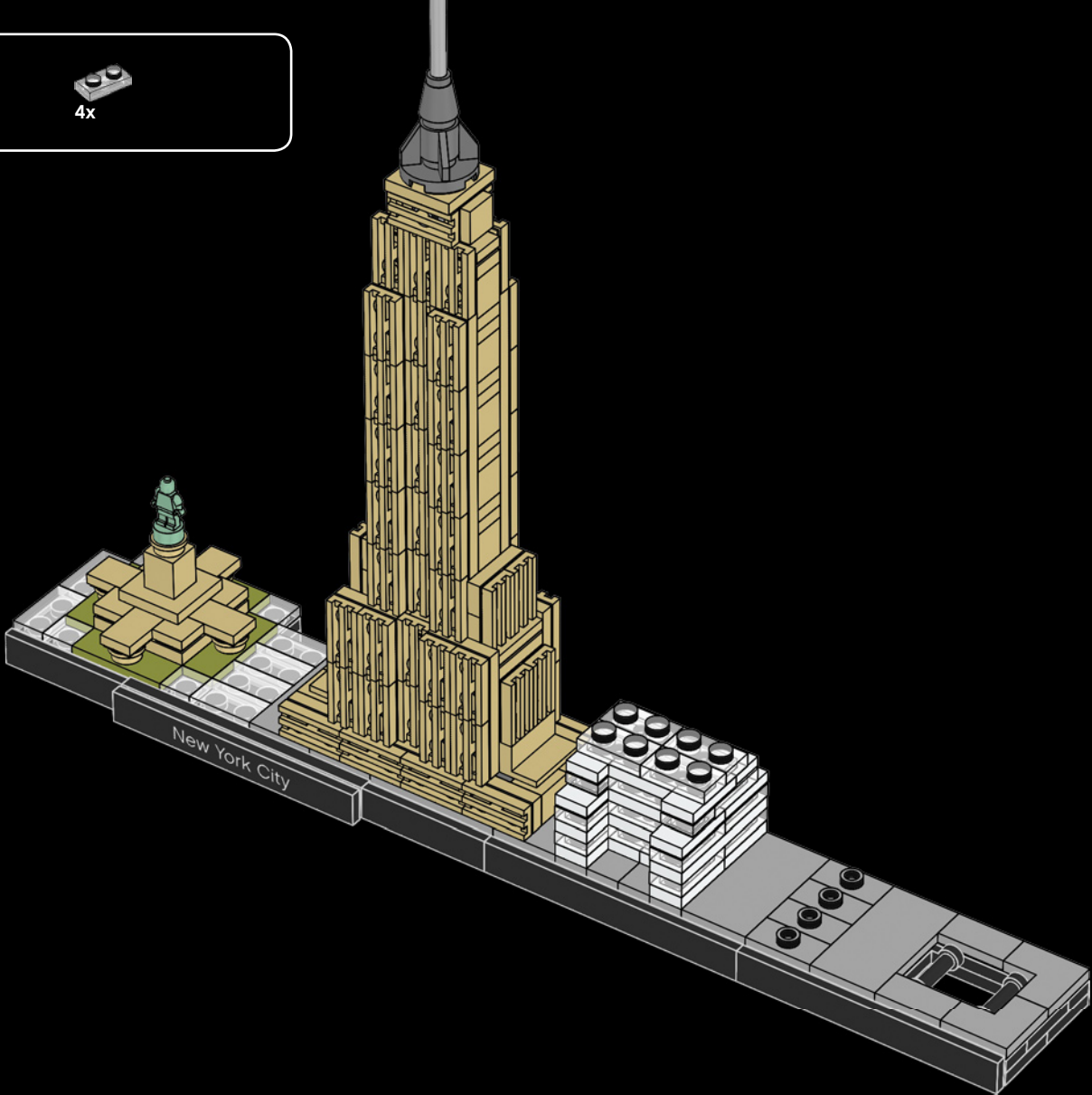



4x

59

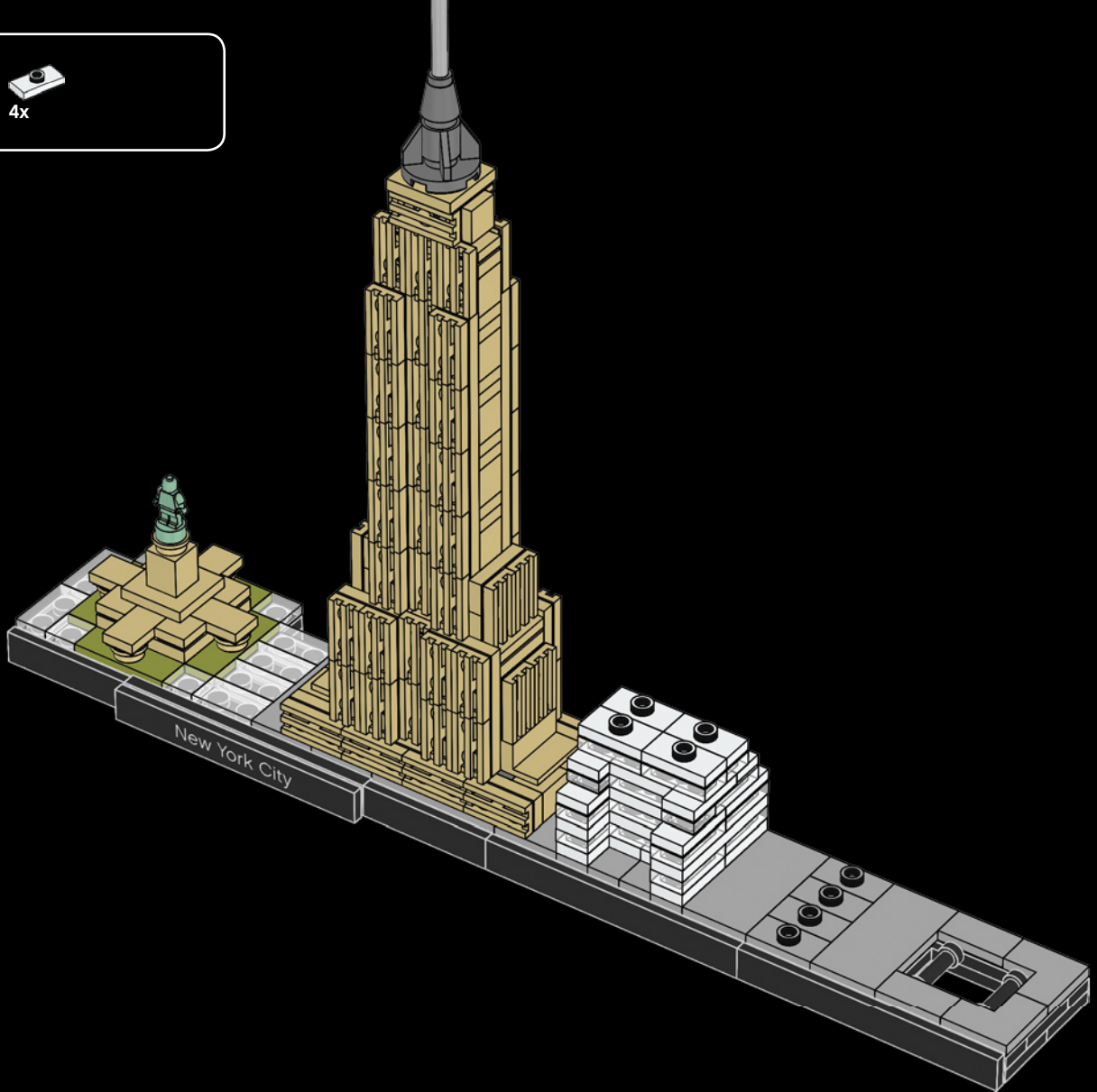

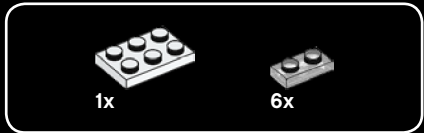

60

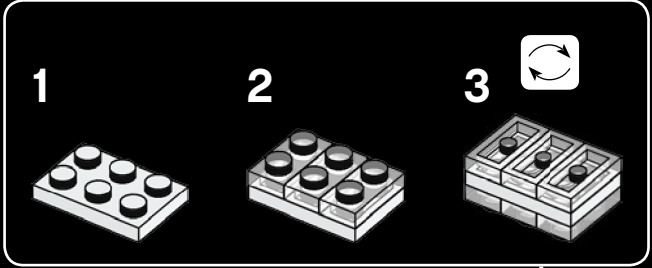
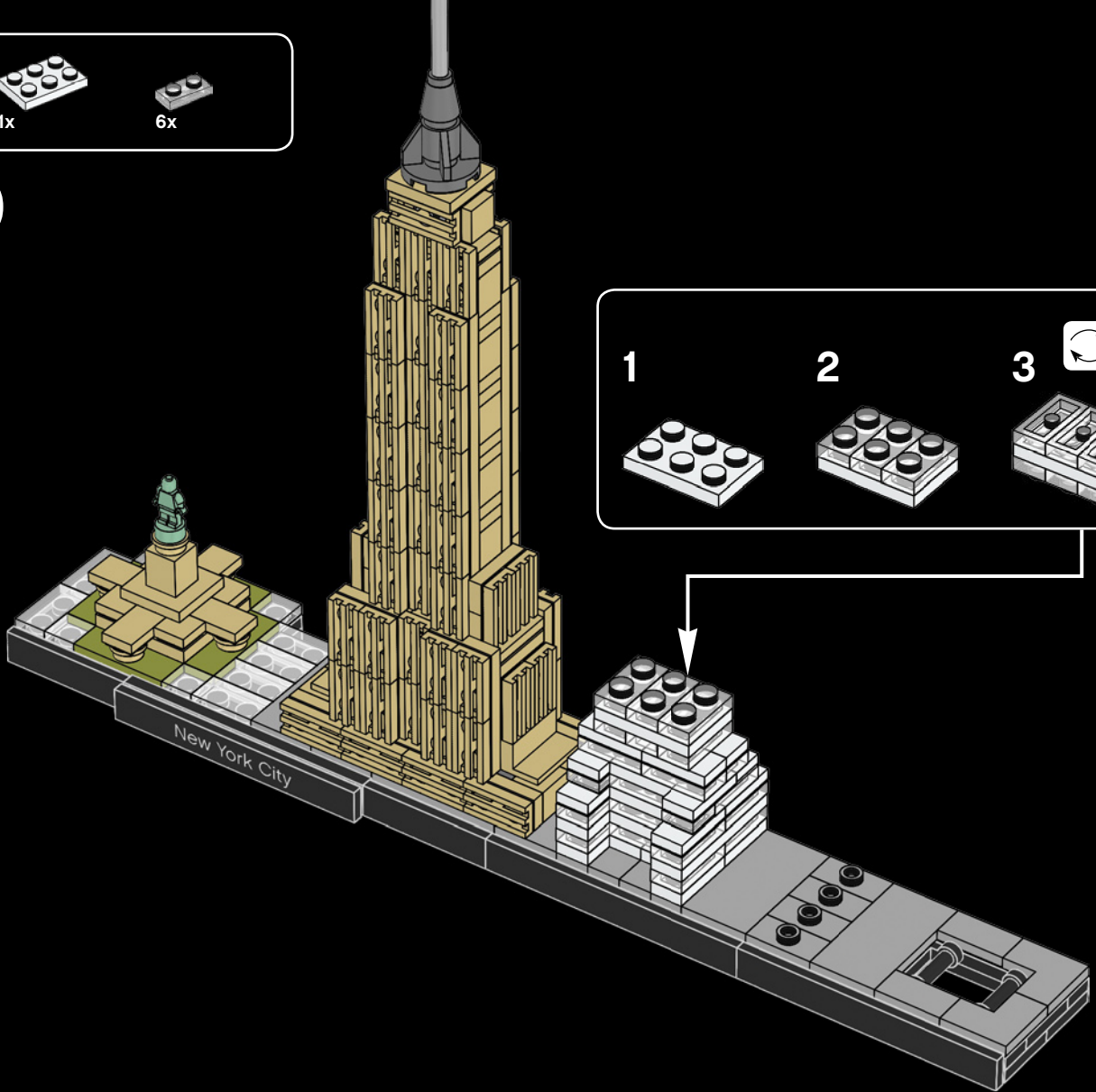



61



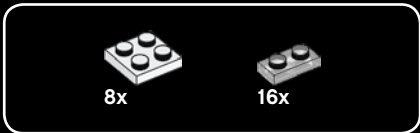

62

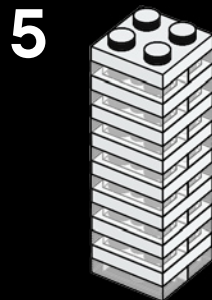
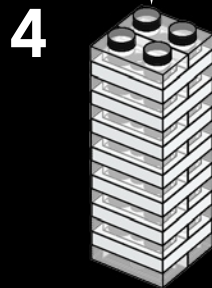
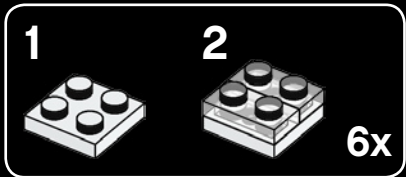
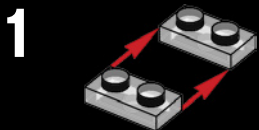

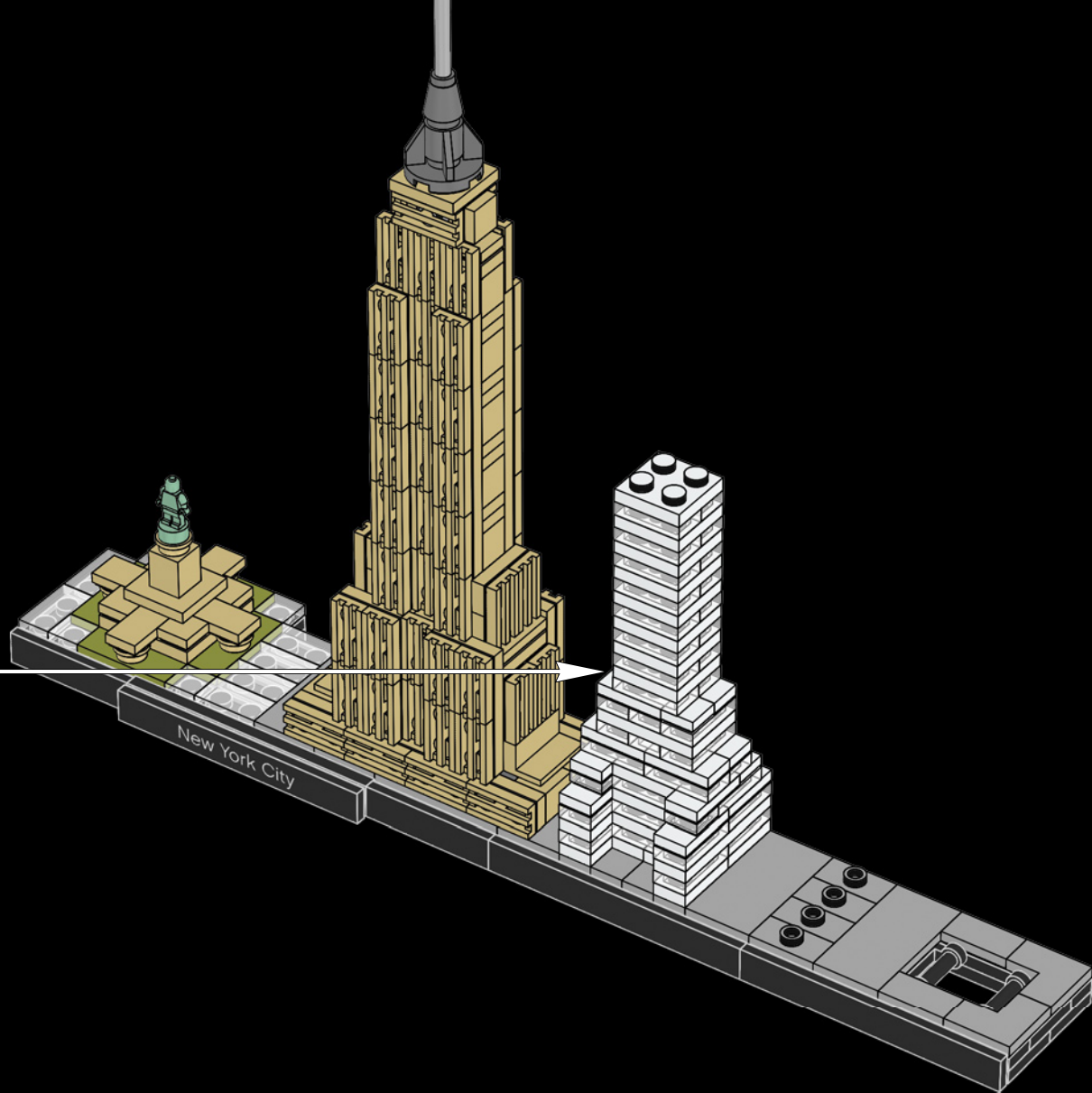



63

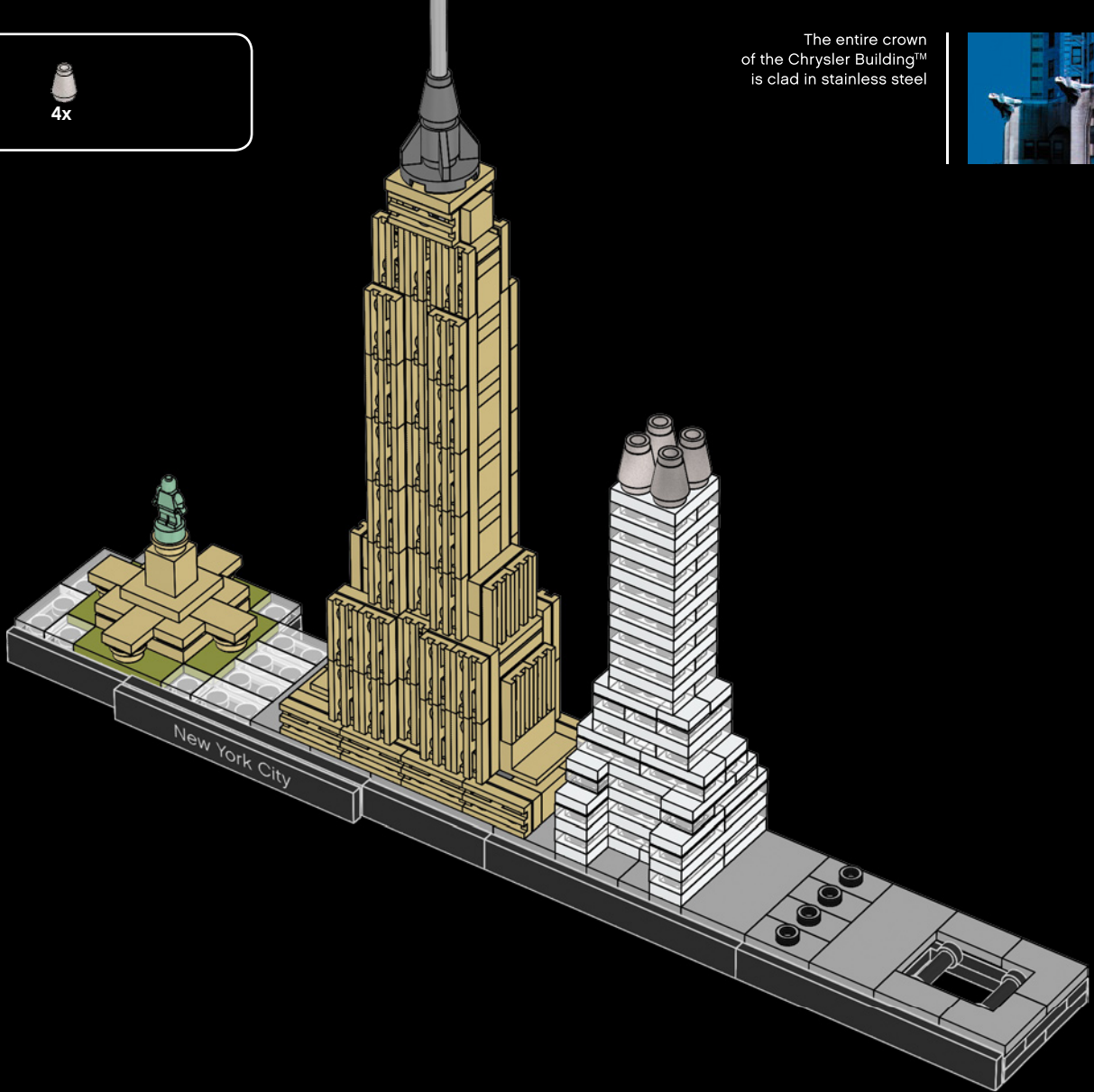

The entire crown
of the Chrysler Building™
is clad in stainless steel



© Chrysler Building



64



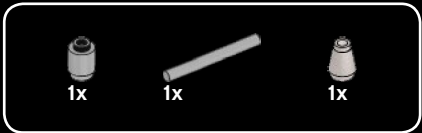

65

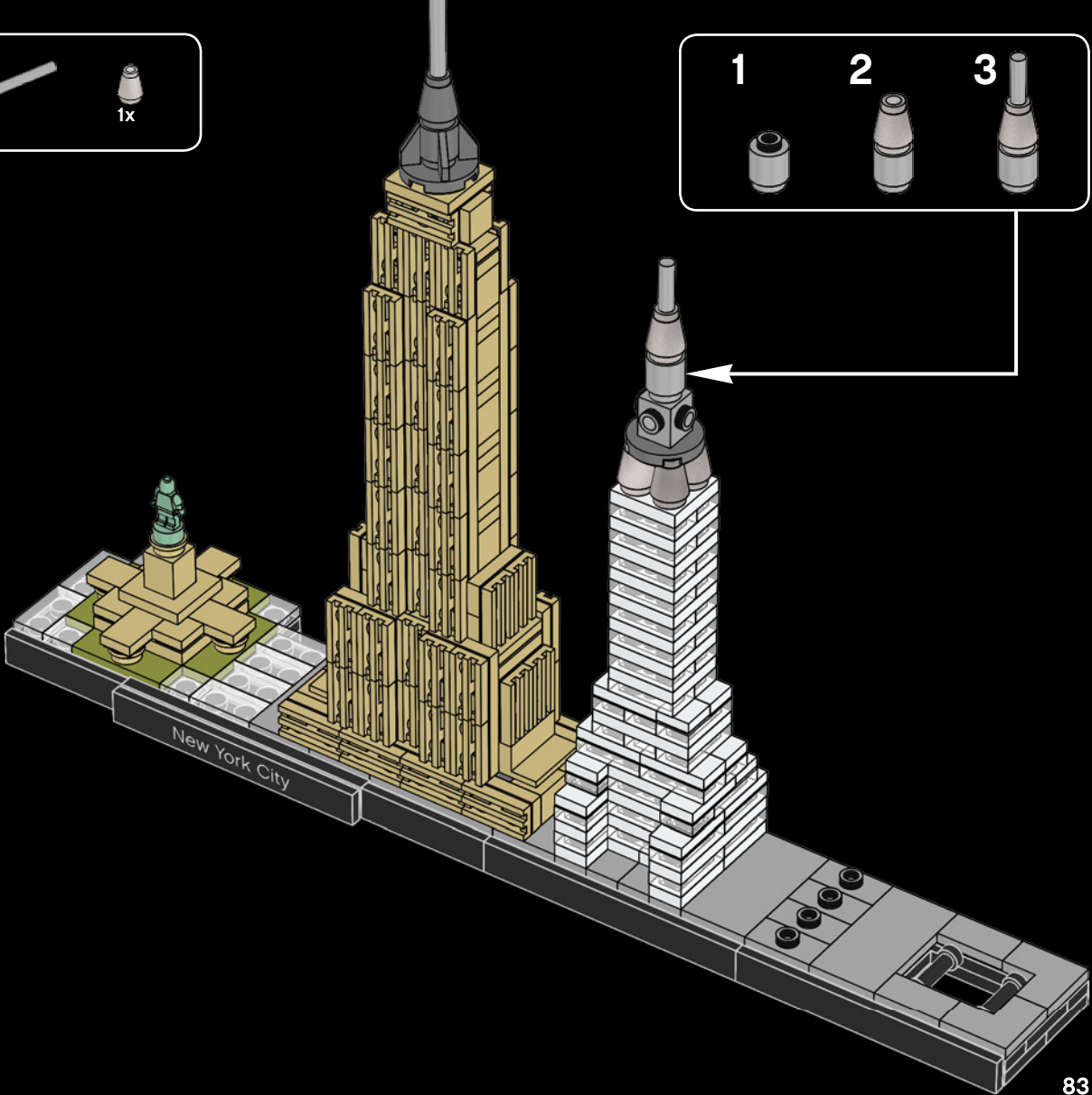



4x

66



4x

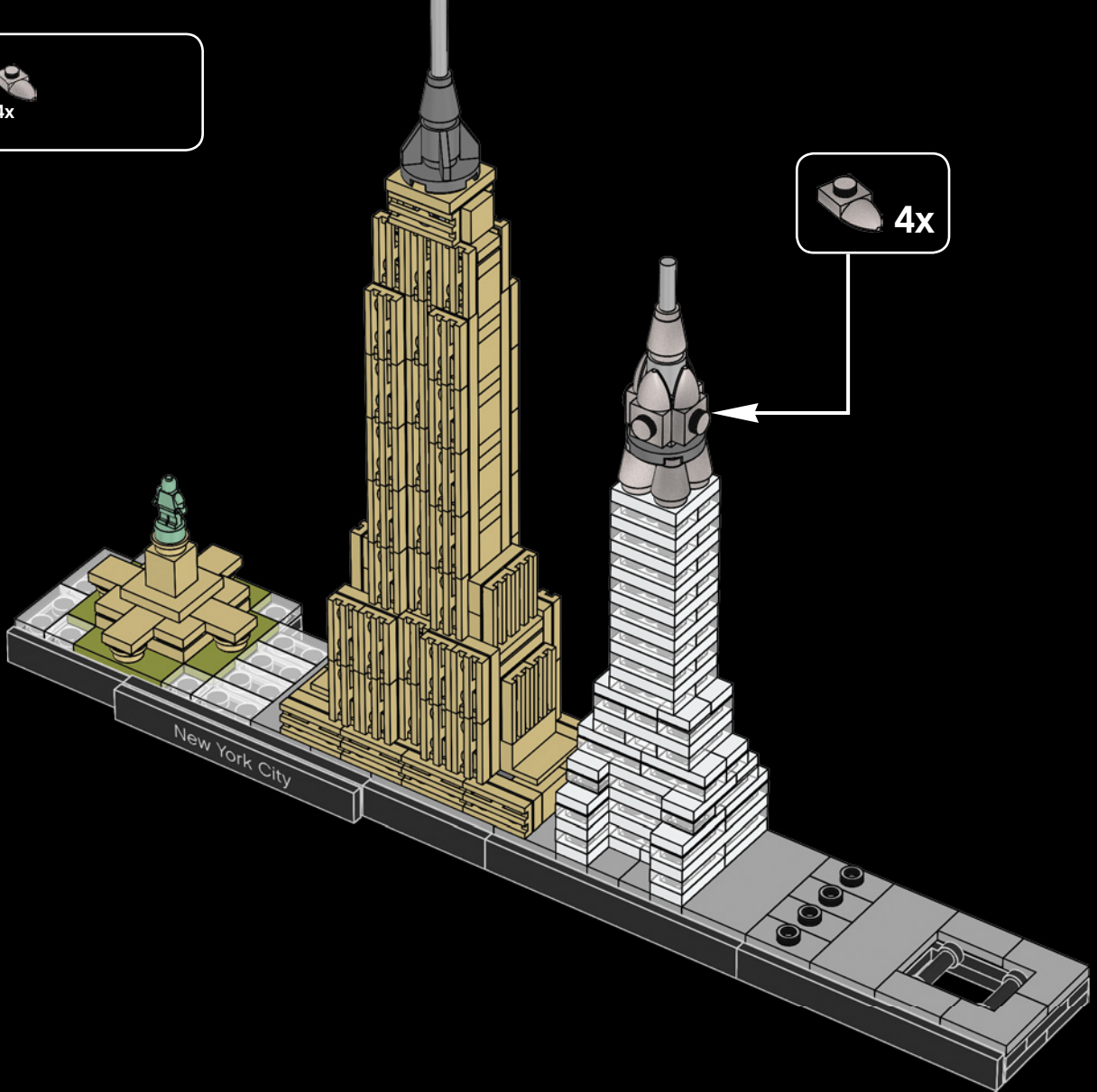

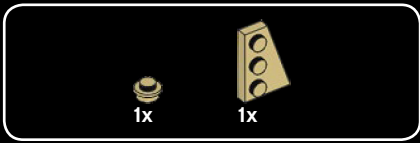

67



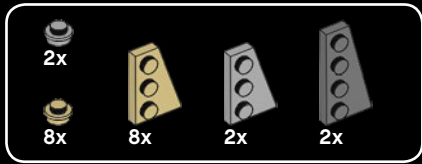

68

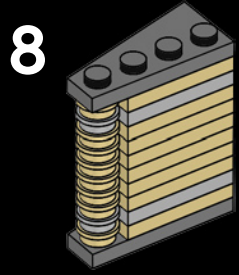
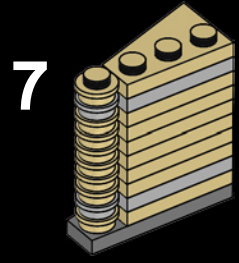
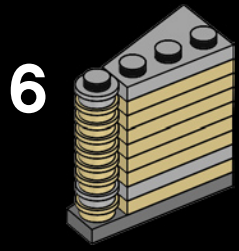
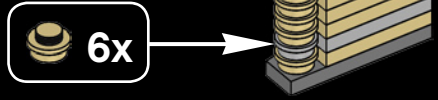
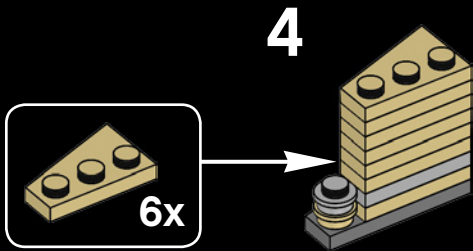
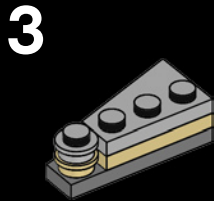
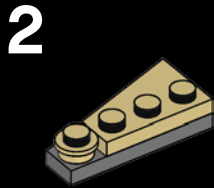
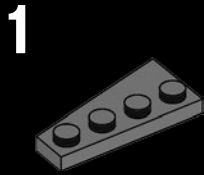

"I found myself agape,
admiring a sky-scraper...
plowing up through
the traffic of Broadway
and Fifth Avenue in the
afternoon light." H.G Wells

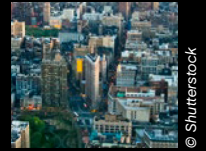

© Shutterstock

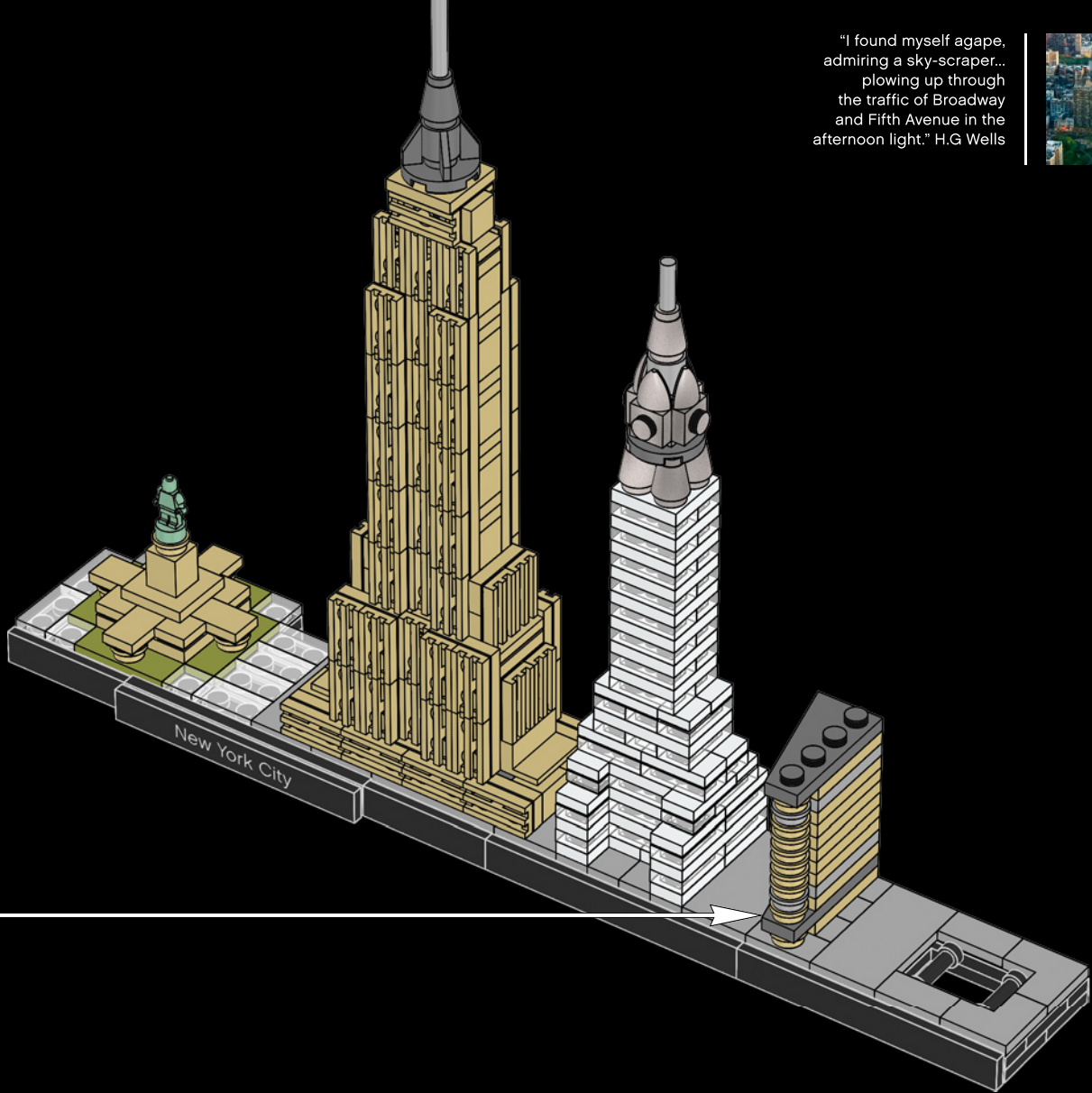

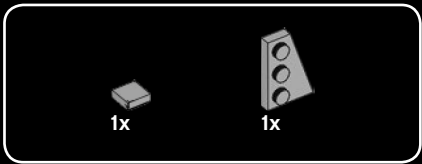

69

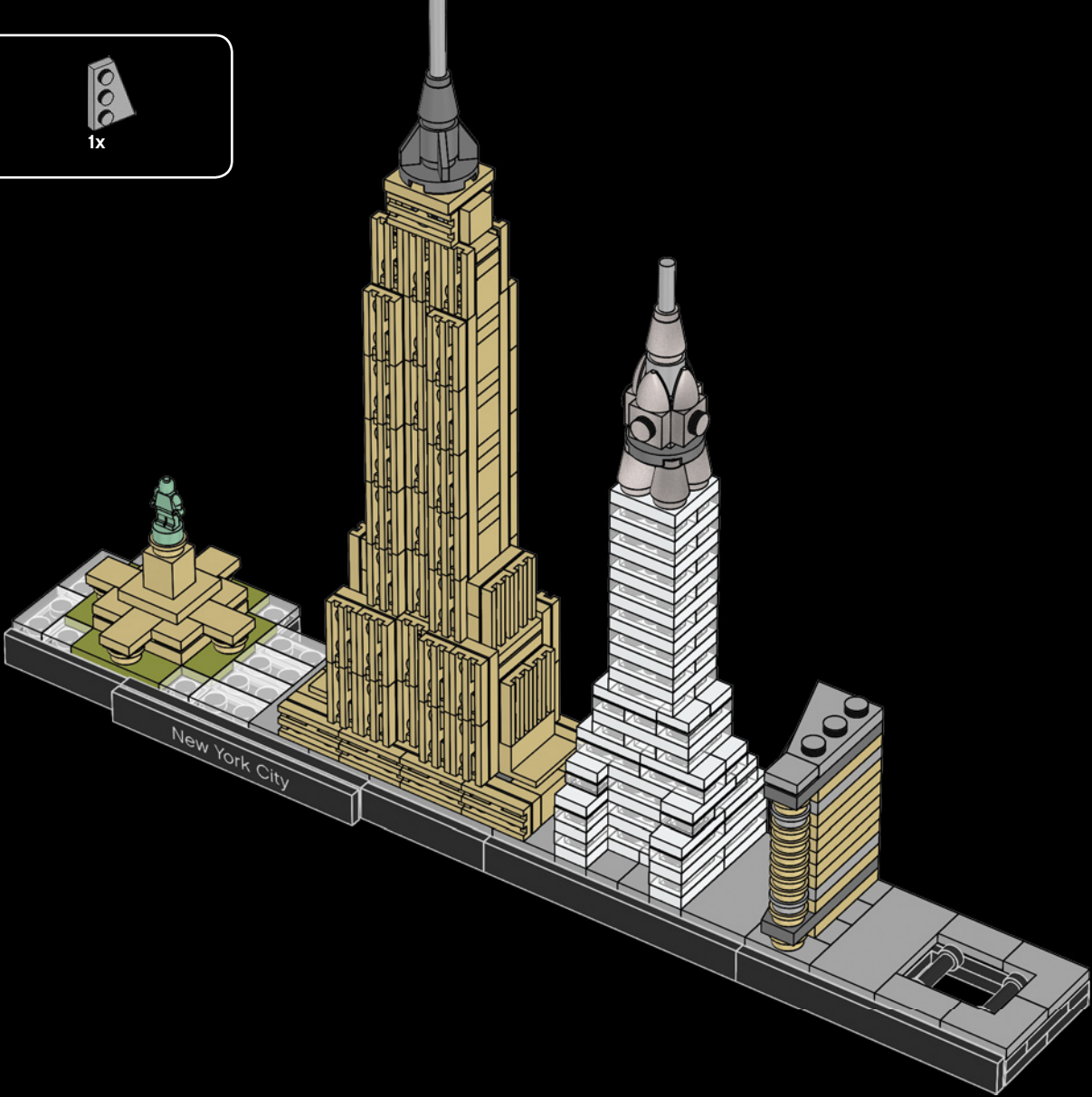

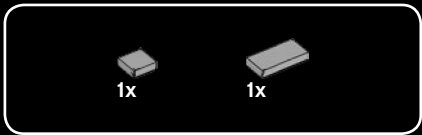

70

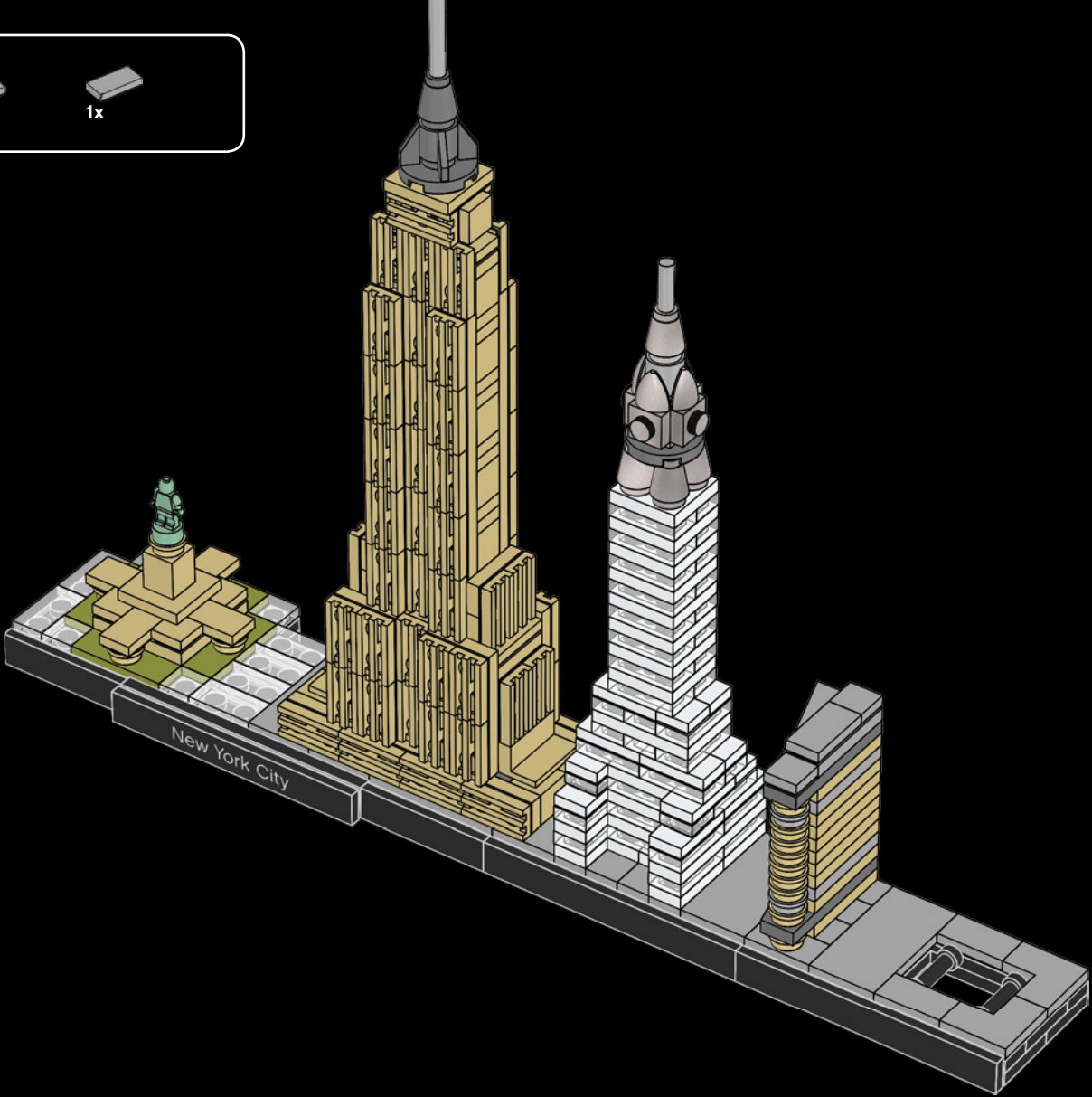



1

1

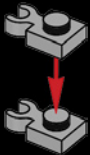

2



3

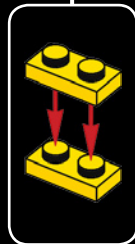
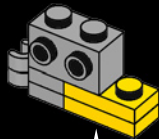

4

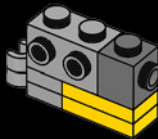

5



6

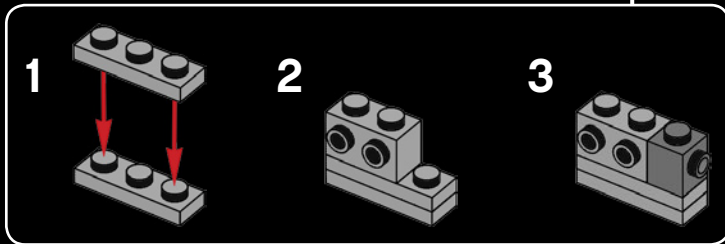
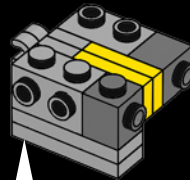

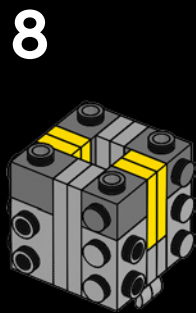
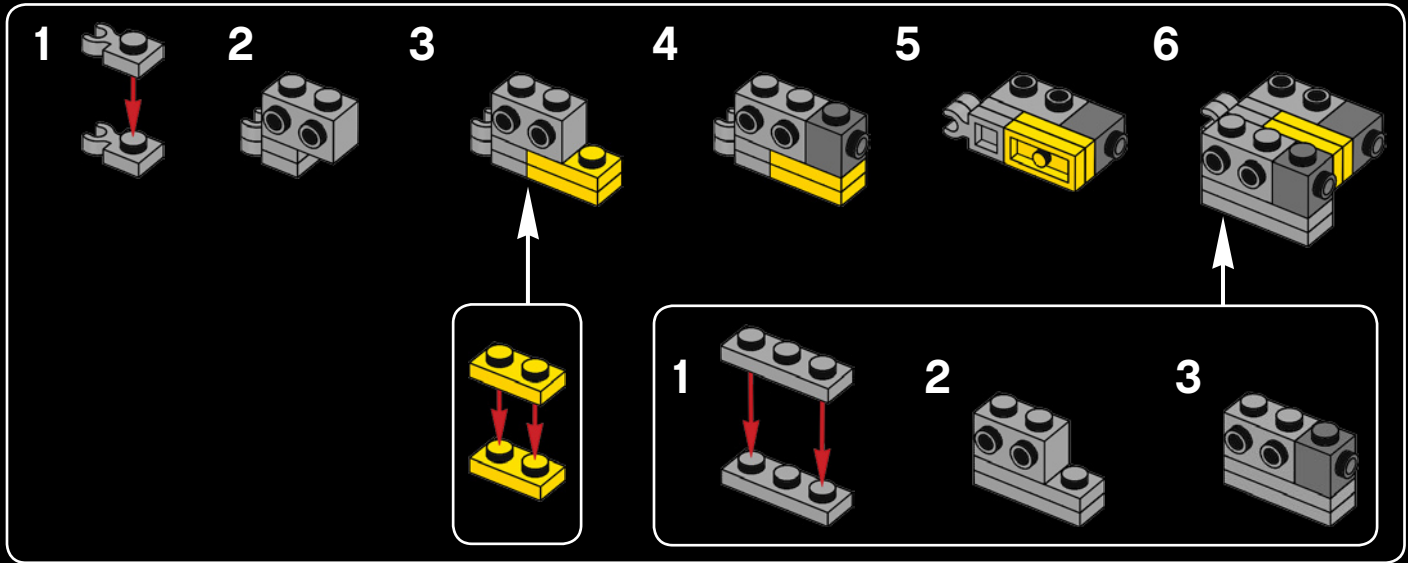



2x

9

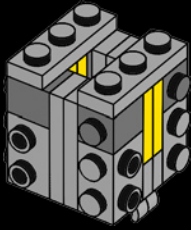

1x

10

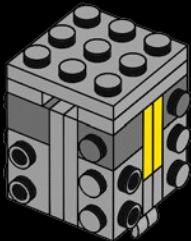

1x

11

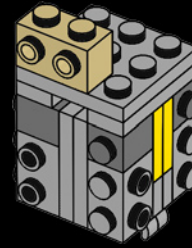

3x

12

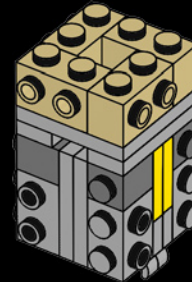

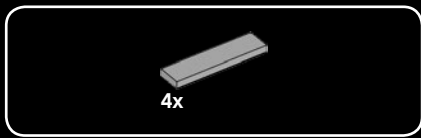

13

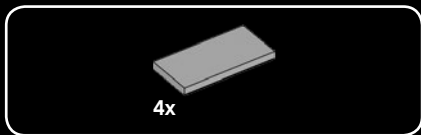
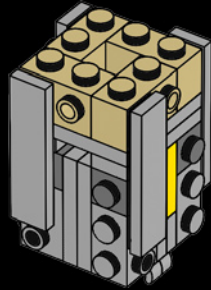

14

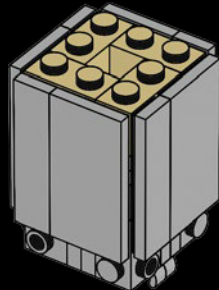

15

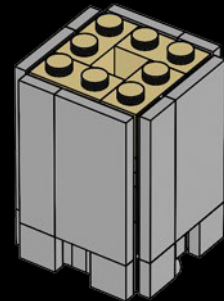

71

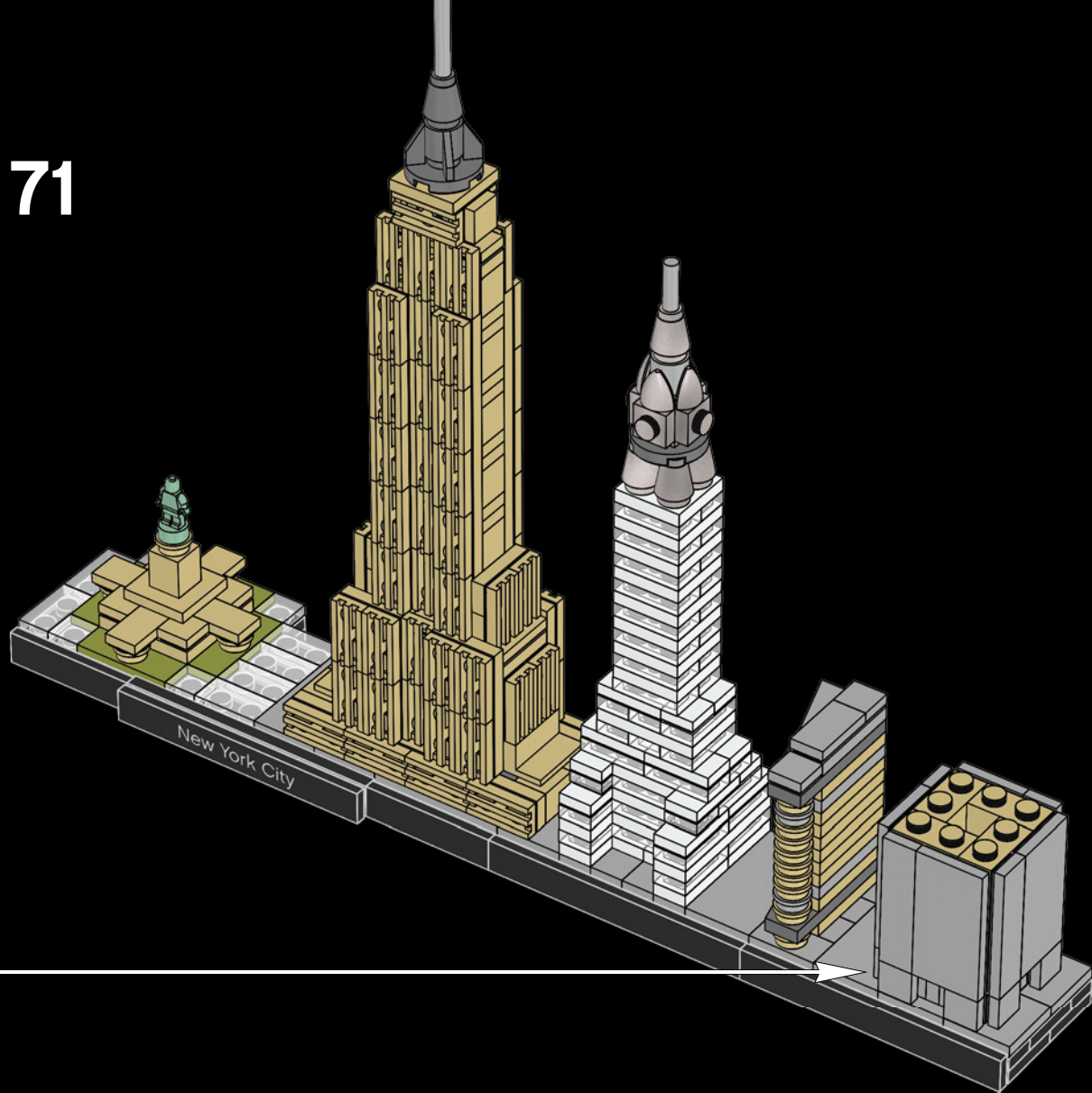

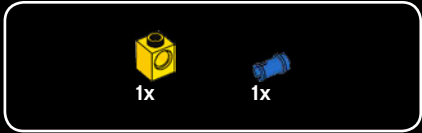
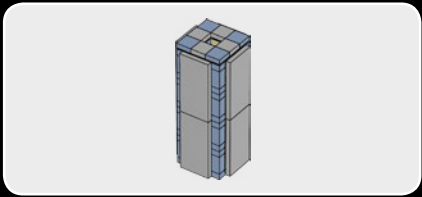

1

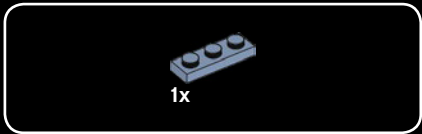
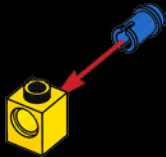

2



3

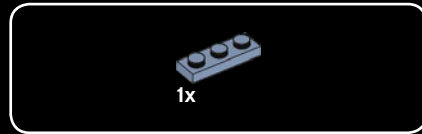

4

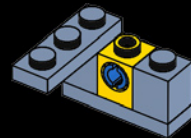

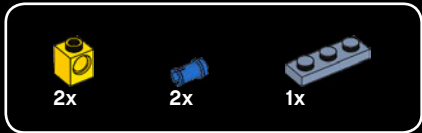

5

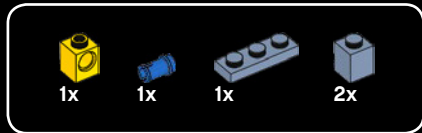
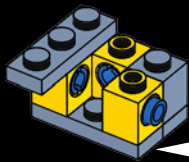
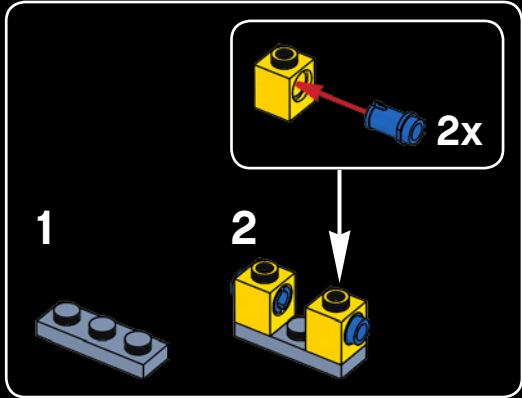

6

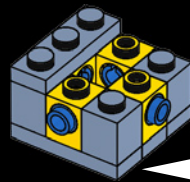
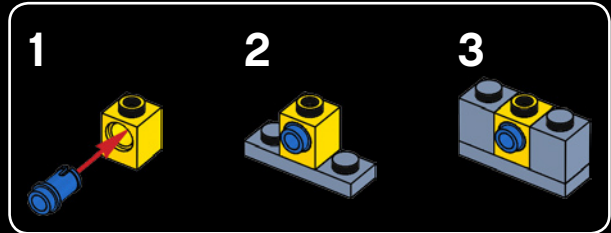

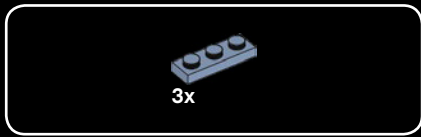

7

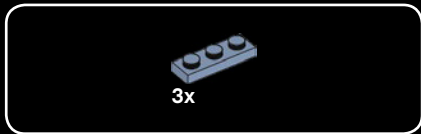
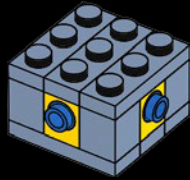

8

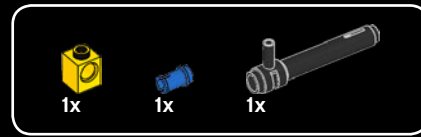
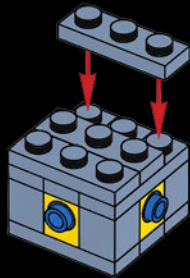

9

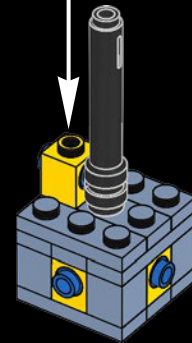
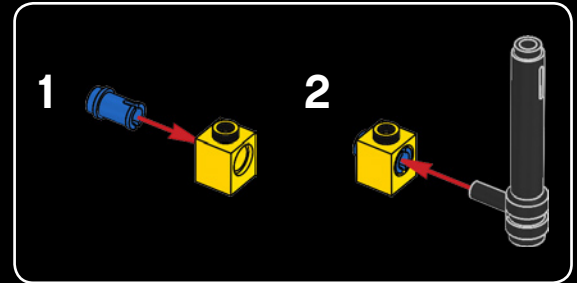



3x



3x

10

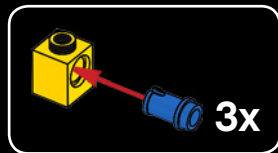
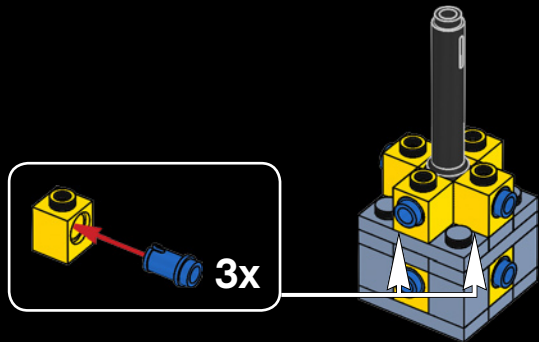

4x

11

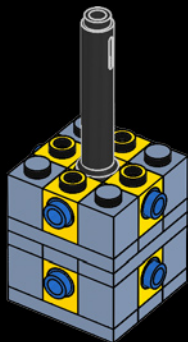

2x



2x

12

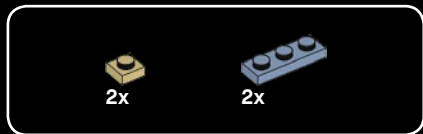
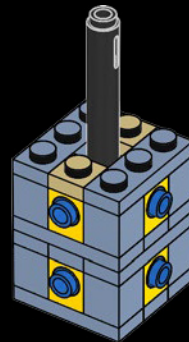

2x

2x

13

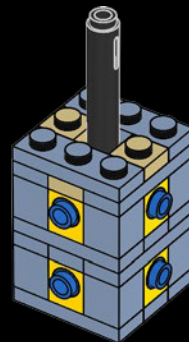

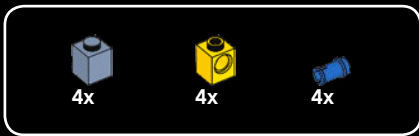

14

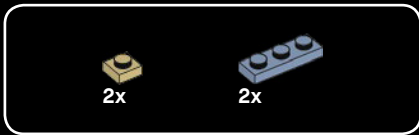
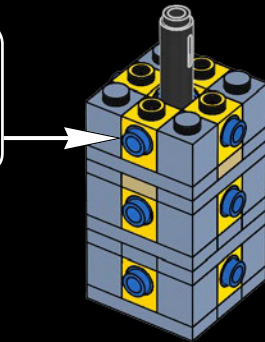
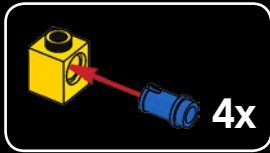

15

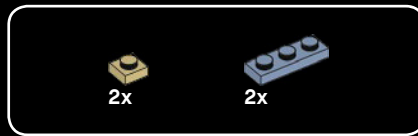
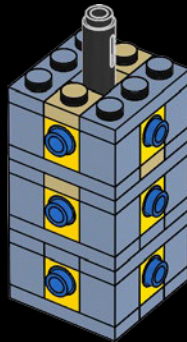

16

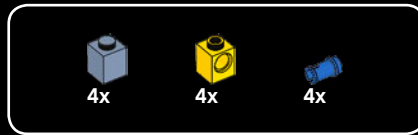
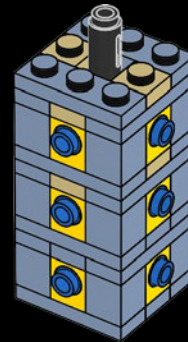

17

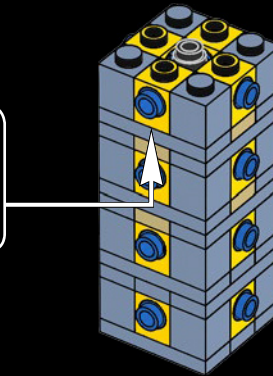
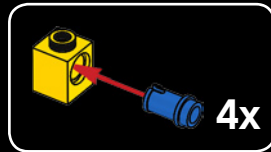



2x



2x

18

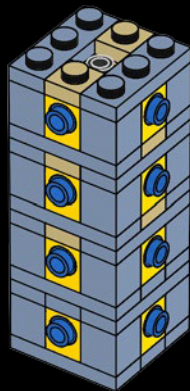

4x



4x

19

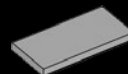
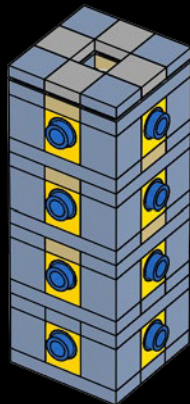

8x

20

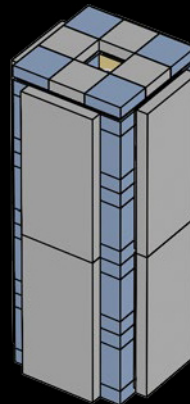

72

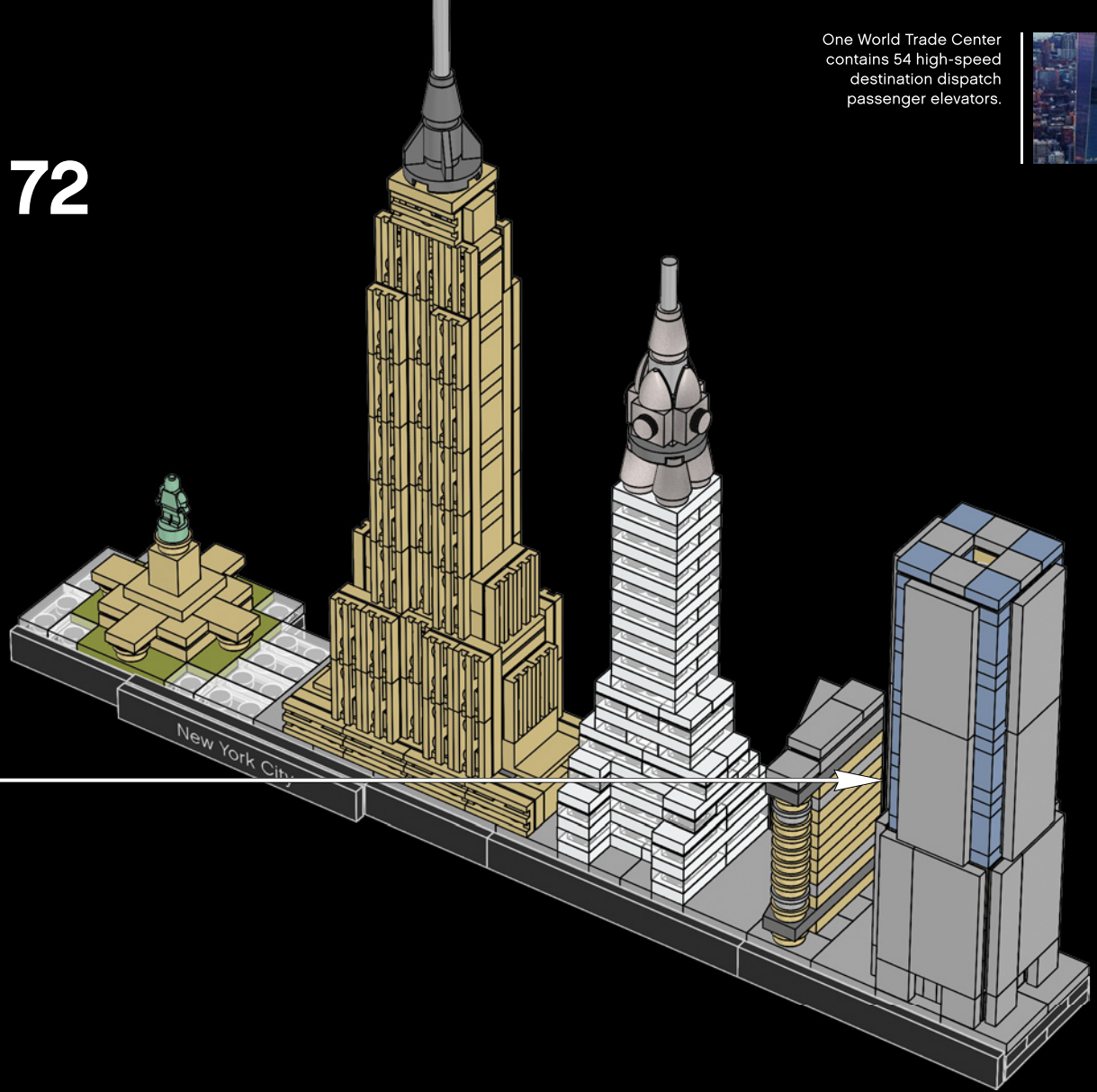

One World Trade Center contains 54 high-speed destination dispatch passenger elevators.



© One World Trade Center

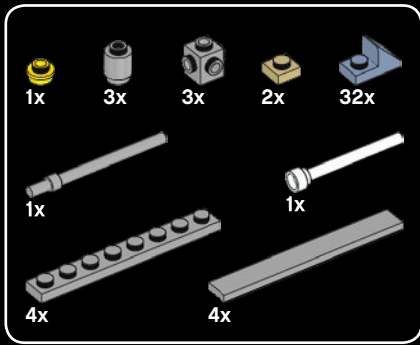

73

1



2

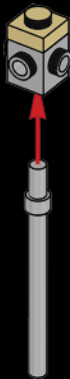

3

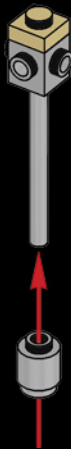

4



5



6



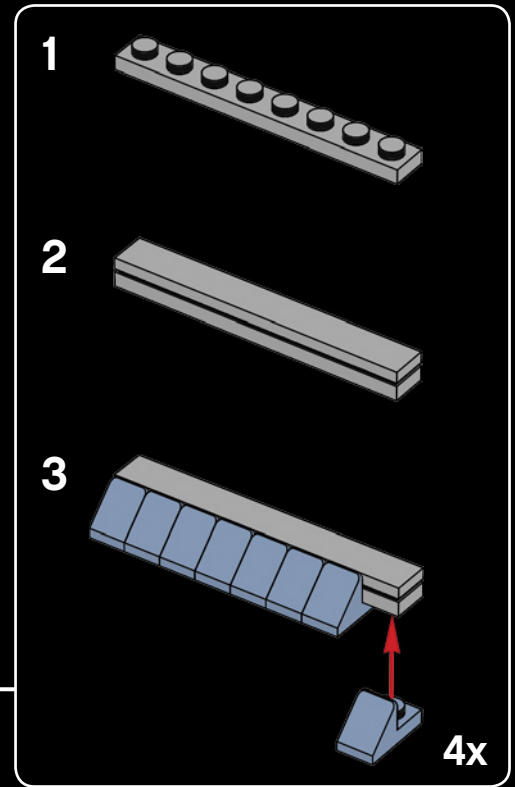
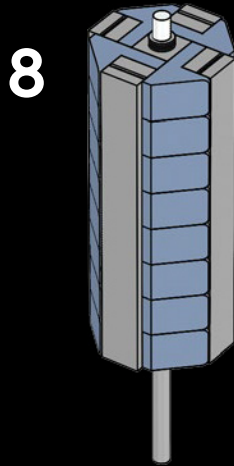
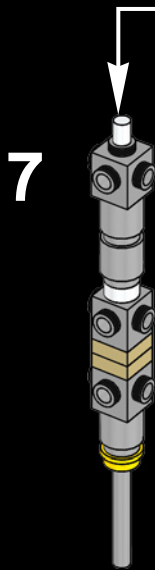
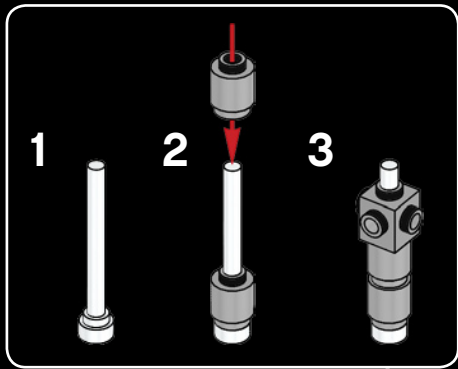

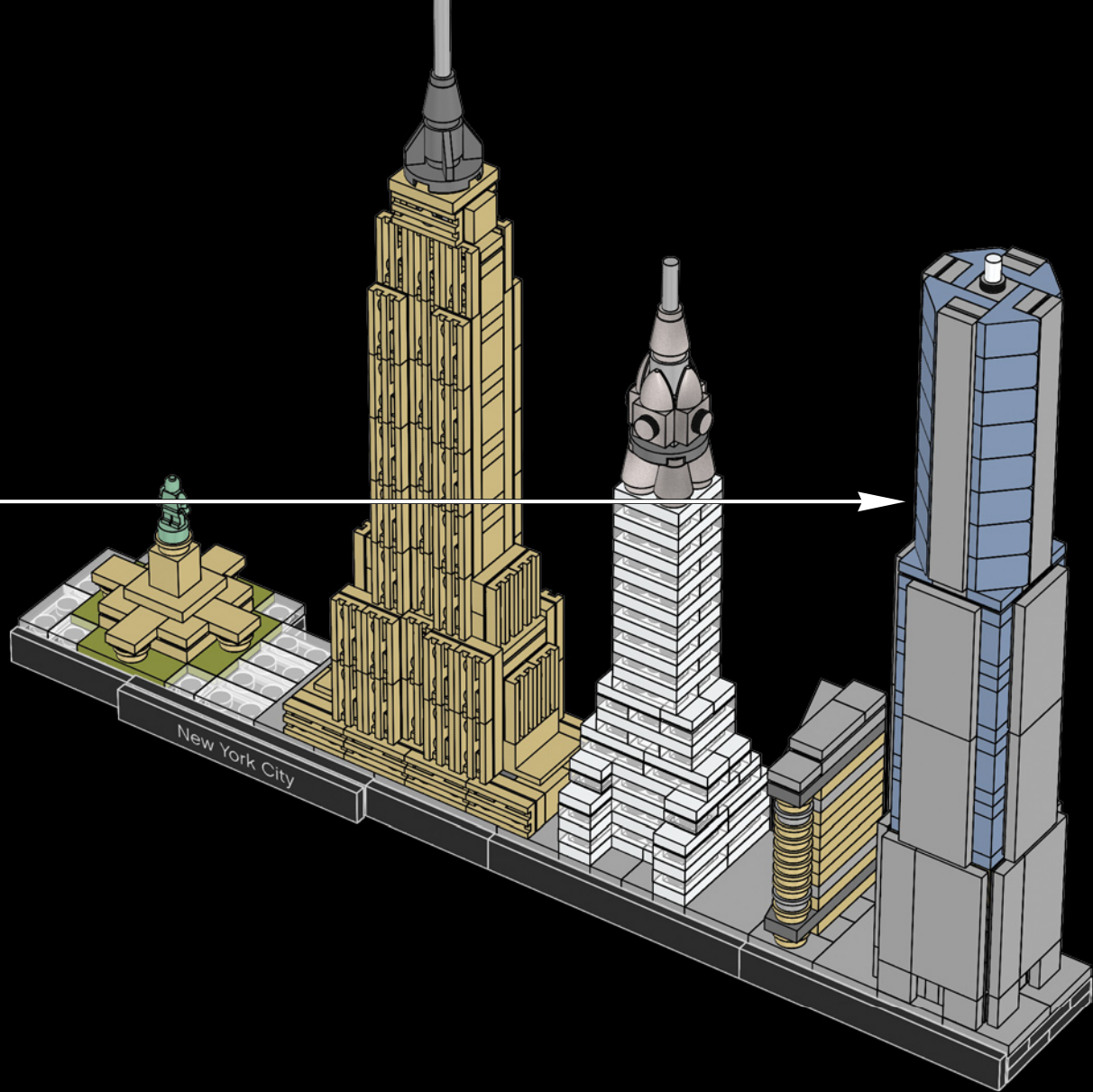

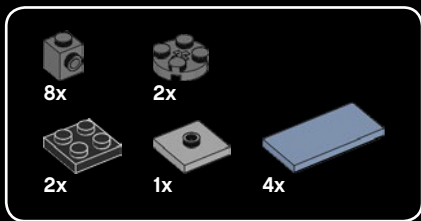

74

1



2



3

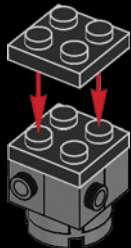

4



5

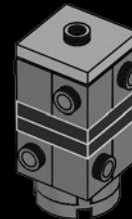

6

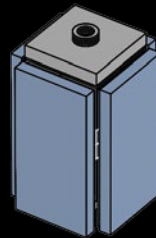

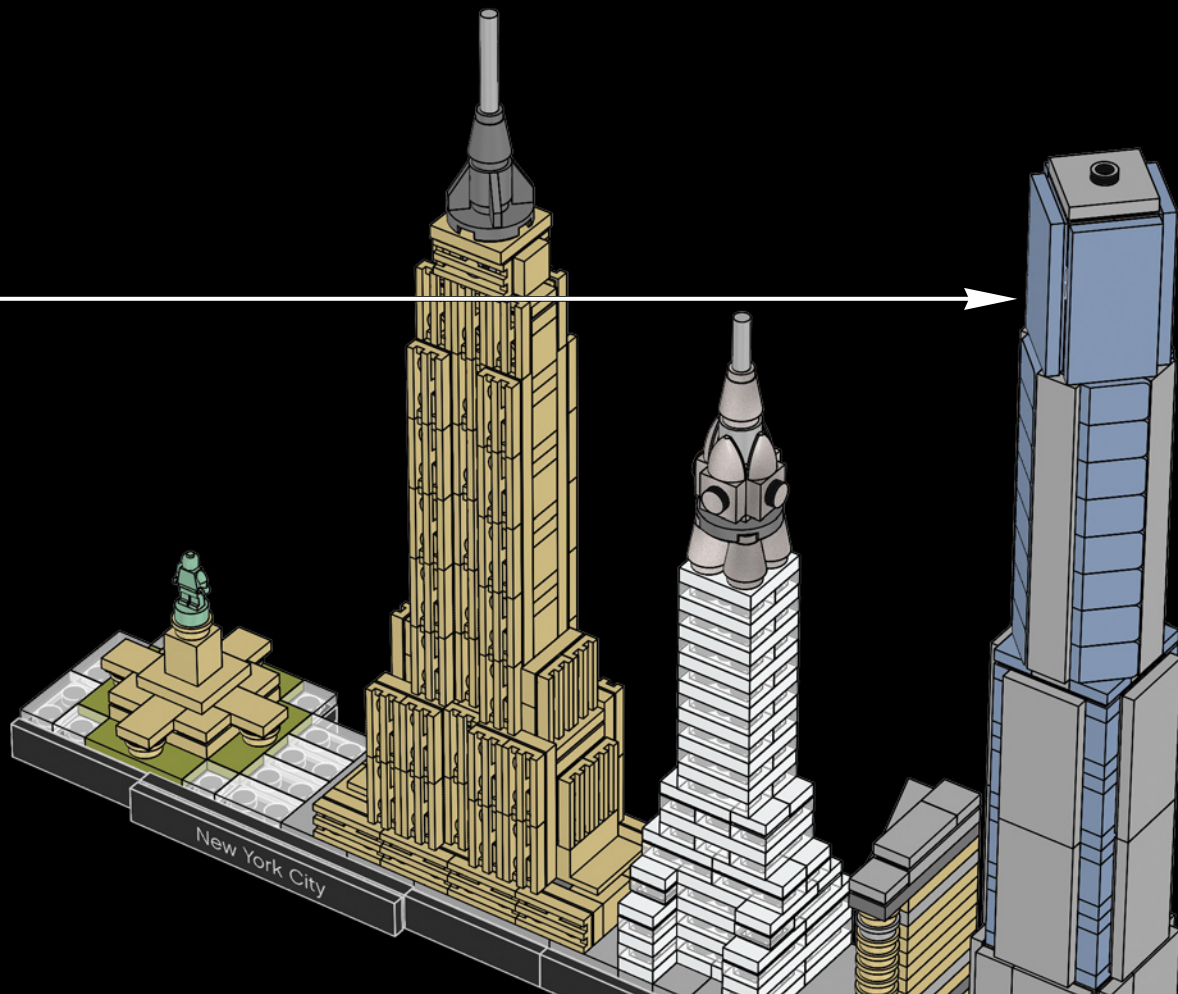

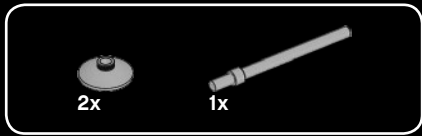

75

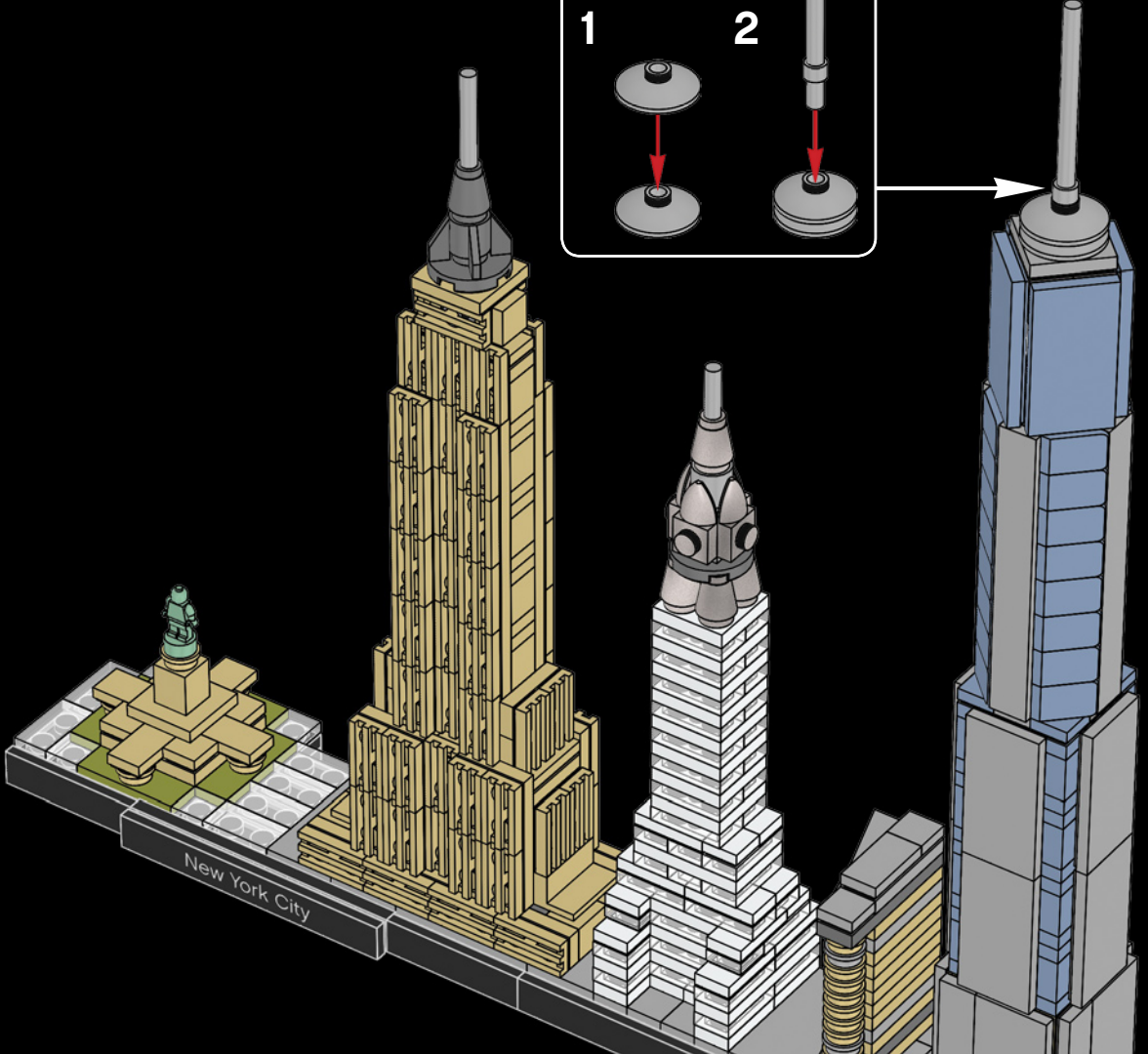
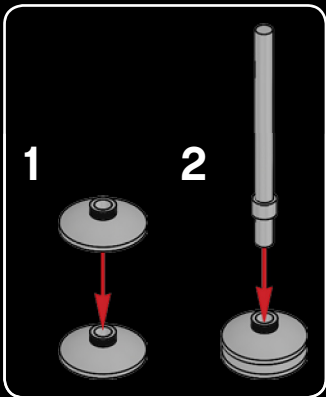

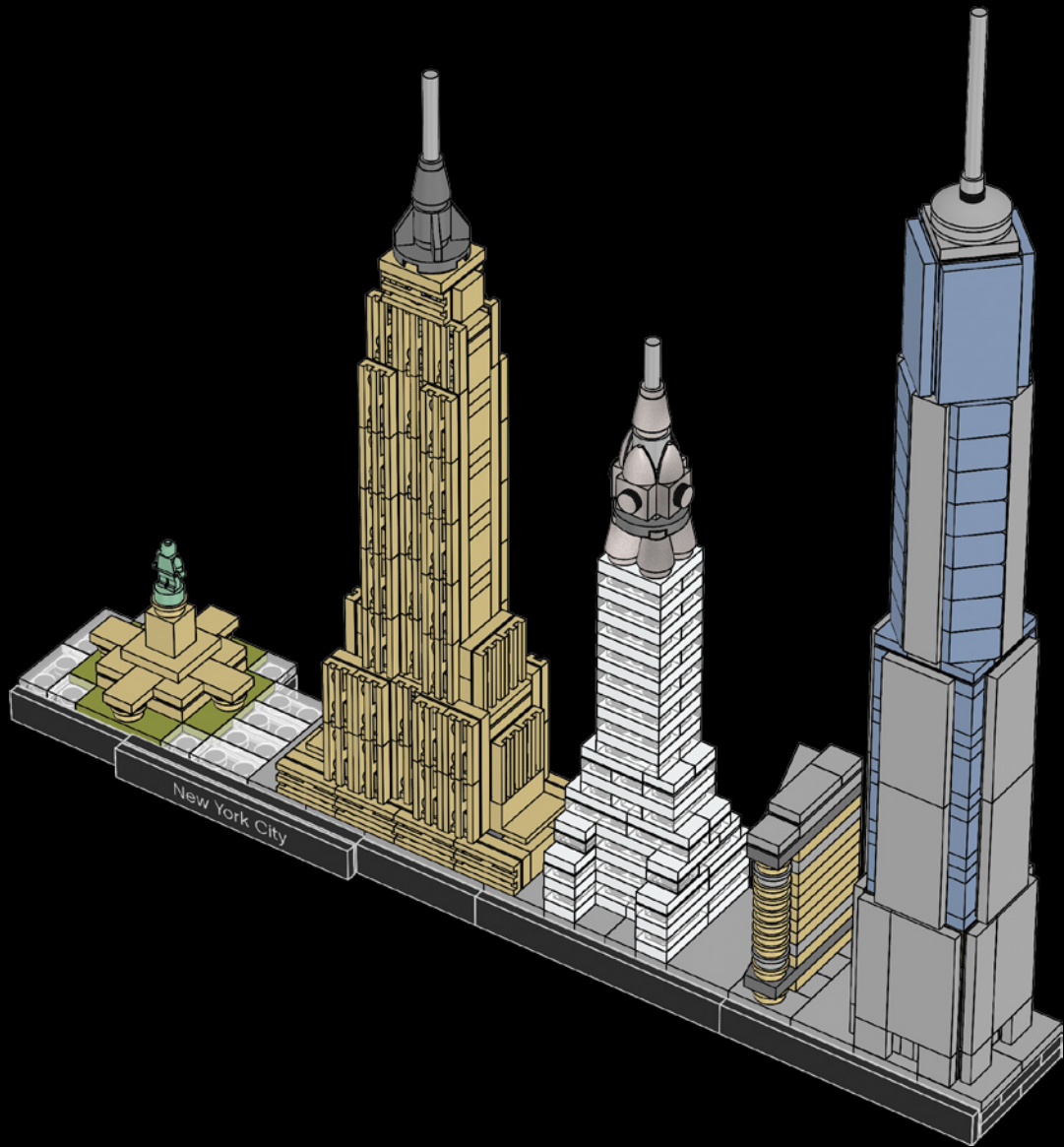



RAISING A BABY IN
AN NYC APARTMENT
IS LIKE GROWING
AN OAK TREE IN A
THIMBLE. Available
for rent only
211-storage
STORAGE from \$29 FREE MOVE!

PARK
FREE

LEGO® Architecture—then and now

There has always been a natural connection between the LEGO® brick and the world of architecture. Fans who build with LEGO elements instinctively develop an interest in the form and function of the structures they create. At the same time, many architects have discovered that LEGO bricks are the perfect way of physically expressing their creative ideas.

This connection was confirmed in the early 1960s with the launch of the LEGO 'Scale Model' line. It matched the spirit of the age where modern architects were redefining how houses look and people were taking an active interest in the design of their new homes. These sets were designed to be different from the normal, brightly colored LEGO boxes; they also included a book on architecture as a source of inspiration.

Decades later, architect and LEGO fan Adam Reed Tucker revived the idea of expressing architecture using LEGO bricks and in partnership with the LEGO

Group, launched the LEGO Architecture line that we know today. His first models, and the original sets in the current LEGO Architecture series, were interpretations of famous skyscrapers from his hometown of Chicago. Since then LEGO Architecture has developed and evolved, first with well-known buildings from other cities in the United States, and now with iconic structures from Europe, the Middle East and Asia.

The introduction of our LEGO Architecture Studio set echoes the ambitions of the earlier LEGO 'Scale Model' line and widens the potential of the LEGO Architecture series. Now you can enjoy building and learning about specific landmark buildings, or create exciting architectural models from your own fantasy. An inspiring 270-page book, featuring a number of renowned architects from around the world, guides you through the principles of architecture and encourages you in your own creative building.



21050
Studio

Celebrate the world of architecture

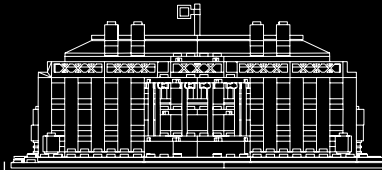

21006
The White House

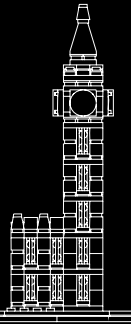

21013
Big Ben

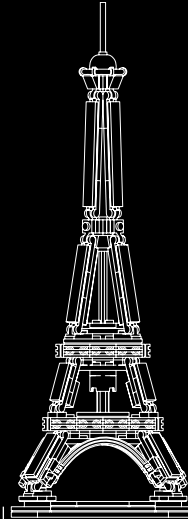

21019
The Eiffel Tower

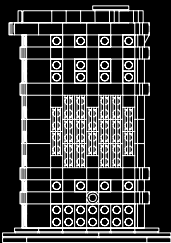

21023
Flatiron Building



21024
Louvre

and collect all the models



21020
Trevi Fountain

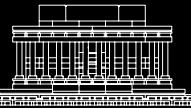

21022
Lincoln Memorial



21027
Berlin

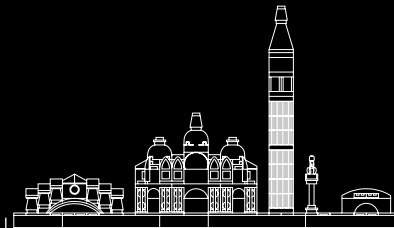

21026
Venice

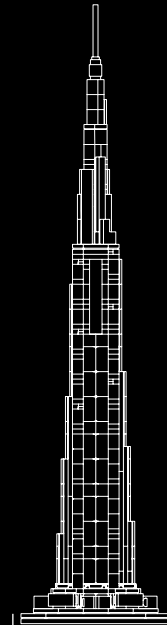

21031
Burj Khalifa

References

Photo Credits -

© Shutterstock

© Chrysler Building

© Empire State Realty Trust, Inc.

© Everett Historical

Text -

www.nycgo.com

www.wtc.com

www.esbnyc.com

www.nps.gov

www.flatirondistrict.nyc

Customer Service
Kundenservice
Service Consommateurs
Servicio Al Consumidor
LEGO.com/service or dial



00800 5346 5555 :



1-800-422-5346 :



6x
4558952

4x
307001

12x
6051511

4x
242001

12x
302201

1x
302101

2x
371001

1x
395701

14x
4161734

22x
4159553

5x
4113915

8x
4125253

16x
421356

9x
6138230

74x
4124456

6x
4114026

3x
6092587

2x
4124460

12x
6024495

4x
4113917

2x
4565387

3x
4114084

11x
4121921

5x
4118790

4x
4114309

2x
4114324

4x
4143409

16x
4143005

1x
6050850

16x
654124

4x
302324

2x
302426

7x
302326

2x
4225201

3x
302226

2x
242026

1x
6052126

2x
362326

2x
243126

2x
371026

1x
302026

1x
4569407

4x
4653049

2x
416226

4x
346026

1x
6135412

3x
303426

6x
6047501

42x
4167842

6x
4569297

4x
6138232

16x
4620077

32x
6139519

19x
6142245

4x
6124349

1x
6138781

4x
4211412

2x
4211525

14x
4211415

5x
4211511

4x
4594238

3x
4211791

4x
4657459

2x
4211512

10x
6066097

5x
4211414

1x
6126082

2x
6065824

6x
4211429

2x
6116608

8x
4211356

2x
4211445

1x
6015347

16x
4560183

2x
6081975

1x
4211452

4x
4211481

4x
4211425

1x
4529240

12x
4558955

1x
4212352

2x
4210782

2x
4211042

2x
6115080

6x
6000606

5x
6121350

4x
4625146

4x
6046903

1x
4654448

2x
6001494

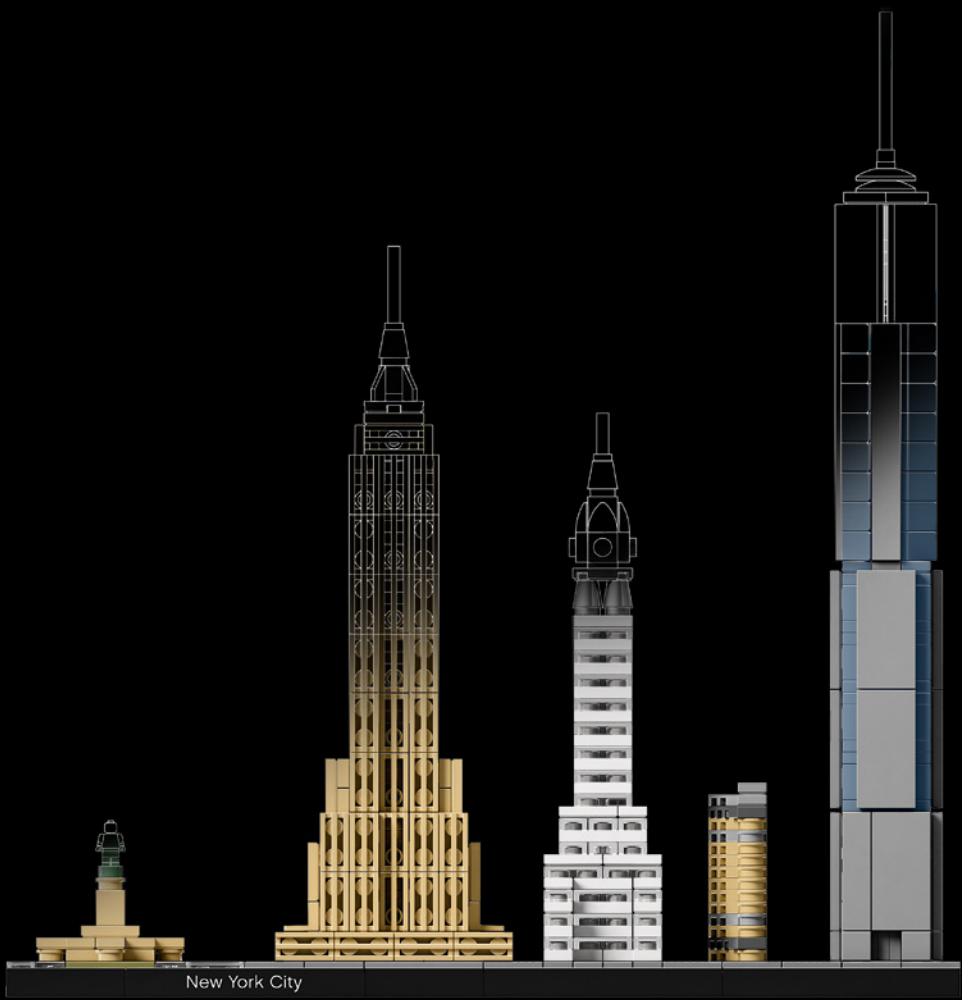

New York City

LEGO and the LEGO logo are trademarks of the LEGO Group.
©2016 The LEGO Group. 6285432
One World Trade Center building design is a copyright of WTC Tower I LLC.
Used under license.

The Empire State Building image® is a registered trademark of ESRT Empire State Building, L.L.C. and is used with permission.

