

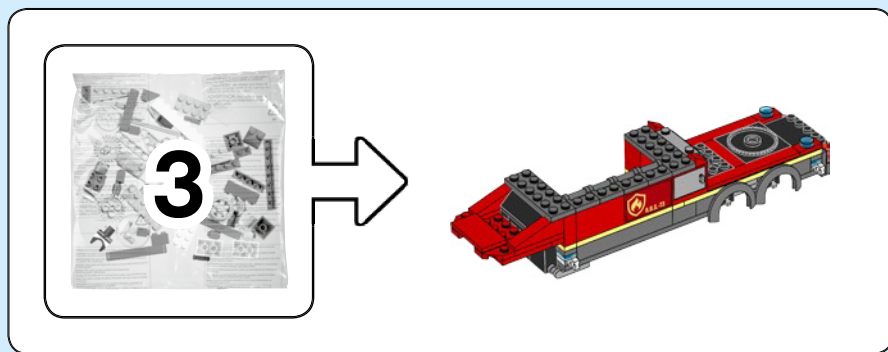

# CITY

60216





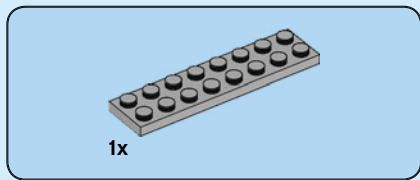
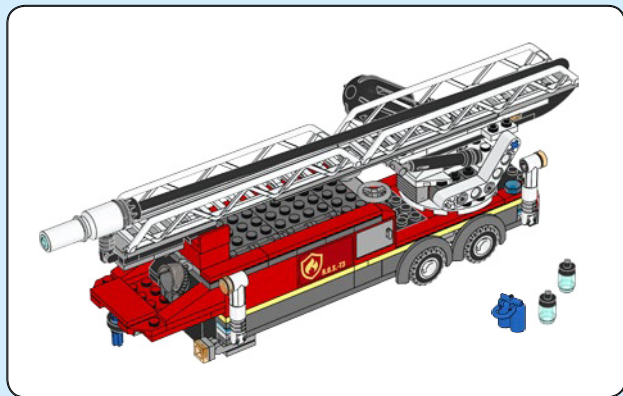

1

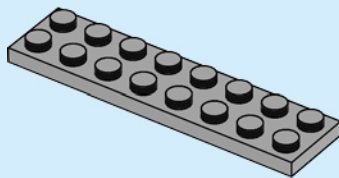

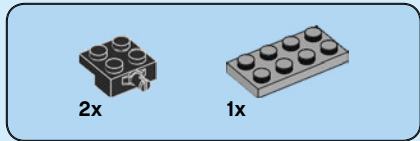

2

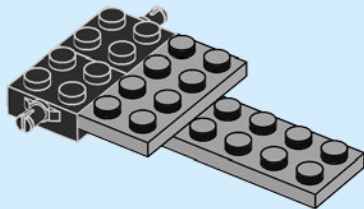

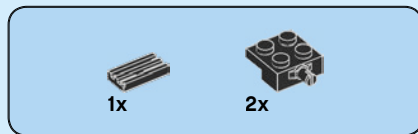

3

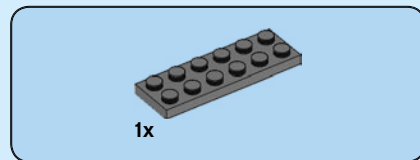
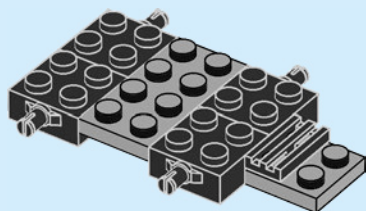

4

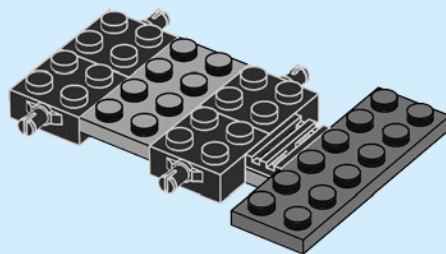

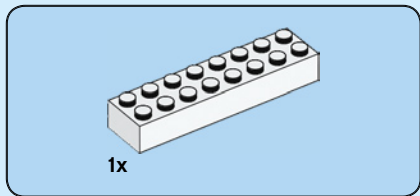

5

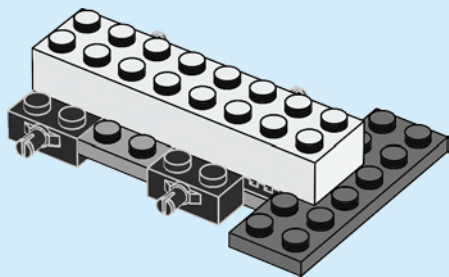

6

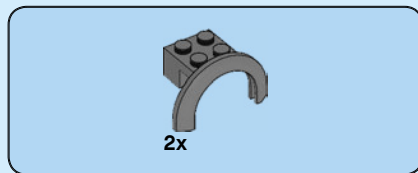

6

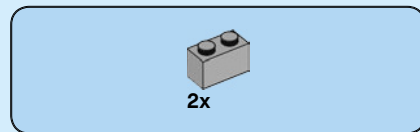
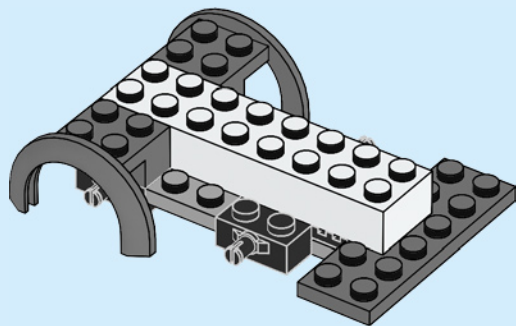

7

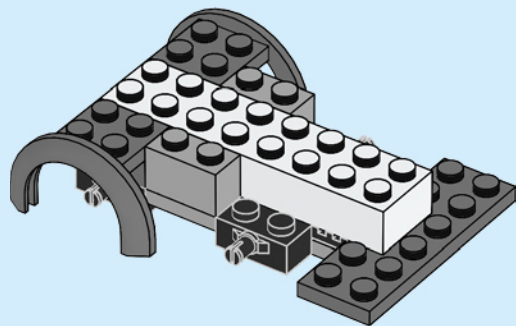



2x

8

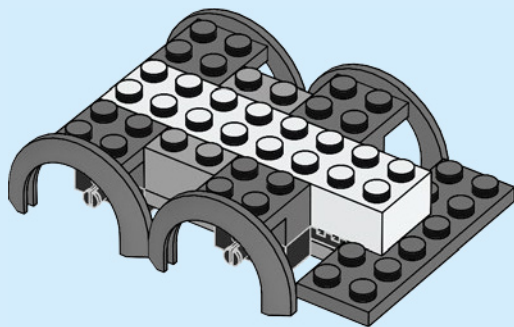

8





2x



1x

9

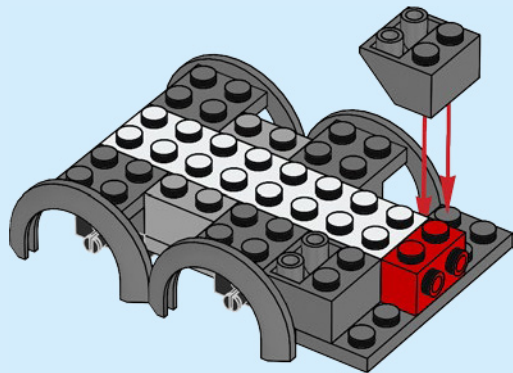

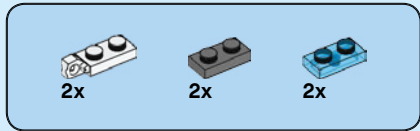

10

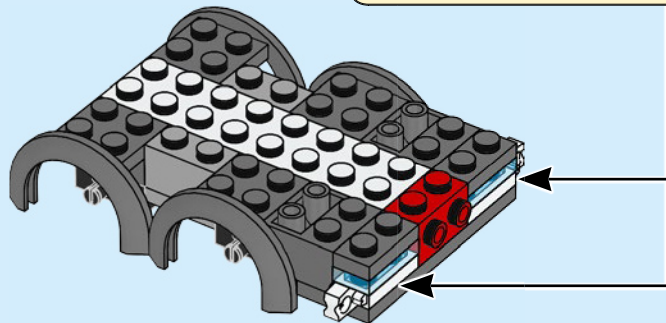
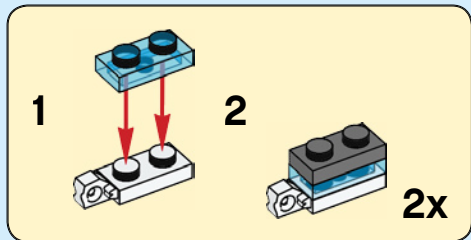

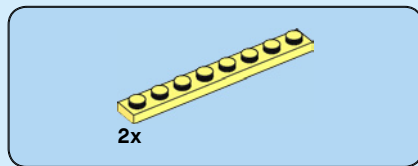

11

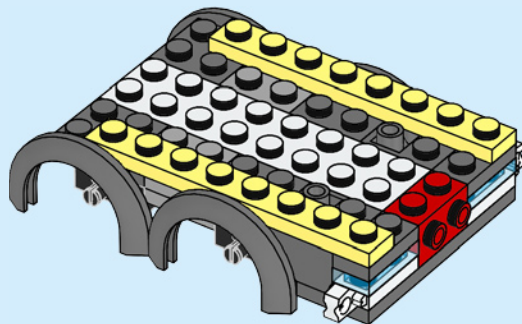

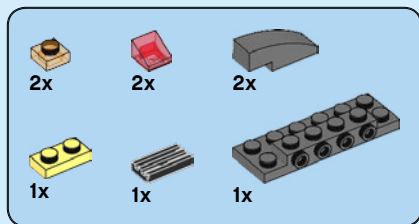

# 12

1

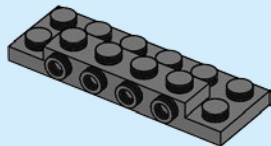

2

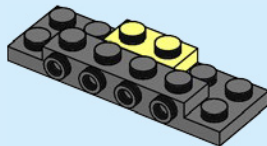

3

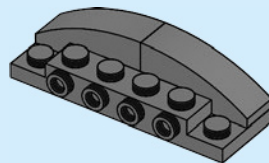

4

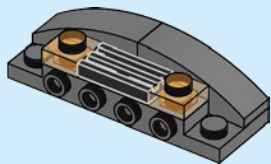

5

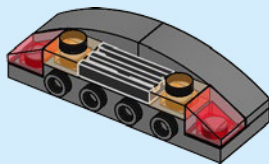

6

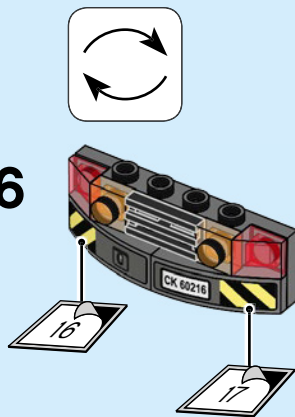

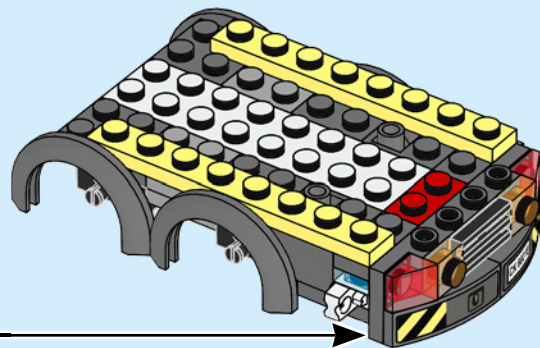

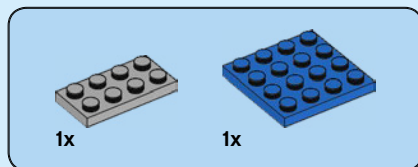

13

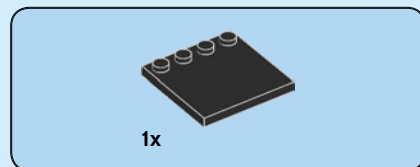
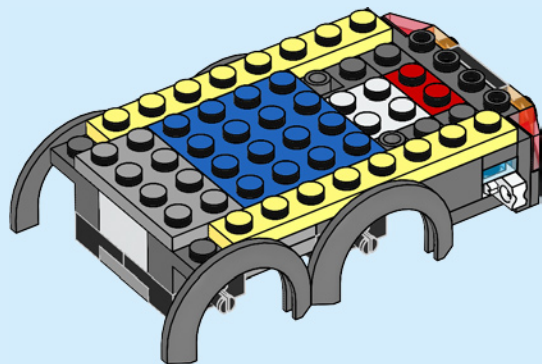

14

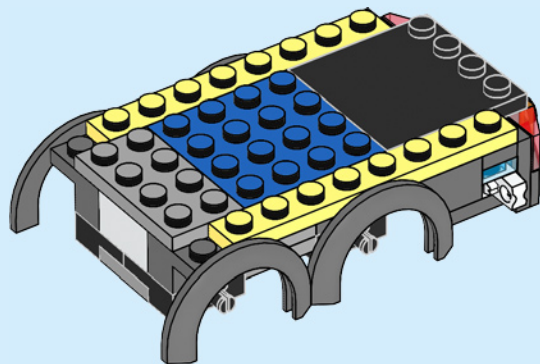

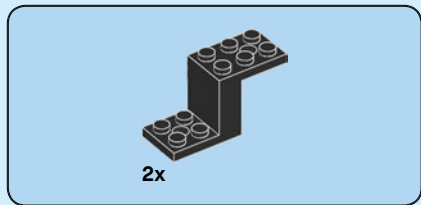

15

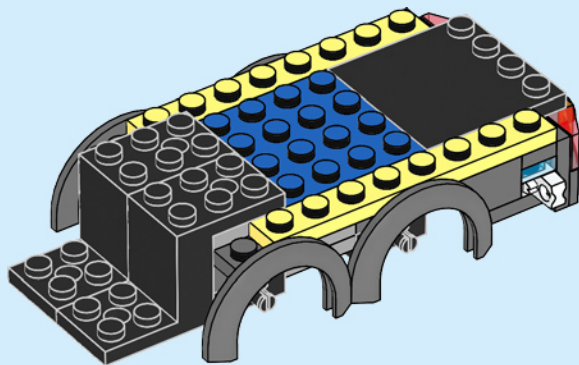

16



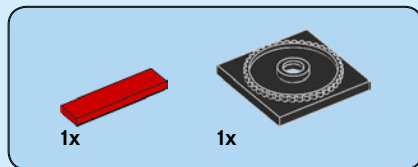

16

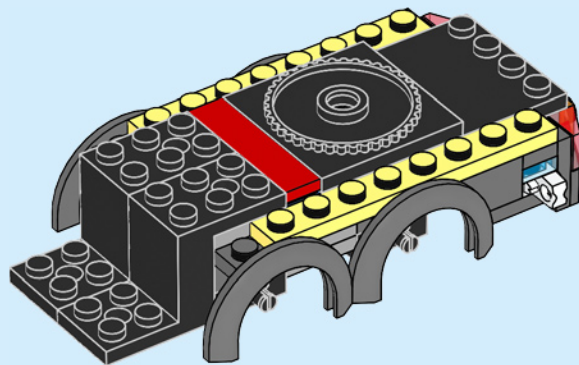

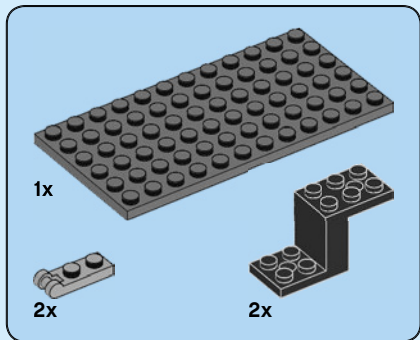
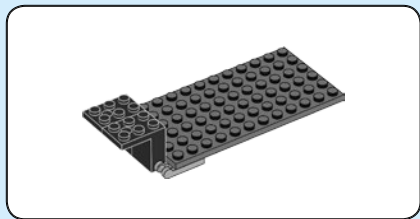

17

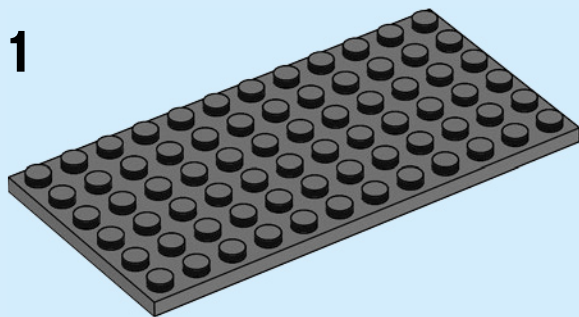

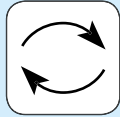

2

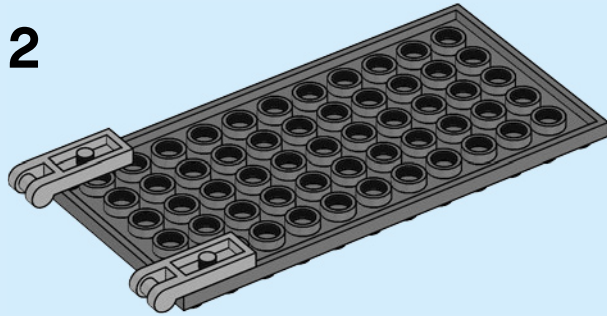

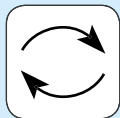

**3**

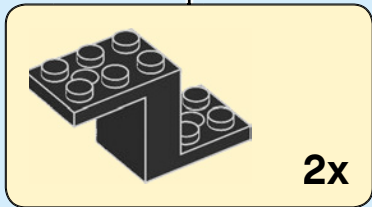
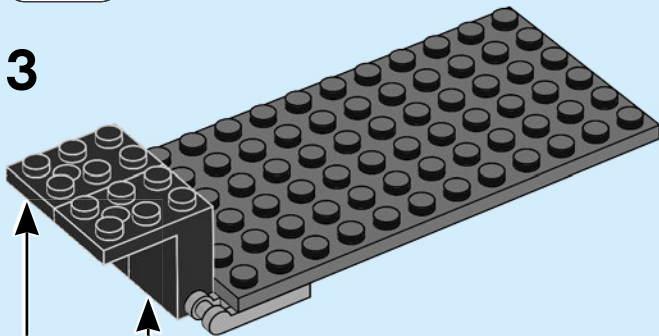

**2x**

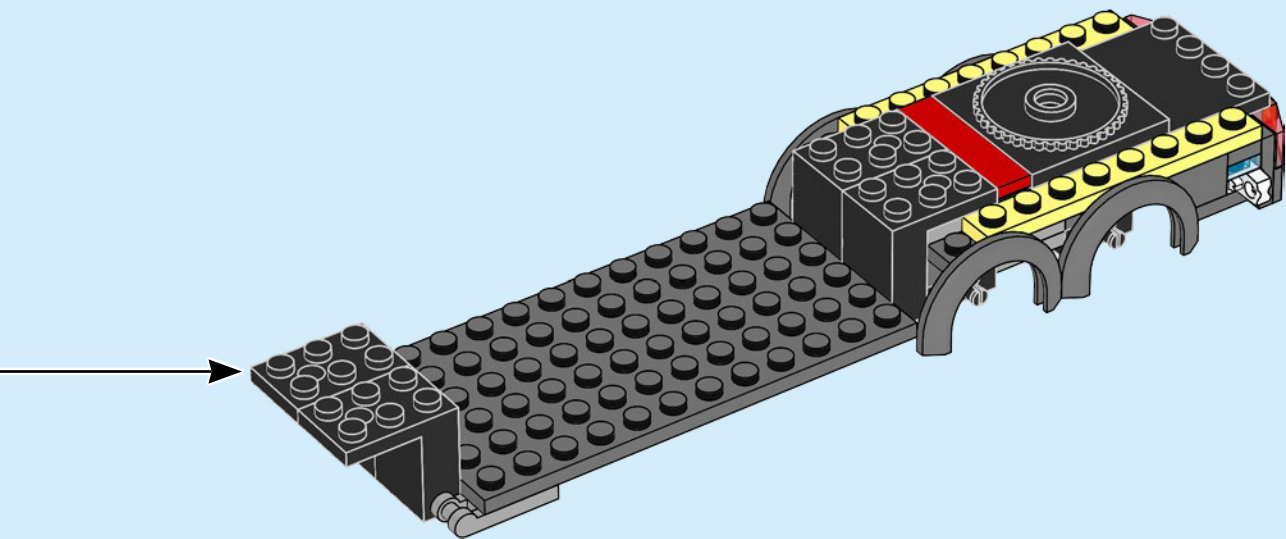

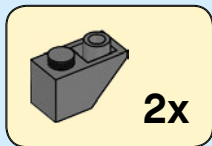
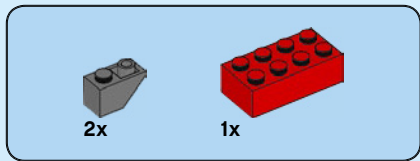

18

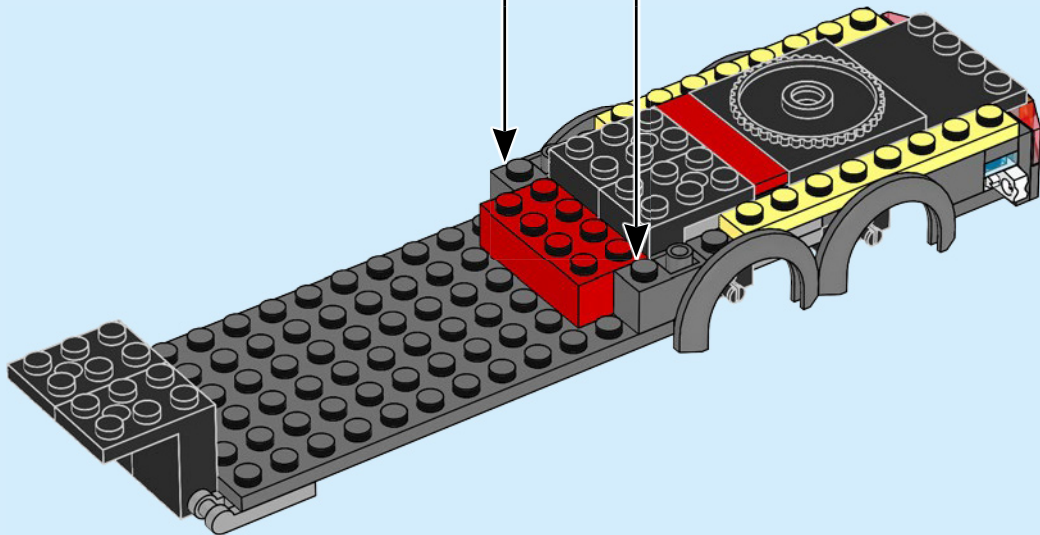



2x

19

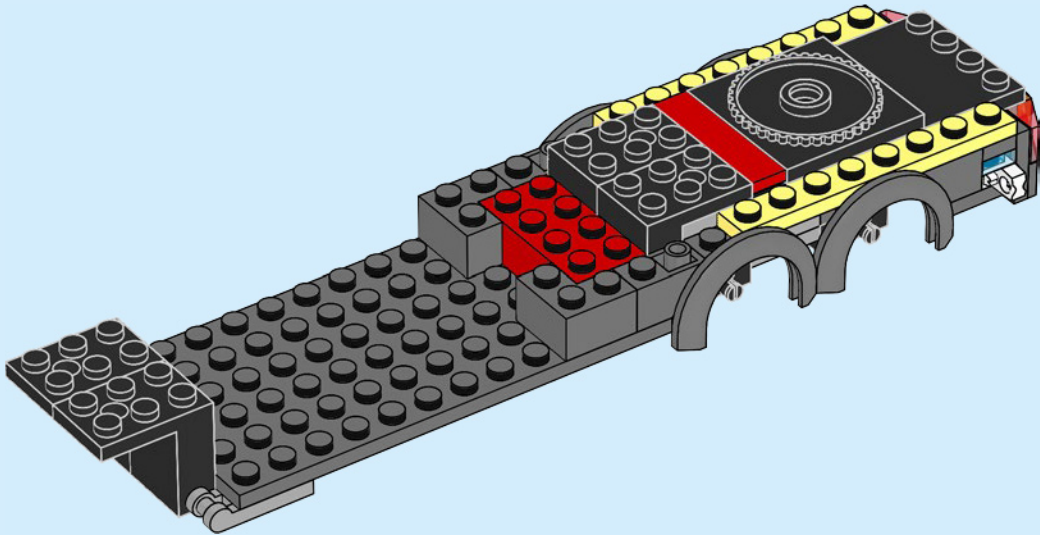

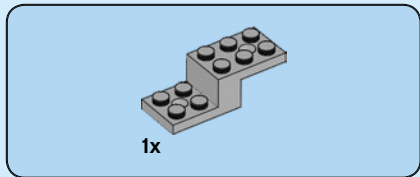

20

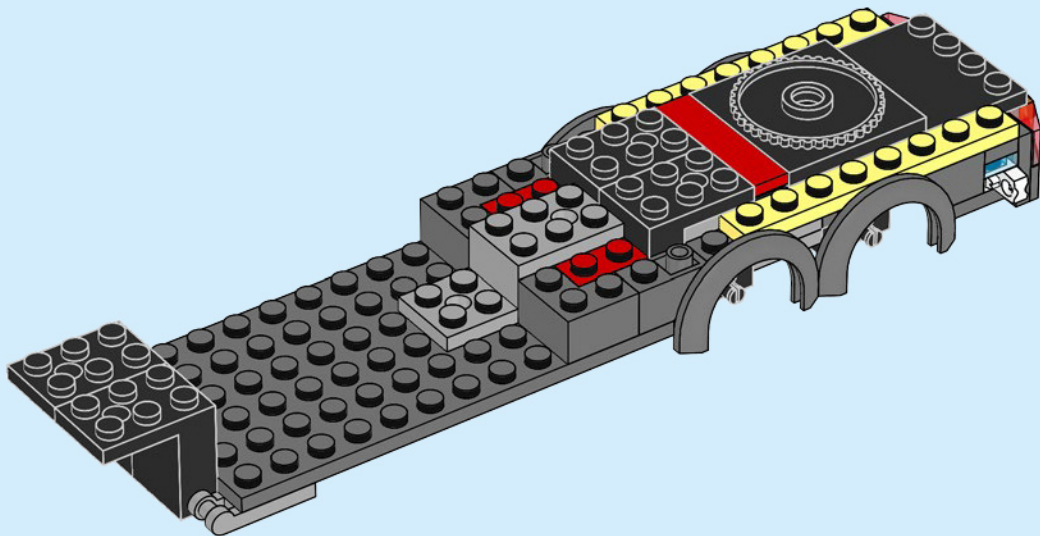

24



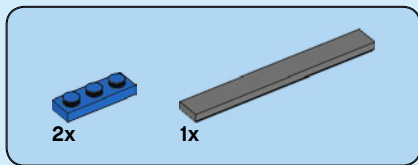

21

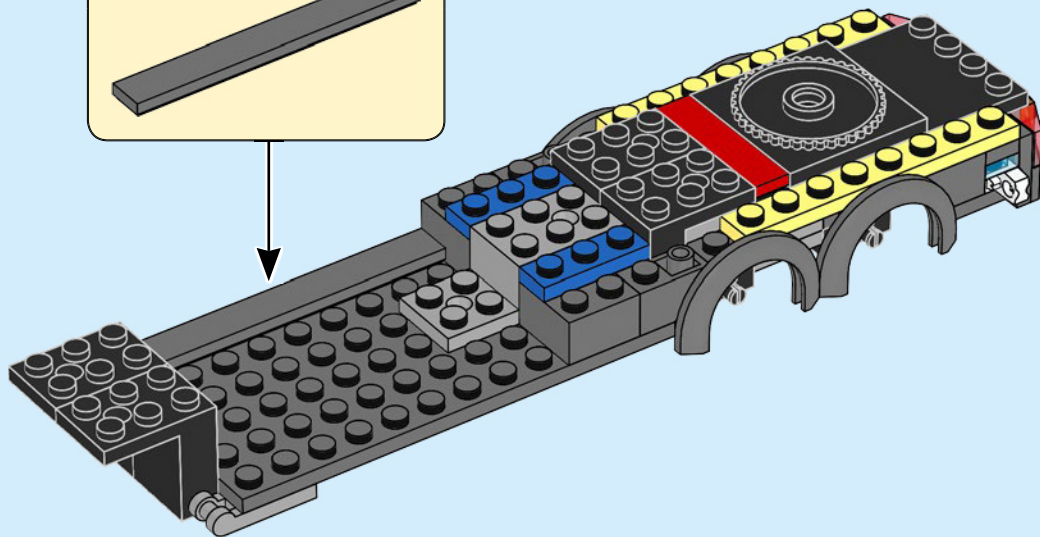
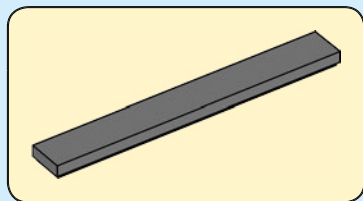

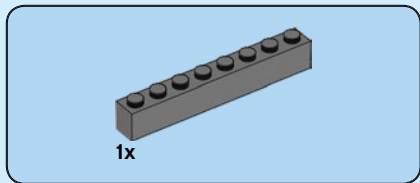

22

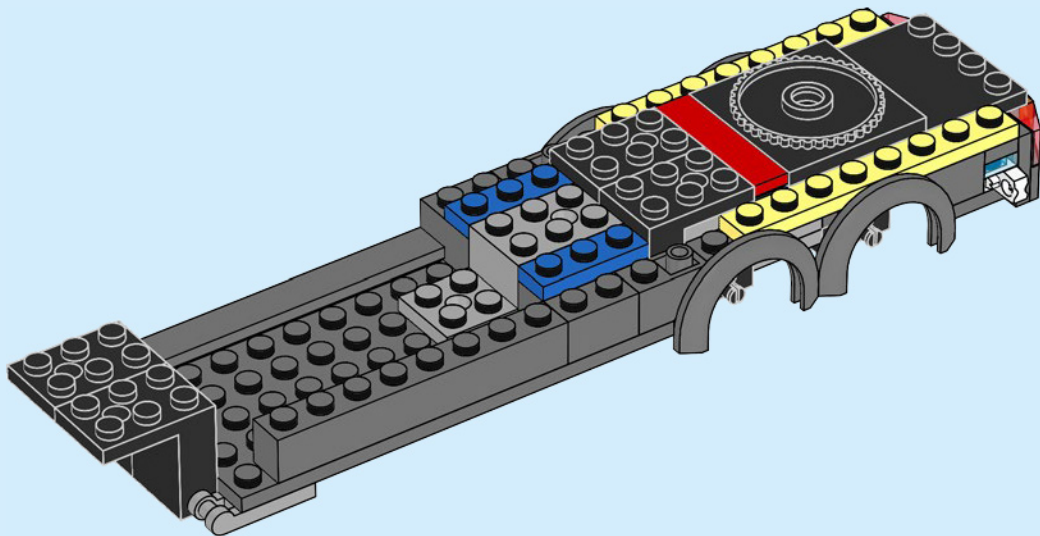



2x



2x



2x

# 23

1

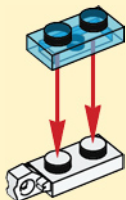

2

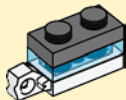

2x

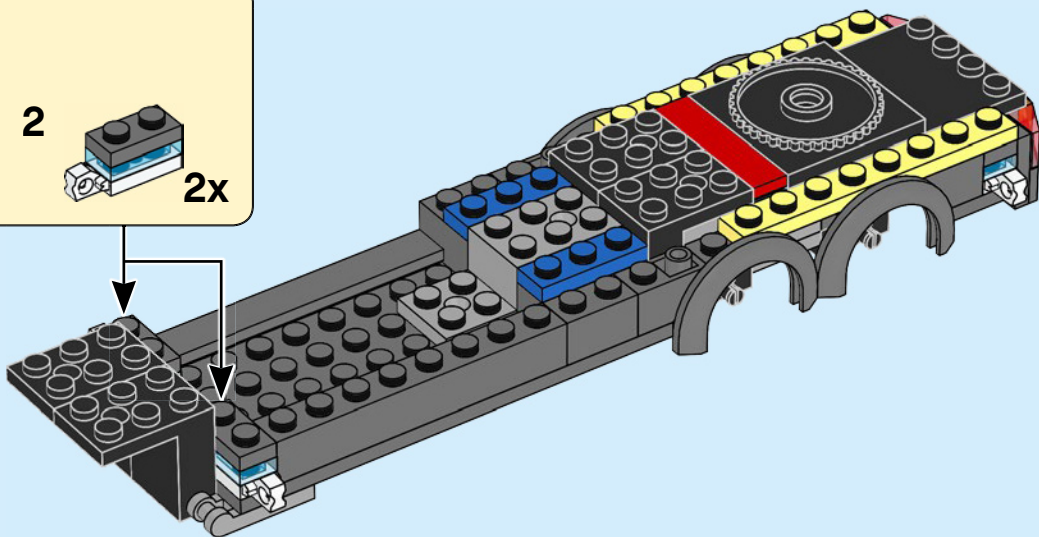



2x



2x

# 24

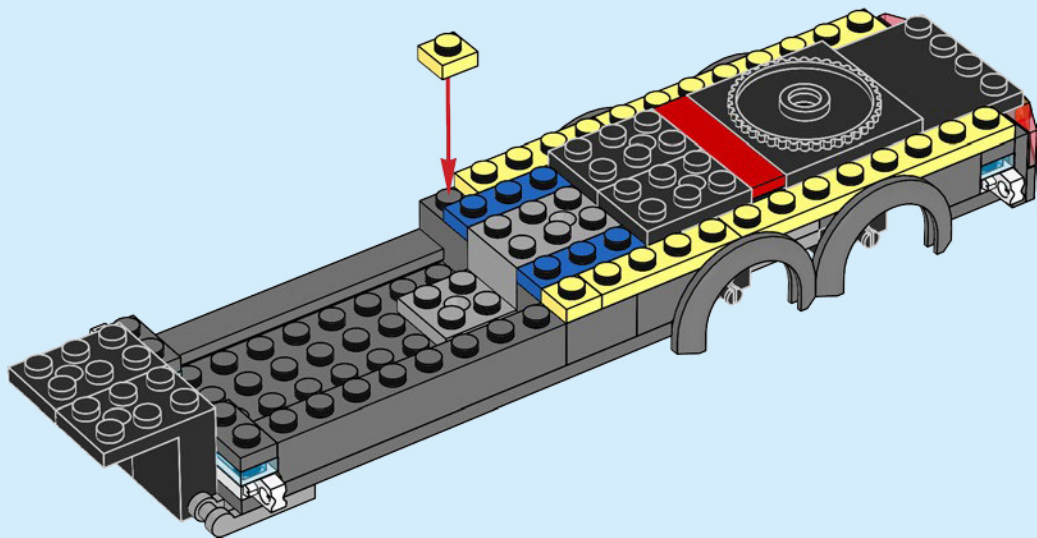

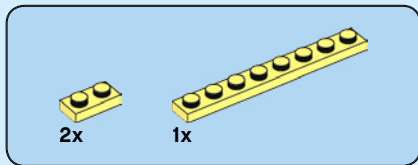

25

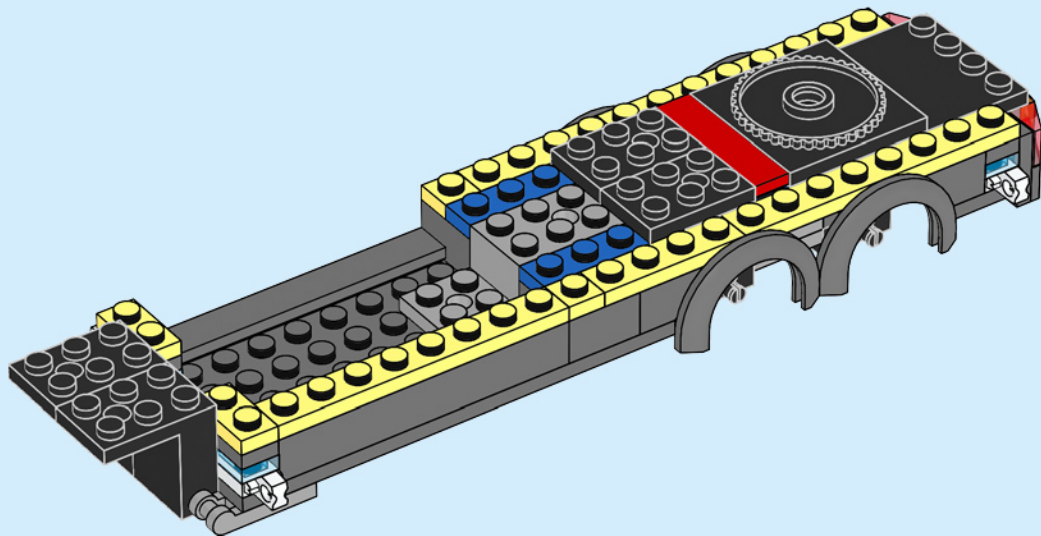

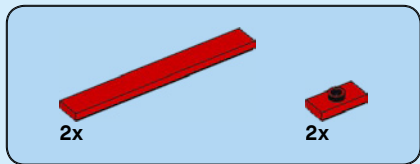

26

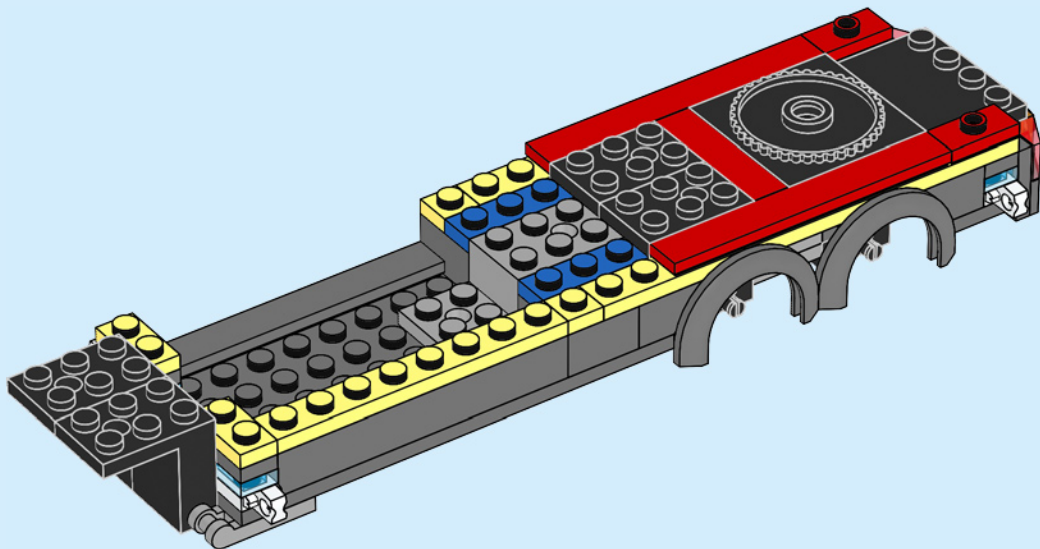



1x



1x

27

1

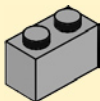

2

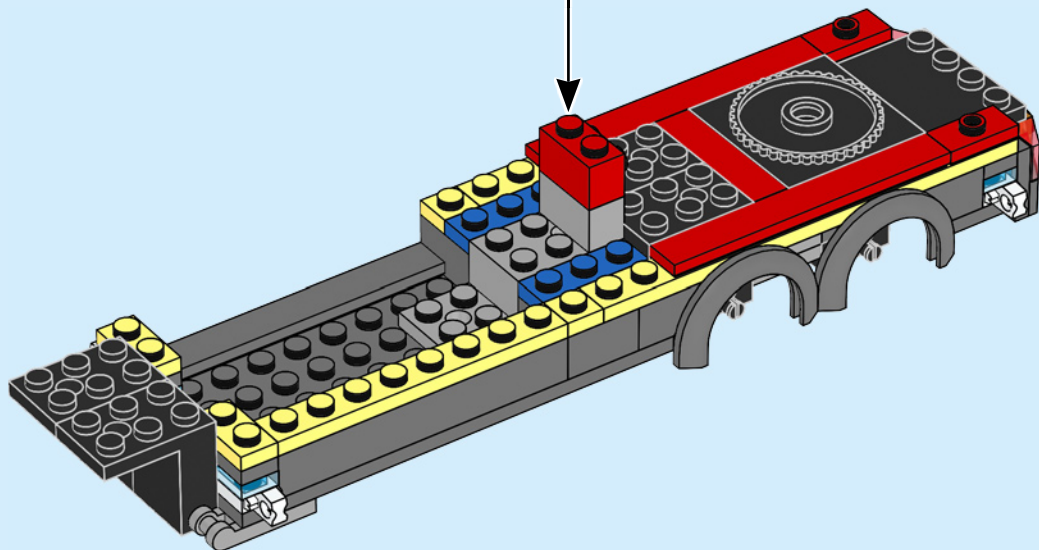
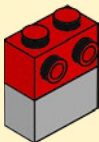

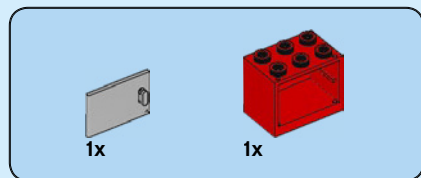

28

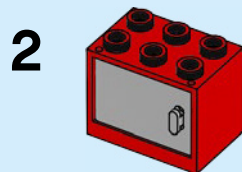
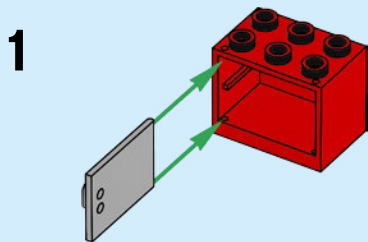



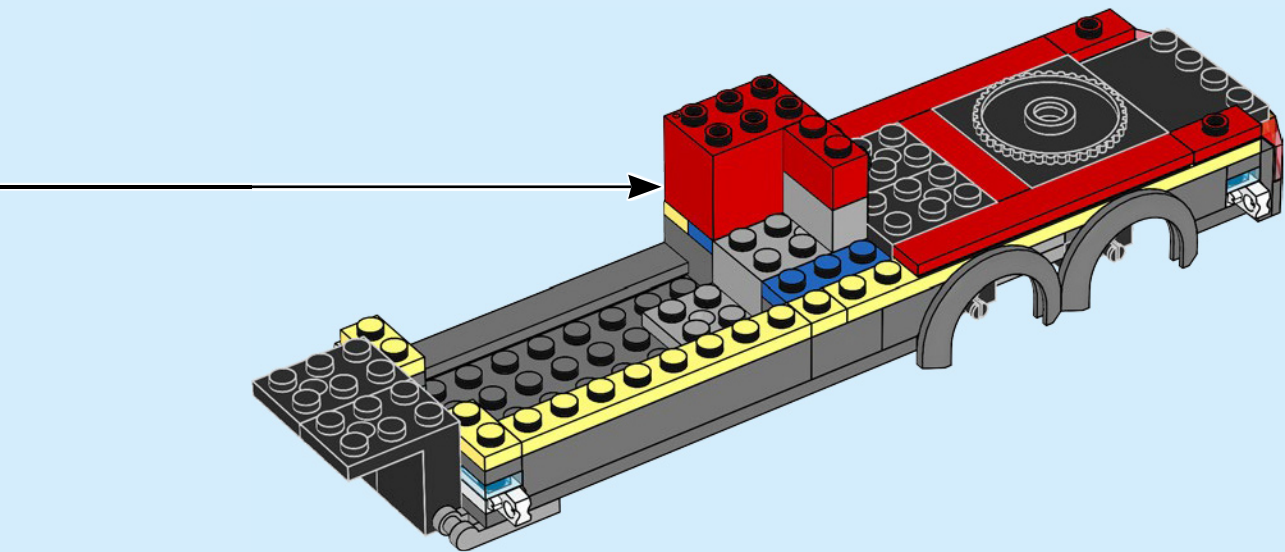

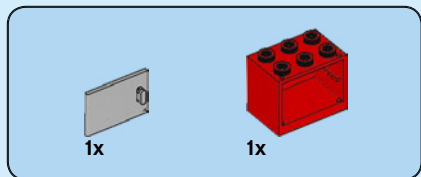

29

1

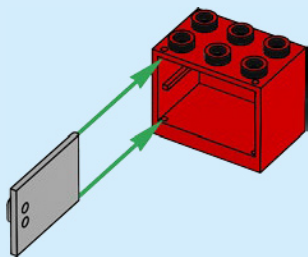

2

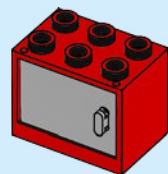

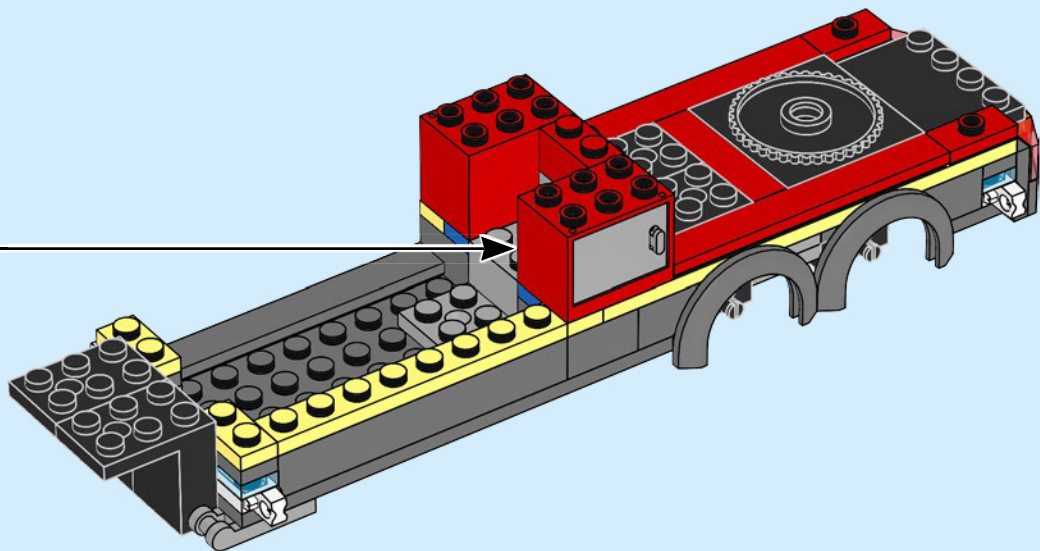



2x

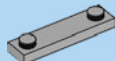

1x

# 30

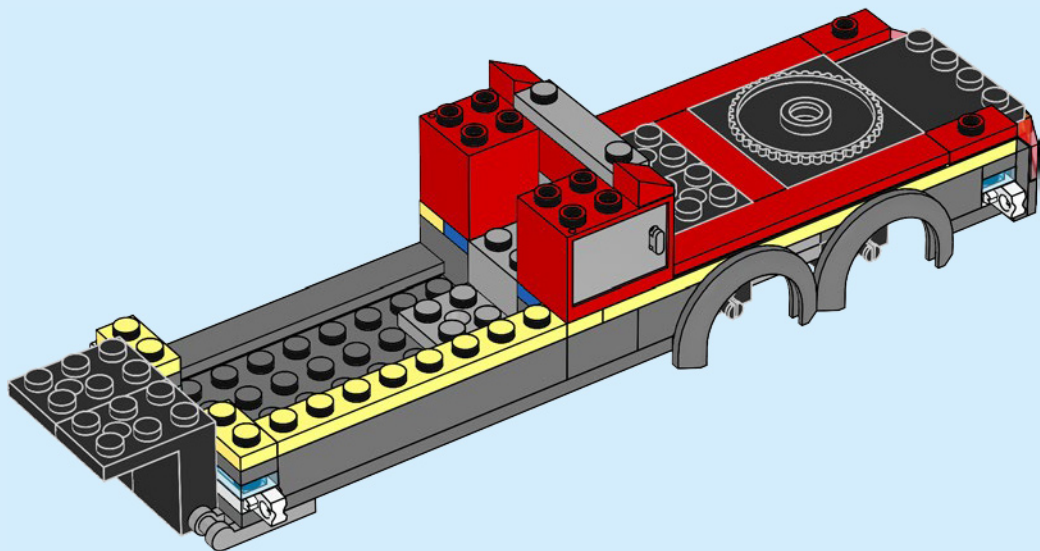

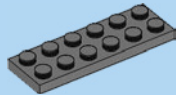

1x

31

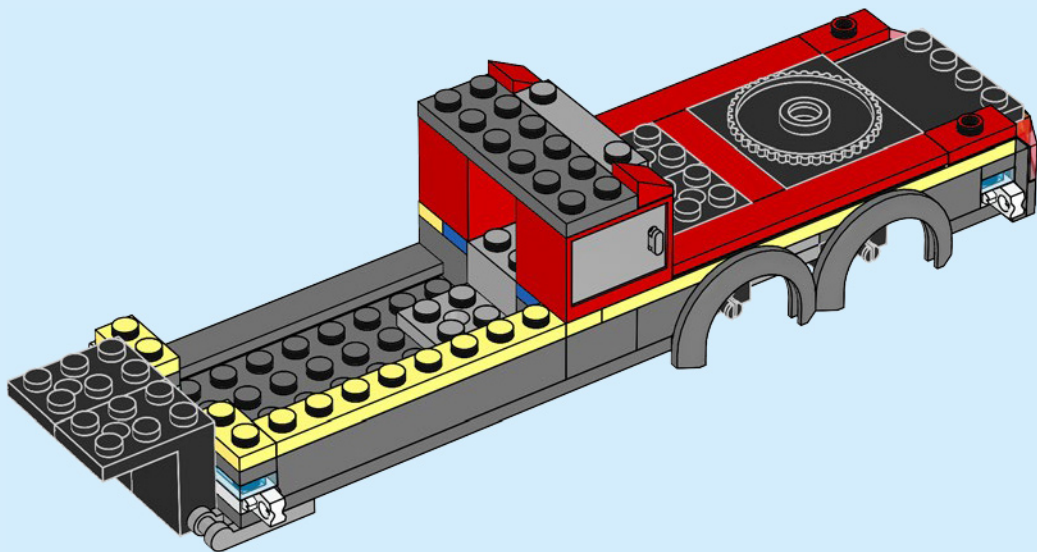

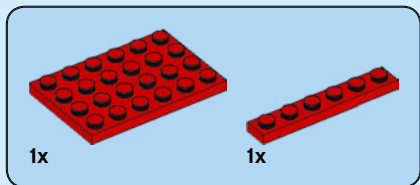

**32**

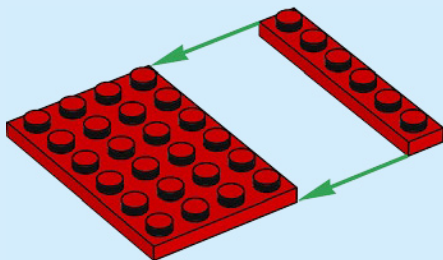



2x



2x

**33**

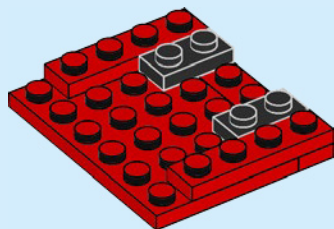



2x

34

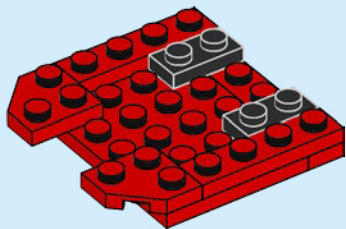



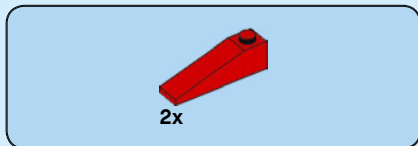

35

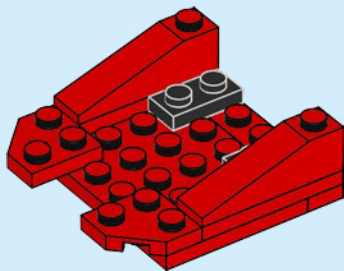



1x

36

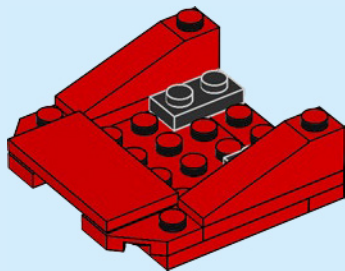

37

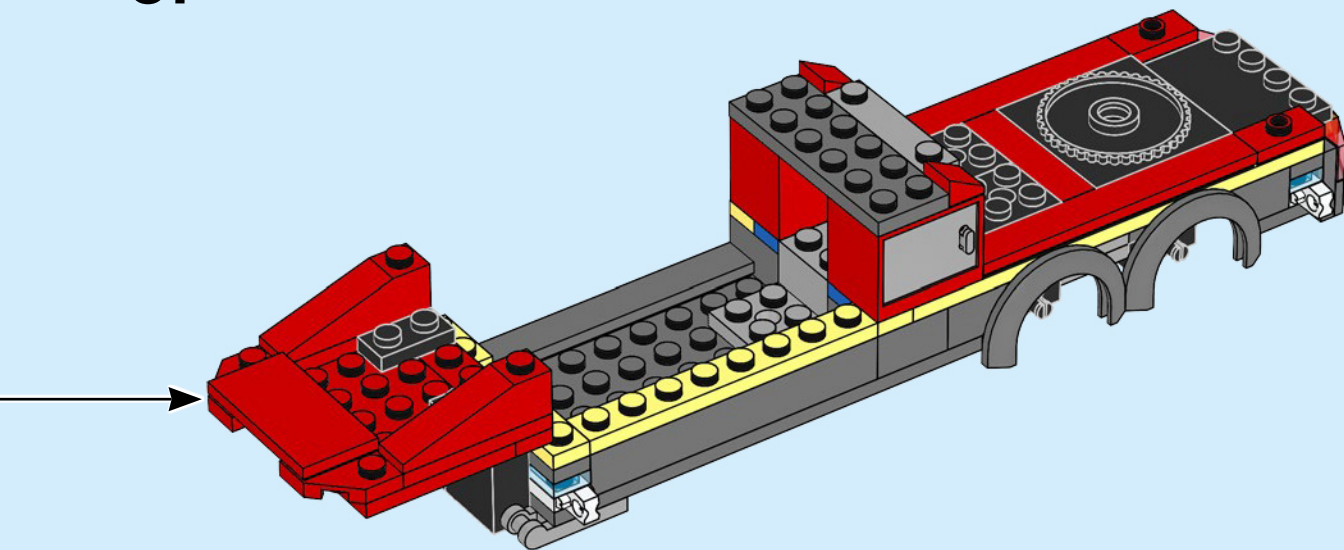

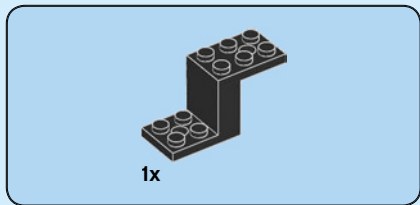

38

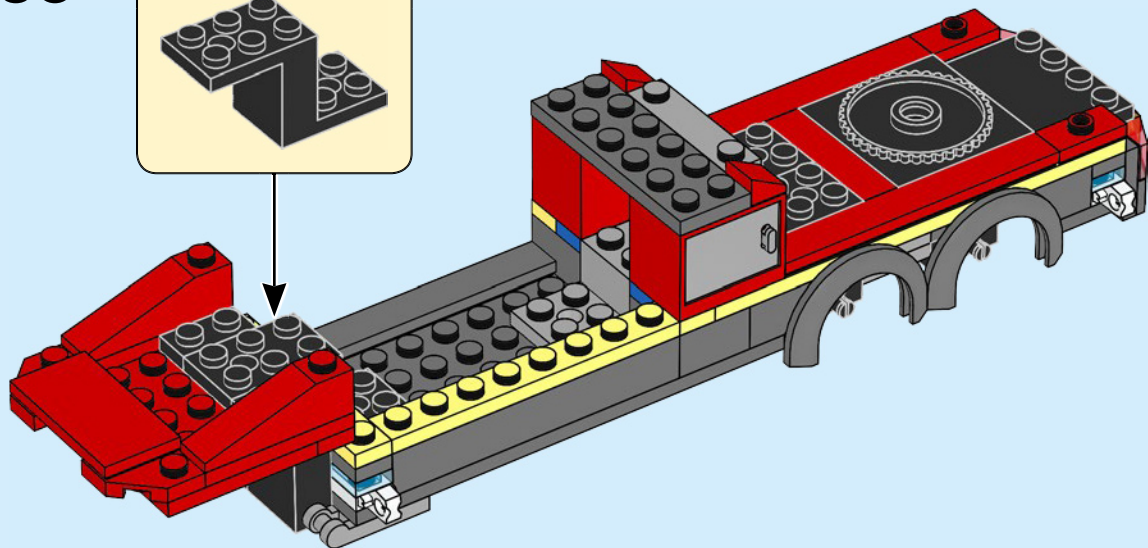
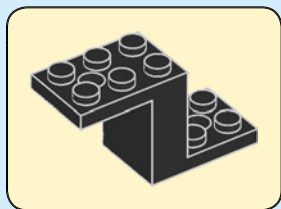

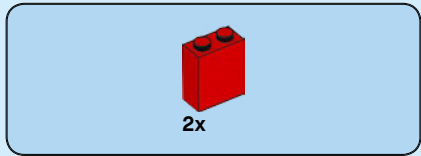

39

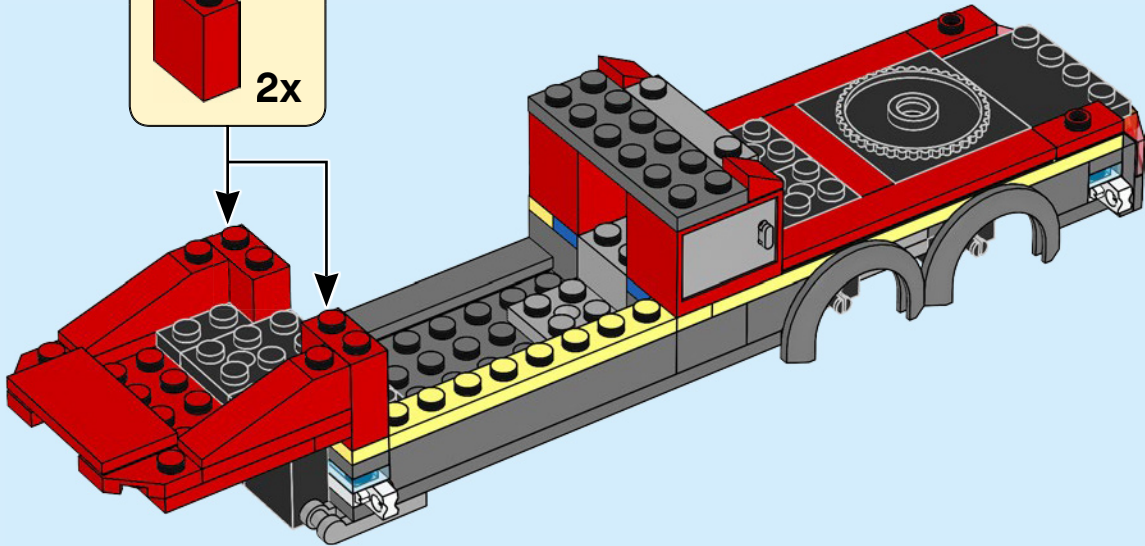
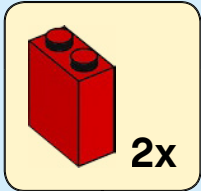

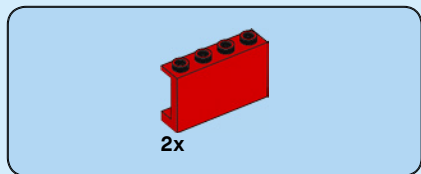

40

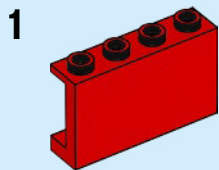

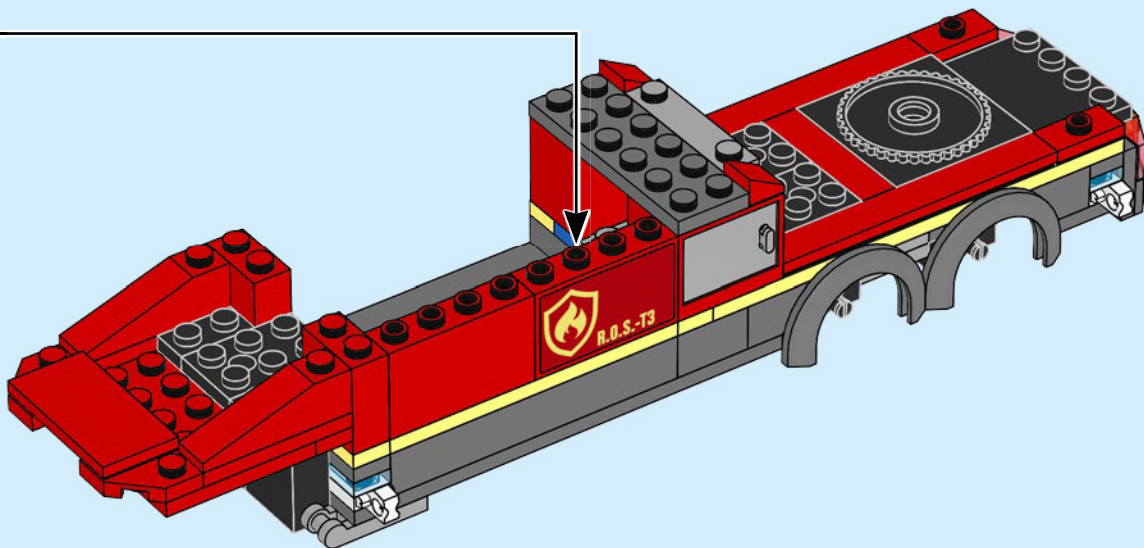

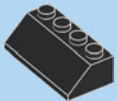

1x

41

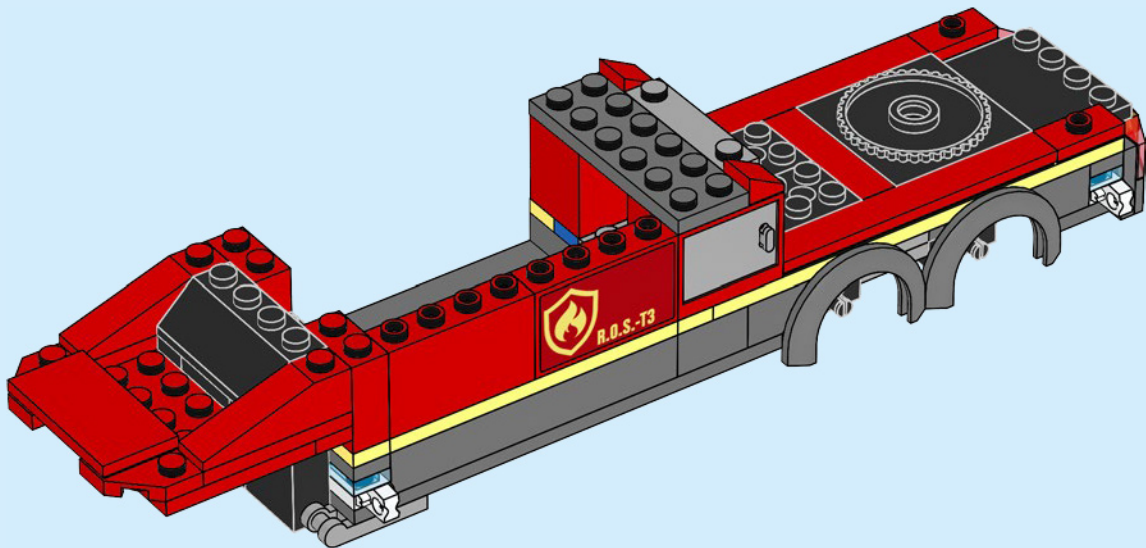

48



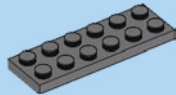

1x

42

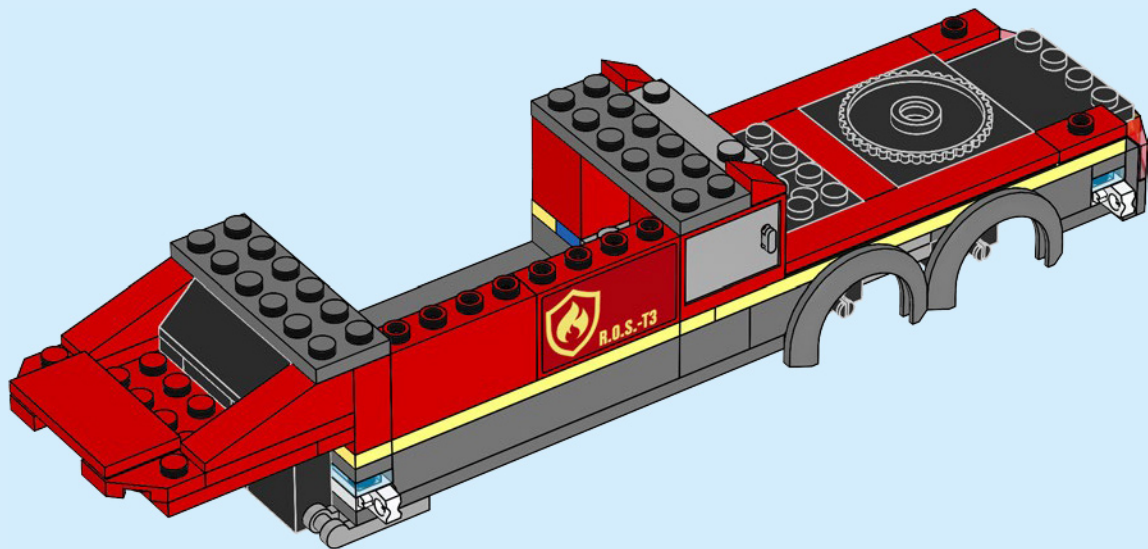



4x

43

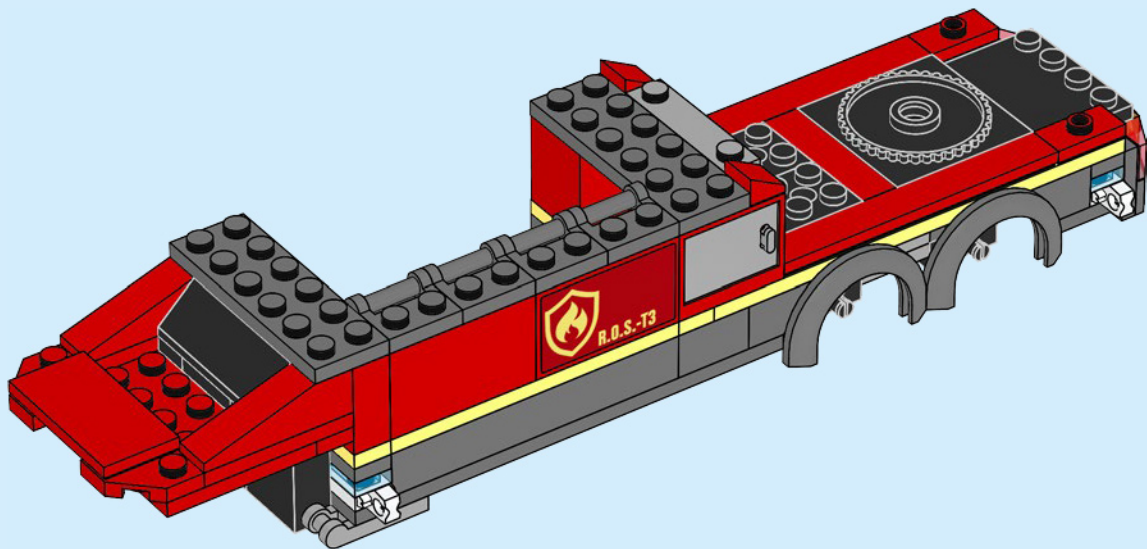

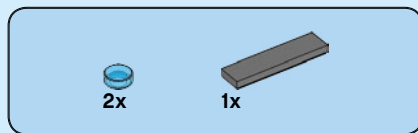

44

