

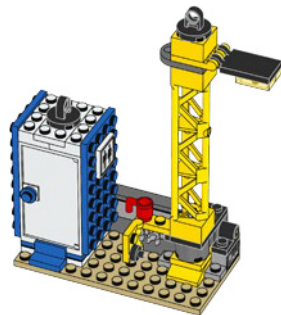

# CITY

60216

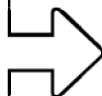

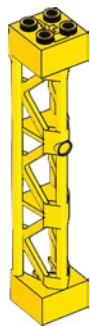
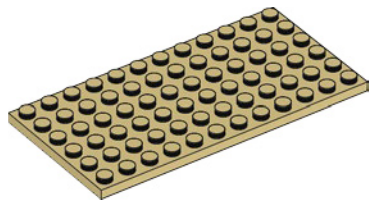

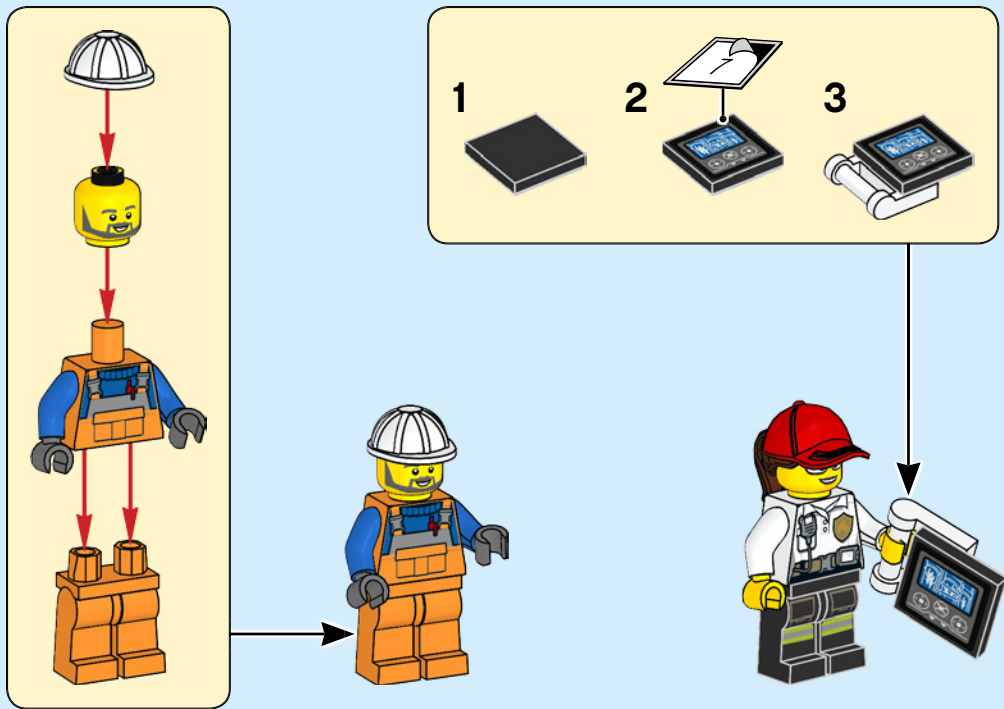

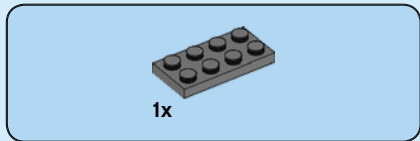
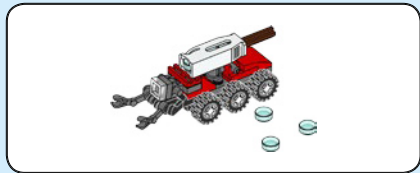

1

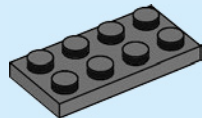



1x

2



2x

3

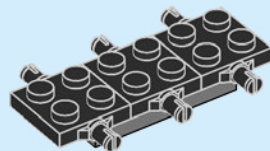



1x

4

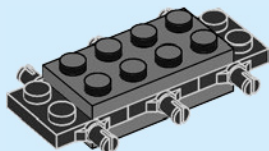

6



1x



1x

5

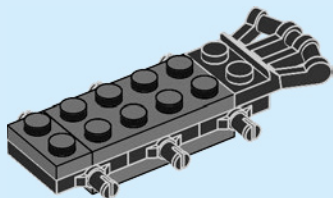

2x

6

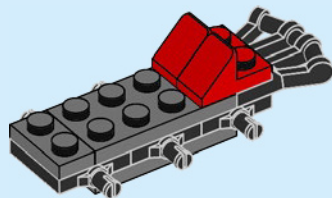



1x

7

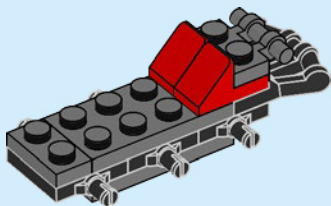

8





1x

8

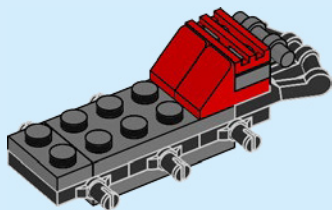

2x

9

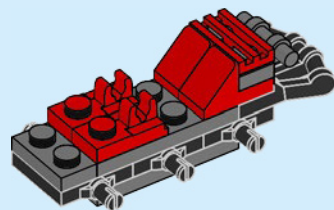



1x

10

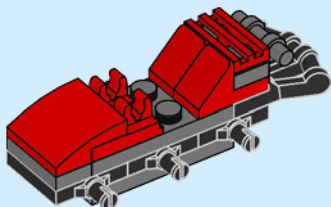



1x

11

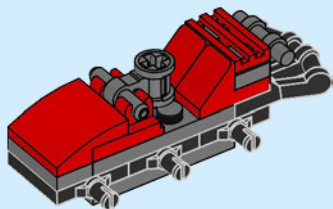

2x

12

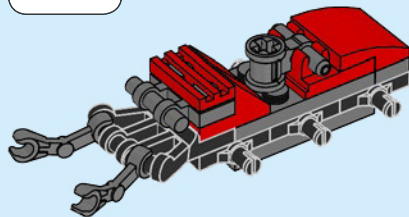
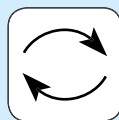



1x



1x

# 13

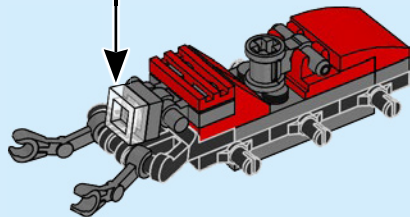
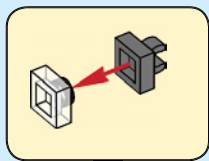



6x



6x

# 14

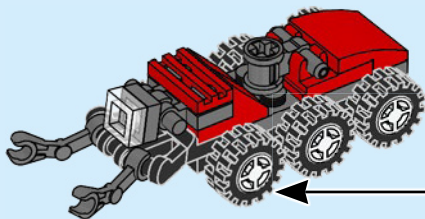

6x

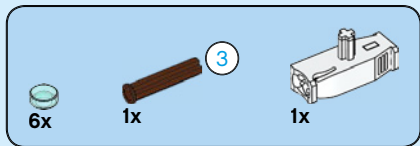
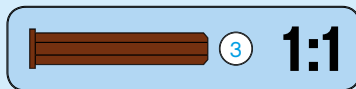
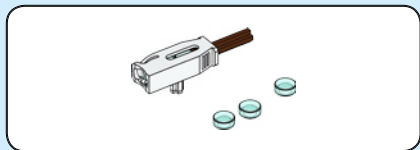

15

1

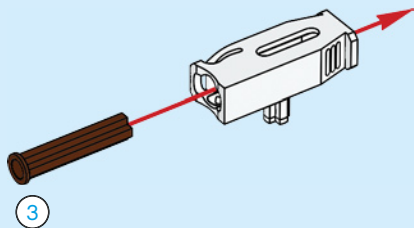

2

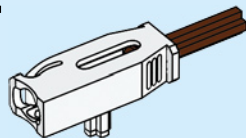

3

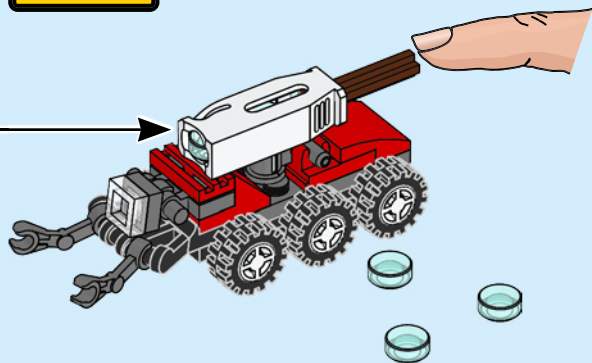
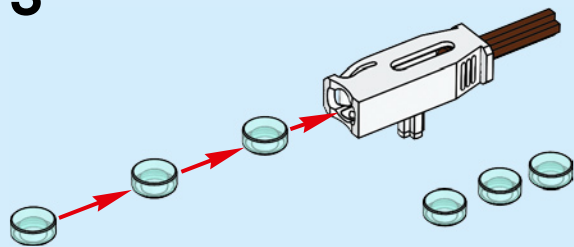

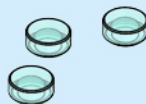
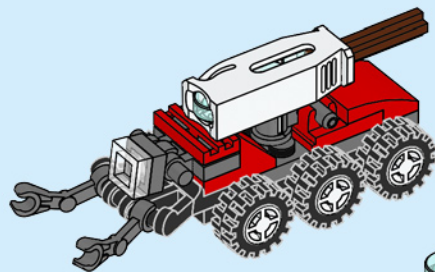
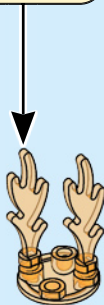
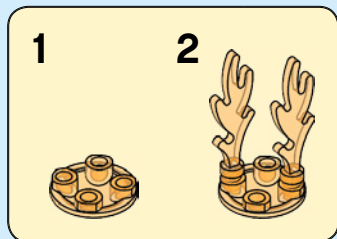



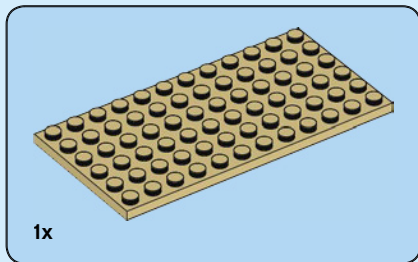

1x

**1**

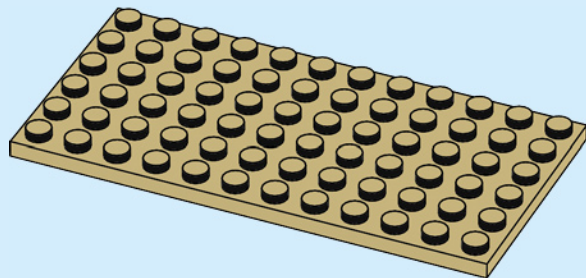

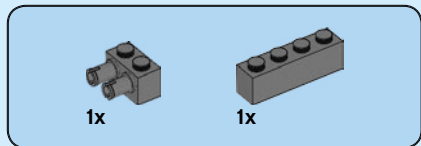

2

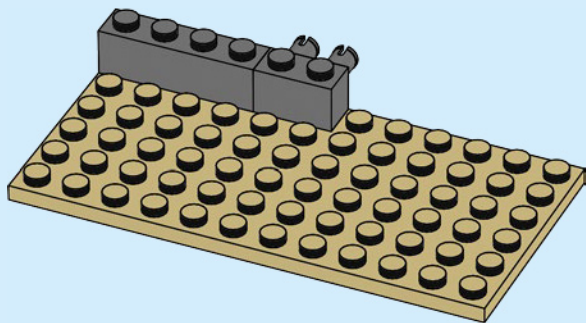

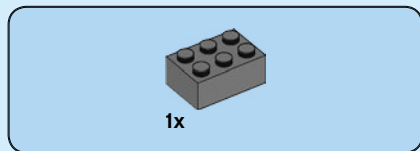

3

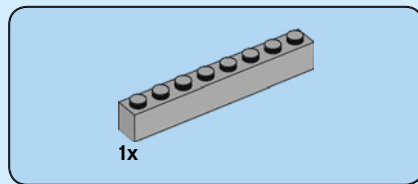
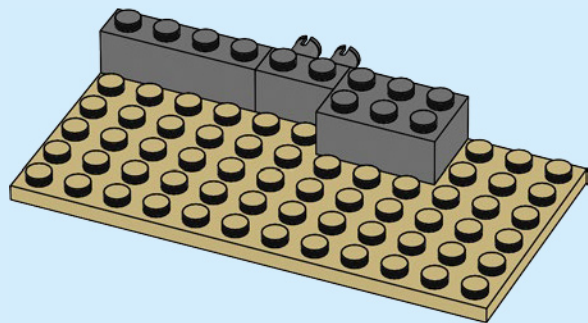

4

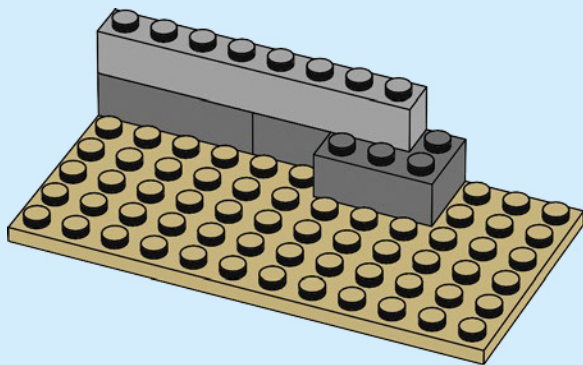

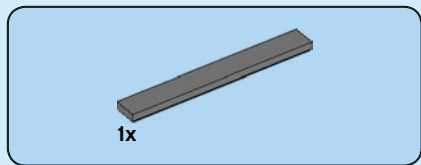

5

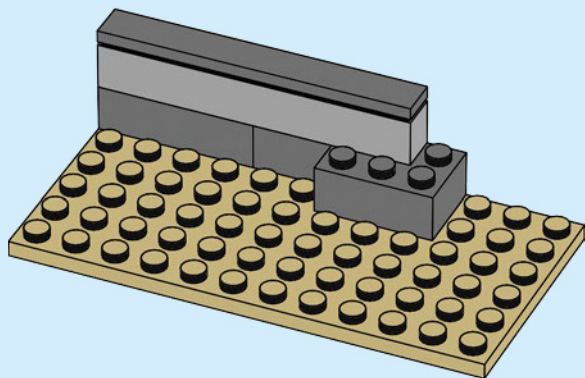

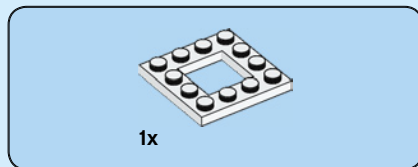

6

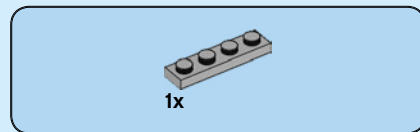
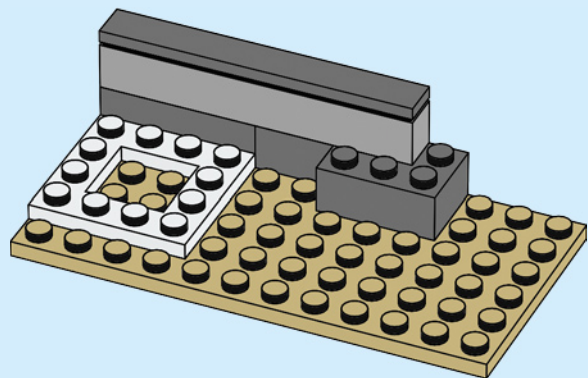

7

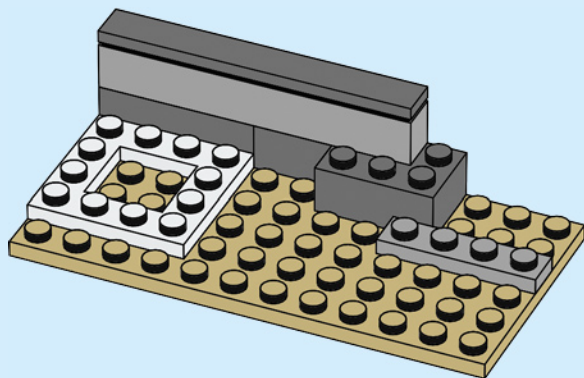



1x

8

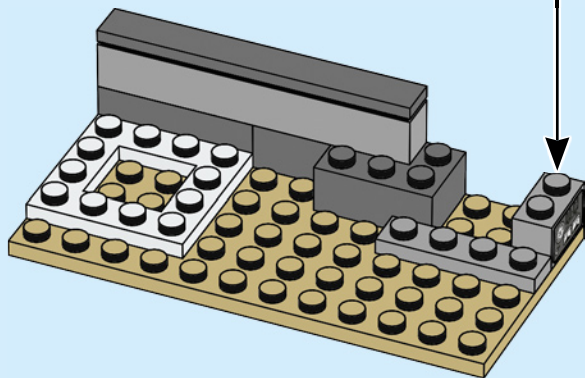
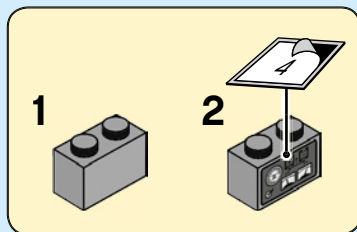



2x



1x

9

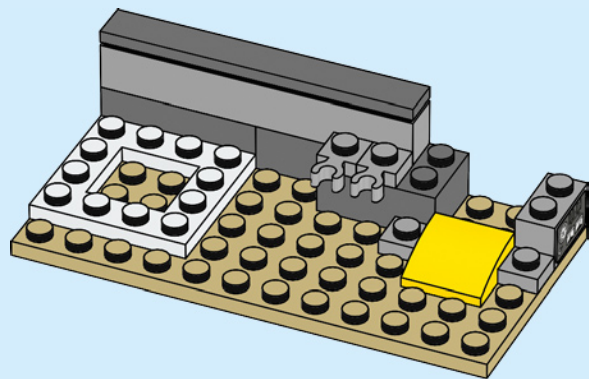

2x



1x

10

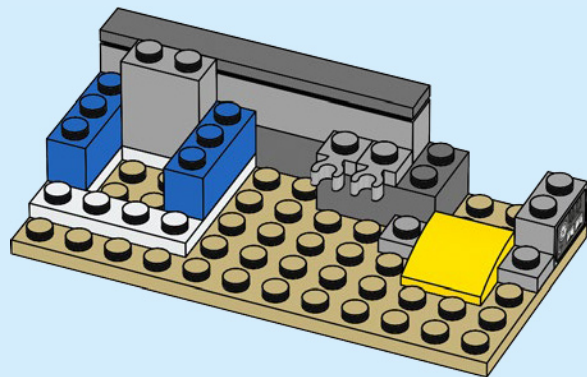



1x



1x

# 11

1



2

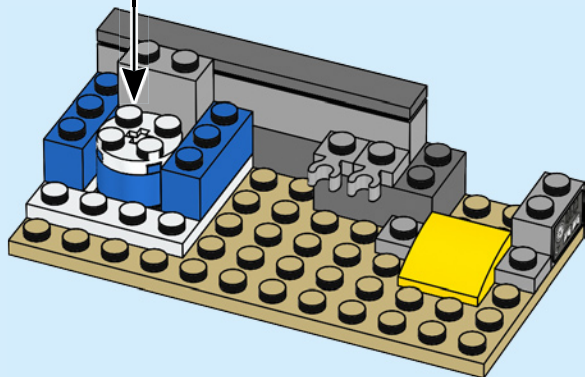



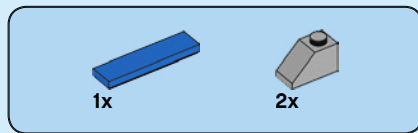

12

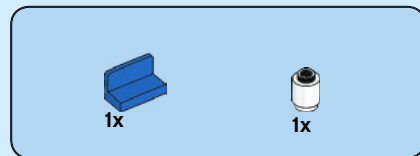
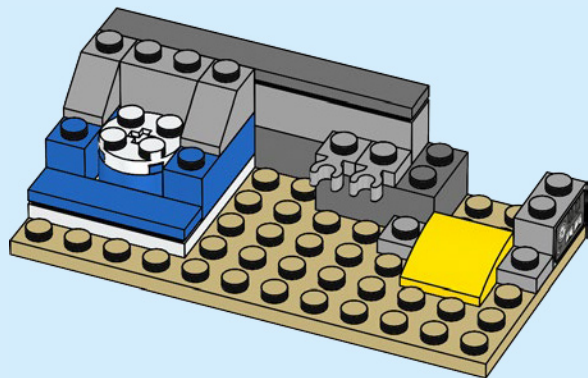

13

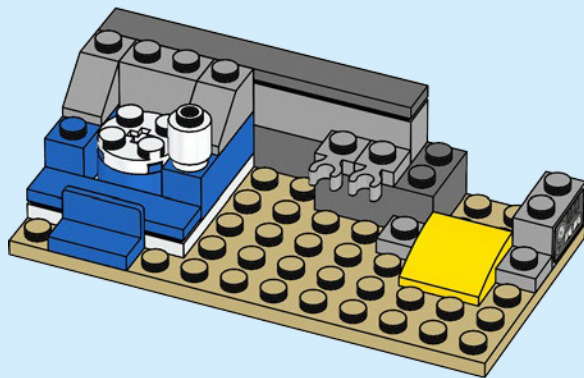

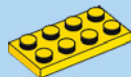
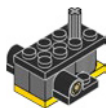

1x

14

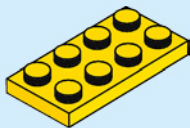

1x

15

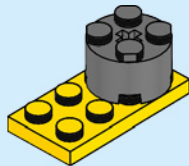



2x

16

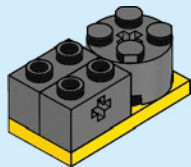

2x

17

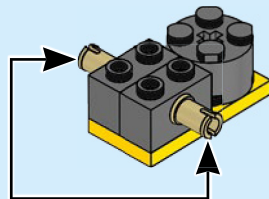

2x



18

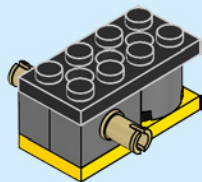

28

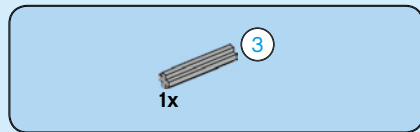

19

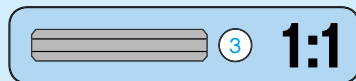
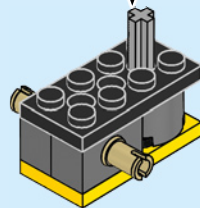
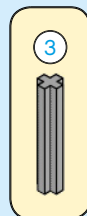



2x

20

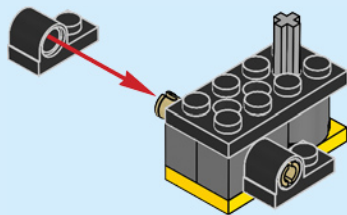

21

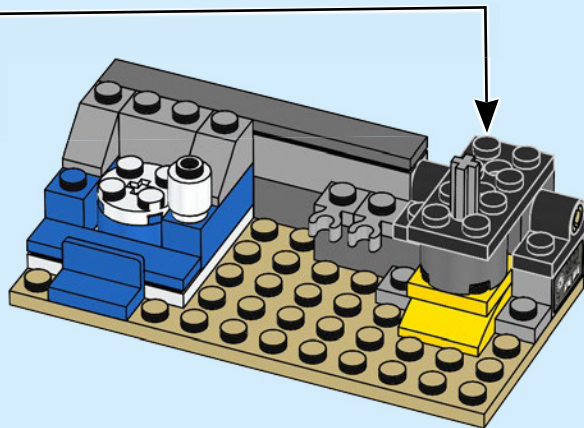



1x

22

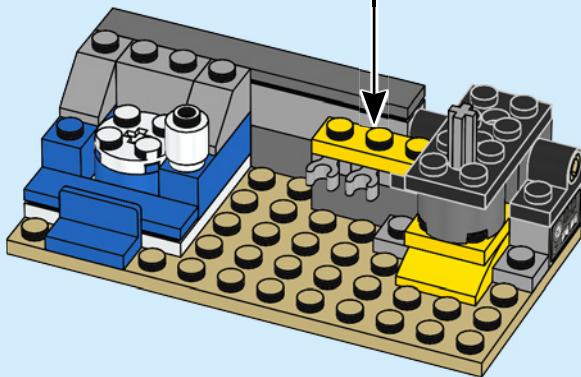
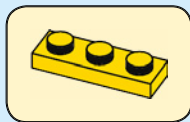



1x



1x



1x

# 23

1



2

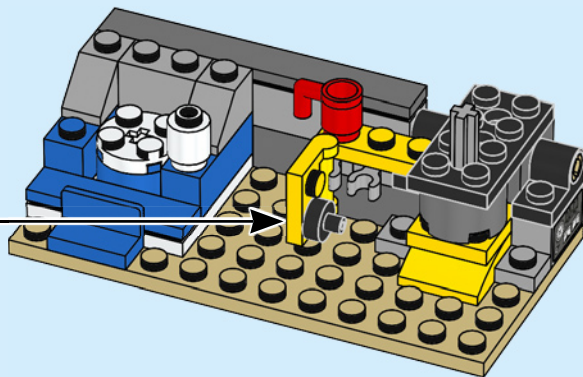

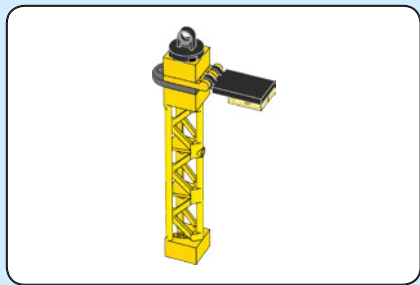

1x

24

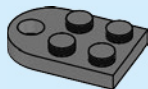





2x

25



1x

26

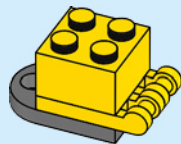



1x

27

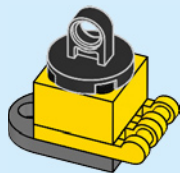

2x



1x

28

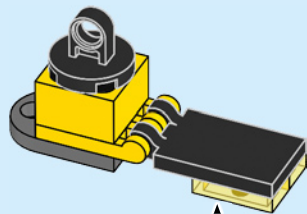

1



2

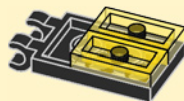

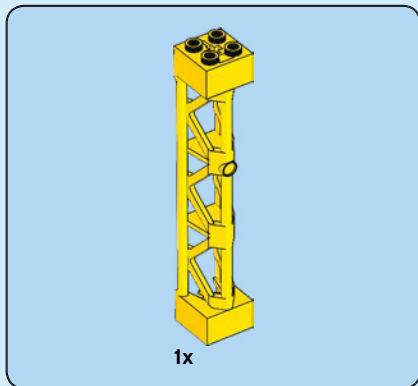

29

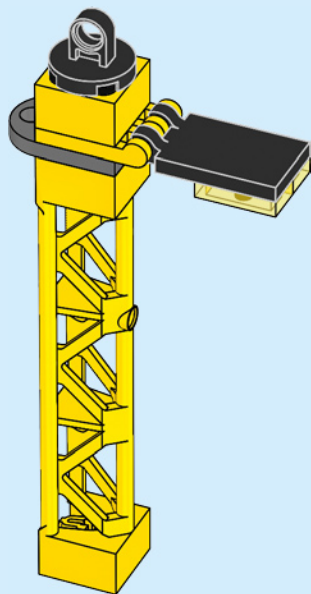

30

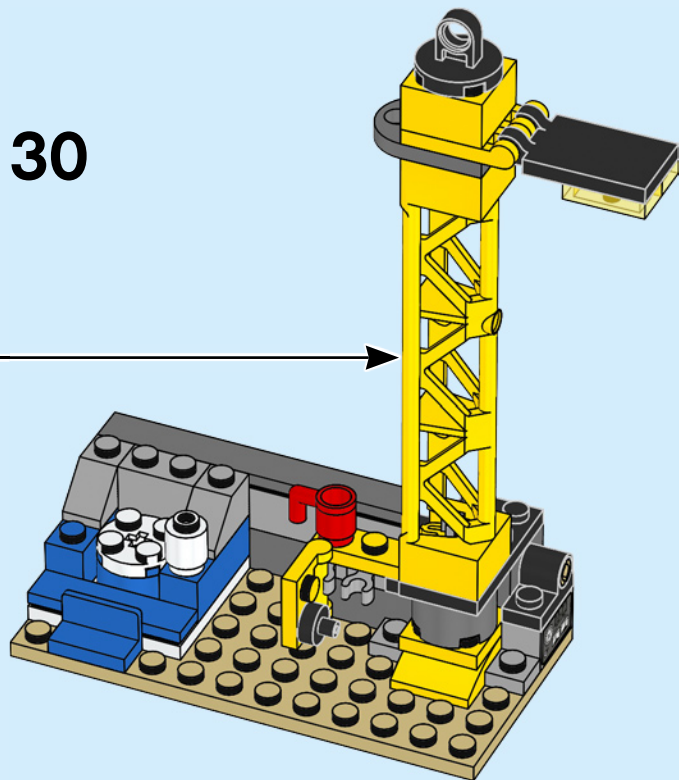

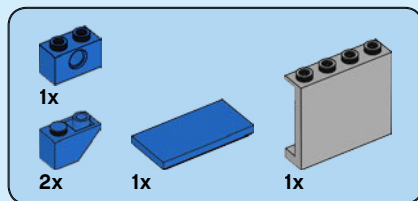

# 31

1

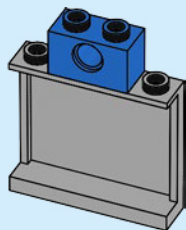

2

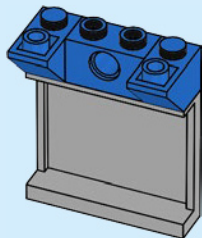

3

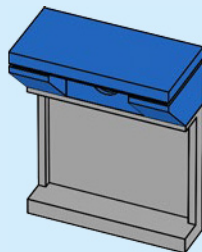

32

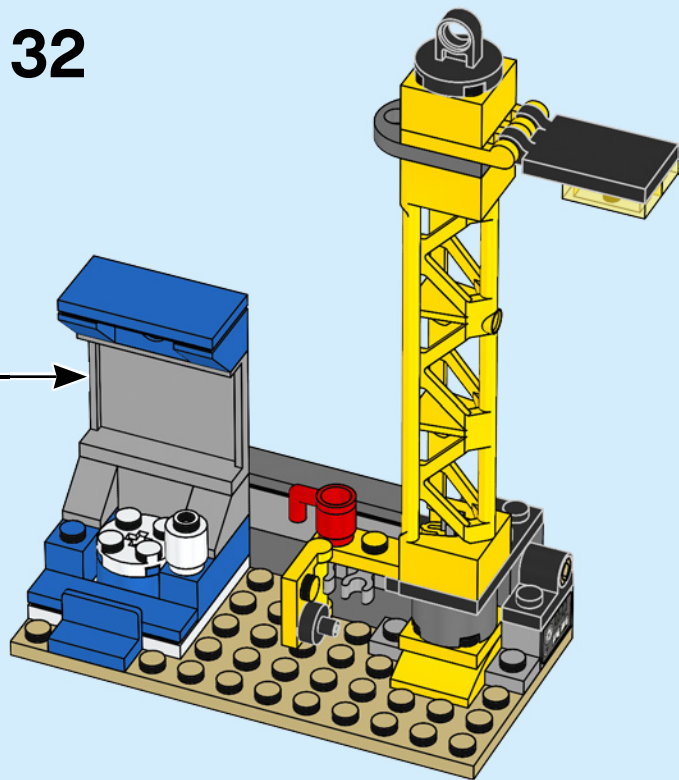

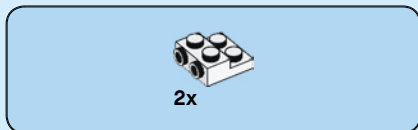
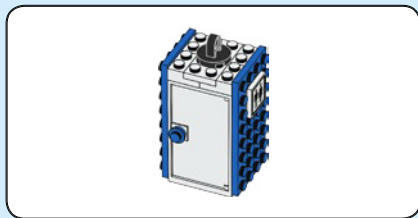

**33**

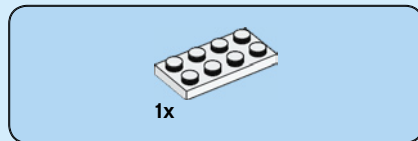
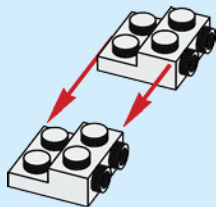

**34**

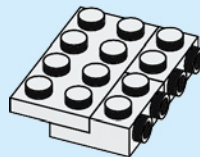



2x

35



2x

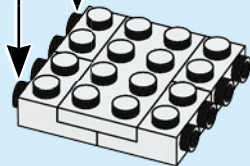



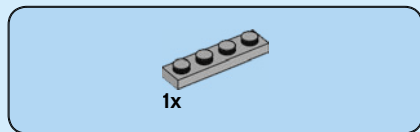

36

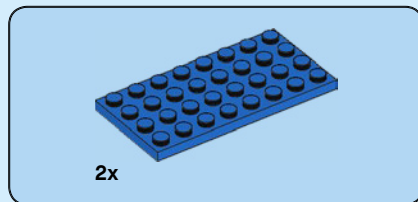
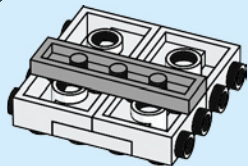
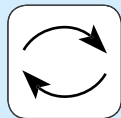

37

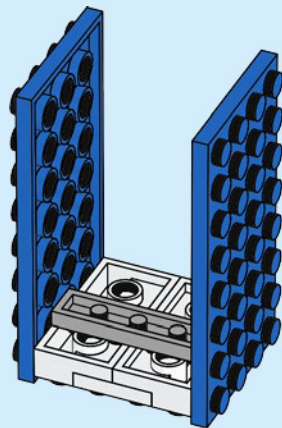

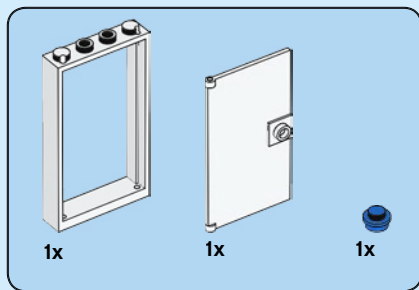

**38**

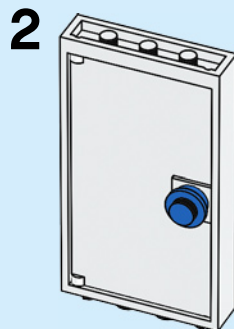
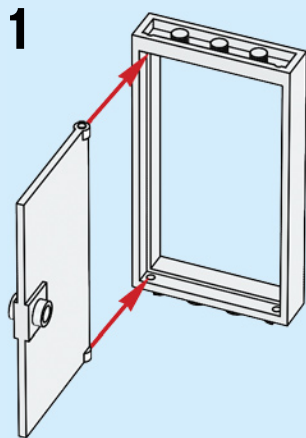

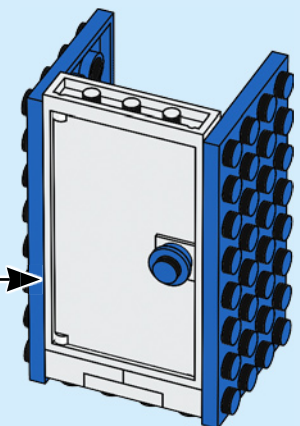

39

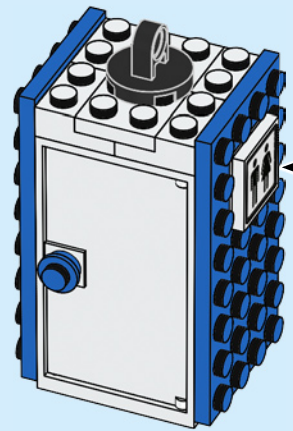
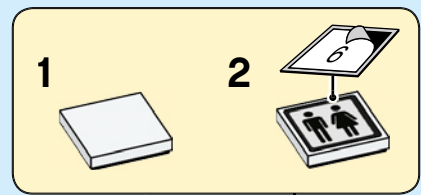
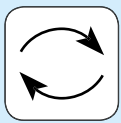

40

