

# Harry Potter HOGWARTS™

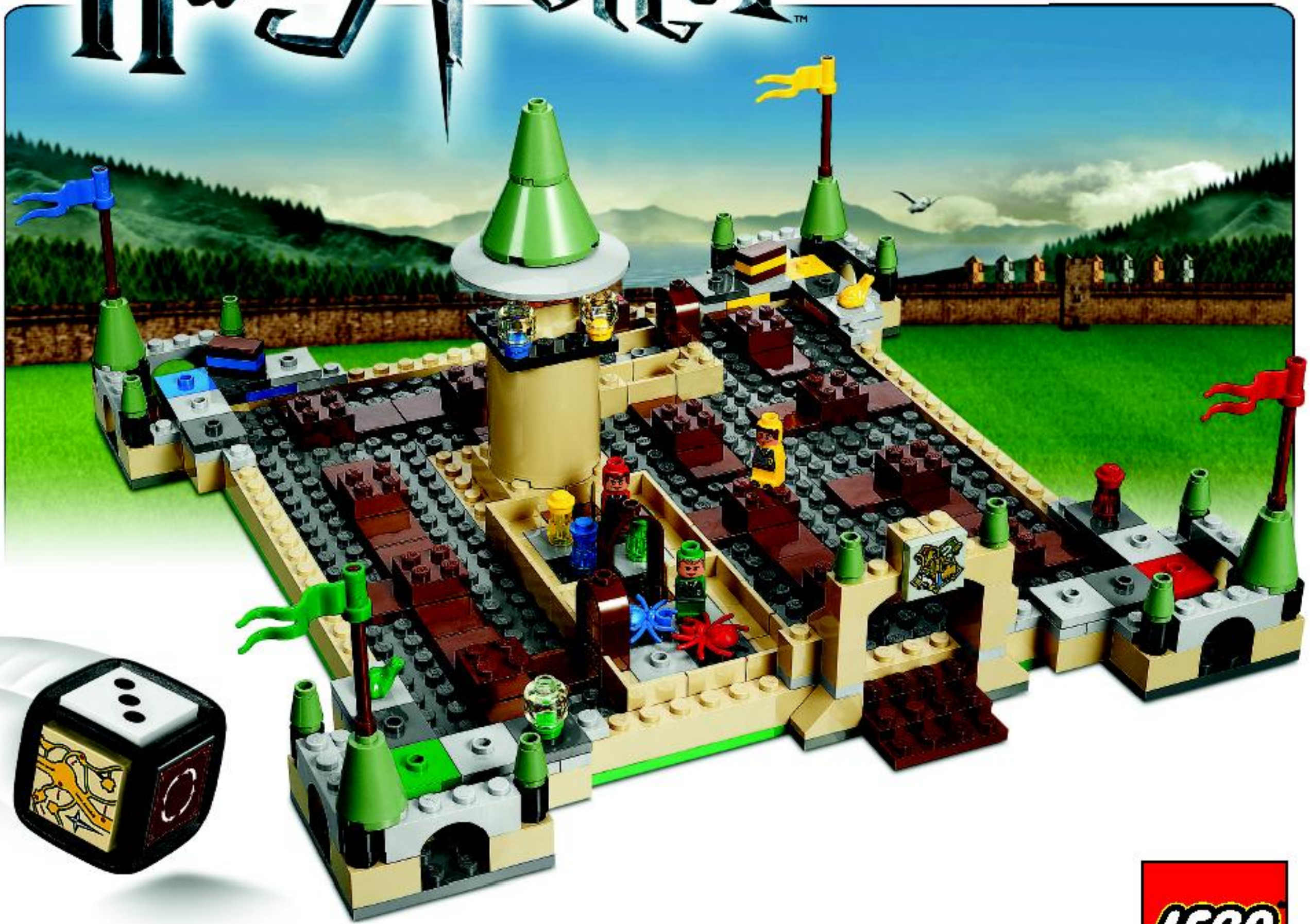

3862





**1**

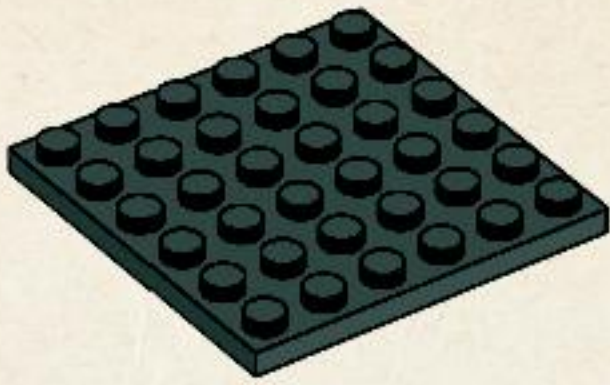

**2**

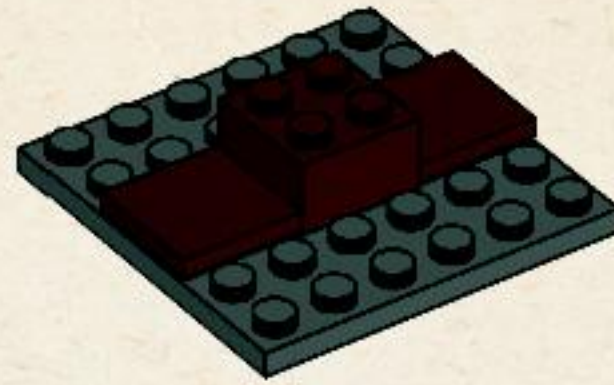

**4x**

---

**1**



**2**

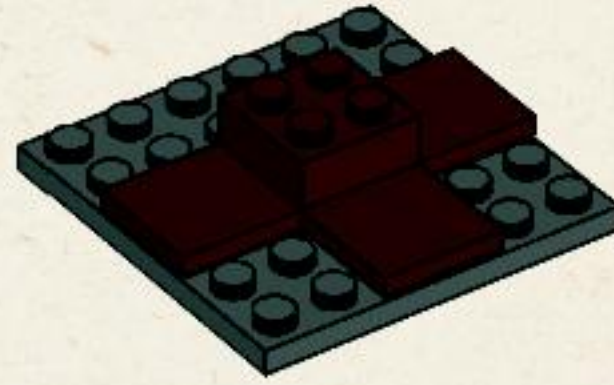

**4x**

---

**1**



**2**

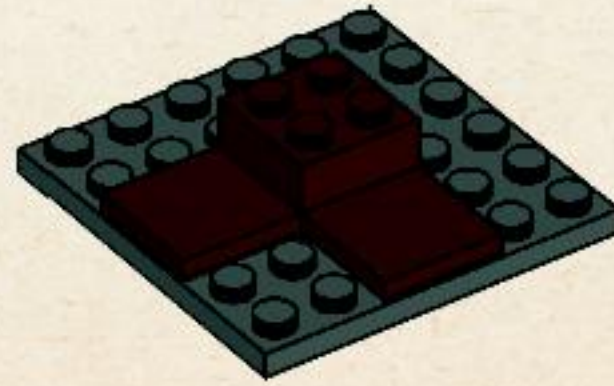

**4x**



1

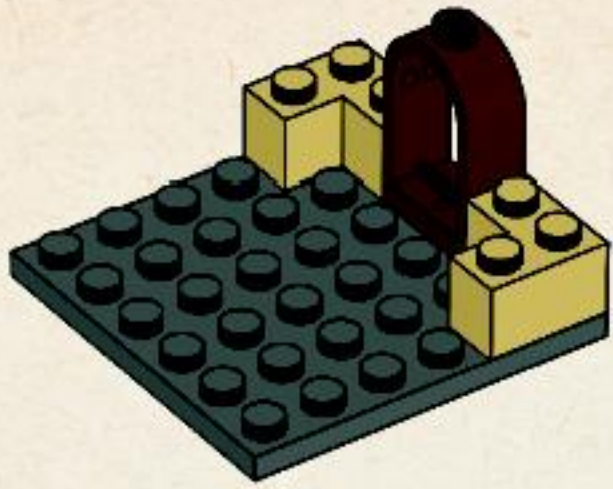

2

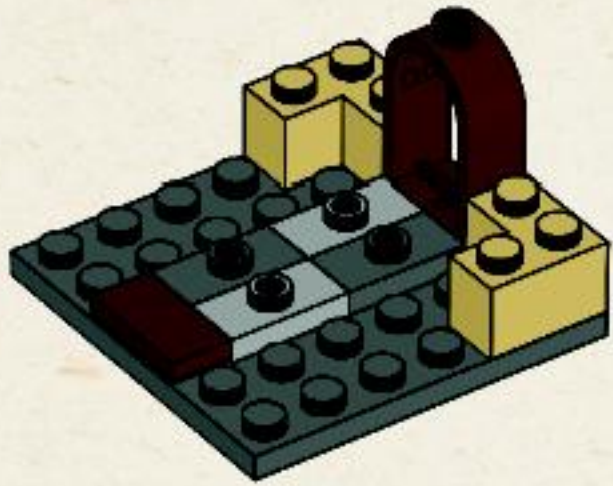

3

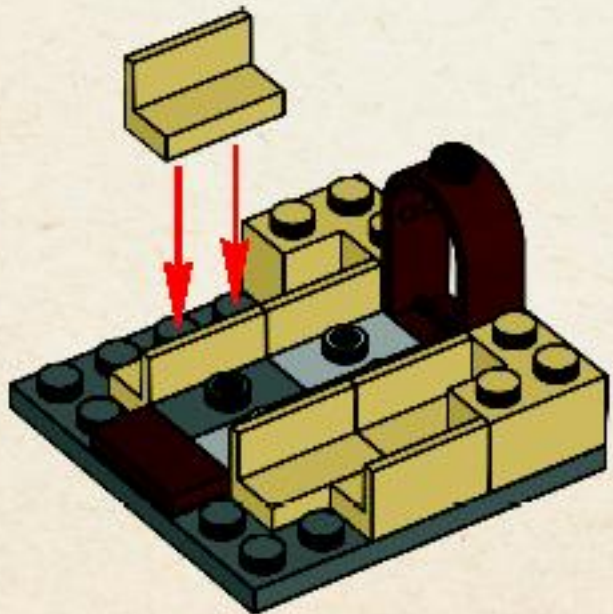

4

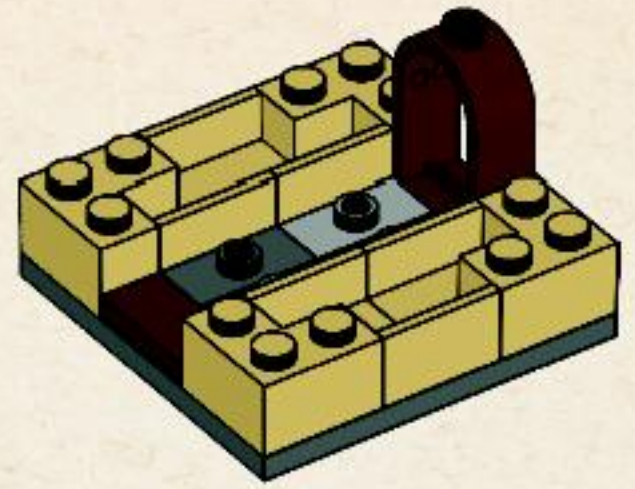

5

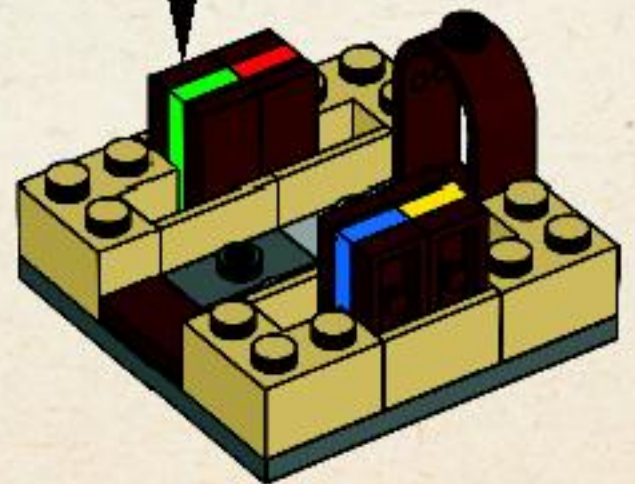
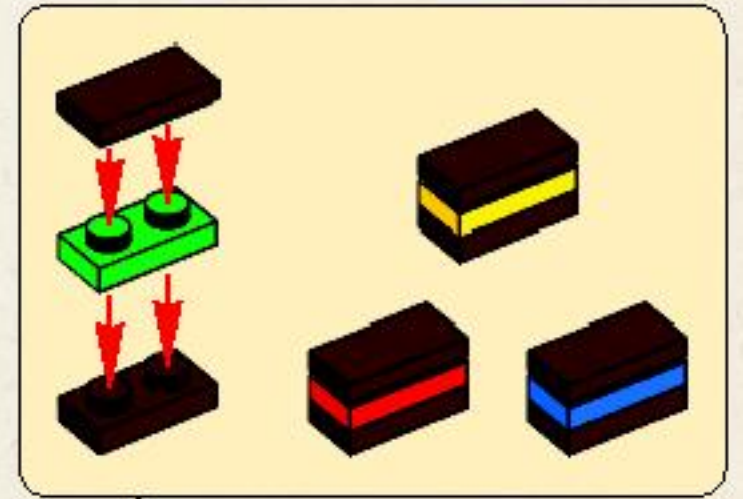



1

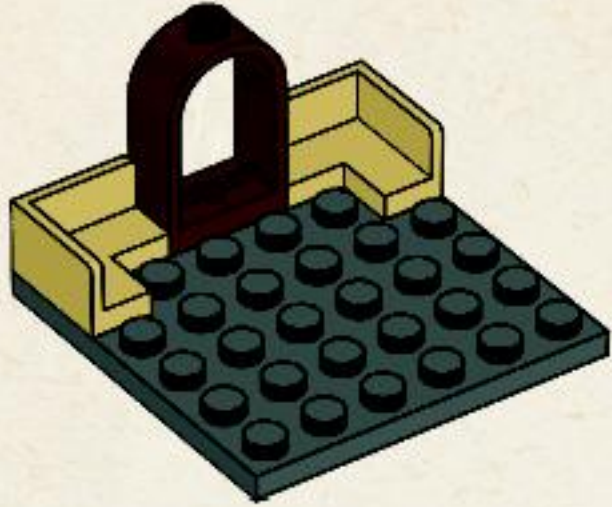

3

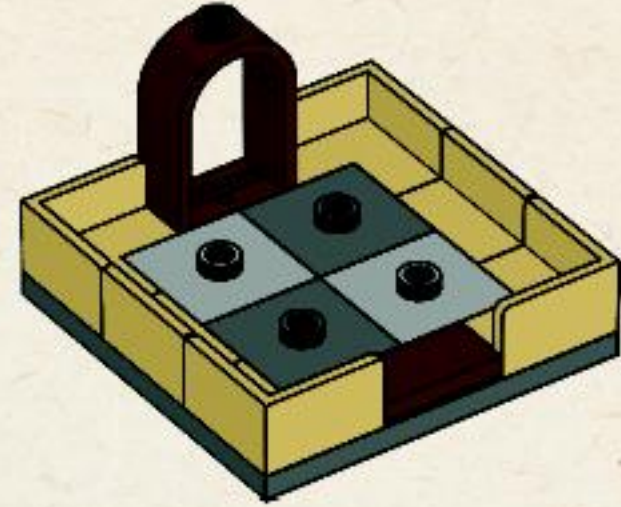

2

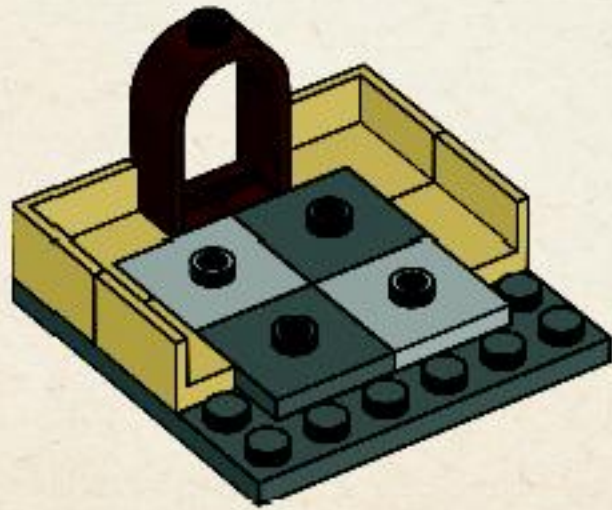

4

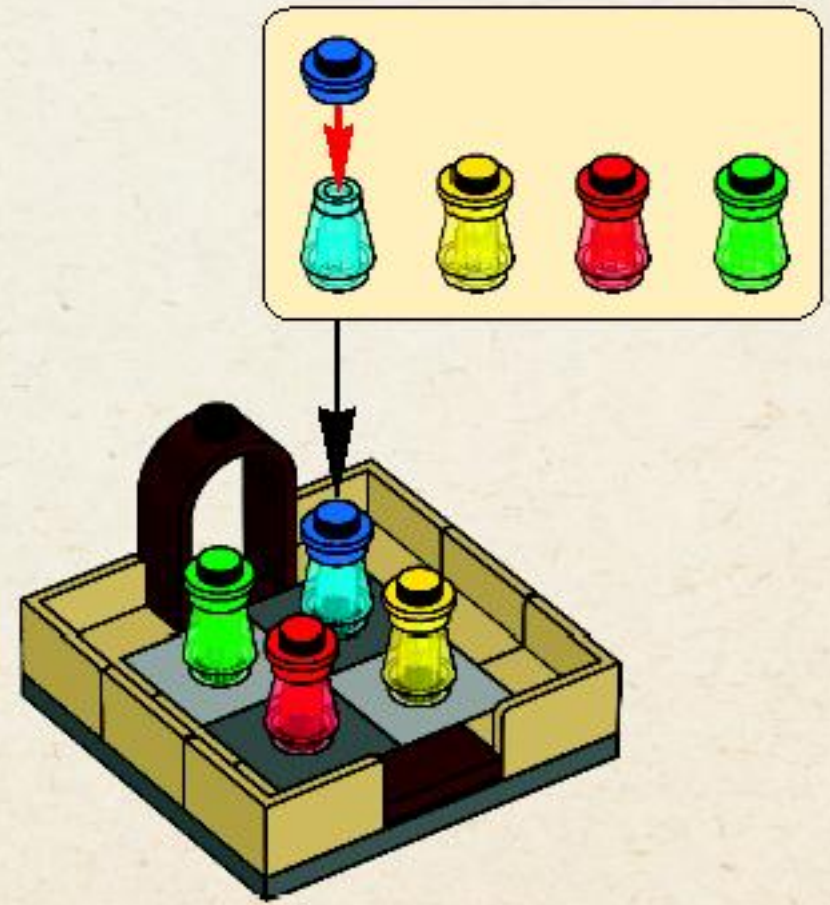



1

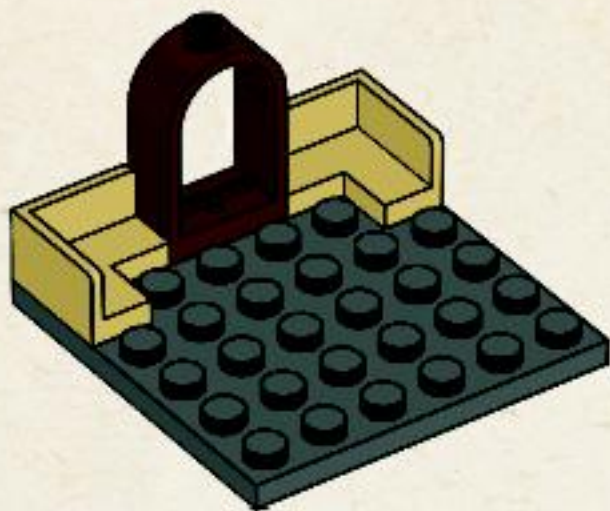

3

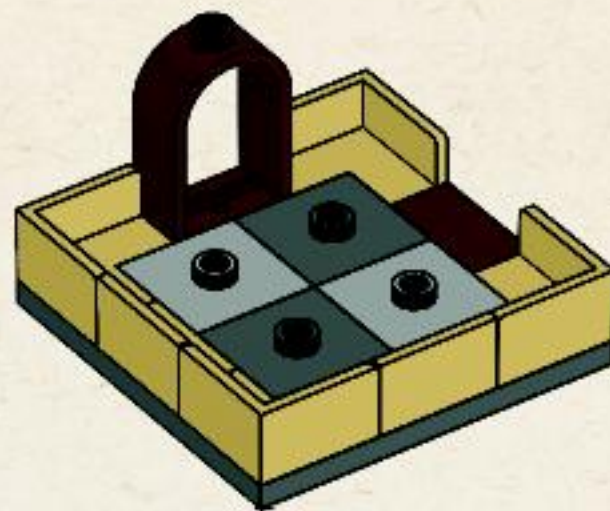

2

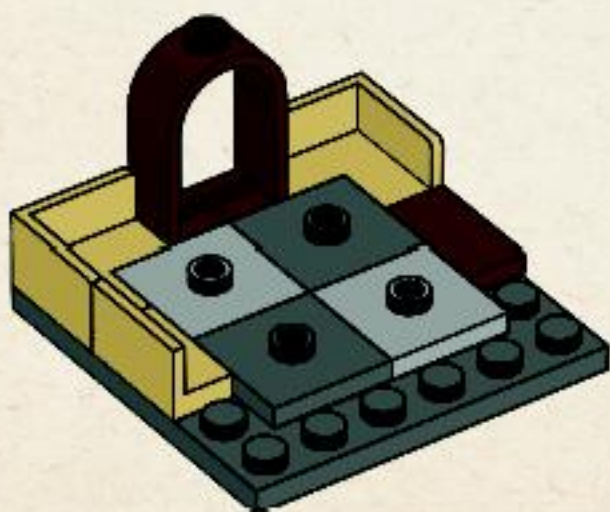

4

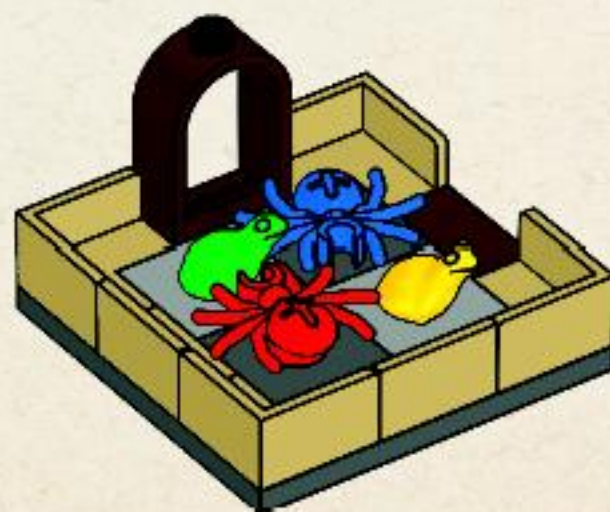











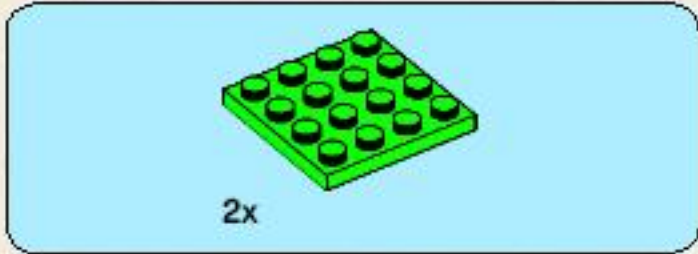
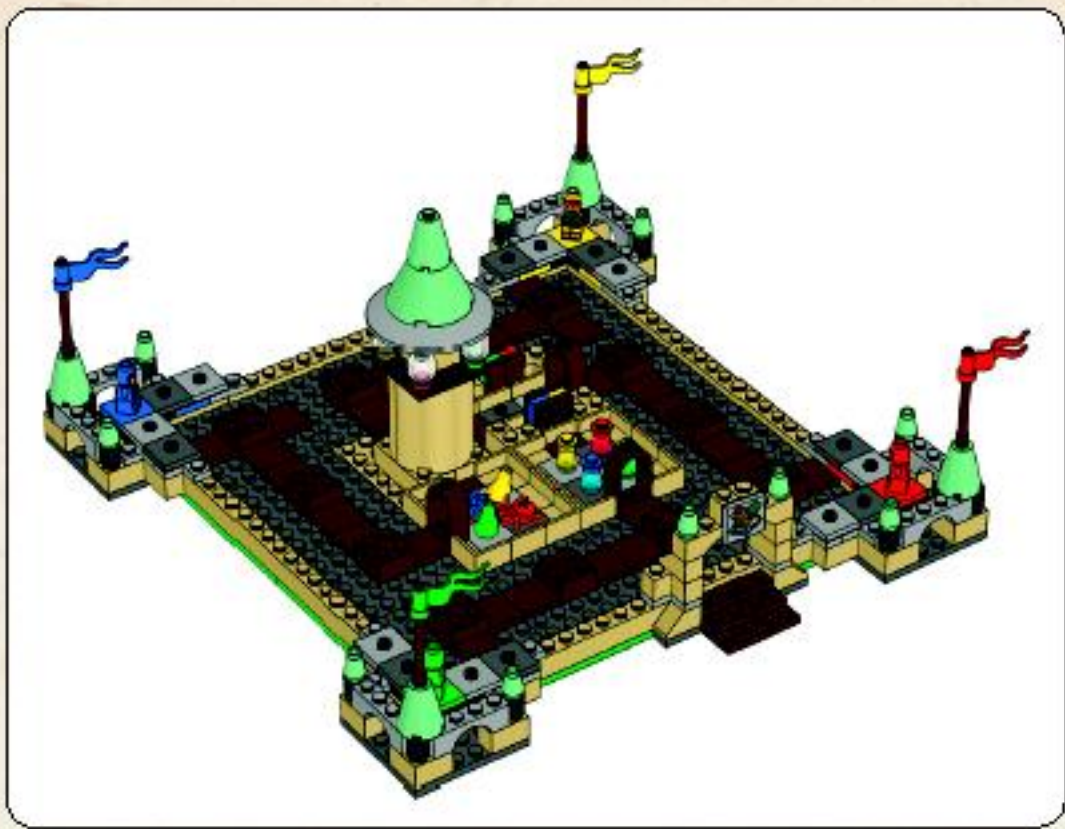

**1**

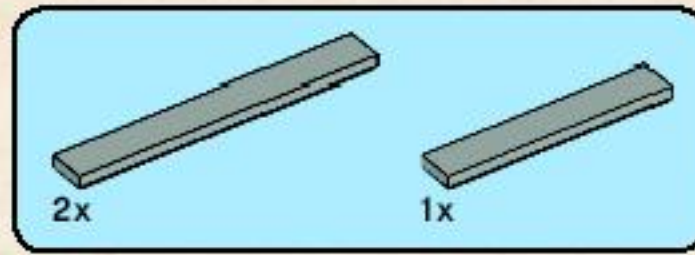
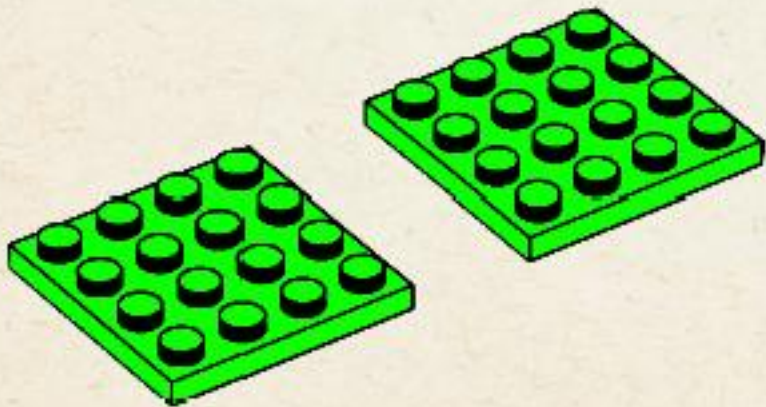

**2**

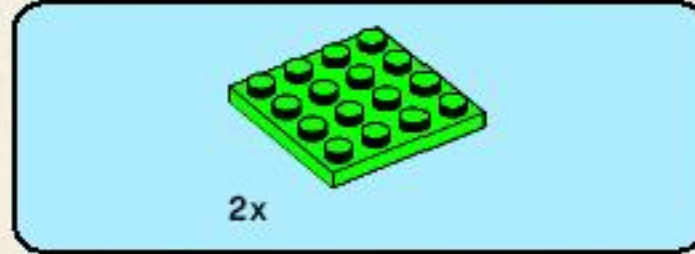
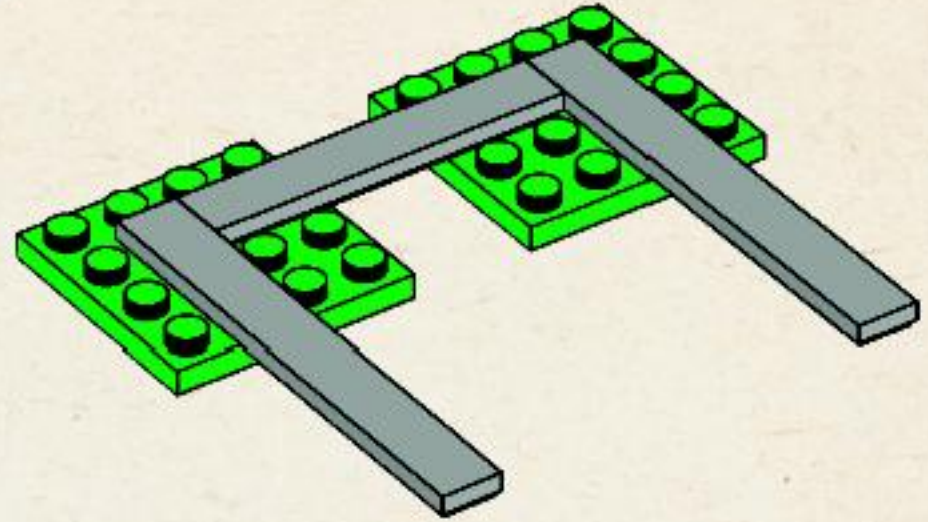

**3**

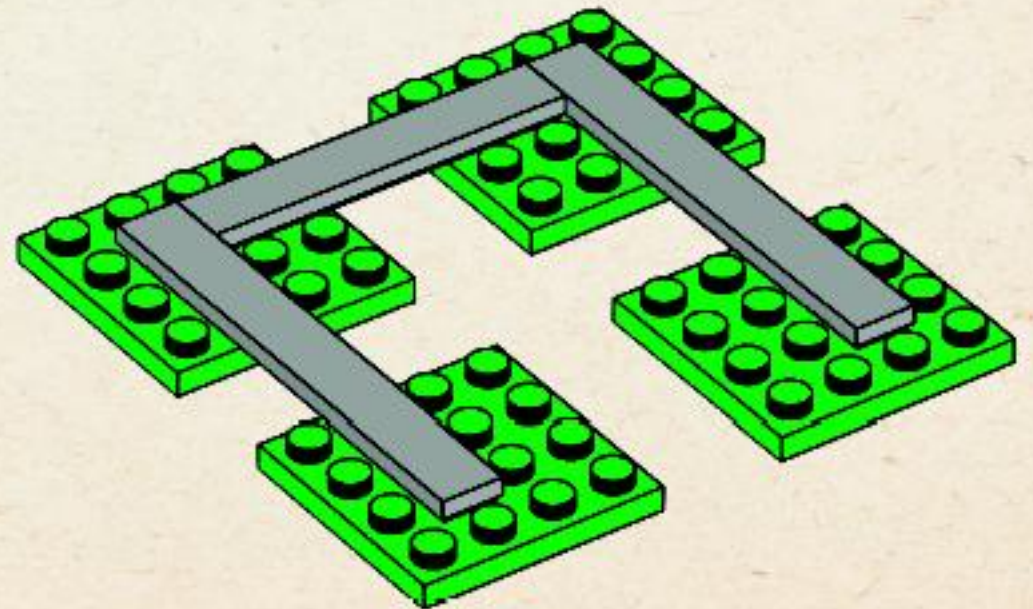



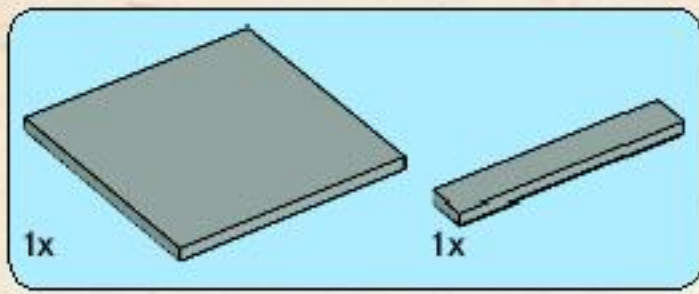

4

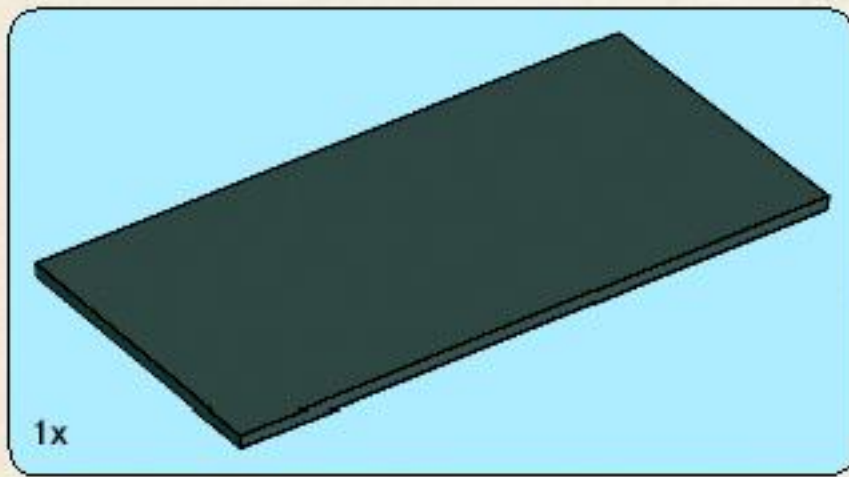
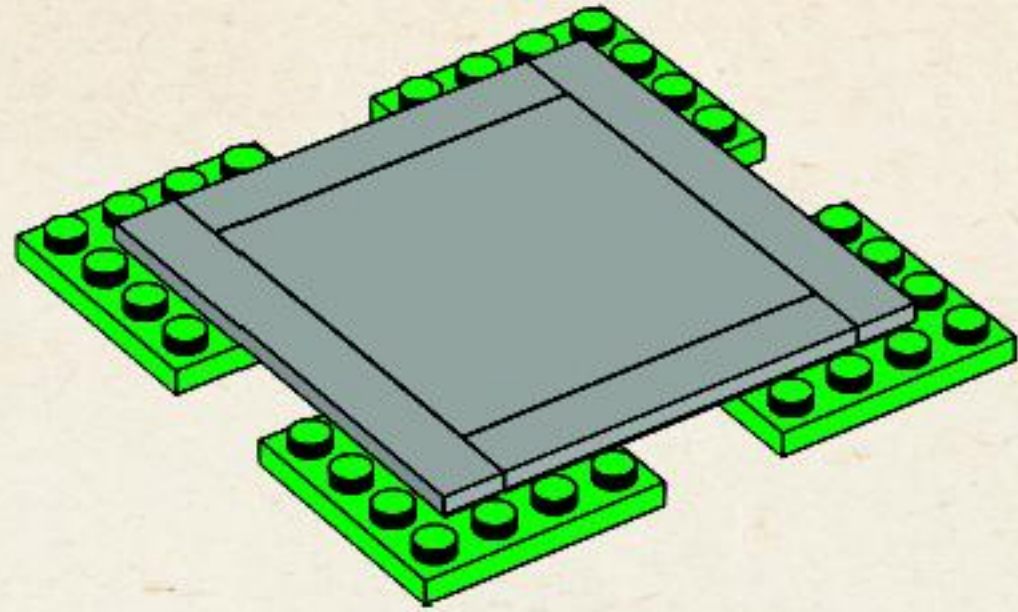

5

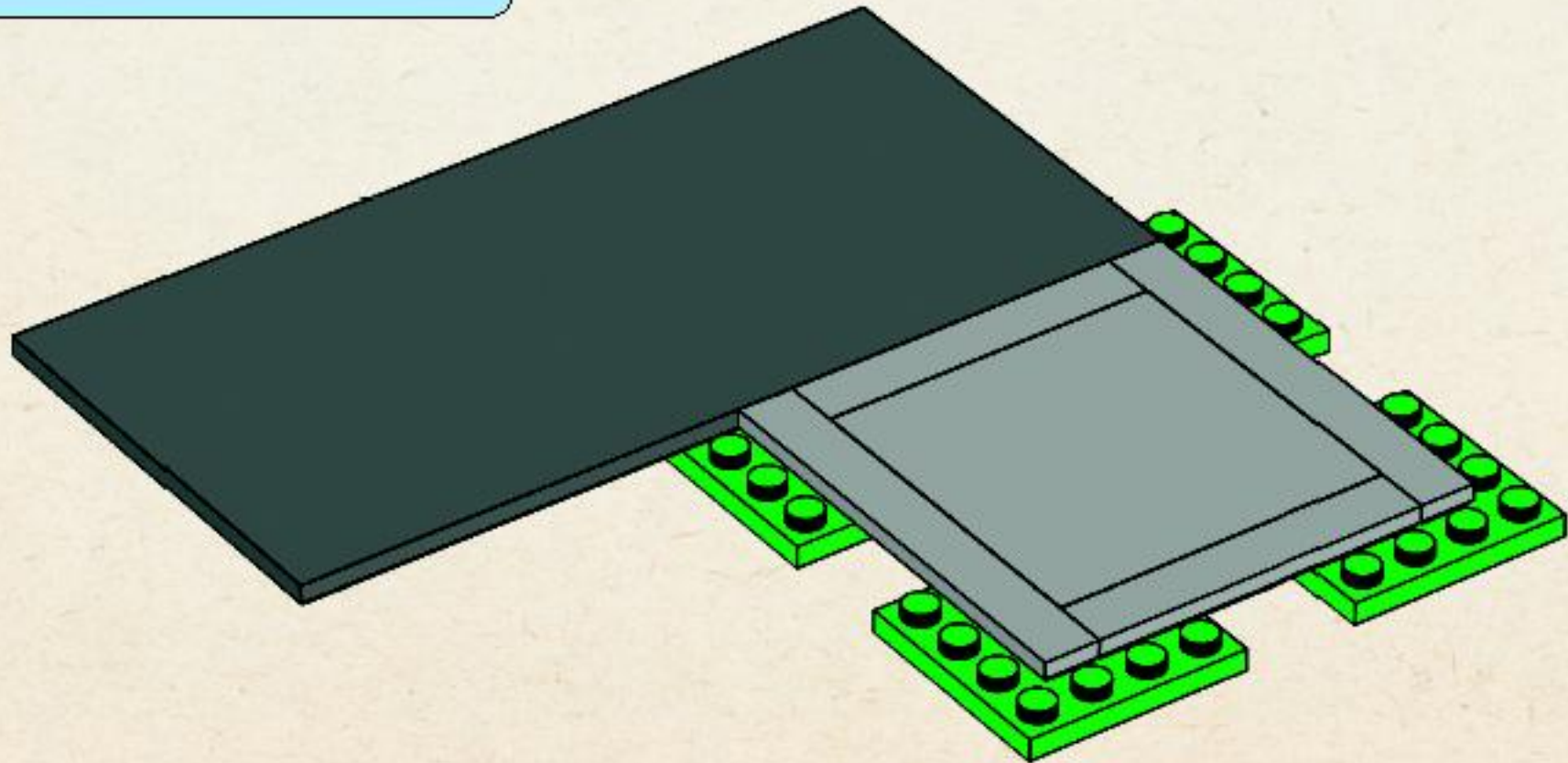



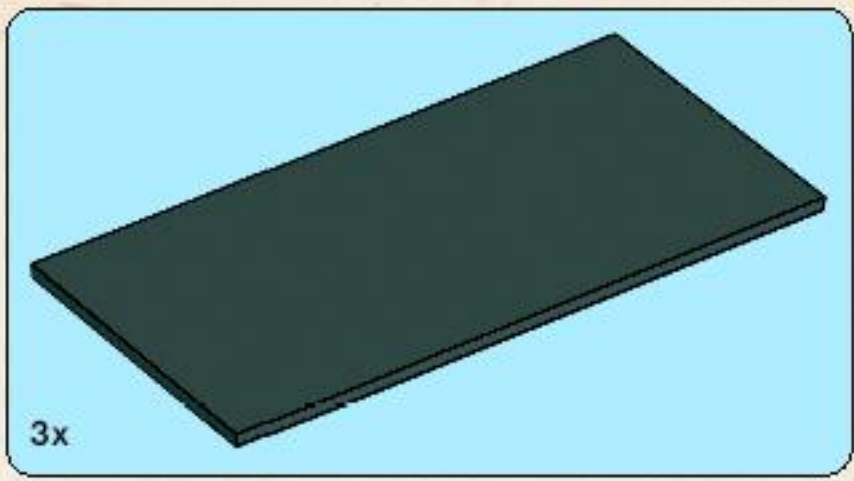

6

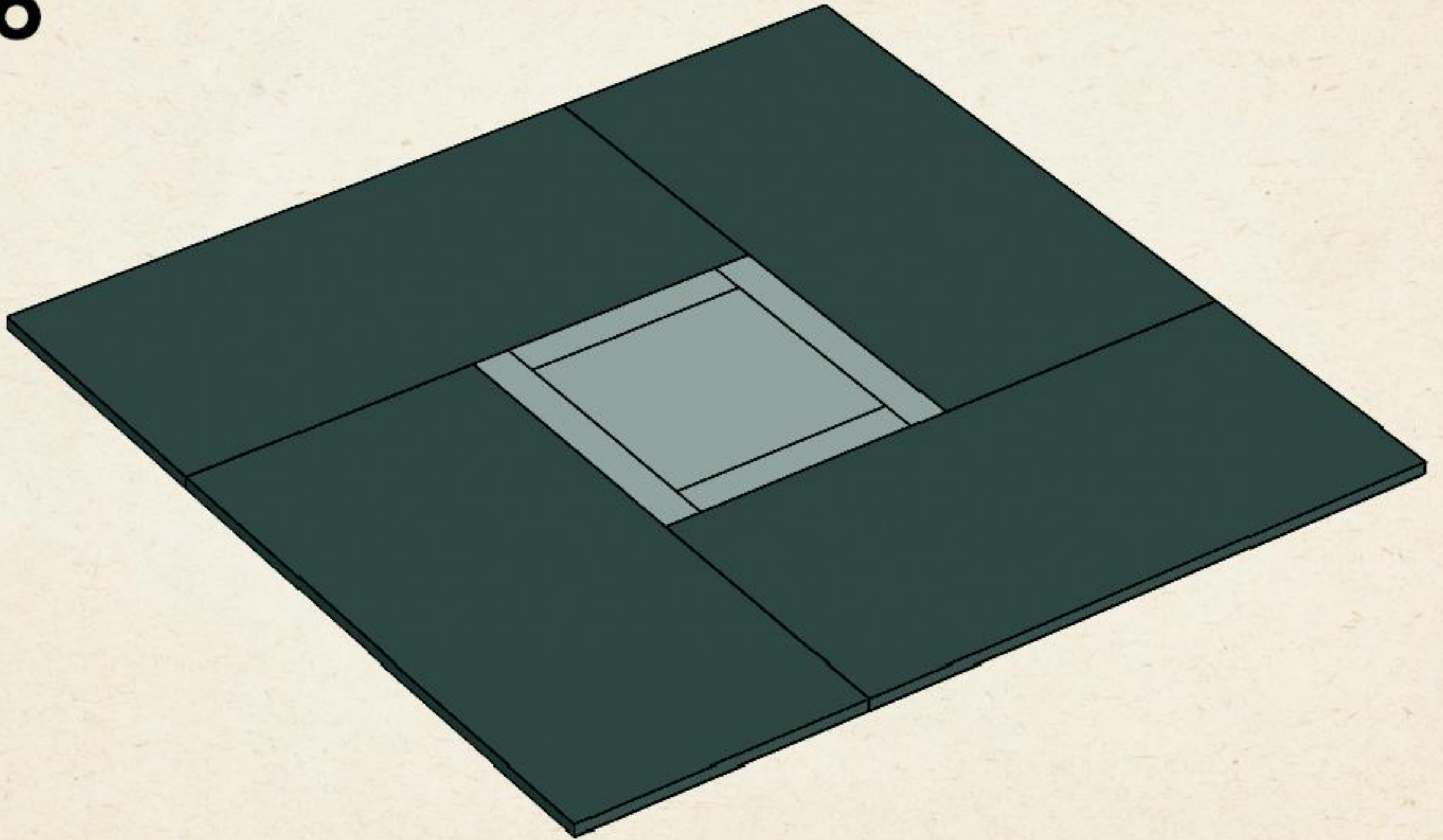



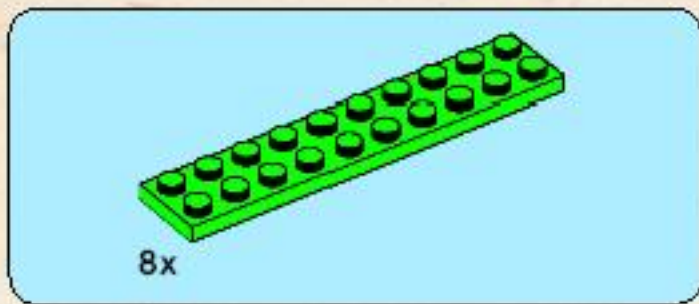

7

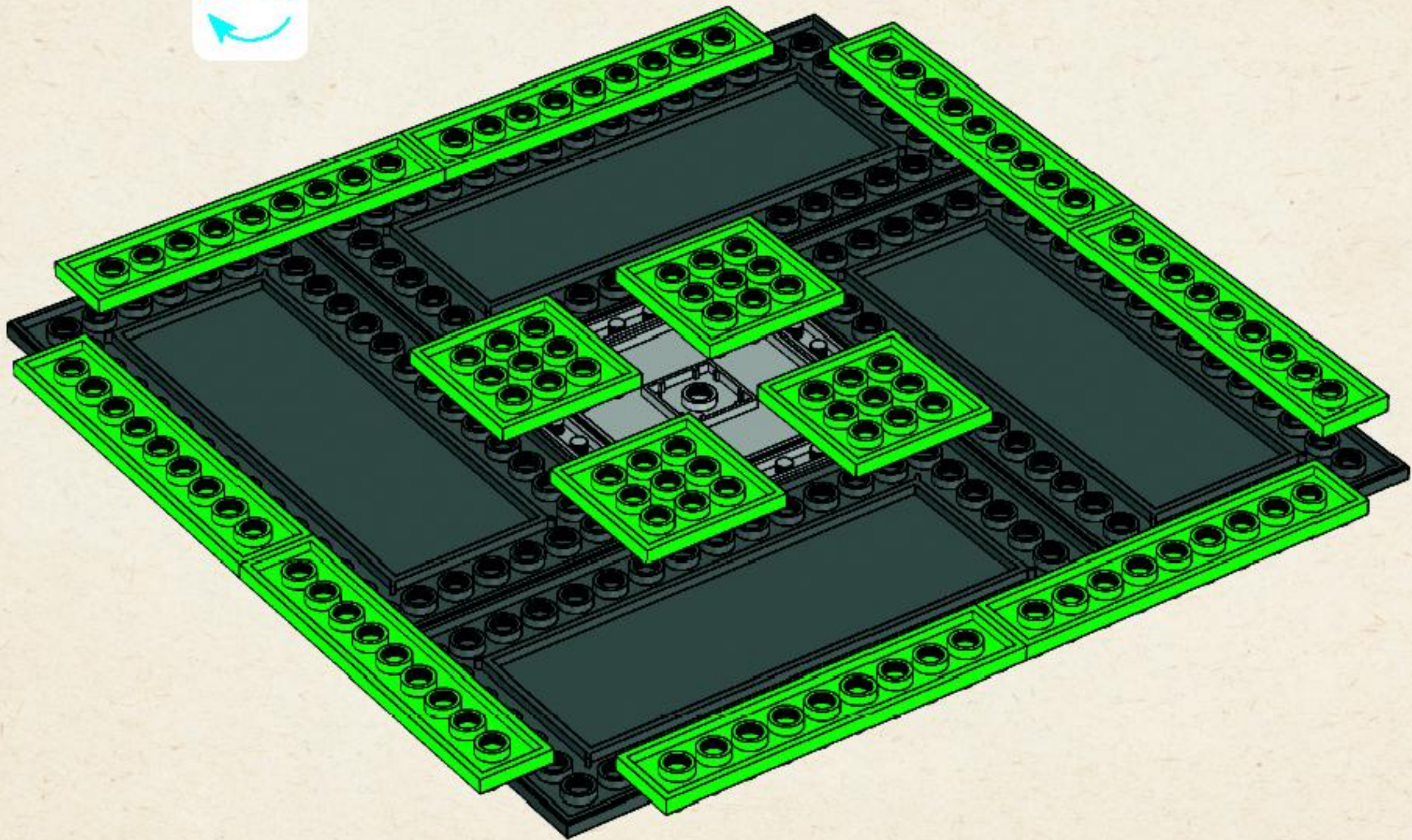



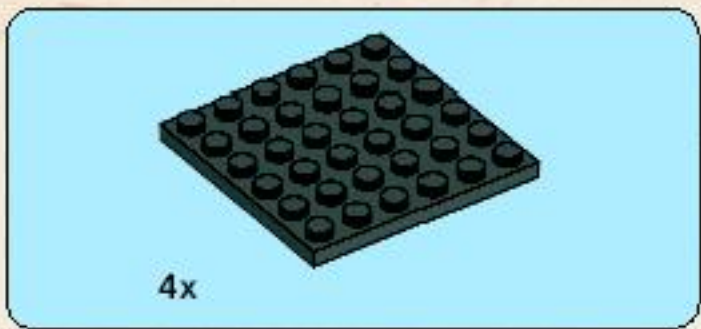

8

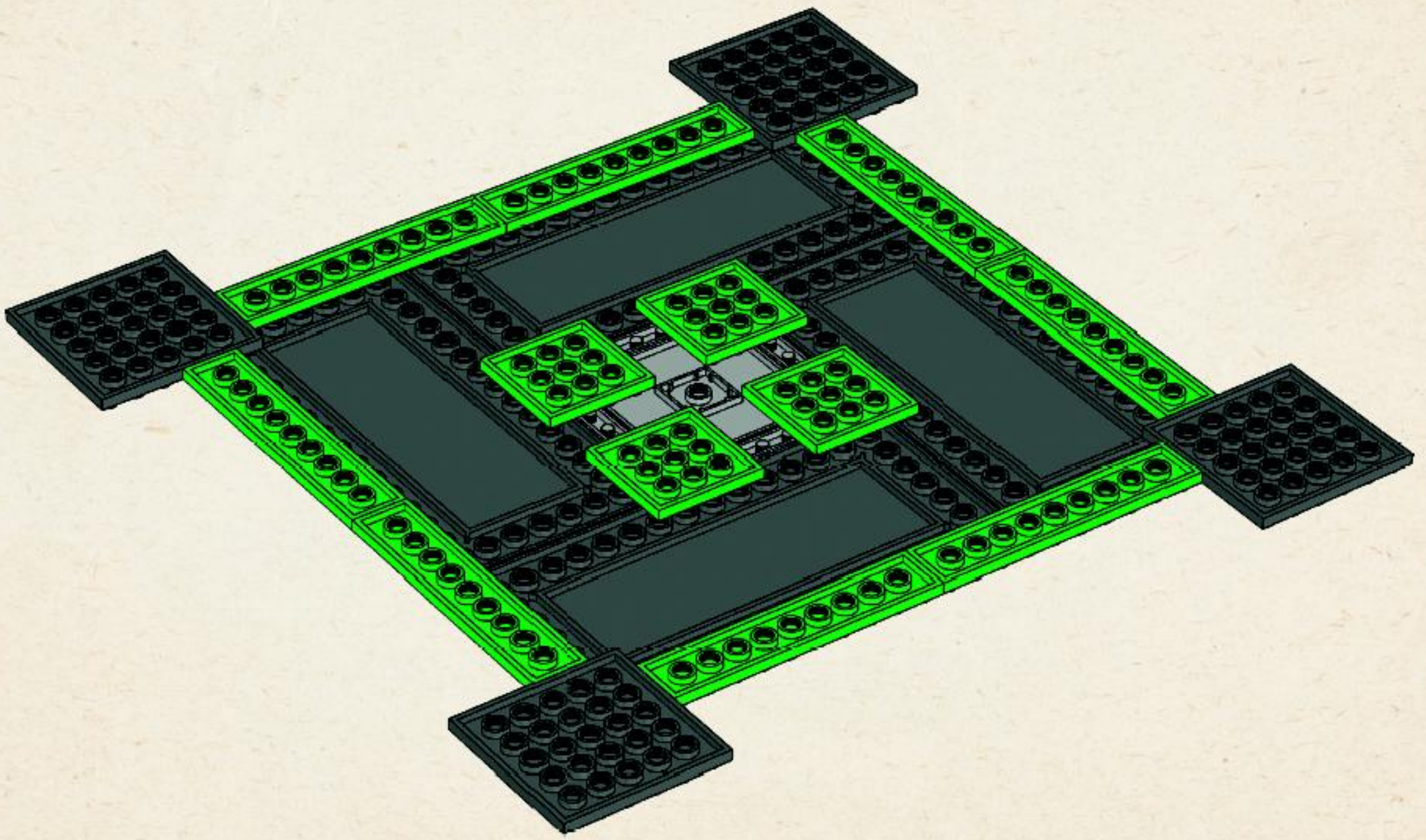



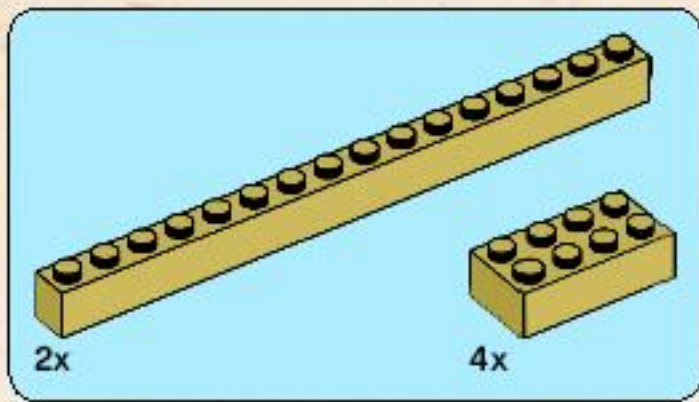

9

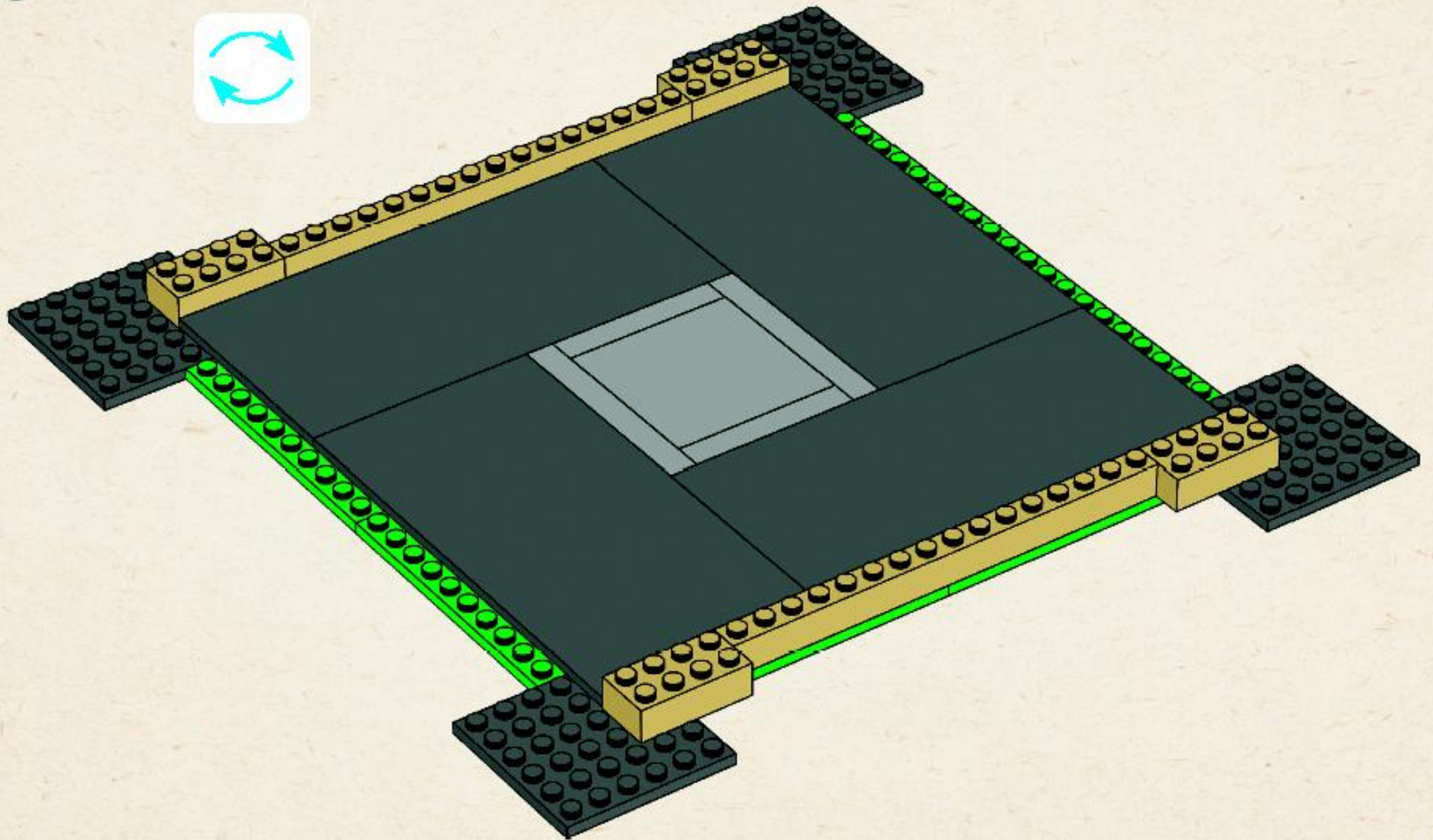



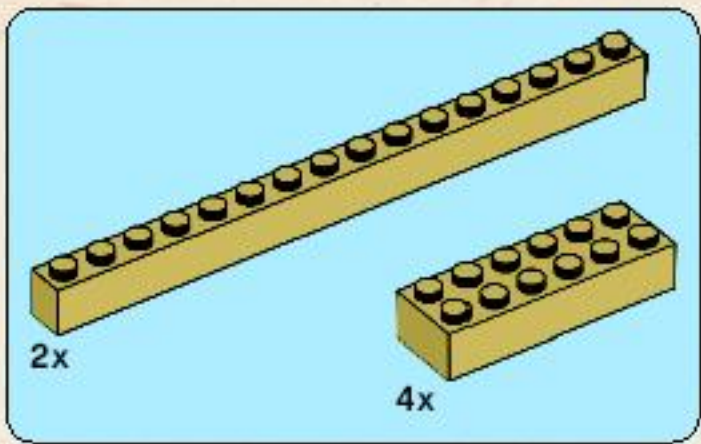

10

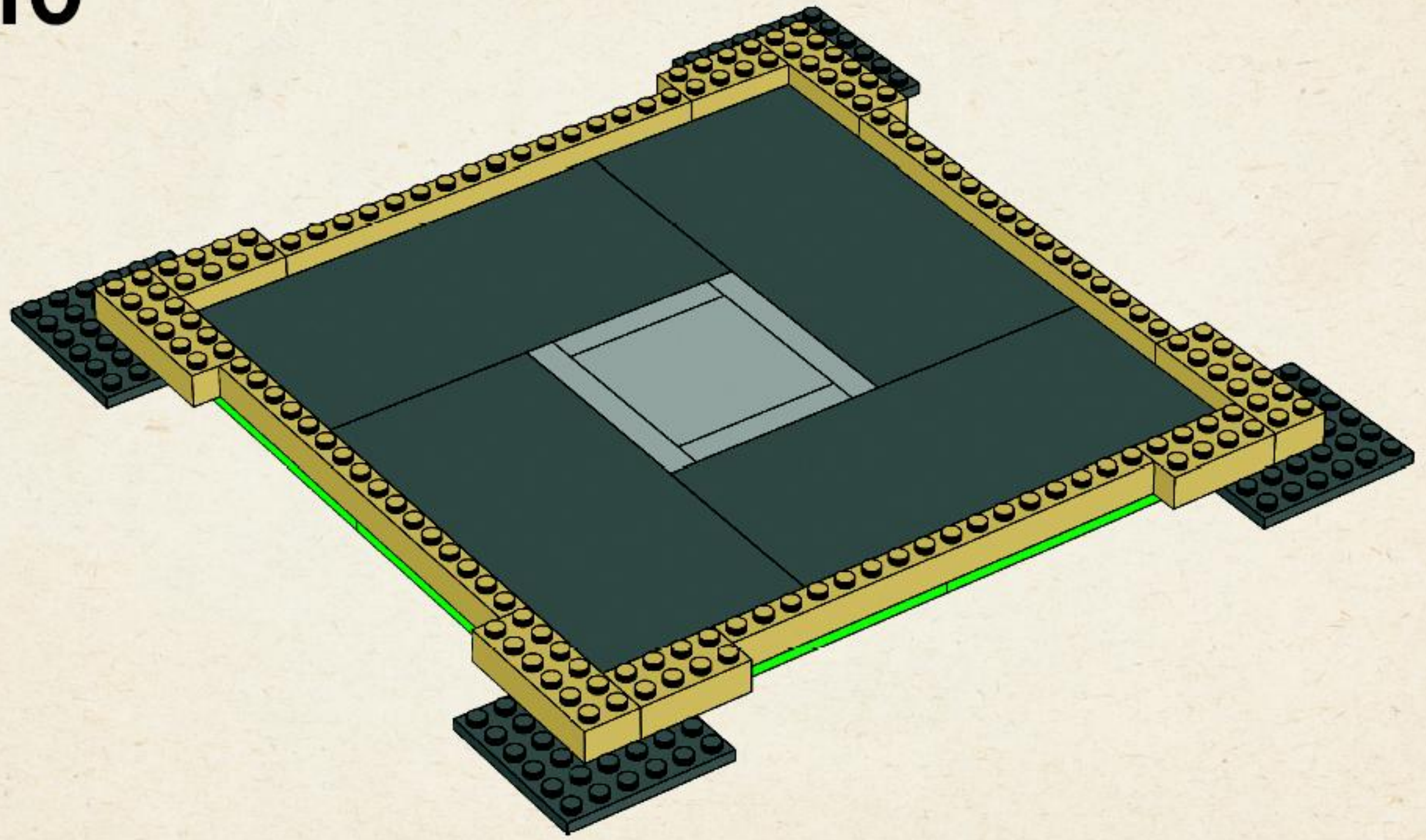





11

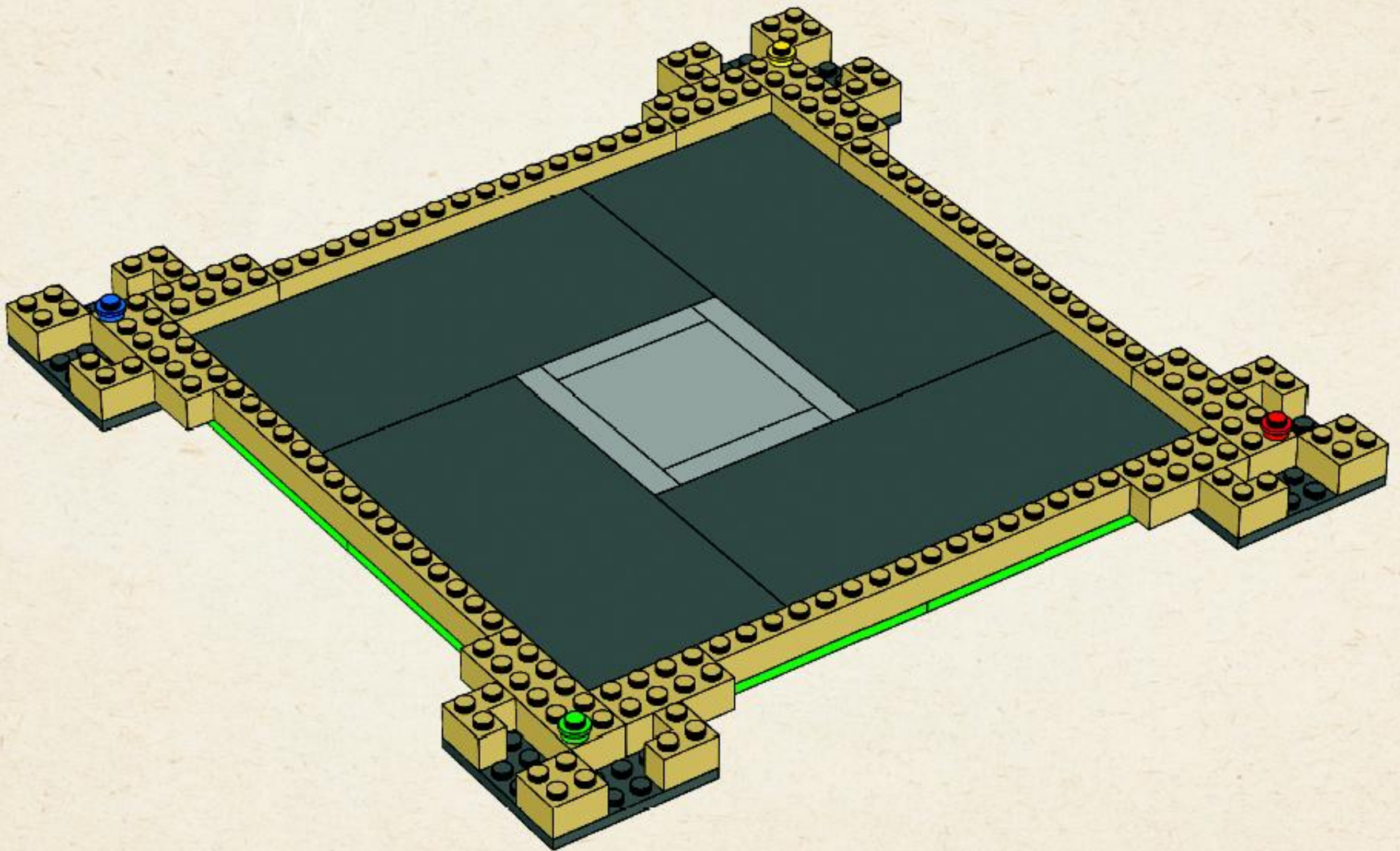



8x 2x 2x 2x 2x

12

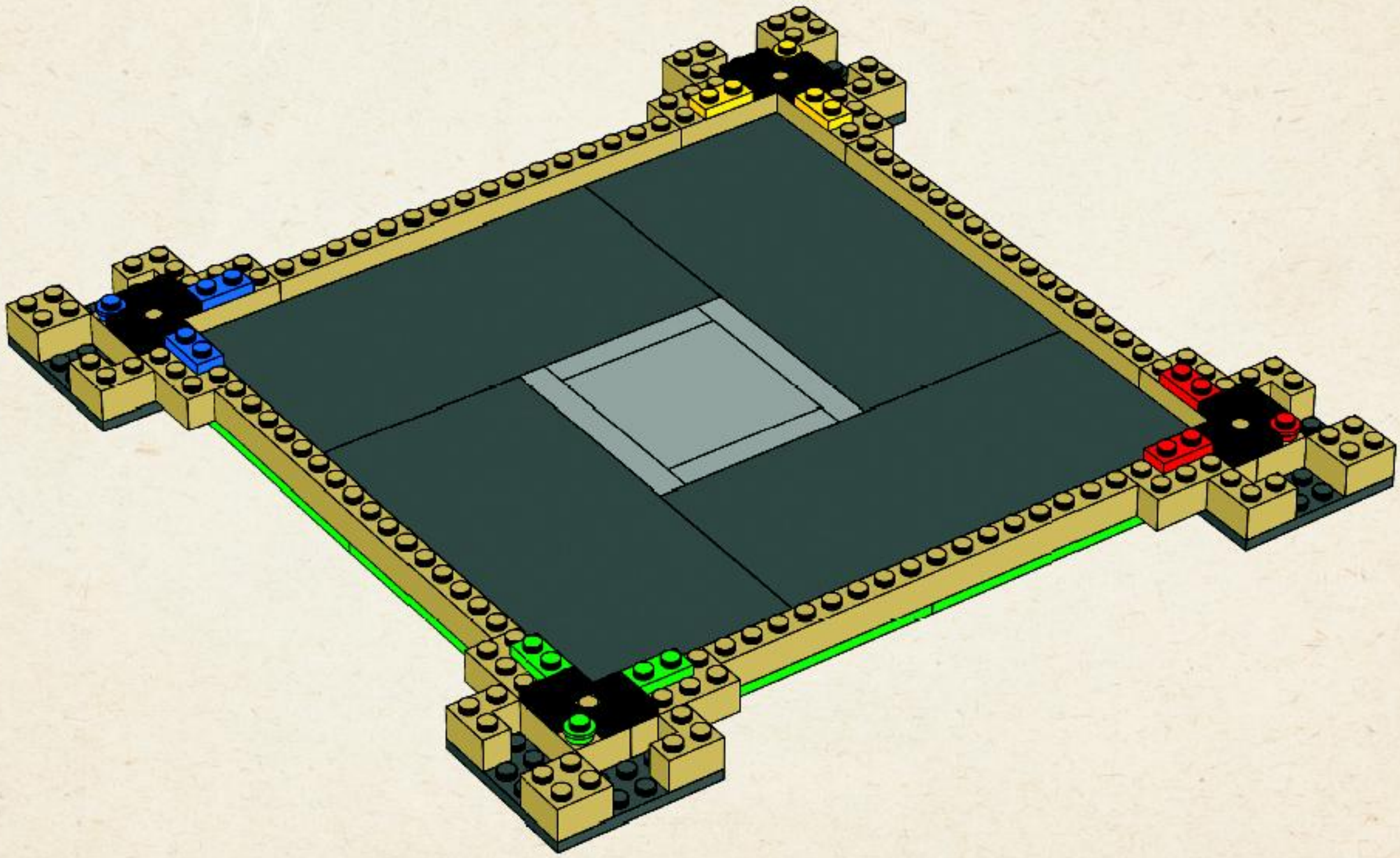







16x 8x

14

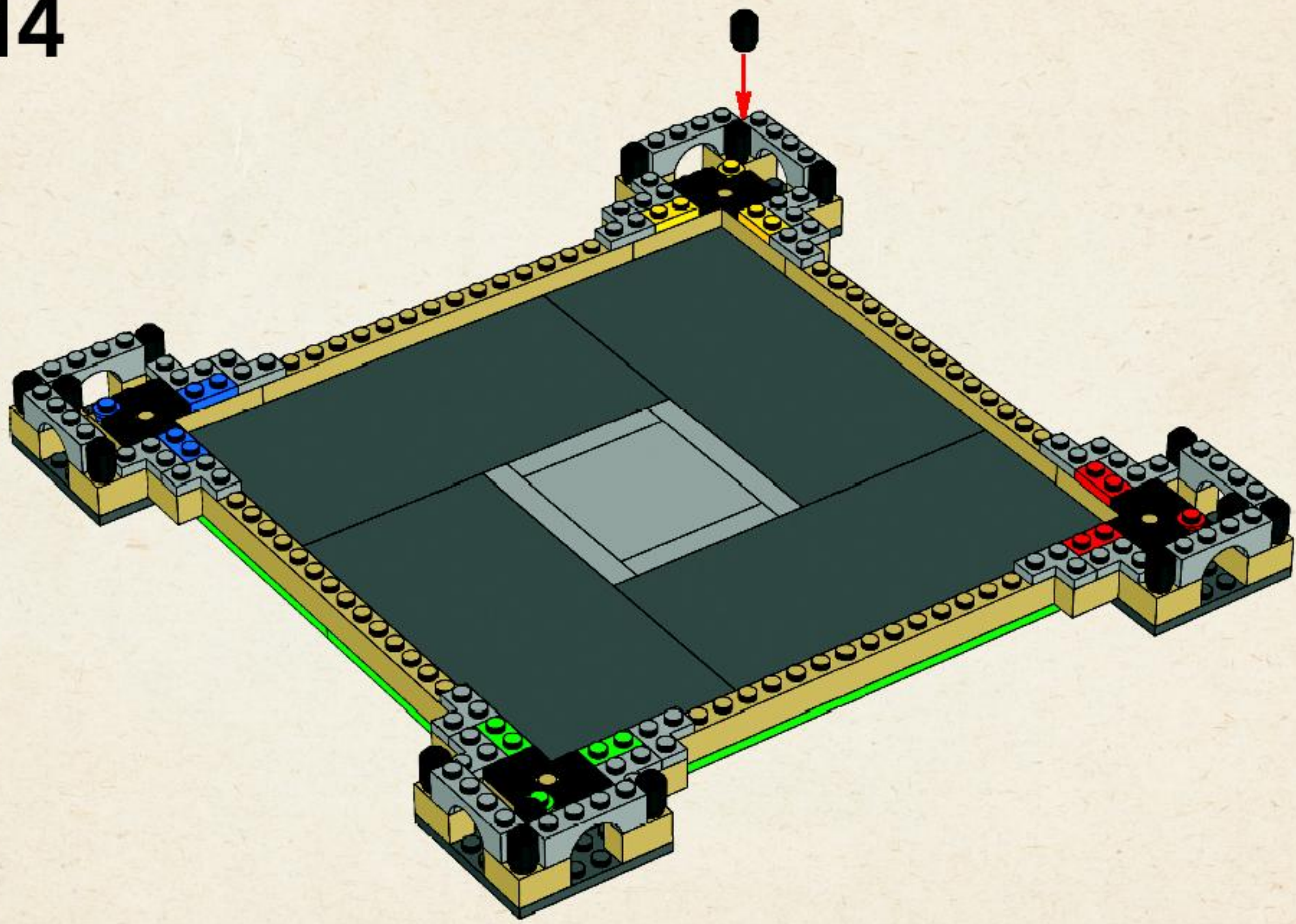



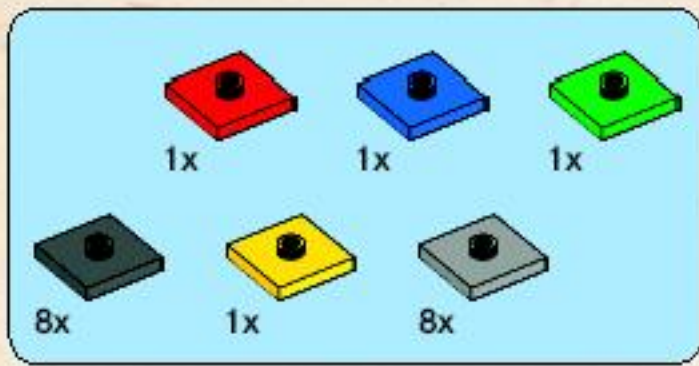

15

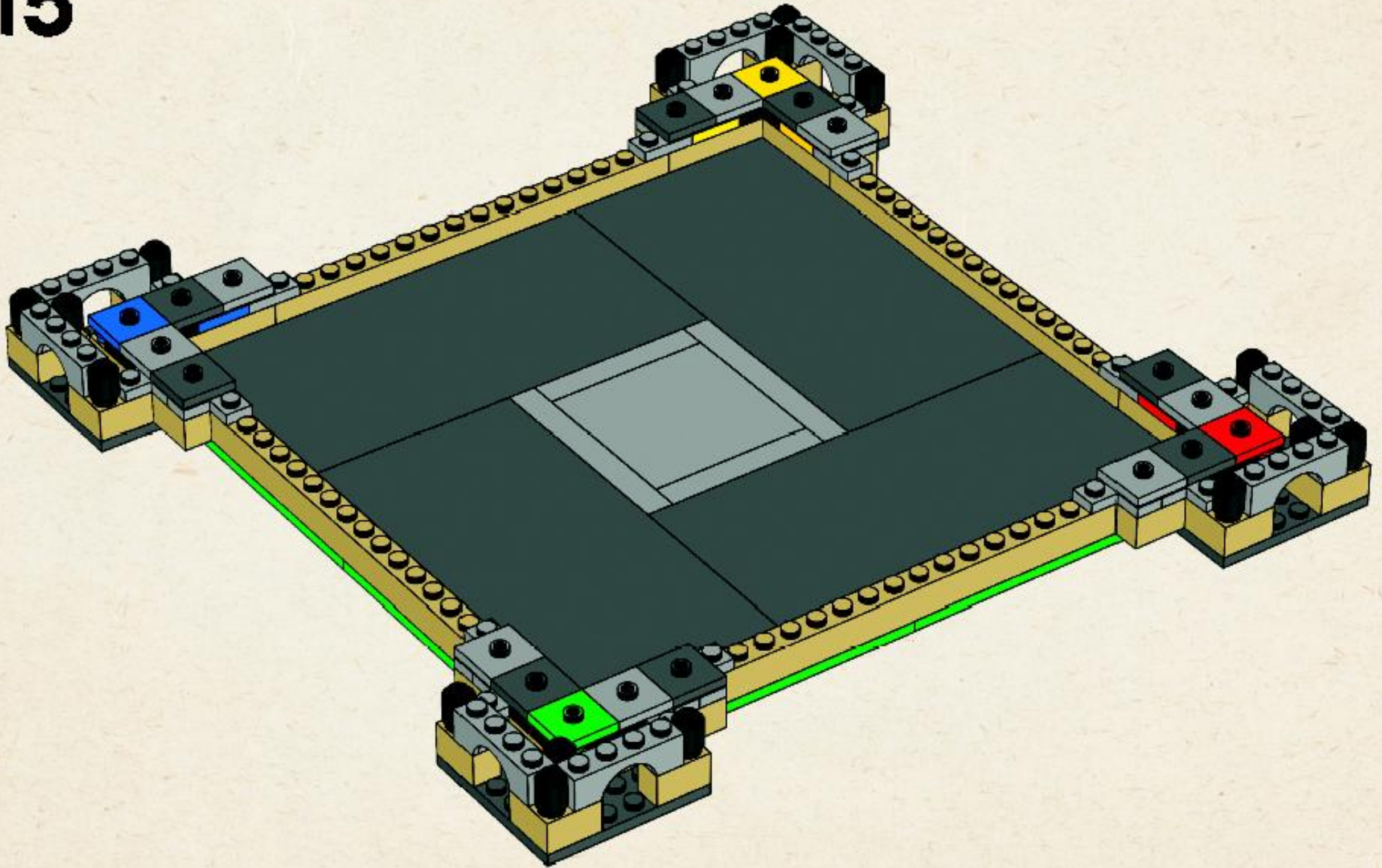



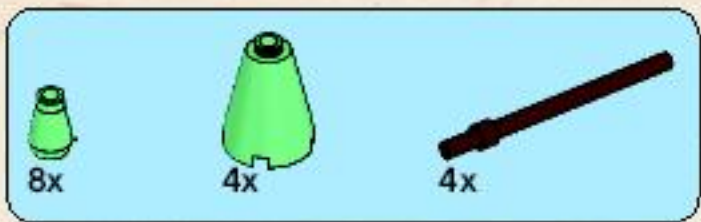

16

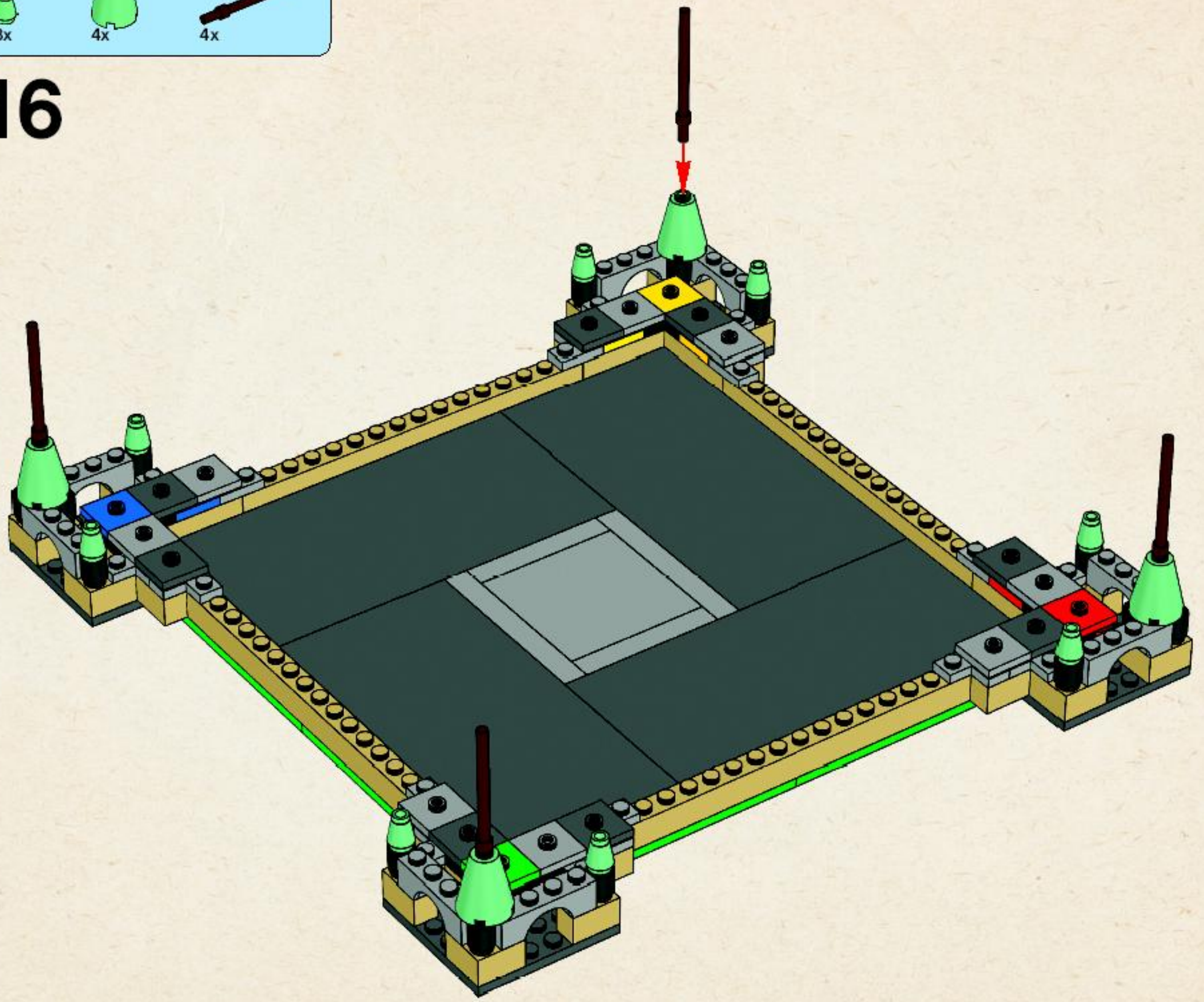



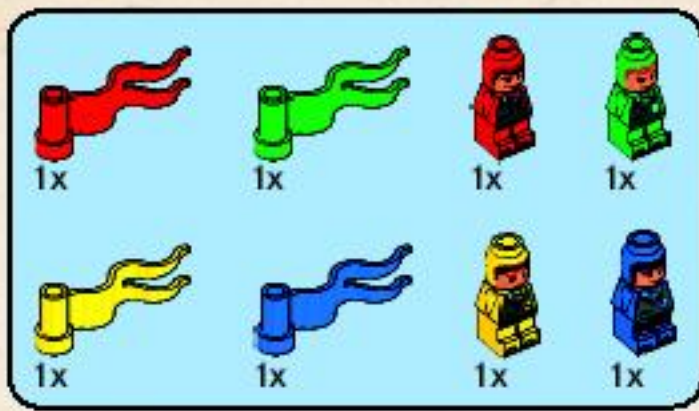

17

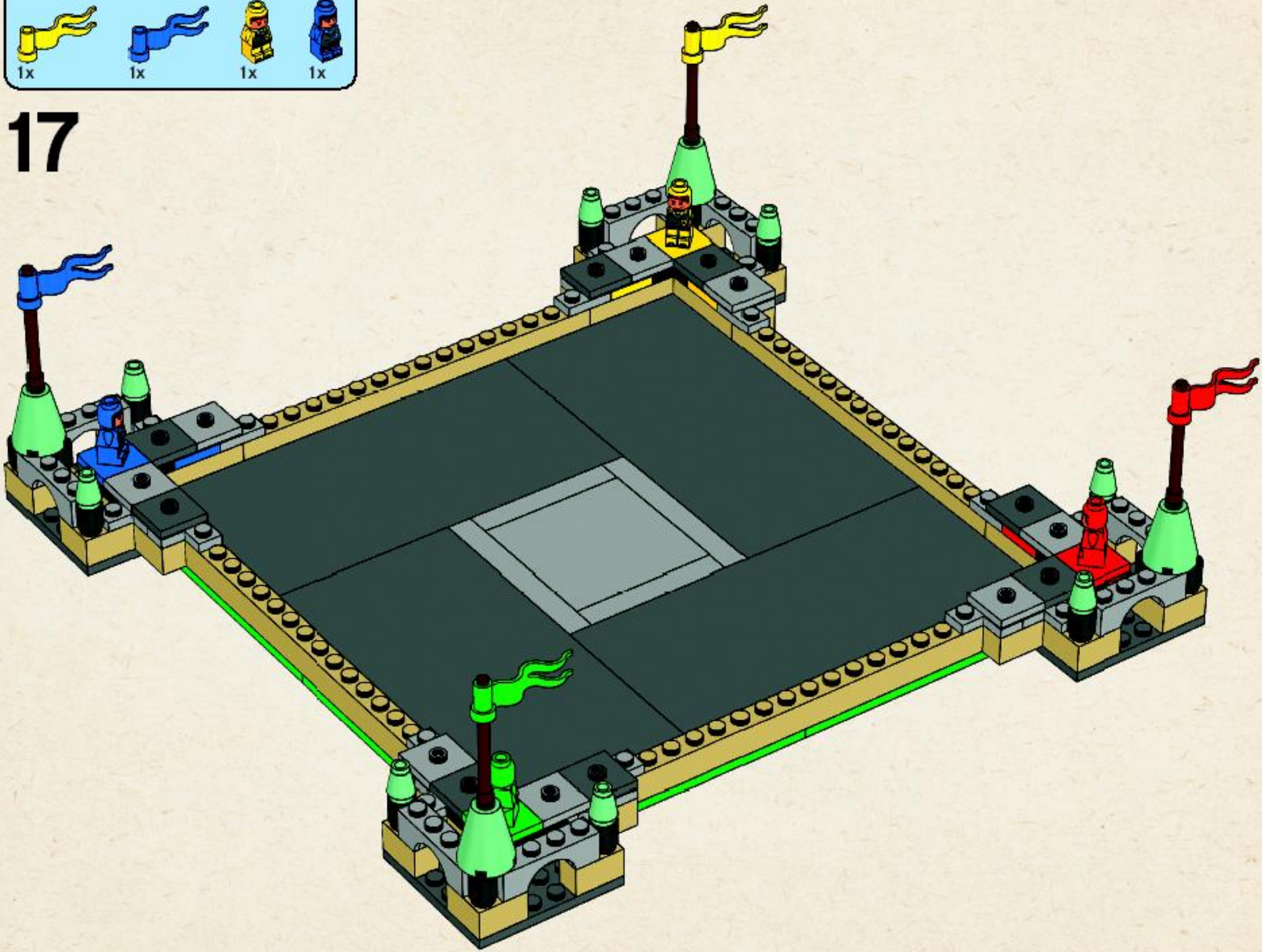



18

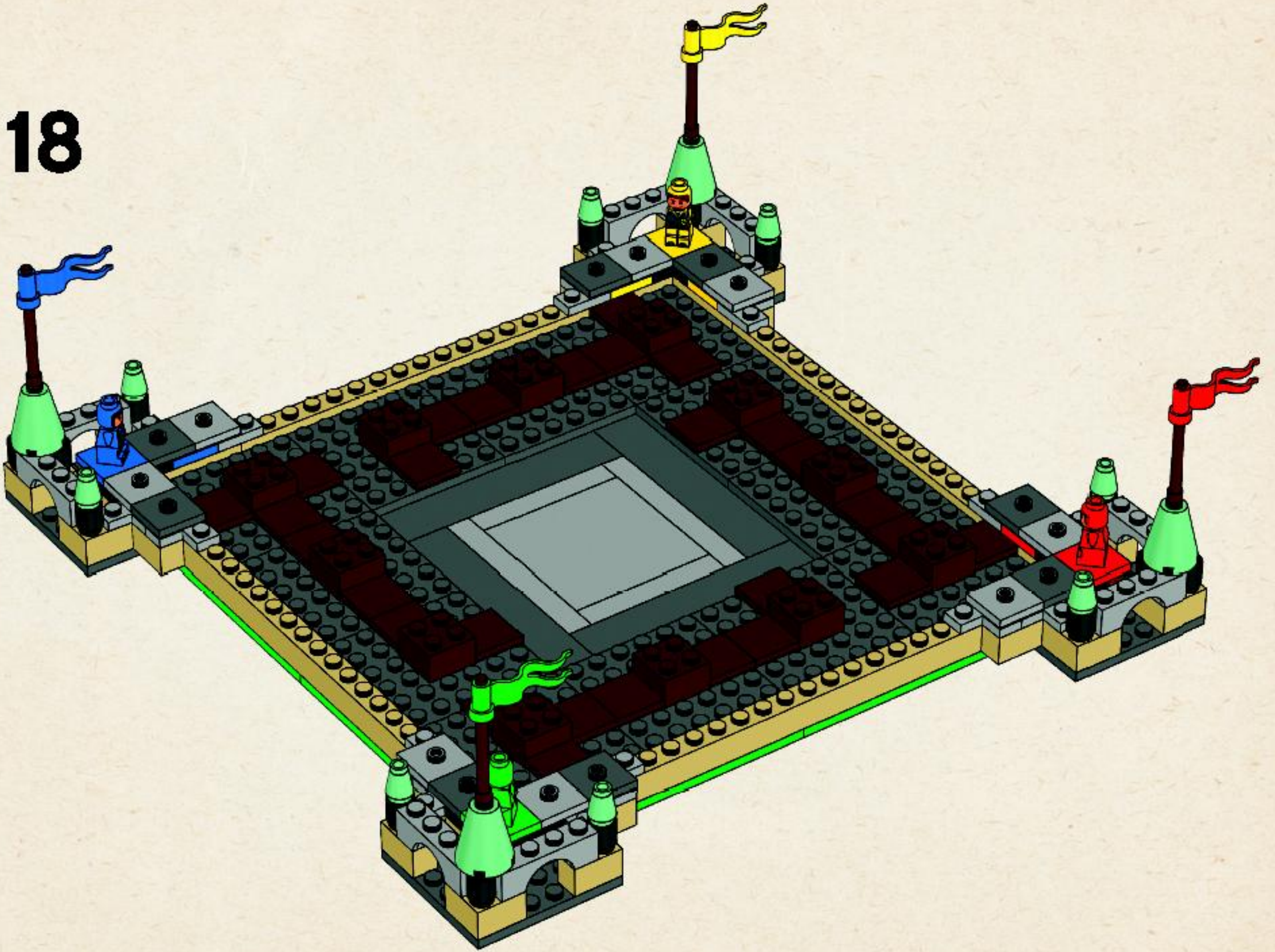



19

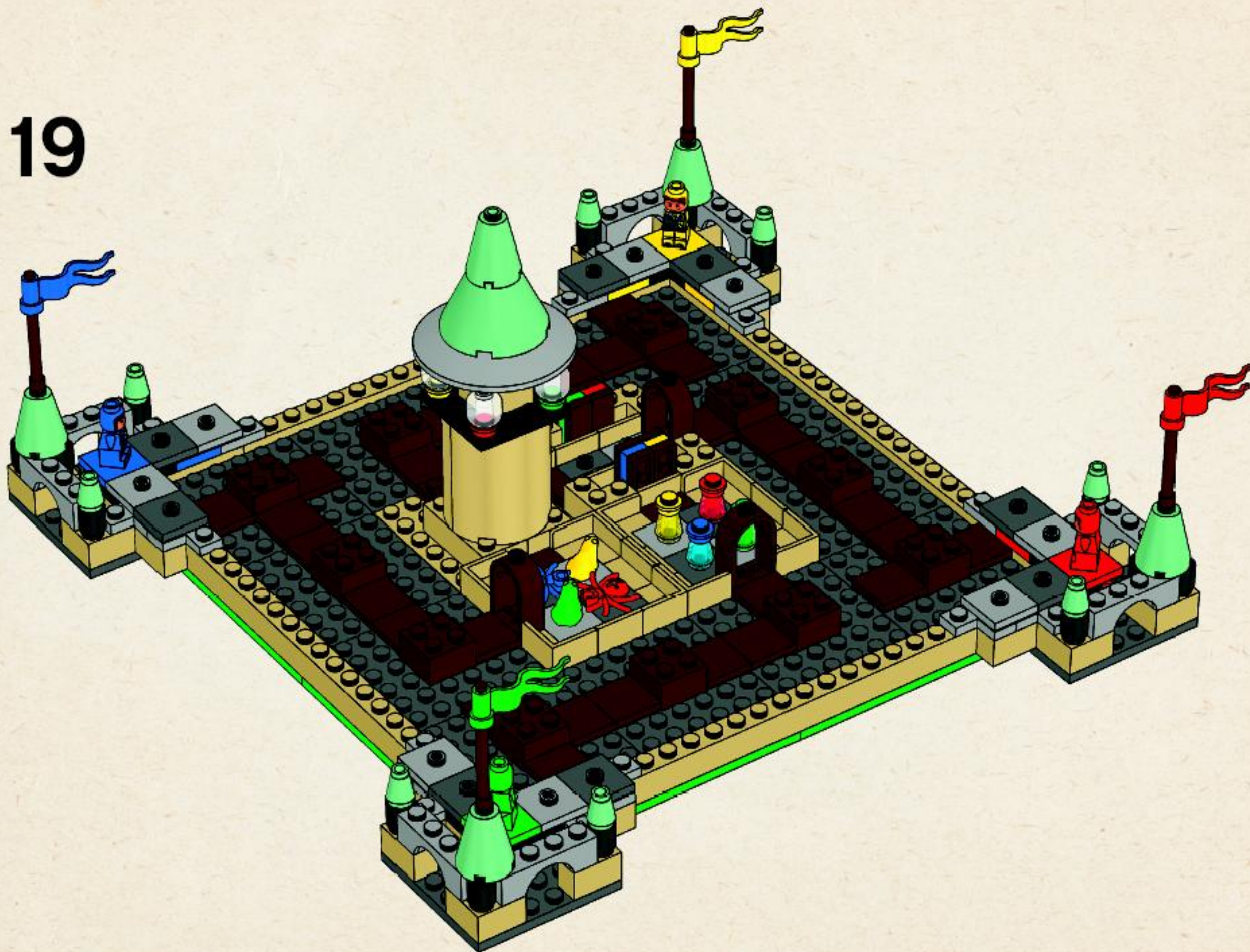



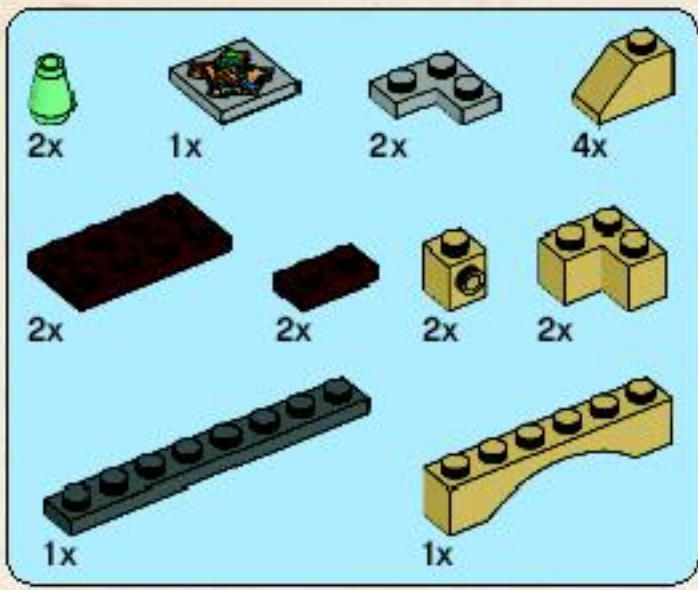

20

1

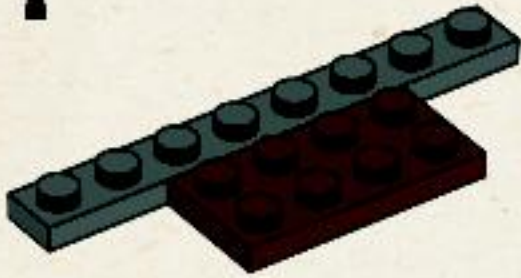

2

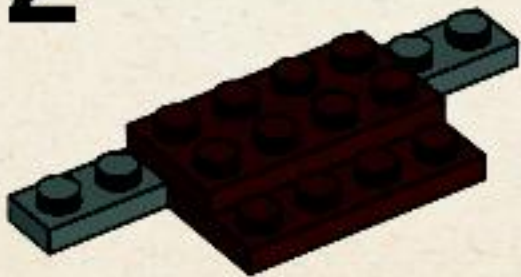

3

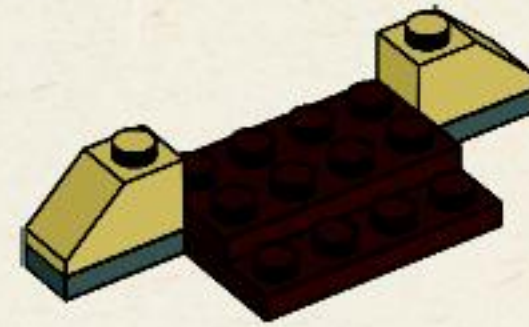

4

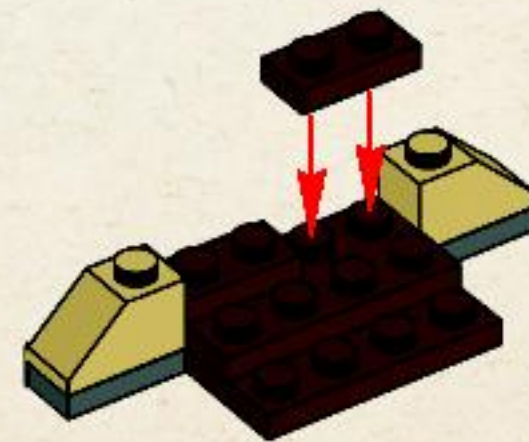







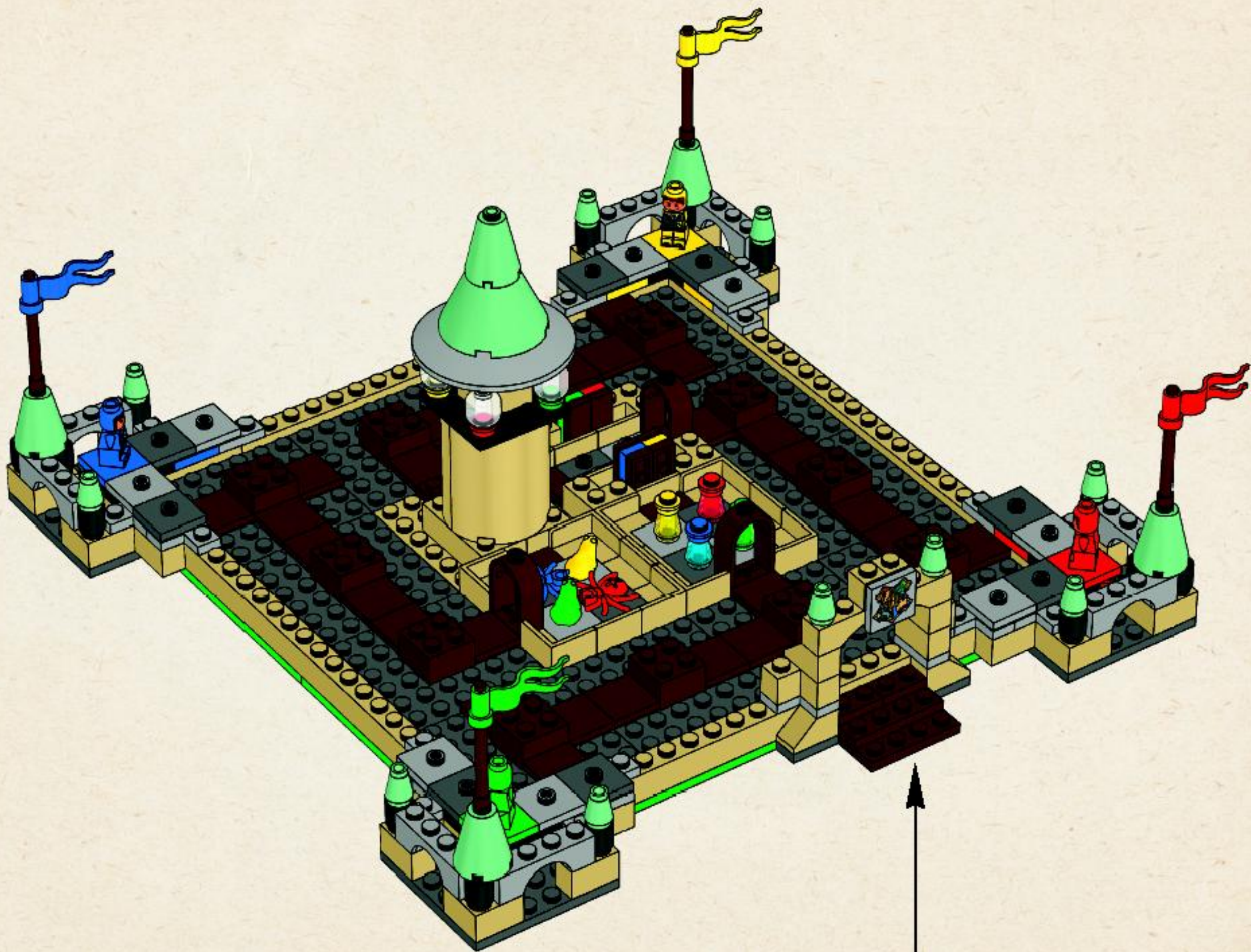









Customer Service  
Kundenservice  
Service Consommateurs  
Servicio Al Consumidor  
[www.lego.com/service](http://www.lego.com/service) or dial

00800 5346 5555 :   
1-800-422-5346 :



OUT NOW

# Harry Potter

YEARS 1-4



## THE MAGIC IS BUILDING

[WWW.MAGICISBUILDING.COM](http://WWW.MAGICISBUILDING.COM)

Wii

NINTENDO DS



PlayStation



Games for Windows



XBOX 360

XBOX LIVE

RATING PENDING

**RP**

CONTENT RATED BY ESRB

Visit [www.esrb.org](http://www.esrb.org) for rating information

LEGO HARRY POTTER: YEARS 1-4 software © 2010 TT Games Publishing Ltd. Produced by TT Games under license from the LEGO Group. LEGO, the LEGO logo, the Brick and the Knick configurations and the Minifigure are trademarks of the LEGO Group. © 2010 The LEGO Group. "PlayStation" and the "PS" Family logo are registered trademarks of Sony Computer Entertainment Inc. The PlayStation Network Logo is a service mark of Sony Computer Entertainment Inc. Wii and Nintendo DS are trademarks of Nintendo. © 2006 Nintendo. Microsoft, Xbox, Xbox 360, Xbox LIVE, and the Xbox logos are trademarks of the Microsoft group of companies and are used under license from Microsoft. Windows and the Windows Vista Start button are trademarks of the Microsoft group of companies, and "Games for Windows" and the Windows Vista Start button logo are used under license from Microsoft. All other trademarks and copyrights are the property of their respective owners. All rights reserved.



HARRY POTTER characters, names and related indicia are trademarks of and © Warner Bros. Entertainment Inc. Harry Potter Publishing Rights © JKR, WBE LOGO, WB SHIELD.™ & © Warner Bros. Entertainment Inc. (SIC)





**LEGO**

**Harry Potter**

**THE  
MAGIC CONTINUES  
OCTOBER 2010!**



**HarryPotter.LEGO.com**

LEGO, the LEGO logo and DUPLO are trademarks of the LEGO Group. ©2010 The LEGO Group. TM & © Warner Bros. Entertainment Inc. Harry Potter Publishing Rights © JKR. (s10)





3845  
Shave a Sheep  
2-4 5+ 10-15



3846  
UFO Attack  
2-4 6+ 10-15



3847  
Magma Monster  
2-4 7+ 10-20



3848  
Pirate Plank  
2-4 7+ 10-20



3849  
Orient Bazaar  
2-4 7+ 10-20



3850  
Meteor Strike  
2 7+ 10-20



3851  
Atlantis Treasure  
2-4 9+ 20-30



3862  
Harry Potter™ Hogwarts™  
2-4 8+ 20-40



games.LEGO.com







# WIN!

Go to [www.nielsen.com/LEGO](http://www.nielsen.com/LEGO) to fill out a survey for a chance to win a cool LEGO® Product. No purchase necessary. Open to all residents where not prohibited.



## [www.nielsen.com/LEGO](http://www.nielsen.com/LEGO)

### GEWINNE! WIN!

Nimm an der Umfrage auf [www.nielsen.com/](http://www.nielsen.com/) LEGO teil und hab die Chance ein cooles LEGO® Produkt zu gewinnen!

Die Teilnahme am Gewinnspiel führt zu keinerlei Kaufverpflichtungen. Teilnahme in allen nicht ausgeschlossenen Ländern möglich.

Ga naar [www.nielsen.com/LEGO](http://www.nielsen.com/LEGO), vul een enquêteformulier in en maak kans op een cool LEGO® product.

Geen aankoopverplichting. Iedereen mag deelnemen, uitgezonderd ingezetenden van landen waar een enquêteverbod geldt.

### GAGNE! 当てよう!

Visite [www.nielsen.com/LEGO](http://www.nielsen.com/LEGO) pour répondre à un questionnaire et avoir une chance de gagner un produit LEGO® très cool!

Aucune obligation d'achat. Ouvert à tous les résidents des pays autorisés.

[www.nielsen.com/LEGO](http://www.nielsen.com/LEGO)にアクセスして、アンケートにご記入ください。当選者にはレゴ製品を差し上げます。

お買い上げの必要はありません。禁止されていない限り、すべての皆様にご案内いただけます。