



# CREATOR

6913



1

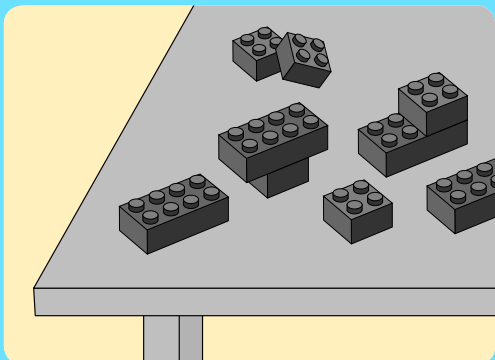
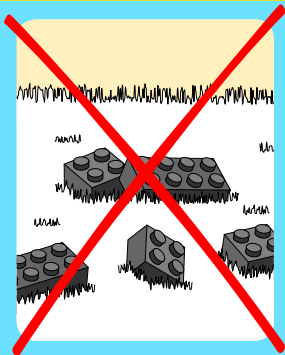

2

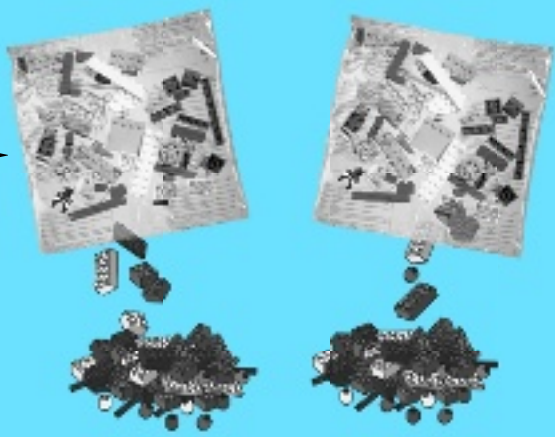

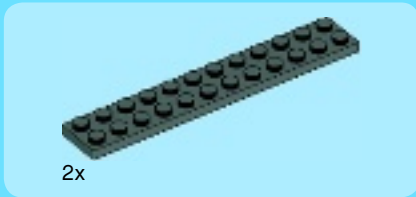
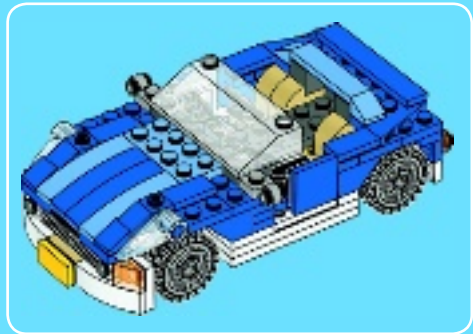

1

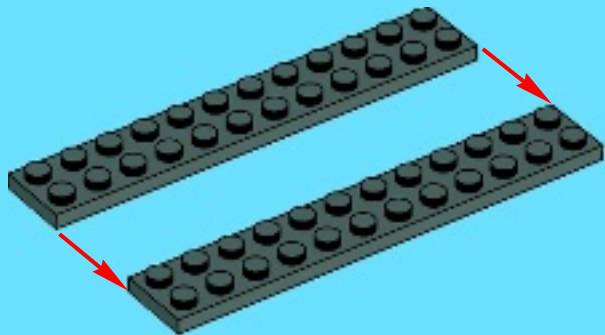



1x



1x

2

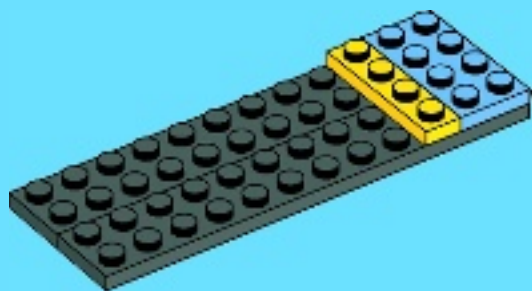

4



1x



1x

3

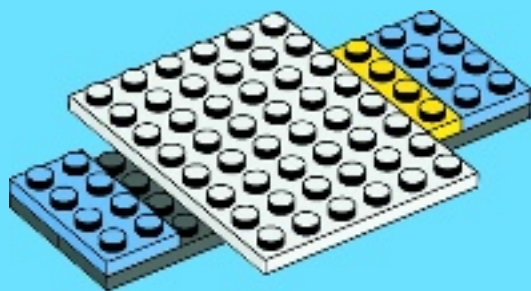



1x



1x

4





4x



4x

5



4x







2x



2x



2x

# 7

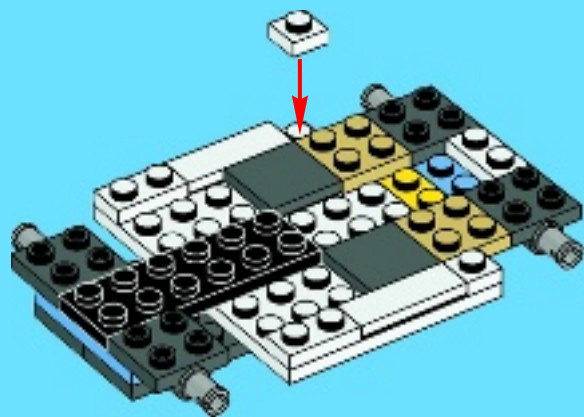



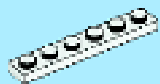

2x



2x

8

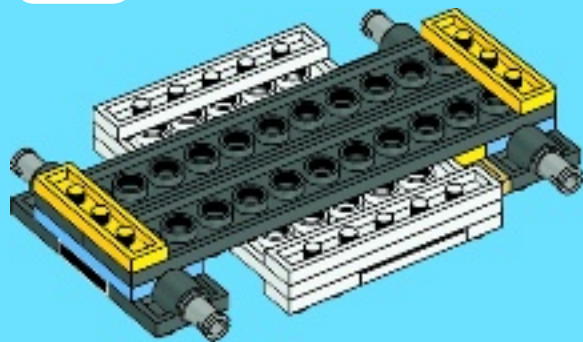



2x



1x

1

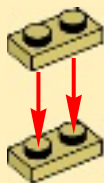

2

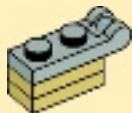

9

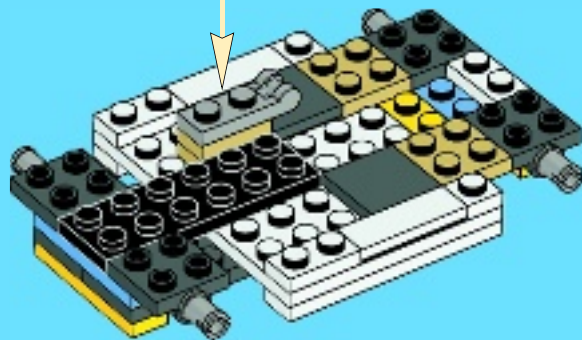



3x



1x

10

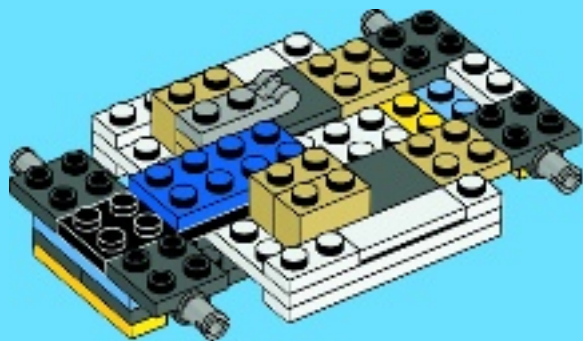



1x



2x



1x

# 11

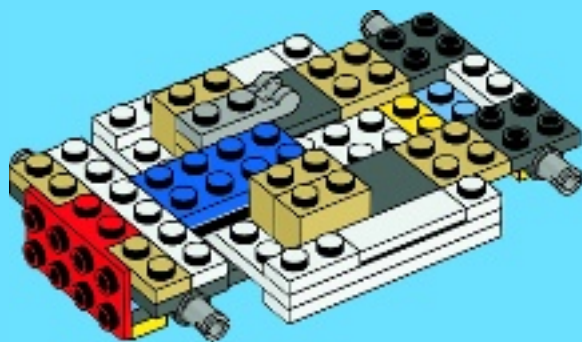



1x

12

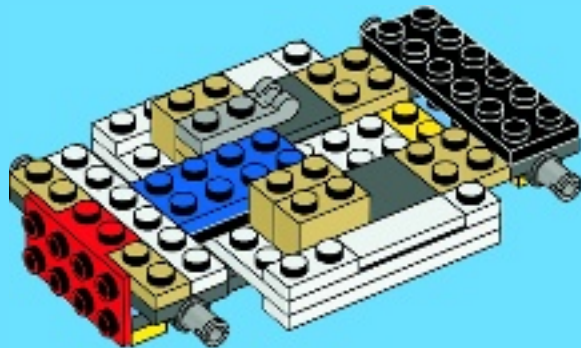



1x

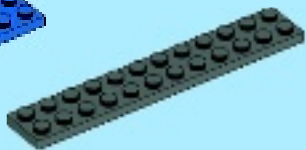

1x

# 13

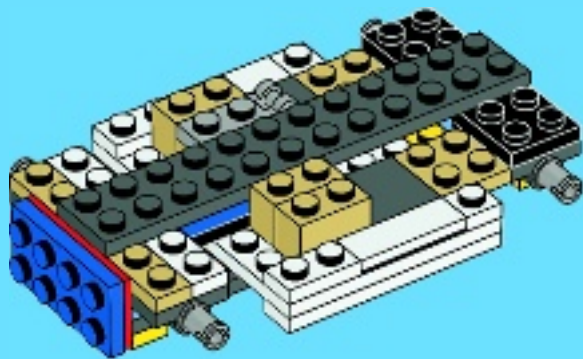

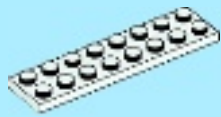

1x



1x

1

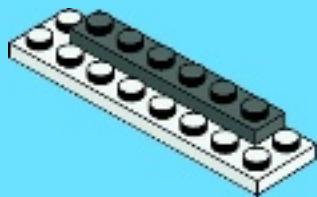

2x



2x

2

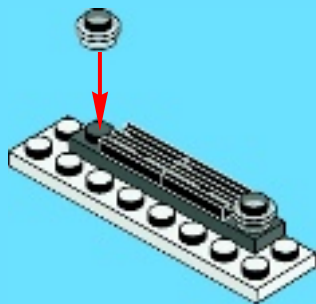



2x



1x

3

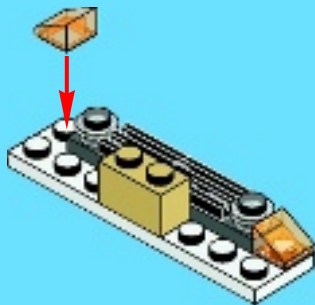

1x



2x

4

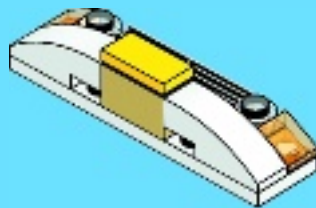



14

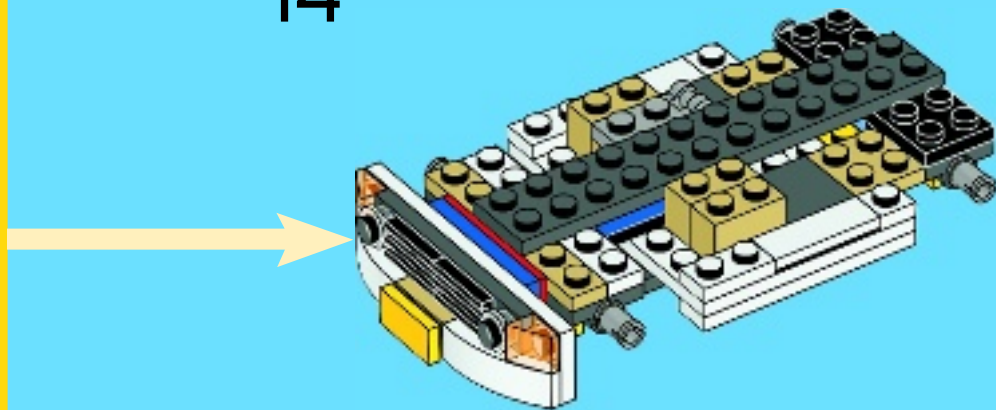



2x



2x

# 15

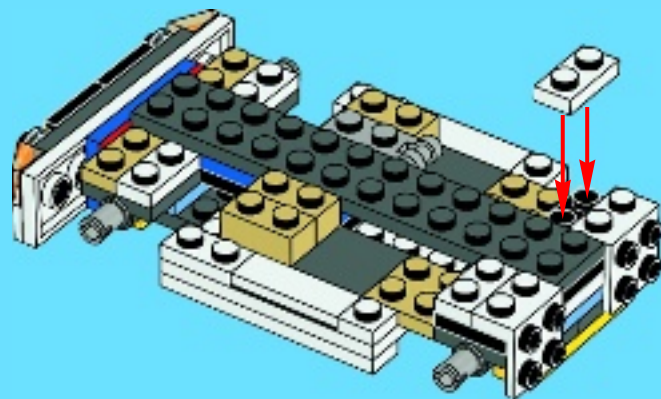



1x



4x

# 16

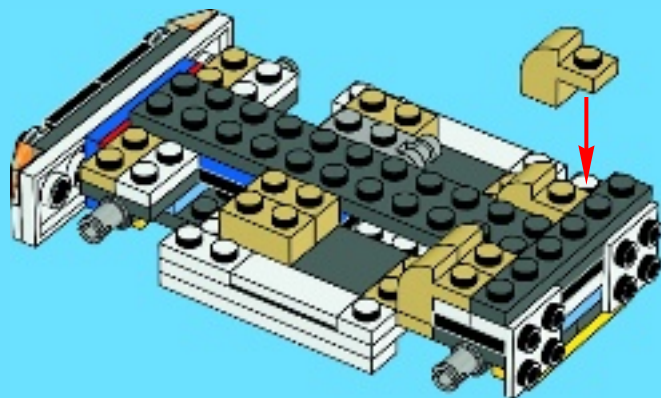



1x



2x

1



2x

2

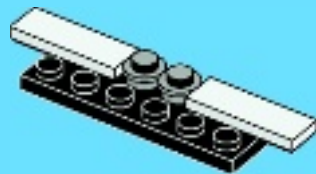



1x

3

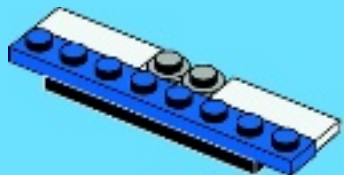

1x



2x



2x

4





17

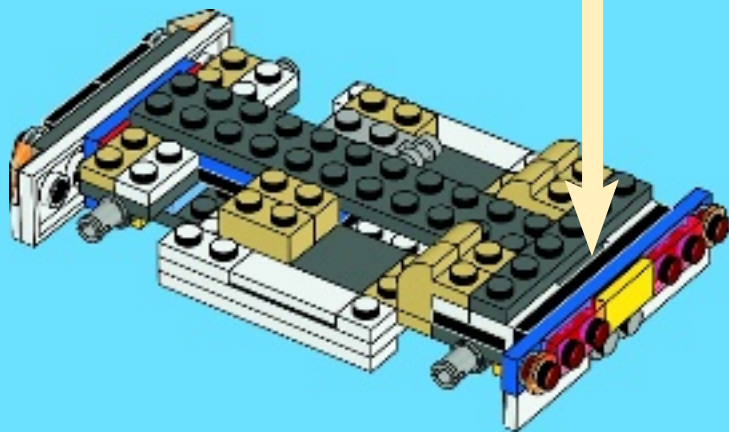



2x



2x

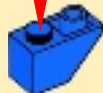

2x

# 18

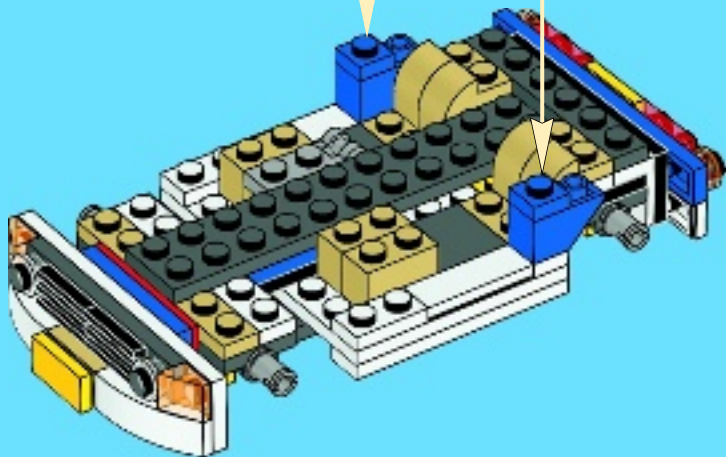



2x

19

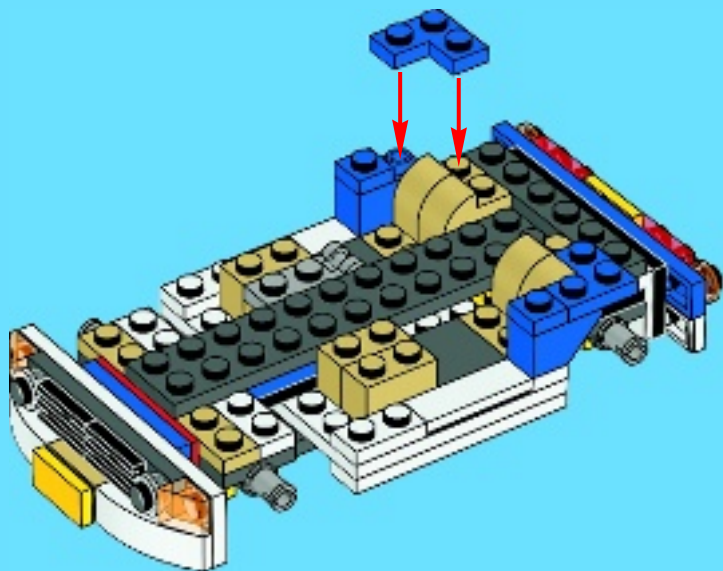



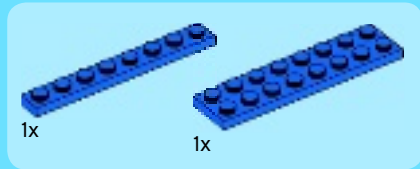

20

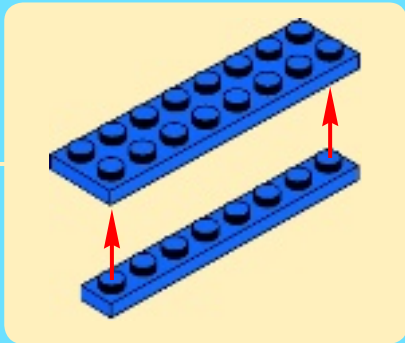
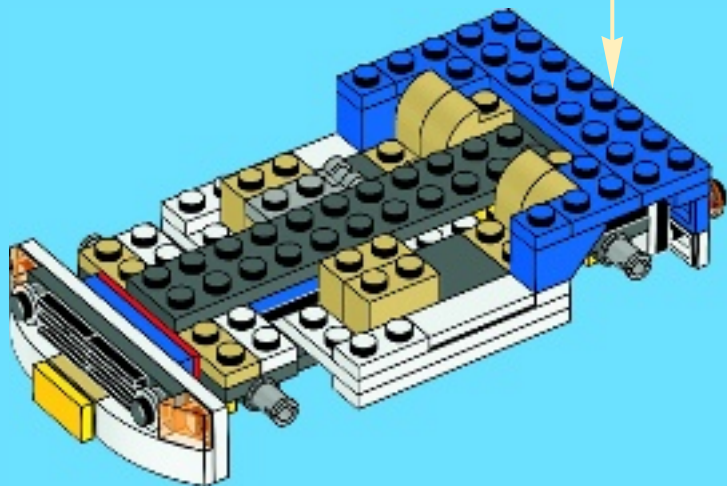



1x



1x

# 21

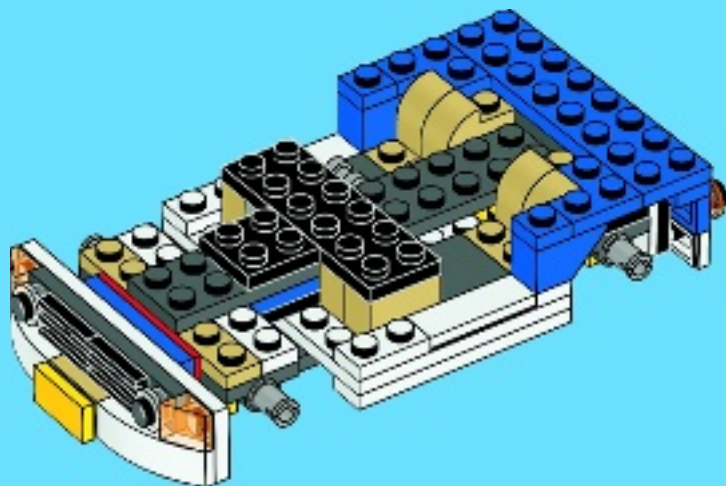



2x



4x

# 22

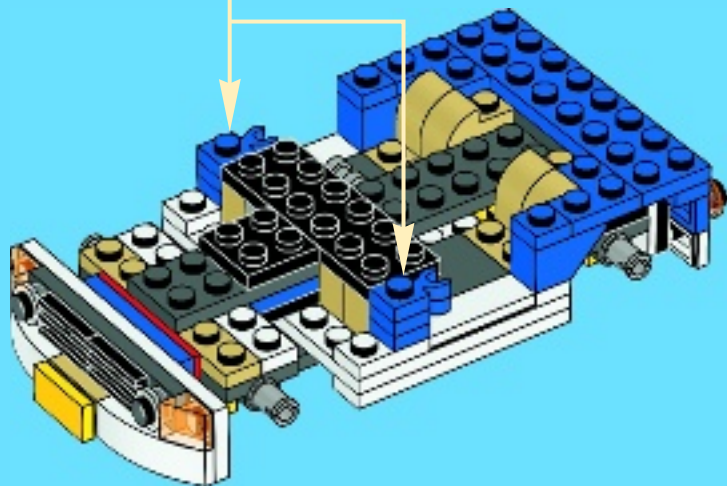
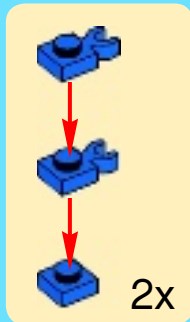



2x



2x

# 23

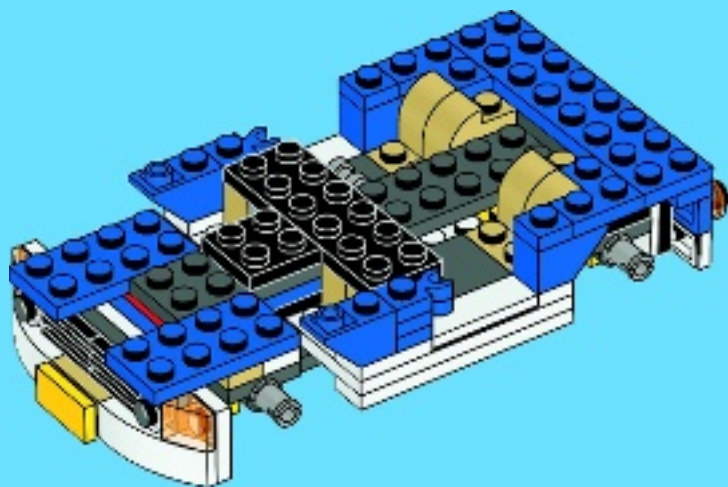



1x



2x



1x

# 24

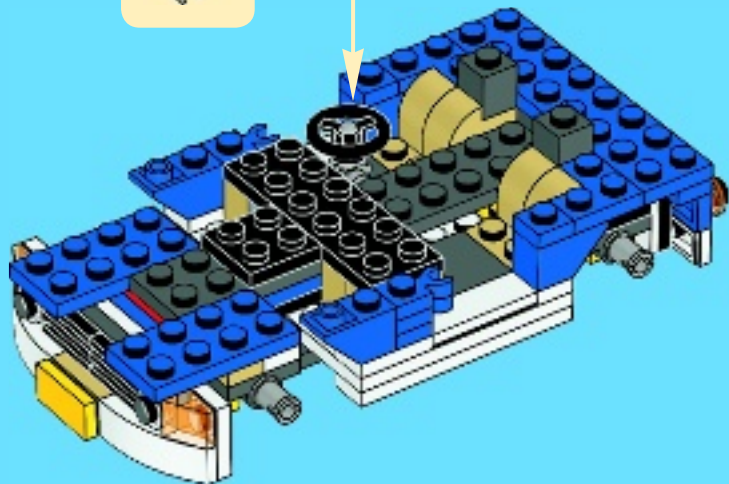
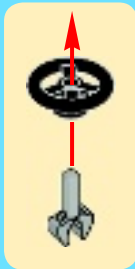



2x



1x



1x

# 25

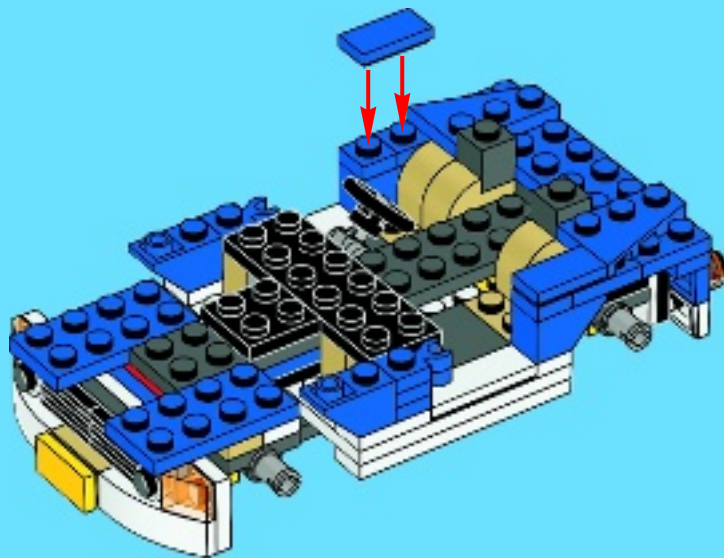



1x



2x



1x

# 26

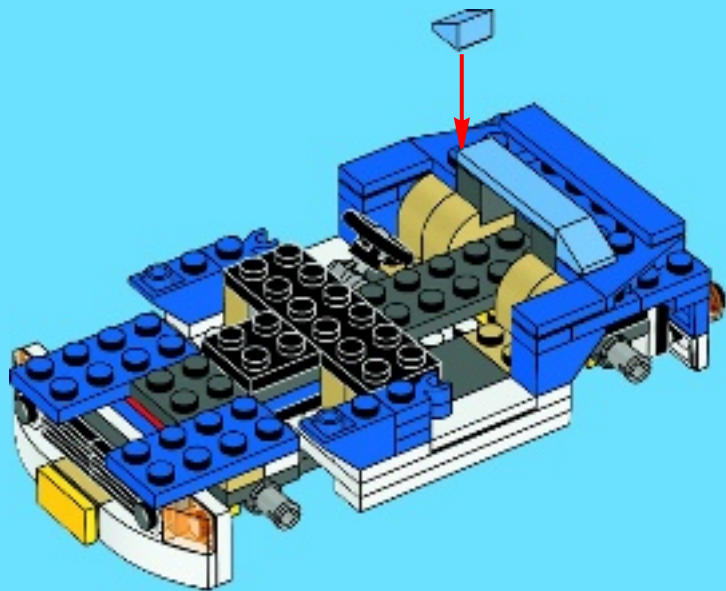



2x

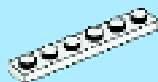

1x

# 27

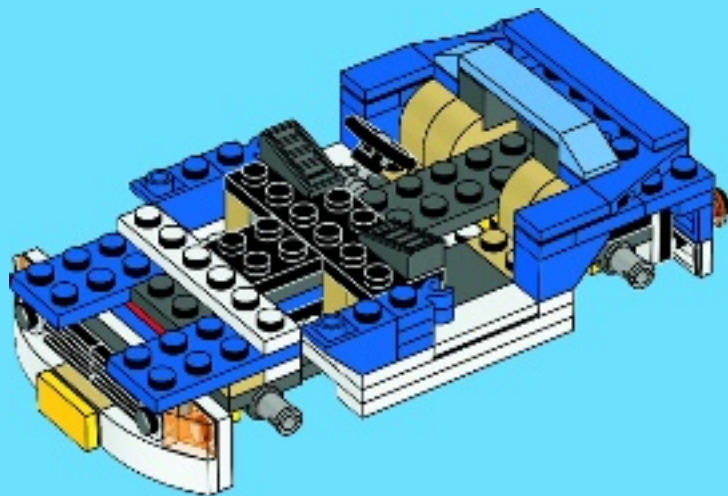





1x

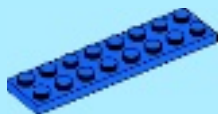

1x

28

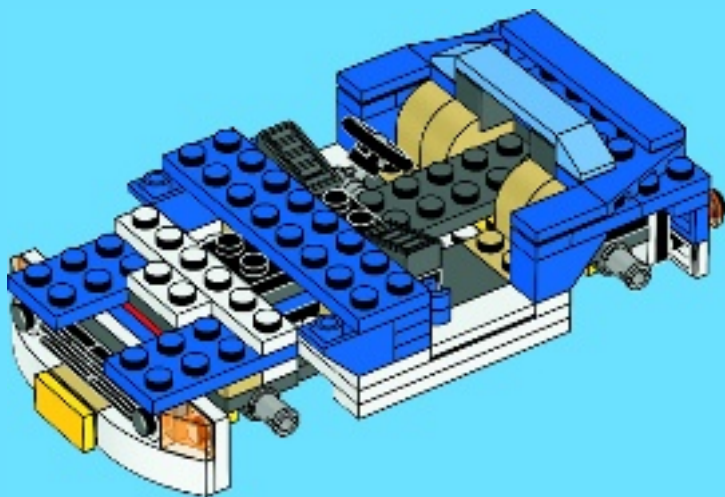



1x

29

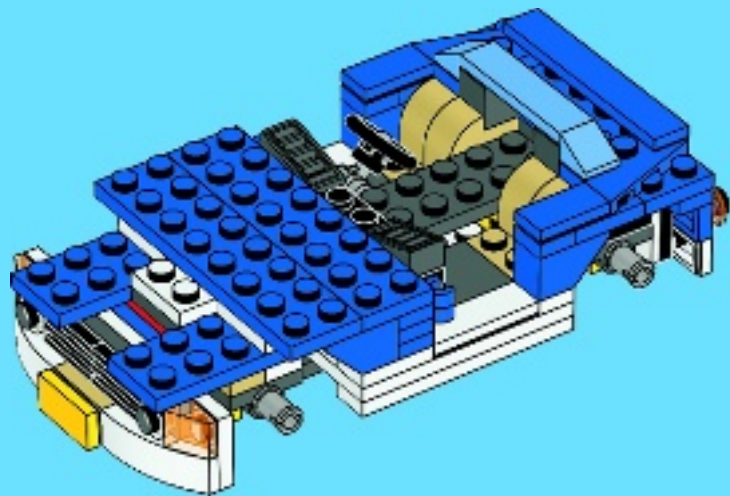



2x



2x



2x

# 30

1

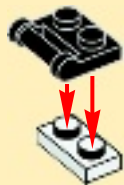

2



2x

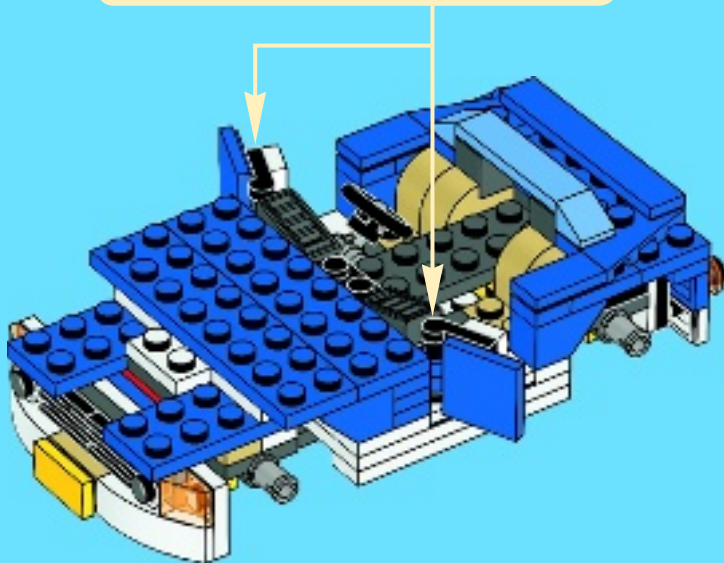



2x



1x

# 31

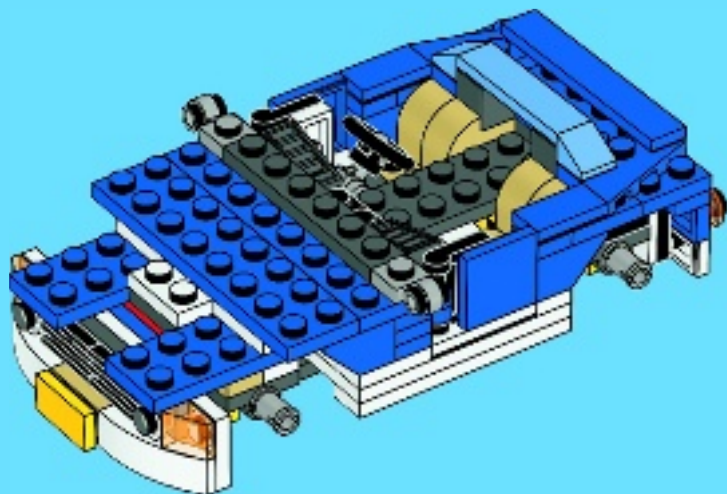



2x



2x

# 32

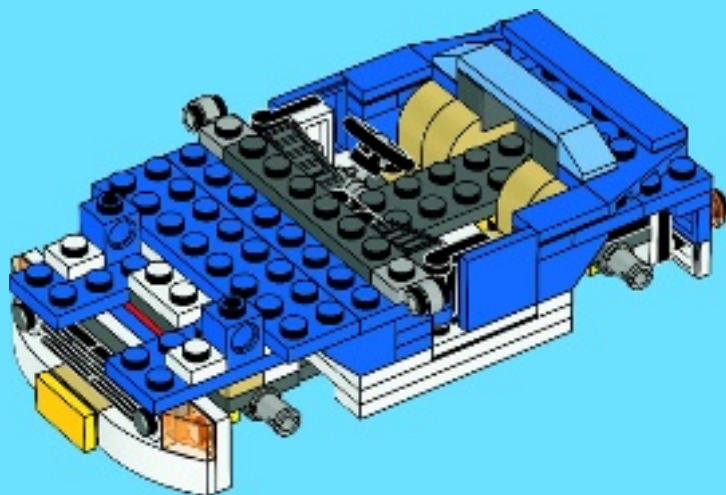



1x



2x

# 33

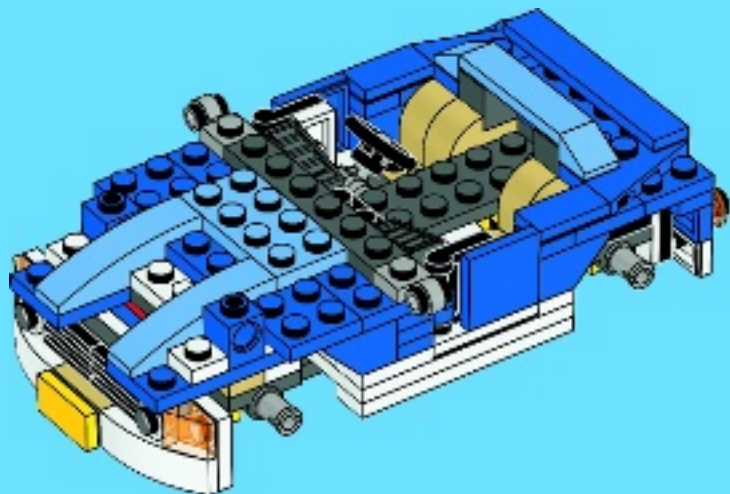



1x



2x

# 34

1



2

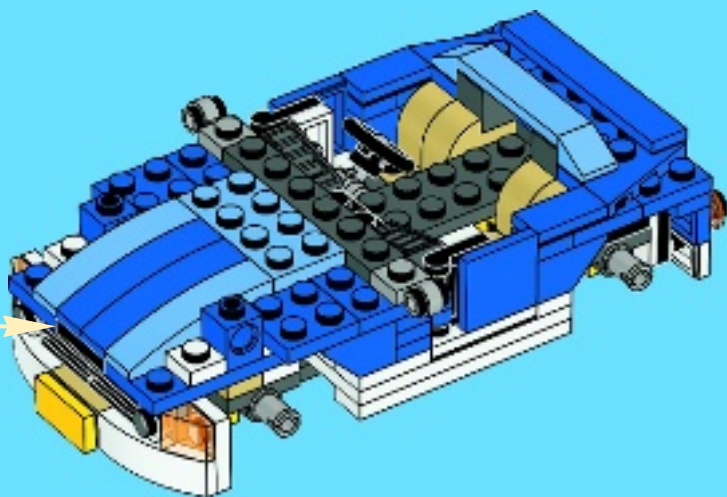
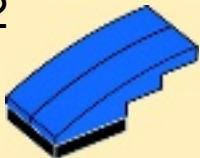



2x



4x

# 35

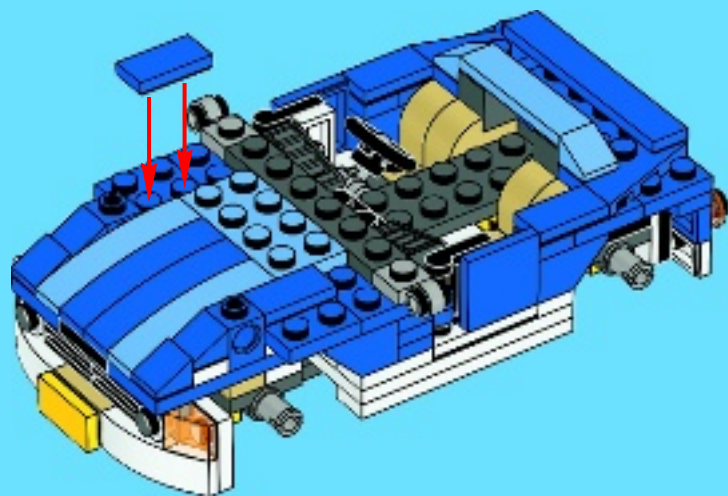



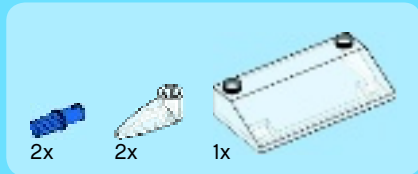

36

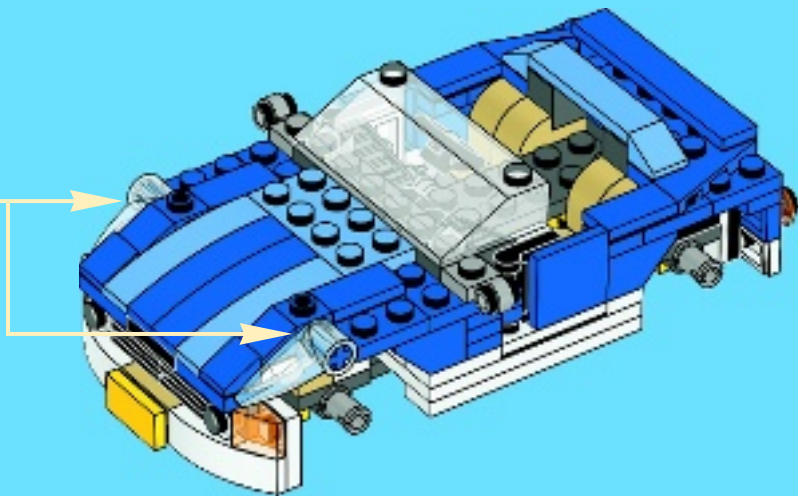
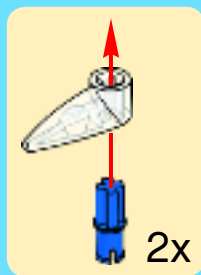



4x



4x

# 37

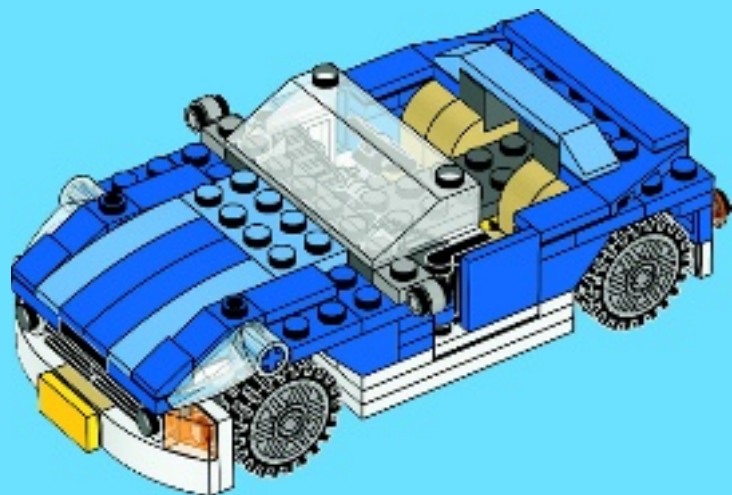



2x  
4615649



2x  
4249112



4x  
302401



8x  
302301



4x  
4558168



4x  
366601



1x  
303401



1x  
303601



4x  
4109995



4x  
4273526



4x  
4113917



2x  
4114084



1x  
4616800



1x  
4498156



4x  
4613257



2x  
4206482



2x  
4119014



4x  
4504380



4x  
366523



1x  
4118785



2x  
346023



3x  
303423



1x  
4498155



2x  
242023



4x  
302423



4x  
306923



2x  
306823



4x  
302023



2x  
4540048



2x  
4244369



2x  
4222960



2x  
4201019



2x  
241226



2x  
4225201



4x  
4541455



1x  
4153044



2x  
302226



4x  
379526



2x  
3005740



2x  
4611639



1x  
4542700



2x  
306924



3x  
371024



2x  
4632575



1x  
4515369



2x  
4211525



4x  
4499259



1x  
4542590



4x  
4211807



2x  
4565363



2x  
4649758



3x  
4650970



1x  
4597999



2x  
4211098



2x  
4540386



2x  
4211055



4x  
4196768



3x  
4211056



3x  
4211067

Customer Service  
Kundenservice  
Service Consommateurs  
Servicio Al Consumidor

[www.lego.com/service](http://www.lego.com/service) or dial



: 00800 5346 5555

: 1-800-422-5346



# CREATOR



6912



7291



6914



7292



**LEGO** CREATOR



[creator.LEGO.com/designers](http://creator.LEGO.com/designers)

**3** IN 1



# 3 IN 1 + 1

Join the LEGO® Club and be the first to get access to building instructions for an extra model

Inscris-toi au LEGO® Club et sois le premier à accéder aux instructions de montage pour un modèle supplémentaire

Werde Mitglied im LEGO® Club und erhalte als einer der Ersten eine Bauanleitung für ein Extra-Modell!

Únete a LEGO® Club y sé el primero en acceder a las instrucciones de construcción de otro modelo más

Torna-te membro da LEGO® Club e sê o primeiro a ter acesso a instruções de construção para um modelo extra

Csatlakozz a LEGO® Clubhoz és légy te az első, aki hozzáférhet egy extra modell építési utasításához



creator.LEGO.com



CREATOR



[creator.LEGO.com/game](http://creator.LEGO.com/game)



# WIN!

Go to [www.LEGOsurvey.com/product](http://www.LEGOsurvey.com/product) to fill out a survey for a chance to win a cool LEGO® Product.

No purchase necessary.

Open to all residents where not prohibited.



## [www.LEGOsurvey.com/product](http://www.LEGOsurvey.com/product)

### GEWINNE!

Nimm an der Umfrage auf [www.LEGOsurvey.com/product](http://www.LEGOsurvey.com/product) teil und hab die Chance ein cooles LEGO® Produkt zu gewinnen!

Die Teilnahme am Gewinnspiel führt zu keinerlei Kaufverpflichtungen. Teilnahme in allen nicht ausgeschlossenen Ländern möglich.

### WIN!

Ga naar [www.LEGOsurvey.com/product](http://www.LEGOsurvey.com/product), vul een enquêteformulier in en maak kans op een cool LEGO® product.

Geen aankoopverplichting. Iedereen mag deelnemen, uitgezonderd ingezetenden van landen waar een enquêteverbod geldt.

### GAGNE!

Visite [www.LEGOsurvey.com/product](http://www.LEGOsurvey.com/product) pour répondre à un questionnaire et avoir une chance de gagner un produit LEGO® très cool!

Aucune obligation d'achat. Ouvert à tous les résidents des pays autorisés.

### 当てよう!

[www.LEGOsurvey.com/product](http://www.LEGOsurvey.com/product) にアクセスして、アンケートにご記入ください。当選者にはレゴ®製品を差し上げます。

お買い上げの必要はありません。禁止されていない限り、すべての皆様にご利用いただけます。



[www.LEGO.com](http://www.LEGO.com)

6008417 / 6008500

LEGO and the LEGO logo are trademarks of the/son des marques de commerce de/son marcas registradas de LEGO Group. ©2012 The LEGO Group.